

UNITED STATES DEPARTMENT OF COMMERCE • Luther H. Hodges, *Secretary*  
NATIONAL BUREAU OF STANDARDS • A. V. Astin, *Director*

# Handbook of Mathematical Functions

With

Formulas, Graphs, and Mathematical Tables

Edited by  
Milton Abramowitz and Irene A. Stegun



National Bureau of Standards  
Applied Mathematics Series • 55

Issued June 1964

Tenth Printing, December 1972, with corrections

---

For sale by the Superintendent of Documents, U.S. Government Printing Office  
Washington, D.C. 20402 - Price \$11.35 domestic postpaid, or \$10.50 GPO Bookstore

The text relating to physical constants and conversion factors (page 6) has been modified to take into account the newly adopted Système International d'Unites (SI).

#### ERRATA NOTICE

The original printing of this Handbook (June 1964) contained errors that have been corrected in the reprinted editions. These corrections are marked with an asterisk (\*) for identification. The errors occurred on the following pages: 2-3, 6-8, 10, 15, 19-20, 25, 76, 85, 91, 102, 187, 189-197, 218, 223, 225, 233, 250, 255, 260-263, 268, 271-273, 292, 302, 328, 332, 333-337, 362, 365, 415, 423, 438-440, 443, 445, 447, 449, 451, 484, 498, 505-506, 509-510, 543, 556, 558, 562, 571, 595, 599, 600, 722-723, 739, 742, 744, 746, 752, 756, 760-765, 774, 777-785, 790, 797, 801, 822-823, 832, 835, 844, 886-889, 897, 914, 915, 920, 930-931, 936, 940-941, 944-950, 953, 960, 963, 989-990, 1010, 1026.

Originally issued June 1964. Second printing, November 1964. Third printing, March 1965. Fourth printing, December 1965. Fifth printing, August 1966. Sixth printing, November 1967. Seventh printing, May 1968. Eighth printing, 1969. Ninth printing, November 1970.

Library of Congress Catalog Card Number: 64-60036



# Preface

The present volume is an outgrowth of a Conference on Mathematical Tables held at Cambridge, Mass., on September 15-16, 1954, under the auspices of the National Science Foundation and the Massachusetts Institute of Technology. The purpose of the meeting was to evaluate the need for mathematical tables in the light of the availability of large scale computing machines. It was the consensus of opinion that in spite of the increasing use of the new machines the basic need for tables would continue to exist.

Numerical tables of mathematical functions are in continual demand by scientists and engineers. A greater variety of functions and higher accuracy of tabulation are now required as a result of scientific advances and, especially, of the increasing use of automatic computers. In the latter connection, the tables serve mainly for preliminary surveys of problems before programming for machine operation. For those without easy access to machines, such tables are, of course, indispensable.

Consequently, the Conference recognized that there was a pressing need for a modernized version of the classical tables of functions of Jahnke-Emde. To implement the project, the National Science Foundation requested the National Bureau of Standards to prepare such a volume and established an Ad Hoc Advisory Committee, with Professor Philip M. Morse of the Massachusetts Institute of Technology as chairman, to advise the staff of the National Bureau of Standards during the course of its preparation. In addition to the Chairman, the Committee consisted of A. Erdelyi, M. C. Gray, N. Metropolis, J. B. Rosser, H. C. Thacher, Jr., John Todd, C. B. Tompkins, and J. W. Tukey.

The primary aim has been to include a maximum of useful information within the limits of a moderately large volume, with particular attention to the needs of scientists in all fields. An attempt has been made to cover the entire field of special functions. To carry out the goal set forth by the Ad Hoc Committee, it has been necessary to supplement the tables by including the mathematical properties that are important in computation work, as well as by providing numerical methods which demonstrate the use and extension of the tables.

The Handbook was prepared under the direction of the late Milton Abramowitz, and Irene A. Stegun. Its success has depended greatly upon the cooperation of many mathematicians. Their efforts together with the cooperation of the Ad Hoc Committee are greatly appreciated. The particular contributions of these and other individuals are acknowledged at appropriate places in the text. The sponsorship of the National Science Foundation for the preparation of the material is gratefully recognized.

It is hoped that this volume will not only meet the needs of all table users but will in many cases acquaint its users with new functions.

ALLEN V. ASTIN, *Director*

June 1964  
Washington, D.C.

## Preface to the Ninth Printing

The enthusiastic reception accorded the "Handbook of Mathematical Functions" is little short of unprecedented in the long history of mathematical tables that began when John Napier published his tables of logarithms in 1614. Only four and one-half years after the first copy came from the press in 1964, Myron Tribus, the Assistant Secretary of Commerce for Science and Technology, presented the 100,000th copy of the Handbook to Lee A. DuBridge, then Science Advisor to the President. Today, total distribution is approaching the 150,000 mark at a scarcely diminished rate.

The success of the Handbook has not ended our interest in the subject. On the contrary, we continue our close watch over the growing and changing world of computation and to discuss with outside experts and among ourselves the various proposals for possible extension or supplementation of the formulas, methods and tables that make up the Handbook.

In keeping with previous policy, a number of errors discovered since the last printing have been corrected. Aside from this, the mathematical tables and accompanying text are unaltered. However, some noteworthy changes have been made in Chapter 2: Physical Constants and Conversion Factors, pp. 6-8. The table on page 7 has been revised to give the values of physical constants obtained in a recent reevaluation; and pages 6 and 8 have been modified to reflect changes in definition and nomenclature of physical units and in the values adopted for the acceleration due to gravity in the revised Potsdam system.

The record of continuing acceptance of the Handbook, the praise that has come from all quarters, and the fact that it is one of the most-quoted scientific publications in recent years are evidence that the hope expressed by Dr. Astin in his Preface is being amply fulfilled.

LEWIS M. BRANSCOMB, *Director*  
National Bureau of Standards

November 1970

# Foreword

This volume is the result of the cooperative effort of many persons and a number of organizations. The National Bureau of Standards has long been turning out mathematical tables and has had under consideration, for at least 10 years, the production of a compendium like the present one. During a Conference on Tables, called by the NBS Applied Mathematics Division on May 15, 1952, Dr. Abramowitz of that Division mentioned preliminary plans for such an undertaking, but indicated the need for technical advice and financial support.

The Mathematics Division of the National Research Council has also had an active interest in tables; since 1943 it has published the quarterly journal, "Mathematical Tables and Aids to Computation" (MTAC), editorial supervision being exercised by a Committee of the Division.

Subsequent to the NBS Conference on Tables in 1952 the attention of the National Science Foundation was drawn to the desirability of financing activity in table production. With its support a 2-day Conference on Tables was called at the Massachusetts Institute of Technology on September 15-16, 1954, to discuss the needs for tables of various kinds. Twenty-eight persons attended, representing scientists and engineers using tables as well as table producers. This conference reached consensus on several conclusions and recommendations, which were set forth in the published Report of the Conference. There was general agreement, for example, "that the advent of high-speed computing equipment changed the task of table making but definitely did not remove the need for tables". It was also agreed that "an outstanding need is for a Handbook of Tables for the Occasional Computer, with tables of usually encountered functions and a set of formulas and tables for interpolation and other techniques useful to the occasional computer". The Report suggested that the NBS undertake the production of such a Handbook and that the NSF contribute financial assistance. The Conference elected, from its participants, the following Committee: P. M. Morse (Chairman), M. Abramowitz, J. H. Curtiss, R. W. Hamming, D. H. Lehmer, C. B. Tompkins, J. W. Tukey, to help implement these and other recommendations.

The Bureau of Standards undertook to produce the recommended tables and the National Science Foundation made funds available. To provide technical guidance to the Mathematics Division of the Bureau, which carried out the work, and to provide the NSF with independent judgments on grants for the work, the Conference Committee was reconstituted as the Committee on Revision of Mathematical Tables of the Mathematics Division of the National Research Council. This, after some changes of membership, became the Committee which is signing this Foreword. The present volume is evidence that Conferences can sometimes reach conclusions and that their recommendations sometimes get acted on.

Active work was started at the Bureau in 1956. The overall plan, the selection of authors for the various chapters, and the enthusiasm required to begin the task were contributions of Dr. Abramowitz. Since his untimely death, the effort has continued under the general direction of Irene A. Stegun. The workers at the Bureau and the members of the Committee have had many discussions about content, style and layout. Though many details have had to be argued out as they came up, the basic specifications of the volume have remained the same as were outlined by the Massachusetts Institute of Technology Conference of 1954.

The Committee wishes here to register its commendation of the magnitude and quality of the task carried out by the staff of the NBS Computing Section and their expert collaborators in planning, collecting and editing these Tables, and its appreciation of the willingness with which its various suggestions were incorporated into the plans. We hope this resulting volume will be judged by its users to be a worthy memorial to the vision and industry of its chief architect, Milton Abramowitz. We regret he did not live to see its publication.

P. M. MORSE, *Chairman.*

A. ERDÉLYI

M. C. GRAY

N. C. METROPOLIS

J. B. ROSSER

H. C. THACHER, JR.

JOHN TODD

C. B. TOMPKINS

J. W. TUKEY.

## Contents

|   | Page |
|---|------|
| Preface . . . . .   | III  |
| Foreword . . . . .  | V    |
| Introduction . . . . .  | IX   |
| 1. Mathematical Constants . . . . .                           | 1    |
| DAVID S. LIEPMAN  |      |
| 2. Physical Constants and Conversion Factors . . . . .        | 5    |
| A. G. McNISH  |      |
| 3. Elementary Analytical Methods . . . . .                    | 9    |
| MILTON ABRAMOWITZ   |      |
| 4. Elementary Transcendental Functions . . . . .              | 65   |
| Logarithmic, Exponential, Circular and Hyperbolic Functions   |      |
| RUTH ZUCKER   |      |
| 5. Exponential Integral and Related Functions . . . . .       | 227  |
| WALTER GAUTSCHI and WILLIAM F. CAHILL                         |      |
| 6. Gamma Function and Related Functions. . . . .              | 253  |
| PHILIP J. DAVIS   |      |
| 7. Error Function and Fresnel Integrals . . . . .             | 295  |
| WALTER GAUTSCHI   |      |
| 8. Legendre Functions . . . . .                               | 331  |
| IRENE A. STEGUN   |      |
| 9. Bessel Functions of Integer Order . . . . .                | 355  |
| F. W. J. OLVER  |      |
| 10. Bessel Functions of Fractional Order. . . . .             | 435  |
| H. A. ANTOSIEWICZ   |      |
| 11. Integrals of Bessel Functions . . . . .                   | 479  |
| YUDELL L. LUKE  |      |
| 12. Struve Functions and Related Functions . . . . .          | 495  |
| MILTON ABRAMOWITZ   |      |
| 13. Confluent Hypergeometric Functions . . . . .              | 503  |
| LUCY JOAN SLATER  |      |
| 14. Coulomb Wave Functions . . . . .                          | 537  |
| MILTON ABRAMOWITZ   |      |
| 15. Hypergeometric Functions . . . . .                        | 555  |
| FRITZ OBERHETTINGER   |      |
| 16. Jacobian Elliptic Functions and Theta Functions . . . . . | 567  |
| L. M. MILNE-THOMSON   |      |
| 17. Elliptic Integrals . . . . .                              | 587  |
| L. M. MILNE-THOMSON   |      |
| 18. Weierstrass Elliptic and Related Functions . . . . .      | 627  |
| THOMAS H. SOUTHARD  |      |
| 19. Parabolic Cylinder Functions . . . . .                    | 685  |
| J. C. P. MILLER   |      |

|  | Page |
|--|------|
| 20. Mathieu Functions . . . . .                                      | 721  |
| GERTRUDE BLANCH  |      |
| 21. Spheroidal Wave Functions. . . . .                               | 751  |
| ARNOLD N. LOWAN  |      |
| 22. Orthogonal Polynomials . . . . .                                 | 771  |
| URS W. HOCHSTRASSER  |      |
| 23. Bernoulli and Euler Polynomials, Riemann Zeta Function . . . .   | 803  |
| EMILIE V. HAYNSWORTH and KARL GOLDBERG                               |      |
| 24. Combinatorial Analysis . . . . .                                 | 821  |
| K. GOLDBERG, M. NEWMAN and E. HAYNSWORTH                             |      |
| 25. Numerical Interpolation, Differentiation and Integration . . . . | 875  |
| PHILIP J. DAVIS and IVAN POLONSKY                                    |      |
| 26. Probability Functions . . . . .                                  | 925  |
| MARVIN ZELEN and NORMAN C. SEVERO                                    |      |
| 27. Miscellaneous Functions . . . . .                                | 997  |
| IRENE A. STEGUN  |      |
| 28. Scales of Notation. . . . .                                      | 1011 |
| S. PEAVY and A. SCHOPF   |      |
| 29. Laplace Transforms . . . . .                                     | 1019 |
| Subject Index . . . . .  | 1031 |
| Index of Notations . . . . .   | 1044 |



# Handbook of Mathematical Functions

with

## Formulas, Graphs, and Mathematical Tables

Edited by Milton Abramowitz and Irene A. Stegun

### 1. Introduction

The present Handbook has been designed to provide scientific investigators with a comprehensive and self-contained summary of the mathematical functions that arise in physical and engineering problems. The well-known Tables of Functions by E. Jahnke and F. Emde has been invaluable to workers in these fields in its many editions<sup>1</sup> during the past half-century. The present volume extends the work of these authors by giving more extensive and more accurate numerical tables, and by giving larger collections of mathematical properties of the tabulated functions. The number of functions covered has also been increased.

The classification of functions and organization of the chapters in this Handbook is similar to that of An Index of Mathematical Tables by A. Fletcher, J. C. P. Miller, and L. Rosenhead.<sup>2</sup> In general, the chapters contain numerical tables, graphs, polynomial or rational approximations for automatic computers, and statements of the principal mathematical properties of the tabulated functions, particularly those of computa-

tional importance. Many numerical examples are given to illustrate the use of the tables and also the computation of function values which lie outside their range. At the end of the text in each chapter there is a short bibliography giving books and papers in which proofs of the mathematical properties stated in the chapter may be found. Also listed in the bibliographies are the more important numerical tables. Comprehensive lists of tables are given in the Index mentioned above, and current information on new tables is to be found in the National Research Council quarterly Mathematics of Computation (formerly Mathematical Tables and Other Aids to Computation).

The mathematical notations used in this Handbook are those commonly adopted in standard texts, particularly Higher Transcendental Functions, Volumes 1-3, by A. Erdélyi, W. Magnus, F. Oberhettinger and F. G. Tricomi (McGraw-Hill, 1953-55). Some alternative notations have also been listed. The introduction of new symbols has been kept to a minimum, and an effort has been made to avoid the use of conflicting notation.

### 2. Accuracy of the Tables

The number of significant figures given in each table has depended to some extent on the number available in existing tabulations. There has been no attempt to make it uniform throughout the Handbook, which would have been a costly and laborious undertaking. In most tables at least five significant figures have been provided, and the tabular intervals have generally been chosen to ensure that linear interpolation will yield four- or five-figure accuracy, which suffices in most physical applications. Users requiring higher

precision in their interpolates may obtain them by use of higher-order interpolation procedures, described below.

In certain tables many-figured function values are given at irregular intervals in the argument. An example is provided by Table 9.4. The purpose of these tables is to furnish "key values" for the checking of programs for automatic computers; no question of interpolation arises.

The maximum end-figure error, or "tolerance" in the tables in this Handbook is  $\frac{1}{2}$  of 1 unit everywhere in the case of the elementary functions, and 1 unit in the case of the higher functions except in a few cases where it has been permitted to rise to 2 units.

<sup>1</sup> The most recent, the sixth, with F. Loesch added as co-author, was published in 1960 by McGraw-Hill, U.S.A., and Teubner, Germany.

<sup>2</sup> The second edition, with L. J. Comrie added as co-author, was published in two volumes in 1962 by Addison-Wesley, U.S.A., and Scientific Computing Service Ltd., Great Britain.

### 3. Auxiliary Functions and Arguments

One of the objects of this Handbook is to provide tables or computing methods which enable the user to evaluate the tabulated functions over complete ranges of real values of their parameters. In order to achieve this object, frequent use has been made of auxiliary functions to remove the infinite part of the original functions at their singularities, and auxiliary arguments to cope with infinite ranges. An example will make the procedure clear.

The exponential integral of positive argument is given by

$$\begin{aligned}
 \text{Ei}(x) &= \int_{-\infty}^x \frac{e^u}{u} du \\
 &= \gamma + \ln x + \frac{x}{1 \cdot 1!} + \frac{x^2}{2 \cdot 2!} + \frac{x^3}{3 \cdot 3!} + \dots \\
 &\sim \frac{e^x}{x} \left[ 1 + \frac{1!}{x} + \frac{2!}{x^2} + \frac{3!}{x^3} + \dots \right] (x \rightarrow \infty)
 \end{aligned}$$

The logarithmic singularity precludes direct interpolation near  $x=0$ . The functions  $\text{Ei}(x) - \ln x$  and  $x^{-1}[\text{Ei}(x) - \ln x - \gamma]$ , however, are well-behaved and readily interpolable in this region. Either will do as an auxiliary function; the latter was in fact selected as it yields slightly higher accuracy when  $\text{Ei}(x)$  is recovered. The function  $x^{-1}[\text{Ei}(x) - \ln x - \gamma]$  has been tabulated to nine decimals for the range  $0 \leq x \leq \frac{1}{2}$ . For  $\frac{1}{2} \leq x \leq 2$ ,  $\text{Ei}(x)$  is sufficiently well-behaved to admit direct tabulation, but for larger values of  $x$ , its exponential character predominates. A smoother and more readily interpolable function for large  $x$  is  $xe^{-x}\text{Ei}(x)$ ; this has been tabulated for  $2 \leq x \leq 10$ . Finally, the range  $10 \leq x \leq \infty$  is covered by use of the inverse argument  $x^{-1}$ . Twenty-one entries of  $xe^{-x}\text{Ei}(x)$ , corresponding to  $x^{-1} = .1(-.005)0$ , suffice to produce an interpolable table.

### 4. Interpolation

The tables in this Handbook are not provided with differences or other aids to interpolation, because it was felt that the space they require could be better employed by the tabulation of additional functions. Admittedly aids could have been given without consuming extra space by increasing the intervals of tabulation, but this would have conflicted with the requirement that linear interpolation is accurate to four or five figures.

For applications in which linear interpolation is insufficiently accurate it is intended that Lagrange's formula or Aitken's method of iterative linear interpolation<sup>3</sup> be used. To help the user, there is a statement at the foot of most tables of the maximum error in a linear interpolate, and the number of function values needed in Lagrange's formula or Aitken's method to interpolate to full tabular accuracy.

As an example, consider the following extract from Table 5.1.

| $x$ | $xe^x E_1(x)$ | $x$ | $xe^x E_1(x)$ |
|-----|---------------|-----|---------------|
| 7.5 | .89268 7854   | 8.0 | .89823 7113   |
| 7.6 | .89384 6312   | 8.1 | .89927 7888   |
| 7.7 | .89497 9666   | 8.2 | .90029 7306   |
| 7.8 | .89608 8737   | 8.3 | .90129 6073   |
| 7.9 | .89717 4302   | 8.4 | .90227 4695   |

$$\left[ \begin{array}{c} (-6)3 \\ 5 \end{array} \right]$$

The numbers in the square brackets mean that the maximum error in a linear interpolate is  $3 \times 10^{-6}$ , and that to interpolate to the full tabular accuracy five points must be used in Lagrange's and Aitken's methods.

<sup>3</sup> A. C. Aitken, On interpolation by iteration of proportional parts, without the use of differences, Proc. Edinburgh Math. Soc. 3, 56-76 (1932).

Let us suppose that we wish to compute the value of  $xe^x E_1(x)$  for  $x=7.9527$  from this table. We describe in turn the application of the methods of linear interpolation, Lagrange and Aitken, and of alternative methods based on differences and Taylor's series.

(1) Linear interpolation. The formula for this process is given by

$$f_p = (1-p)f_0 + pf_1$$

where  $f_0, f_1$  are consecutive tabular values of the function, corresponding to arguments  $x_0, x_1$ , respectively;  $p$  is the given fraction of the argument interval

$$p = (x - x_0) / (x_1 - x_0)$$

and  $f_p$  the required interpolate. In the present instance, we have

$$f_0 = .89717 4302 \quad f_1 = .89823 7113 \quad p = .527$$

The most convenient way to evaluate the formula on a desk calculating machine is to set  $f_0$  and  $f_1$  in turn on the keyboard, and carry out the multiplications by  $1-p$  and  $p$  cumulatively; a partial check is then provided by the multiplier dial reading unity. We obtain

$$\begin{aligned}
 f_{.527} &= (1-.527)(.89717 4302) + .527(.89823 7113) \\
 &= .89773 4403.
 \end{aligned}$$

Since it is known that there is a possible error of  $3 \times 10^{-6}$  in the linear formula, we round off this result to .89773. The maximum possible error in this answer is composed of the error committed



by the last rounding, that is,  $.4403 \times 10^{-5}$ , plus  $3 \times 10^{-6}$ , and so certainly cannot exceed  $.8 \times 10^{-5}$ .

(2) Lagrange's formula. In this example, the relevant formula is the 5-point one, given by

$$f = A_{-2}(p)f_{-2} + A_{-1}(p)f_{-1} + A_0(p)f_0 + A_1(p)f_1 + A_2(p)f_2$$

Tables of the coefficients  $A_k(p)$  are given in chapter 25 for the range  $p=0(.01)1$ . We evaluate the formula for  $p=.52, .53$  and  $.54$  in turn. Again, in each evaluation we accumulate the  $A_k(p)$  in the multiplier register since their sum is unity. We now have the following subtable.

| $x$   | $xe^xE_1(x)$ |       |    |
|-------|--------------|-------|----|
| 7.952 | .89772 9757  | 10622 |    |
| 7.953 | .89774 0379  | 10620 | -2 |
| 7.954 | .89775 0999  |       |    |

The numbers in the third and fourth columns are the first and second differences of the values of  $xe^xE_1(x)$  (see below); the smallness of the second difference provides a check on the three interpolations. The required value is now obtained by linear interpolation:

$$f_p = .3(.89772\ 9757) + .7(.89774\ 0379) = .89773\ 7192.$$

In cases where the correct order of the Lagrange polynomial is not known, one of the preliminary interpolations may have to be performed with polynomials of two or more different orders as a check on their adequacy.

(3) Aitken's method of iterative linear interpolation. The scheme for carrying out this process in the present example is as follows:

| $n$ | $x_n$ | $y_n = xe^xE_1(x)$ | $y_{0,n}$    | $y_{0,1,n}$  | $y_{0,1,2,n}$ | $y_{0,1,2,3,n}$ | $x_n - x$ |
|-----|-------|--------------------|--------------|--------------|---------------|-----------------|-----------|
| 0   | 8.0   | .89823 7113        |              |              |               |                 | .0473     |
| 1   | 7.9   | .89717 4302        | .89773 44034 |              |               |                 | -.0527    |
| 2   | 8.1   | .89927 7888        | .89774 48264 | .89773 71499 |               |                 | .1473     |
| 3   | 7.8   | .89608 8737        | 2 90220      | 2394         | .89773 71938  |                 | -.1527    |
| 4   | 8.2   | .90029 7306        | 4 98773      | 1216         | 16            | .89773 71930    | .2473     |
| 5   | 7.7   | .89497 9666        | 2 35221      | 2706         | 43            | 30              | -.2527    |

Here

$$y_{0,n} = \frac{1}{x_n - x_0} \begin{vmatrix} y_0 & x_0 - x \\ y_n & x_n - x \end{vmatrix}$$

$$y_{0,1,n} = \frac{1}{x_n - x_1} \begin{vmatrix} y_{0,1} & x_1 - x \\ y_{0,n} & x_n - x \end{vmatrix}$$

$$y_{0,1,\dots,m-1,n} = \frac{1}{x_n - x_m} \begin{vmatrix} y_{0,1,\dots,m-1} & x_{m-1} - x \\ y_{0,1,\dots,m-1,n} & x_n - x \end{vmatrix}$$

If the quantities  $x_n - x$  and  $x_m - x$  are used as multipliers when forming the cross-product on a desk machine, their accumulation  $(x_n - x) - (x_m - x)$  in the multiplier register is the divisor to be used at that stage. An extra decimal place is usually carried in the intermediate interpolates to safeguard against accumulation of rounding errors.

The order in which the tabular values are used is immaterial to some extent, but to achieve the maximum rate of convergence and at the same time minimize accumulation of rounding errors, we begin, as in this example, with the tabular argument nearest to the given argument, then take the nearest of the remaining tabular arguments, and so on.

The number of tabular values required to achieve a given precision emerges naturally in the course of the iterations. Thus in the present example six values were used, even though it was known in advance that five would suffice. The extra row confirms the convergence and provides a valuable check.

(4) Difference formulas. We use the central difference notation (chapter 25),

|       |       |                  |                |                    |                |
|-------|-------|------------------|----------------|--------------------|----------------|
| $x_0$ | $f_0$ |                  |                |                    |                |
|       |       | $\delta f_{1/2}$ |                |                    |                |
| $x_1$ | $f_1$ |                  | $\delta^2 f_1$ |                    |                |
|       |       | $\delta f_{3/2}$ |                | $\delta^3 f_{3/2}$ |                |
| $x_2$ | $f_2$ |                  | $\delta^2 f_2$ |                    | $\delta^4 f_2$ |
|       |       | $\delta f_{5/2}$ |                | $\delta^3 f_{5/2}$ |                |
| $x_3$ | $f_3$ |                  | $\delta^2 f_3$ |                    |                |
|       |       | $\delta f_{7/2}$ |                |                    |                |
| $x_4$ | $f_4$ |                  |                |                    |                |

Here

$$\begin{aligned} \delta f_{1/2} &= f_1 - f_0, \delta f_{3/2} = f_2 - f_1, \dots, \\ \delta^2 f_1 &= \delta f_{3/2} - \delta f_{1/2} = f_2 - 2f_1 + f_0 \\ \delta^3 f_{3/2} &= \delta^2 f_2 - \delta^2 f_1 = f_3 - 3f_2 + 3f_1 - f_0 \\ \delta^4 f_2 &= \delta^3 f_{5/2} - \delta^3 f_{3/2} = f_4 - 4f_3 + 6f_2 - 4f_1 + f_0 \end{aligned}$$

and so on.

In the present example the relevant part of the difference table is as follows, the differences being written in units of the last decimal place of the function, as is customary. The smallness of the high differences provides a check on the function values

| $x$ | $xe^xE_1(x)$ | $\delta^2 f$ | $\delta^4 f$ |
|-----|--------------|--------------|--------------|
| 7.9 | .89717 4302  | -2 2754      | -34          |
| 8.0 | .89823 7113  | -2 2036      | -39          |

Applying, for example, Everett's interpolation formula

$$f_p = (1-p)f_0 + E_2(p)\delta^2 f_0 + E_4(p)\delta^4 f_0 + \dots + pf_1 + F_2(p)\delta^2 f_1 + F_4(p)\delta^4 f_1 + \dots$$

and taking the numerical values of the interpolation coefficients  $E_2(p)$ ,  $E_4(p)$ ,  $F_2(p)$  and  $F_4(p)$  from Table 25.1, we find that

$$10^9 f_{.527} = .473(89717\ 4302) + .061196(2\ 2754) - .012(34) \\ + .527(89823\ 7113) + .063439(2\ 2036) - .012(39) \\ = 89773\ 7193.$$

We may notice in passing that Everett's formula shows that the error in a linear interpolate is approximately

$$E_2(p)\delta^2 f_0 + F_2(p)\delta^2 f_1 \approx \frac{1}{2}[E_2(p) + F_2(p)][\delta^2 f_0 + \delta^2 f_1]$$

Since the maximum value of  $|E_2(p) + F_2(p)|$  in the range  $0 < p < 1$  is  $\frac{1}{8}$ , the maximum error in a linear interpolate is approximately

$$\frac{1}{16} |\delta^2 f_0 + \delta^2 f_1|, \text{ that is, } \frac{1}{16} |f_2 - f_1 - f_0 + f_{-1}|.$$

(5) Taylor's series. In cases where the successive derivatives of the tabulated function can be computed fairly easily, Taylor's expansion

$$f(x) = f(x_0) + (x - x_0) \frac{f'(x_0)}{1!} + (x - x_0)^2 \frac{f''(x_0)}{2!} \\ + (x - x_0)^3 \frac{f'''(x_0)}{3!} + \dots$$

### 5. Inverse Interpolation

With linear interpolation there is no difference in principle between direct and inverse interpolation. In cases where the linear formula provides an insufficiently accurate answer, two methods are available. We may interpolate directly, for example, by Lagrange's formula to prepare a new table at a fine interval in the neighborhood of the approximate value, and then apply accurate inverse linear interpolation to the subtabulated values. Alternatively, we may use Aitken's method or even possibly the Taylor's series method, with the roles of function and argument interchanged.

It is important to realize that the accuracy of an inverse interpolate may be very different from that of a direct interpolate. This is particularly true in regions where the function is slowly varying, for example, near a maximum or minimum. The maximum precision attainable in an inverse interpolate can be estimated with the aid of the formula

$$\Delta x \approx \Delta f \frac{df}{dx}$$

in which  $\Delta f$  is the maximum possible error in the function values.

Example. Given  $xe^x E_1(x) = .9$ , find  $x$  from the table on page X.

(i) Inverse linear interpolation. The formula for  $p$  is

$$p = (f_p - f_0) / (f_1 - f_0).$$

In the present example, we have

$$p = \frac{.9 - .89927\ 7888}{.90029\ 7306 - .89927\ 7888} = \frac{72\ 2112}{101\ 9418} = .708357.$$

can be used. We first compute as many of the derivatives  $f^{(n)}(x_0)$  as are significant, and then evaluate the series for the given value of  $x$ . An advisable check on the computed values of the derivatives is to reproduce the adjacent tabular values by evaluating the series for  $x = x_{-1}$  and  $x_1$ .

In the present example, we have

$$f(x) = xe^x E_1(x) \\ f'(x) = (1 + x^{-1})f(x) - 1 \\ f''(x) = (1 + x^{-1})f'(x) - x^{-2}f(x) \\ f'''(x) = (1 + x^{-1})f''(x) - 2x^{-2}f'(x) + 2x^{-3}f(x).$$

With  $x_0 = 7.9$  and  $x - x_0 = .0527$  our computations are as follows; an extra decimal has been retained in the values of the terms in the series to safeguard against accumulation of rounding errors.

| $k$ | $f^{(k)}(x_0)/k!$ | $(x - x_0)^k f^{(k)}(x_0)/k!$ |
|-----|-------------------|-------------------------------|
| 0   | .89717 4302       | .89717 4302                   |
| 1   | .01074 0669       | .00056 6033 3                 |
| 2   | -.00113 7621      | -.00000 3159 5                |
| 3   | .00012 1987       | .00000 0017 9                 |
|     |                   | .89773 7194                   |

The desired  $x$  is therefore

$$x = x_0 + p(x_1 - x_0) = 8.1 + .708357(.1) = 8.17083\ 57$$

To estimate the possible error in this answer, we recall that the maximum error of direct linear interpolation in this table is  $\Delta f = 3 \times 10^{-6}$ . An approximate value for  $df/dx$  is the ratio of the first difference to the argument interval (chapter 25), in this case .010. Hence the maximum error in  $x$  is approximately  $3 \times 10^{-6} / (.010)$ , that is, .0003.

(ii) Subtabulation method. To improve the approximate value of  $x$  just obtained, we interpolate directly for  $p = .70, .71$  and  $.72$  with the aid of Lagrange's 5-point formula,

| $x$   | $xe^x E_1(x)$ | $\delta$ | $\delta^2$ |
|-------|---------------|----------|------------|
| 8.170 | .89999 3683   |          |            |
| 8.171 | .90000 3834   | 1 0151   |            |
| 8.172 | .90001 3983   | 1 0149   | -2         |

Inverse linear interpolation in the new table gives

$$p = \frac{.9 - .89999\ 3683}{.00001\ 0151} = .6223$$

Hence  $x = 8.17062\ 23$ .

An estimate of the maximum error in this result is

$$\Delta f \frac{df}{dx} \approx \frac{1 \times 10^{-9}}{.010} = 1 \times 10^{-7}$$

(iii) Aitken's method. This is carried out in the same manner as in direct interpolation.

| $n$ | $y_n = xe^x E_1(x)$ | $x_n$ | $x_{0,n}$    | $x_{0,1,n}$  | $x_{0,1,2,n}$ | $x_{0,1,2,3,n}$ | $y_n - y$    |
|-----|---------------------|-------|--------------|--------------|---------------|-----------------|--------------|
| 0   | .90029 7306         | 8.2   |              |              |               |                 | .00029 7306  |
| 1   | .89927 7888         | 8.1   | 8.17083 5712 |              |               |                 | -.00072 2112 |
| 2   | .90129 6033         | 8.3   | 8.17023 1505 | 8.17061 9521 |               |                 | -.00129 6033 |
| 3   | .89823 7113         | 8.0   | 8.17113 8043 | 2 5948       | 8.17062 2244  |                 | -.00176 2887 |
| 4   | .90227 4695         | 8.4   | 8.16992 9437 | 1 7335       | 415           | 8.17062 2318    | .00227 4695  |
| 5   | .89717 4302         | 7.9   | 8.17144 0382 | 2 8142       | 231           | 265             | -.00282 5698 |

The estimate of the maximum error in this result is the same as in the subtabulation method. An indication of the error is also provided by the

discrepancy in the highest interpolates, in this case  $x_{0,1,2,3,4}$ , and  $x_{0,1,2,3,5}$ .

### 6. Bivariate Interpolation

Bivariate interpolation is generally most simply performed as a sequence of univariate interpolations. We carry out the interpolation in one direction, by one of the methods already described, for several tabular values of the second argument in the neighborhood of its given value. The interpolates are differenced as a check, and

interpolation is then carried out in the second direction.

An alternative procedure in the case of functions of a complex variable is to use the Taylor's series expansion, provided that successive derivatives of the function can be computed without much difficulty.

### 7. Generation of Functions from Recurrence Relations

Many of the special mathematical functions which depend on a parameter, called their index, order or degree, satisfy a linear difference equation (or recurrence relation) with respect to this parameter. Examples are furnished by the Legendre function  $P_n(x)$ , the Bessel function  $J_n(x)$  and the exponential integral  $E_n(x)$ , for which we have the respective recurrence relations

$$(n+1)P_{n+1} - (2n+1)xP_n + nP_{n-1} = 0$$

$$J_{n+1} - \frac{2n}{x}J_n + J_{n-1} = 0$$

$$nE_{n+1} + xE_n = e^{-x}$$

Particularly for automatic work, recurrence relations provide an important and powerful computing tool. If the values of  $P_n(x)$  or  $J_n(x)$  are known for two consecutive values of  $n$ , or  $E_n(x)$  is known for one value of  $n$ , then the function may be computed for other values of  $n$  by successive applications of the relation. Since generation is carried out perforce with rounded values, it is vital to know how errors may be propagated in the recurrence process. If the errors do not grow relative to the size of the wanted function, the process is said to be stable. If, however, the relative errors grow and will eventually overwhelm the wanted function, the process is unstable.

It is important to realize that stability may depend on (i) the particular solution of the difference equation being computed; (ii) the values of  $x$  or other parameters in the difference equation;

(iii) the direction in which the recurrence is being applied. Examples are as follows.

Stability—increasing  $n$

$$P_n(x), P_n''(x)$$

$$Q_n(x), Q_n''(x) \quad (x < 1)$$

$$Y_n(x), K_n(x)$$

$$J_{-n-\frac{1}{2}}(x), I_{-n-\frac{1}{2}}(x)$$

$$E_n(x) \quad (n < x)$$

Stability—decreasing  $n$

$$P_n(x), P_n''(x) \quad (x < 1)$$

$$Q_n(x), Q_n''(x)$$

$$J_n(x), I_n(x)$$

$$J_{n+\frac{1}{2}}(x), I_{n+\frac{1}{2}}(x)$$

$$E_n(x) \quad (n > x)$$

$$F_n(\eta, \rho) \quad (\text{Coulomb wave function})$$

Illustrations of the generation of functions from their recurrence relations are given in the pertinent chapters. It is also shown that even in cases where the recurrence process is unstable, it may still be used when the starting values are known to sufficient accuracy.

Mention must also be made here of a refinement, due to J. C. P. Miller, which enables a recurrence process which is stable for decreasing  $n$  to be applied without any knowledge of starting values for large  $n$ . Miller's algorithm, which is well-suited to automatic work, is described in 19.28, **Example 1**.

### 8. Acknowledgments

The production of this volume has been the result of the unrelenting efforts of many persons, all of whose contributions have been instrumental in accomplishing the task. The Editor expresses his thanks to each and every one.

The Ad Hoc Advisory Committee individually and together were instrumental in establishing the basic tenets that served as a guide in the formation of the entire work. In particular, special thanks are due to Professor Philip M. Morse for his continuous encouragement and support. Professors J. Todd and A. Erdélyi, panel members of the Conferences on Tables and members of the Advisory Committee have maintained an undiminished interest, offered many suggestions and carefully read all the chapters.

Irene A. Stegun has served effectively as associate editor, sharing in each stage of the planning of the volume. Without her untiring efforts, completion would never have been possible.

Appreciation is expressed for the generous cooperation of publishers and authors in granting permission for the use of their source material. Acknowledgments for tabular material taken wholly or in part from published works are given on the first page of each table. Myrtle R. Kellington corresponded with authors and publishers to obtain formal permission for including their material, maintained uniformity throughout the

bibliographic references and assisted in preparing the introductory material.

Valuable assistance in the preparation, checking and editing of the tabular material was received from Ruth E. Capuano, Elizabeth F. Godefroy, David S. Liepman, Kermit Nelson, Bertha H. Walter and Ruth Zucker.

Equally important has been the untiring cooperation, assistance, and patience of the members of the NBS staff in handling the myriad of detail necessarily attending the publication of a volume of this magnitude. Especially appreciated have been the helpful discussions and services from the members of the Office of Technical Information in the areas of editorial format, graphic art layout, printing detail, preprinting reproduction needs, as well as attention to promotional detail and financial support. In addition, the clerical and typing staff of the Applied Mathematics Division merit commendation for their efficient and patient production of manuscript copy involving complicated technical notation.

Finally, the continued support of Dr. E. W. Cannon, chief of the Applied Mathematics Division, and the advice of Dr. F. L. Alt, assistant chief, as well as of the many mathematicians in the Division, is gratefully acknowledged.

M. ABRAMOWITZ.

## 2. Physical Constants and Conversion Factors

A. G. McNISH<sup>1</sup>

### Contents

|   | Page |
|---|------|
| <b>Table 2.1.</b> Common Units and Conversion Factors . . . . .                             | 6    |
| <b>Table 2.2.</b> Names and Conversion Factors for Electric and Magnetic<br>Units . . . . . | 6    |
| <b>Table 2.3.</b> Adjusted Values of Constants . . . . .                                    | 7    |
| <b>Table 2.4.</b> Miscellaneous Conversion Factors. . . . .                                 | 8    |
| <b>Table 2.5.</b> Conversion Factors for Customary U.S. Units to Metric<br>Units . . . . .  | 8    |
| <b>Table 2.6.</b> Geodetic Constants . . . . .  | 8    |

---

<sup>1</sup> National Bureau of Standards.



## 2. Physical Constants and Conversion Factors

The tables in this chapter supply some of the more commonly needed physical constants and conversion factors.\*

The International System of Units (SI) established in 1960 by the General Conference of Weights and Measures under the Treaty of the Meter is based upon: the meter (m) for length, defined as 1 650 763.73 wave-lengths in vacuum corresponding to the transition  $2p_{10}-5d_5$  of krypton 86; the kilogram (kg) for mass, defined as the mass of the prototype kilogram at Sevres, France; the second (s) for time, defined as the duration of 9 192 631 770 periods of the radiation corresponding to the transition between the two hyperfine levels of cesium 133; the kelvin (K) for temperature, defined as 1/273.16 of the thermodynamic temperature of the triple point of water; the ampere (A) for electric current, defined as the current which, if flowing in two infinitely long parallel wires *in vacuo* separated by one meter, would produce a force of  $2 \times 10^{-7}$  newtons per meter of length between the wires; and the candela (cd) for luminous intensity, defined as the luminous intensity of 1/600 000 square meter of a perfect radiator at the temperature of freezing platinum.

All other units of SI are derived from these base units by assigning the value unity to the proportionality constants in the defining equations (official symbols for other SI units appear in Tables 2.1 and 2.2). Taking 1/100 of the

meter as the unit for length and 1/1000 of the kilogram as the unit for mass gives rise similarly to the cgs system, often used in physics and chemistry.

SI, as it is ordinarily used in electromagnetism, is a rationalized system, i.e., the electromagnetic units of SI relate to the quantities appearing in the so-called rationalized electromagnetic equations. Thus, the force per unit length between two current-carrying parallel wires of infinite length separated by unit distance *in vacuo* is  $2f = \mu_0 i_1 i_2 / 4\pi$ , where  $\mu_0$  has the value  $4\pi \times 10^{-7}$  H/m. The force between two electric charges *in vacuo* is correspondingly given by  $f = q_1 q_2 / 4\pi \epsilon_0 r^2$ ,  $\epsilon_0$  having the value  $1/\mu_0 c^2$ , where  $c$  is the speed of light in meters per second. ( $\epsilon_0 \sim 8.854 \times 10^{-12}$  F/m)

Setting  $\mu_0$  equal to unity and deleting  $4\pi$  from the denominator in the first equation above defines the cgs-emu system. Setting  $\epsilon_0$  equal to unity and deleting  $4\pi$  from the denominator in the second equation correspondingly defines the cgs-esu system. The cgs-emu and the cgs-esu systems are most frequently used in the unrationalized forms.

**Table 2.1. Common Units and Conversion Factors, CGS System and SI**

| Quantity | SI Name    | CGS Name | Factor |
|----------|------------|----------|--------|
| Force    | newton (N) | dyne     | $10^5$ |
| Energy   | joule (J)  | erg      | $10^7$ |
| Power    | watt (W)   | .....    | $10^7$ |

\*See also "Preface to Ninth Printing," page IIIa and page II.

**Table 2.2. Names and Conversion Factors for Electric and Magnetic Units**

| Quantity              | SI name          | emu name   | esu name    | emu-SI factors        | esu-SI factors               |
|-----------------------|------------------|------------|-------------|-----------------------|------------------------------|
| Current               | ampere (A)       | abampere   | statampere  | $10^{-1}$             | $\sim 3 \times 10^9$         |
| Charge                | coulomb (C)      | abcoulomb  | statcoulomb | $10^{-1}$             | $\sim 3 \times 10^9$         |
| Potential             | volt (V)         | abvolt     | statvolt    | $10^8$                | $\sim (1/3) \times 10^{-2}$  |
| Resistance            | ohm ( $\Omega$ ) | abohm      | statohm     | $10^9$                | $\sim (1/9) \times 10^{-11}$ |
| Inductance            | henry (H)        | centimeter | .....       | $10^9$                | $\sim (1/9) \times 10^{-11}$ |
| Capacitance           | farad (F)        | .....      | centimeter  | $10^{-9}$             | $\sim 9 \times 10^{11}$      |
| Magnetizing force     | $A \cdot m^{-1}$ | oersted    | .....       | $4\pi \times 10^{-3}$ | $\sim 3 \times 10^9$         |
| Magnetomotive force   | A                | gilbert    | .....       | $4\pi \times 10^{-1}$ | $\sim 3/10^6$                |
| Magnetic flux         | weber (Wb)       | maxwell    | .....       | $10^8$                | $\sim (1/3) \times 10^{-2}$  |
| Magnetic flux density | tesla (T)        | gauss (G)  | .....       | $10^4$                | $\sim (1/3) \times 10^{-6}$  |
| Electric displacement | .....            | .....      | .....       | $10^{-5}$             | $\sim 3 \times 10^5$         |

Example: If the value assigned to a current is 100 amperes its value in abamperes is  $100 \times 10^{-1} = 10$ .

The values of constants given in Table 2.3 are based on an adjustment by Taylor, Parker, and Langenberg, Rev. Mod. Phys. 41, p.375 (1969). They are being considered for adoption by the Task Group on Fundamental Constants of the Committee on Data for Science and Technology, International Council of Scientific Unions. The uncertainties given are standard errors estimated from the experimental data included in the adjustment. Where applicable, values are based on the unified scale of atomic masses in which the atomic mass unit (u) is defined as 1/12 of the mass of the atom of the <sup>12</sup>C nuclide.

Table 2.3. Adjusted Values of Constants

| Constant   | Symbol                              | Value                              | Uncertainty † | Unit  |   |
|--|-------------------------------------|------------------------------------|---------------|---|---|
|  |                                     |                                    |               | Systeme International (SI)                            | Centimeter-gram-second (CGS)  |
| Speed of light in vacuum                         | <i>c</i>                            | 2.997 925 0                        | ±10           | ×10 <sup>8</sup> m/s                                  | ×10 <sup>10</sup> cm/s  |
| Elementary charge                                | <i>e</i>                            | 1.602 191 7                        | 70            | 10 <sup>-19</sup> C                                   | 10 <sup>-20</sup> cm <sup>1/2</sup> g <sup>1/2</sup> *                                  |
|  |                                     | 4.803 250                          | 21            | -----   | 10 <sup>-10</sup> cm <sup>3/2</sup> g <sup>1/2</sup> s <sup>-1</sup> †                  |
| Avogadro constant                                | <i>N<sub>A</sub></i>                | 6.022 169                          | 40            | 10 <sup>23</sup> mol <sup>-1</sup>                    | 10 <sup>23</sup> mol <sup>-1</sup>  |
| Atomic mass unit                                 | <i>u</i>                            | 1.660 531                          | 11            | 10 <sup>-27</sup> kg                                  | 10 <sup>-24</sup> g   |
| Electron rest mass                               | <i>m<sub>e</sub></i>                | 9.109 558                          | 54            | 10 <sup>-31</sup> kg                                  | 10 <sup>-28</sup> g   |
|  |                                     | 5.485 930                          | 34            | 10 <sup>-4</sup> u                                    | 10 <sup>-4</sup> u  |
| Proton rest mass                                 | <i>m<sub>p</sub></i>                | 1.672 614                          | 11            | 10 <sup>-27</sup> kg                                  | 10 <sup>-24</sup> g   |
|  |                                     | 1.007 276 61                       | 8             | 10 <sup>0</sup> u                                     | 10 <sup>0</sup> u   |
| Neutron rest mass                                | <i>m<sub>n</sub></i>                | 1.674 920                          | 11            | 10 <sup>-27</sup> kg                                  | 10 <sup>-24</sup> g   |
|  |                                     | 1.008 665 20                       | 10            | 10 <sup>0</sup> u                                     | 10 <sup>0</sup> u   |
| Faraday constant                                 | <i>F</i>                            | 9.648 670                          | 54            | 10 <sup>4</sup> C/mol                                 | 10 <sup>3</sup> cm <sup>1/2</sup> g <sup>1/2</sup> mol <sup>-1</sup> *                  |
|  |                                     | 2.892 599                          | 16            | -----   | 10 <sup>14</sup> cm <sup>3/2</sup> g <sup>1/2</sup> s <sup>-1</sup> mol <sup>-1</sup> † |
| Planck constant                                  | <i>h</i>                            | 6.626 196                          | 50            | 10 <sup>-34</sup> J · s                               | 10 <sup>-27</sup> erg · s   |
|  |                                     | 1.054 591 9                        | 80            | 10 <sup>-34</sup> J · s                               | 10 <sup>-27</sup> erg · s   |
| Fine structure constant                          | <i>α</i>                            | 7.297 351                          | 11            | 10 <sup>-3</sup> -----                                | 10 <sup>-3</sup> -----  |
|  |                                     | 1/α                                | 1.370 360 2   | 21  | 10 <sup>2</sup> -----   |
| Charge to mass ratio for electron                | <i>e/m<sub>e</sub></i>              | 1.758 802 8                        | 54            | 10 <sup>11</sup> C/kg                                 | 10 <sup>7</sup> cm <sup>1/2</sup> /g <sup>1/2</sup> *                                   |
|  |                                     | 5.272 759                          | 16            | -----   | 10 <sup>17</sup> cm <sup>3/2</sup> g <sup>-1/2</sup> s <sup>-1</sup> †                  |
| Quantum-charge ratio                             | <i>h/e</i>                          | 4.135 708                          | 14            | 10 <sup>-15</sup> J · s/C                             | 10 <sup>-7</sup> cm <sup>3/2</sup> g <sup>1/2</sup> s <sup>-1</sup> *                   |
|  |                                     | 1.379 523 4                        | 46            | -----   | 10 <sup>-17</sup> cm <sup>1/2</sup> g <sup>1/2</sup> †                                  |
| Compton wavelength of electron                   | <i>λ<sub>C</sub></i>                | 2.426 309 6                        | 74            | 10 <sup>-12</sup> m                                   | 10 <sup>-10</sup> cm  |
|  |                                     | <i>λ<sub>C</sub>/2π</i>            | 3.861 592     | 12  | 10 <sup>-13</sup> m   |
| Compton wavelength of proton                     | <i>λ<sub>C,p</sub></i>              | 1.321 440 9                        | 90            | 10 <sup>-15</sup> m                                   | 10 <sup>-13</sup> cm  |
|  |                                     | <i>λ<sub>C,p</sub>/2π</i>          | 2.103 139     | 14  | 10 <sup>-16</sup> m   |
| Rydberg constant                                 | <i>R<sub>∞</sub></i>                | 1.097 373 12                       | 11            | 10 <sup>7</sup> m <sup>-1</sup>                       | 10 <sup>5</sup> cm <sup>-1</sup>  |
| Bohr radius                                      | <i>a<sub>0</sub></i>                | 5.291 771 5                        | 81            | 10 <sup>-11</sup> m                                   | 10 <sup>-9</sup> cm   |
| Electron radius                                  | <i>r<sub>e</sub></i>                | 2.817 939                          | 13            | 10 <sup>-15</sup> m                                   | 10 <sup>-13</sup> cm  |
| Gyromagnetic ratio of proton                     | <i>γ</i>                            | 2.675 196 5                        | 82            | 10 <sup>8</sup> rad · s <sup>-1</sup> T <sup>-1</sup> | 10 <sup>4</sup> rad · s <sup>-1</sup> G <sup>-1</sup> *                                 |
|  |                                     | <i>γ/2π</i>                        | 4.257 707     | 13  | 10 <sup>7</sup> Hz/T  |
| (uncorrected for diamagnetism, H <sub>2</sub> O) | <i>γ'</i>                           | 2.675 127 0                        | 82            | 10 <sup>8</sup> rad · s <sup>-1</sup> T <sup>-1</sup> | 10 <sup>4</sup> rad · s <sup>-1</sup> G <sup>-1</sup> *                                 |
|  |                                     | <i>γ'/2π</i>                       | 4.257 597     | 13  | 10 <sup>7</sup> Hz/T  |
| Bohr magneton                                    | <i>μ<sub>B</sub></i>                | 9.274 096                          | 65            | 10 <sup>-24</sup> J/T                                 | 10 <sup>-21</sup> erg/G *   |
| Nuclear magneton                                 | <i>μ<sub>N</sub></i>                | 5.050 951                          | 50            | 10 <sup>-27</sup> J/T                                 | 10 <sup>-24</sup> erg/G *   |
| Proton moment                                    | <i>μ<sub>p</sub></i>                | 1.410 620 3                        | 99            | 10 <sup>-26</sup> J/T                                 | 10 <sup>-23</sup> erg/G *   |
|  |                                     | <i>μ<sub>p</sub>/μ<sub>N</sub></i> | 2.792 782     | 17  | 10 <sup>0</sup> -----   |
| (uncorrected for diamagnetism, H <sub>2</sub> O) | <i>μ'<sub>p</sub>/μ<sub>N</sub></i> | 2.792 709                          | 17            | 10 <sup>0</sup> -----                                 | 10 <sup>0</sup> -----   |
| Gas constant                                     | <i>R</i>                            | 8.314 34                           | 35            | 10 <sup>0</sup> J · K <sup>-1</sup> mol <sup>-1</sup> | 10 <sup>7</sup> erg · K <sup>-1</sup> mol <sup>-1</sup>                                 |
| Normal volume perfect gas                        | <i>V<sub>0</sub></i>                | 2.241 36                           | 39            | 10 <sup>-2</sup> m <sup>3</sup> /mol                  | 10 <sup>4</sup> cm <sup>3</sup> /mol  |
| Boltzmann constant                               | <i>k</i>                            | 1.380 622                          | 59            | 10 <sup>-23</sup> J/K                                 | 10 <sup>-16</sup> erg/K   |
| First radiation constant (8πhc)                  | <i>c<sub>1</sub></i>                | 4.992 579                          | 38            | 10 <sup>-24</sup> J · m                               | 10 <sup>-15</sup> erg · cm  |
| Second radiation constant                        | <i>c<sub>2</sub></i>                | 1.438 833                          | 61            | 10 <sup>-2</sup> m · K                                | 10 <sup>0</sup> cm · K  |
| Stefan-Boltzmann constant                        | <i>σ</i>                            | 5.669 61                           | 96            | 10 <sup>-8</sup> W · m <sup>-2</sup> K <sup>-4</sup>  | 10 <sup>-5</sup> erg · cm <sup>-2</sup> s <sup>-1</sup> K <sup>-4</sup>                 |
| Gravitational constant                           | <i>G</i>                            | 6.673 2                            | 31            | 10 <sup>-11</sup> N · m <sup>2</sup> /kg <sup>2</sup> | 10 <sup>-8</sup> dyn · cm <sup>2</sup> /g <sup>2</sup>                                  |

‡Based on 1 std. dev; applies to last digits in preceding column.

\*Electromagnetic system.

†Electrostatic system.

**Table 2.4. Miscellaneous Conversion Factors**

|   |  |
|---|--|
| Standard gravity, $g_0$   | = 9.806 65 meters per second per second*               |
| Standard atmospheric pressure, $P_0$  | = $1.013\ 25 \times 10^5$ newtons per square meter*    |
|   | = $1.013\ 25 \times 10^6$ dynes per square centimeter* |
| 1 thermodynamic calorie, <sup>1</sup> cal <sub>c</sub>  | = 4.1840 joules*                                       |
| 1 IT calorie <sup>2</sup> , cal <sub>s</sub>  | = 4.1868 joules*                                       |
| 1 liter, l  | = $10^{-3}$ cubic meter*                               |
| 1 angstrom unit, Å  | = $10^{-10}$ meter*                                    |
| 1 bar   | = $10^5$ newtons per square meter*                     |
|   | = $10^6$ dynes per square centimeter*                  |
| 1 gal   | = $10^{-2}$ meter per second per second*               |
|   | = 1 centimeter per second per second*                  |
| 1 astronomical unit, AU   | = $1.496 \times 10^{11}$ meters                        |
| 1 light year  | = $9.46 \times 10^{15}$ meters                         |
| 1 parsec  | = $3.08 \times 10^{16}$ meters                         |
|   | = 3.26 light years                                     |
| 1 curie, the quantity of radioactive material undergoing $3.7 \times 10^{10}$ disintegrations per second*.  |  |
| 1 roentgen, the exposure of x- or gamma radiation which produces together with its secondaries $2.082 \times 10^9$ electron-ion pairs in 0.001 293 gram of air. |  |

The index of refraction of the atmosphere for radio waves of frequency less than  $3 \times 10^{10}$  Hz is given by  $(n - 1)10^6 = (77.6/t)(p + 4810e/t)$ , where  $n$  is the refractive index;  $t$ , temperature in kelvins;  $p$ , total pressure in millibars;  $e$ , water vapor partial pressure in millibars.

Factors for converting the customary United States units to units of the metric system are given in Table 2.5.

**Table 2.5. Factors for Converting Customary U.S. Units to SI Units**

|                                     |                                   |
|-------------------------------------|-----------------------------------|
| 1 yard                              | 0.914 4 meter*                    |
| 1 foot                              | 0.304 8 meter*                    |
| 1 inch                              | 0.025 4 meter*                    |
| 1 statute mile                      | 1 609.344 meters*                 |
| 1 nautical mile (international)     | 1 852 meters*                     |
| 1 pound (avdp.)                     | 0.453 592 37 kilogram*            |
| 1 oz. (avdp.)                       | 0.028 349 52 kilogram             |
| 1 pound force                       | 4.448 22 newtons                  |
| 1 slug                              | 14.593 9 kilograms                |
| 1 poundal                           | 0.138 255 newtons                 |
| 1 foot pound                        | 1.355 82 joules                   |
| Temperature (Fahrenheit)            | $32 + (9/5)$ Celsius temperature* |
| 1 British thermal unit <sup>3</sup> | 1055 joules                       |

Geodetic constants for the international (Hayford) spheroid are given in Table 2.6. The gravity values are on the basis of the revised Potsdam value. They are about 14 parts per million smaller than previous values. They are calculated for the surface of the geoid by the international formula.

**Table 2.6. Geodetic Constants**

$a = 6\ 378\ 388$  m;  $f = 1/297$ ;  $b = 6\ 356\ 912$  m

| Latitude | Length of 1' of longitude | Length of 1' of latitude | $g$                    |
|----------|---------------------------|--------------------------|------------------------|
|          | <i>Meters</i>             | <i>Meters</i>            | <i>m/s<sup>2</sup></i> |
| 0°       | 1 855.398                 | 1 842.925                | 9.780 350              |
| 15       | 1 792.580                 | 1 844.170                | 9.783 800              |
| 30       | 1 608.174                 | 1 847.580                | 9.793 238              |
| 45       | 1 314.175                 | 1 852.256                | 9.806 154              |
| 60       | 930.047                   | 1 856.951                | 9.819 099              |
| 75       | 481.725                   | 1 860.401                | 9.828 593              |
| 90       | 0                         | 1 861.666                | 9.832 072              |

<sup>1</sup> Used principally by chemists.

<sup>2</sup> Used principally by engineers.

<sup>3</sup> Various definitions are given for the British thermal unit. This represents a rounded mean value differing from none of the more important definitions by more than 3 in  $10^4$ .

\* Exact value.



# 3. Elementary Analytical Methods

MILTON ABRAMOWITZ <sup>1</sup>

## Contents

|   | Page |
|---|------|
| <b>Elementary Analytical Methods</b> . . . . .  | 10   |
| 3.1. Binomial Theorem and Binomial Coefficients; Arithmetic and Geometric Progressions; Arithmetic, Geometric, Harmonic and Generalized Means . . . . . | 10   |
| 3.2. Inequalities . . . . .   | 10   |
| 3.3. Rules for Differentiation and Integration . . . . .  | 11   |
| 3.4. Limits, Maxima and Minima . . . . .  | 13   |
| 3.5. Absolute and Relative Errors . . . . .   | 14   |
| 3.6. Infinite Series . . . . .  | 14   |
| 3.7. Complex Numbers and Functions . . . . .  | 16   |
| 3.8. Algebraic Equations . . . . .  | 17   |
| 3.9. Successive Approximation Methods . . . . .   | 18   |
| 3.10. Theorems on Continued Fractions . . . . .   | 19   |
| <b>Numerical Methods</b> . . . . .  | 19   |
| 3.11. Use and Extension of the Tables . . . . .   | 19   |
| 3.12. Computing Techniques . . . . .  | 19   |
| <b>References</b> . . . . .   | 23   |
| <b>Table 3.1. Powers and Roots</b> . . . . .  | 24   |
| $n^k$ , $k=1(1)10, 24, 1/2, 1/3, 1/4, 1/5$<br>$n=2(1)999$ , Exact or 10S  |      |

The author acknowledges the assistance of Peter J. O'Hara and Kermit C. Nelson in the preparation and checking of the table of powers and roots.

<sup>1</sup> National Bureau of Standards. (Deceased.)

### 3. Elementary Analytical Methods

#### 3.1. Binomial Theorem and Binomial Coefficients; Arithmetic and Geometric Progressions; Arithmetic, Geometric, Harmonic and Generalized Means

##### Binomial Theorem

3.1.1

$$(a+b)^n = a^n + \binom{n}{1} a^{n-1} b + \binom{n}{2} a^{n-2} b^2 + \binom{n}{3} a^{n-3} b^3 + \dots + b^n$$

( $n$  a positive integer)

##### Binomial Coefficients (see chapter 24)

3.1.2

$$* \binom{n}{k} = {}_n C_k = \frac{n(n-1)\dots(n-k+1)}{k!} = \frac{n!}{(n-k)!k!}$$

3.1.3  $\binom{n}{k} = \binom{n}{n-k} = (-1)^k \binom{k-n-1}{k}$

3.1.4  $\binom{n+1}{k} = \binom{n}{k} + \binom{n}{k-1}$

3.1.5  $\binom{n}{0} = \binom{n}{n} = 1$

3.1.6  $1 + \binom{n}{1} + \binom{n}{2} + \dots + \binom{n}{n} = 2^n$

3.1.7  $1 - \binom{n}{1} + \binom{n}{2} - \dots + (-1)^n \binom{n}{n} = 0$

##### Table of Binomial Coefficients $\binom{n}{k}$

3.1.8

| $n \backslash k$ | 0 | 1  | 2  | 3   | 4   | 5   | 6   | 7   | 8   | 9   | 10 | 11 | 12 |
|------------------|---|----|----|-----|-----|-----|-----|-----|-----|-----|----|----|----|
| 1                | 1 | 1  |    |     |     |     |     |     |     |     |    |    |    |
| 2                | 1 | 2  | 1  |     |     |     |     |     |     |     |    |    |    |
| 3                | 1 | 3  | 3  | 1   |     |     |     |     |     |     |    |    |    |
| 4                | 1 | 4  | 6  | 4   | 1   |     |     |     |     |     |    |    |    |
| 5                | 1 | 5  | 10 | 10  | 5   | 1   |     |     |     |     |    |    |    |
| 6                | 1 | 6  | 15 | 20  | 15  | 6   | 1   |     |     |     |    |    |    |
| 7                | 1 | 7  | 21 | 35  | 35  | 21  | 7   | 1   |     |     |    |    |    |
| 8                | 1 | 8  | 28 | 56  | 70  | 56  | 28  | 8   | 1   |     |    |    |    |
| 9                | 1 | 9  | 36 | 84  | 126 | 126 | 84  | 36  | 9   | 1   |    |    |    |
| 10               | 1 | 10 | 45 | 120 | 210 | 252 | 210 | 120 | 45  | 10  | 1  |    |    |
| 11               | 1 | 11 | 55 | 165 | 330 | 462 | 462 | 330 | 165 | 55  | 11 | 1  |    |
| 12               | 1 | 12 | 66 | 220 | 495 | 792 | 924 | 792 | 495 | 220 | 66 | 12 | 1  |

For a more extensive table see chapter 24.

\*See page II.

3.1.9

##### Sum of Arithmetic Progression to $n$ Terms

$$a + (a+d) + (a+2d) + \dots + (a+(n-1)d)$$

$$= na + \frac{1}{2} n(n-1)d = \frac{n}{2} (a+l),$$

last term in series =  $l = a + (n-1)d$

##### Sum of Geometric Progression to $n$ Terms

3.1.10

$$s_n = a + ar + ar^2 + \dots + ar^{n-1} = \frac{a(1-r^n)}{1-r}$$

$$\lim_{n \rightarrow \infty} s_n = a/(1-r) \quad (-1 < r < 1)$$

##### Arithmetic Mean of $n$ Quantities $A$

3.1.11

$$A = \frac{a_1 + a_2 + \dots + a_n}{n}$$

##### Geometric Mean of $n$ Quantities $G$

3.1.12  $G = (a_1 a_2 \dots a_n)^{1/n} \quad (a_k > 0, k=1, 2, \dots, n)$

##### Harmonic Mean of $n$ Quantities $H$

3.1.13

$$\frac{1}{H} = \frac{1}{n} \left( \frac{1}{a_1} + \frac{1}{a_2} + \dots + \frac{1}{a_n} \right) \quad (a_k > 0, k=1, 2, \dots, n)$$

##### Generalized Mean

3.1.14

$$M(t) = \left( \frac{1}{n} \sum_{k=1}^n a_k^t \right)^{1/t}$$

3.1.15

$$M(t) = 0 \quad (t < 0, \text{ some } a_k \text{ zero})$$

3.1.16

$$\lim_{t \rightarrow \infty} M(t) = \max. \quad (a_1, a_2, \dots, a_n) = \max. a$$

3.1.17

$$\lim_{t \rightarrow -\infty} M(t) = \min. \quad (a_1, a_2, \dots, a_n) = \min. a$$

3.1.18

$$\lim_{t \rightarrow 0} M(t) = G$$

3.1.19

$$M(1) = A$$

3.1.20

$$M(-1) = H$$

### 3.2. Inequalities

#### Relation Between Arithmetic, Geometric, Harmonic and Generalized Means

3.2.1

$$A \geq G \geq H, \text{ equality if and only if } a_1 = a_2 = \dots = a_n$$

3.2.2

$$\min. a < M(t) < \max. a$$

**3.2.3**  $\min. a < G < \max. a$   
equality holds if all  $a_k$  are equal, or  $t < 0$   
and an  $a_k$  is zero

**3.2.4**  $M(t) < M(s)$  if  $t < s$  unless all  $a_k$  are equal,  
or  $s < 0$  and an  $a_k$  is zero.

**Triangle Inequalities**

**3.2.5**  $|a_1| - |a_2| \leq |a_1 + a_2| \leq |a_1| + |a_2|$

**3.2.6**  $\left| \sum_{k=1}^n a_k \right| \leq \sum_{k=1}^n |a_k|$

**Chebyshev's Inequality**

If  $a_1 \geq a_2 \geq a_3 \geq \dots \geq a_n$   
 $b_1 \geq b_2 \geq b_3 \geq \dots \geq b_n$

**3.2.7**  $n \sum_{k=1}^n a_k b_k \geq \left( \sum_{k=1}^n a_k \right) \left( \sum_{k=1}^n b_k \right)$

**Hölder's Inequality for Sums**

If  $\frac{1}{p} + \frac{1}{q} = 1, p > 1, q > 1$

**3.2.8**  $\sum_{k=1}^n |a_k b_k| \leq \left( \sum_{k=1}^n |a_k|^p \right)^{1/p} \left( \sum_{k=1}^n |b_k|^q \right)^{1/q}$ ;

equality holds if and only if  $|b_k| = c|a_k|^{p-1}$  ( $c = \text{constant} > 0$ ). If  $p = q = 2$  we get

**Cauchy's Inequality**

**3.2.9**  $\left[ \sum_{k=1}^n a_k b_k \right]^2 \leq \sum_{k=1}^n a_k^2 \sum_{k=1}^n b_k^2$  (equality for  $a_k = c b_k$ ,  
 $c$  constant).

**Hölder's Inequality for Integrals**

If  $\frac{1}{p} + \frac{1}{q} = 1, p > 1, q > 1$

**3.2.10**  $\int_a^b |f(x)g(x)| dx \leq \left[ \int_a^b |f(x)|^p dx \right]^{1/p} \left[ \int_a^b |g(x)|^q dx \right]^{1/q}$

equality holds if and only if  $|g(x)| = c|f(x)|^{p-1}$   
( $c = \text{constant} > 0$ ).

If  $p = q = 2$  we get

**Schwarz's Inequality**

**3.2.11**  $\left[ \int_a^b f(x)g(x) dx \right]^2 \leq \int_a^b [f(x)]^2 dx \int_a^b [g(x)]^2 dx$

**Minkowski's Inequality for Sums**

If  $p > 1$  and  $a_k, b_k > 0$  for all  $k$ ,

**3.2.12**

$$\left( \sum_{k=1}^n (a_k + b_k)^p \right)^{1/p} \leq \left( \sum_{k=1}^n a_k^p \right)^{1/p} + \left( \sum_{k=1}^n b_k^p \right)^{1/p},$$

equality holds if and only if  $b_k = c a_k$  ( $c = \text{constant} > 0$ ).

**Minkowski's Inequality for Integrals**

If  $p > 1$ ,

**3.2.13**

$$\left( \int_a^b |f(x) + g(x)|^p dx \right)^{1/p} \leq \left( \int_a^b |f(x)|^p dx \right)^{1/p} + \left( \int_a^b |g(x)|^p dx \right)^{1/p}$$

equality holds if and only if  $g(x) = c f(x)$  ( $c = \text{constant} > 0$ ).

**3.3. Rules for Differentiation and Integration Derivatives**

**3.3.1**  $\frac{d}{dx} (cu) = c \frac{du}{dx}, c$  constant

**3.3.2**  $\frac{d}{dx} (u+v) = \frac{du}{dx} + \frac{dv}{dx}$

**3.3.3**  $\frac{d}{dx} (uv) = u \frac{dv}{dx} + v \frac{du}{dx}$

**3.3.4**  $\frac{d}{dx} (u/v) = \frac{v du/dx - u dv/dx}{v^2}$

**3.3.5**  $\frac{d}{dx} u(v) = \frac{du}{dv} \frac{dv}{dx}$

**3.3.6**  $\frac{d}{dx} (u^v) = u^v \left( \frac{v}{u} \frac{du}{dx} + \ln u \frac{dv}{dx} \right)$

**Leibniz's Theorem for Differentiation of an Integral**

**3.3.7**

$$\frac{d}{dc} \int_{a(c)}^{b(c)} f(x, c) dx = \int_{a(c)}^{b(c)} \frac{\partial}{\partial c} f(x, c) dx + f(b, c) \frac{db}{dc} - f(a, c) \frac{da}{dc}$$

**Leibniz's Theorem for Differentiation of a Product**

3.3.8

$$\frac{d^n}{dx^n}(uv) = \frac{d^n u}{dx^n} v + \binom{n}{1} \frac{d^{n-1} u}{dx^{n-1}} \frac{dv}{dx} + \binom{n}{2} \frac{d^{n-2} u}{dx^{n-2}} \frac{d^2 v}{dx^2} \\ + \dots + \binom{n}{r} \frac{d^{n-r} u}{dx^{n-r}} \frac{d^r v}{dx^r} + \dots + u \frac{d^n v}{dx^n}$$

3.3.9

$$\frac{dx}{dy} = 1 / \frac{dy}{dx}$$

3.3.10

$$\frac{d^2 x}{dy^2} = -\frac{d^2 y}{dx^2} \left(\frac{dy}{dx}\right)^{-3}$$

3.3.11

$$\frac{d^3 x}{dy^3} = -\left[\frac{d^3 y}{dx^3} \frac{dy}{dx} - 3 \left(\frac{d^2 y}{dx^2}\right)^2\right] \left(\frac{dy}{dx}\right)^{-5}$$

**Integration by Parts**

3.3.12

$$\int u dv = uv - \int v du$$

3.3.13

$$\int u v dx = \left(\int u dx\right) v - \int \left(\int u dx\right) \frac{dv}{dx} dx$$

**Integrals of Rational Algebraic Functions**

(Integration constants are omitted)

$$3.3.14 \quad \int (ax+b)^n dx = \frac{(ax+b)^{n+1}}{a(n+1)} \quad (n \neq -1)$$

$$3.3.15 \quad \int \frac{dx}{ax+b} = \frac{1}{a} \ln |ax+b|$$

The following formulas are useful for evaluating

$$\int \frac{P(x) dx}{(ax^2+bx+c)^n}$$
where  $P(x)$  is a polynomial and  $n > 1$  is an integer.

3.3.16

$$\int \frac{dx}{(ax^2+bx+c)} = \frac{2}{(4ac-b^2)^{\frac{1}{2}}} \arctan \frac{2ax+b}{(4ac-b^2)^{\frac{1}{2}}} \\ (b^2-4ac < 0)$$

3.3.17

$$= \frac{1}{(b^2-4ac)^{\frac{1}{2}}} \ln \left| \frac{2ax+b-(b^2-4ac)^{\frac{1}{2}}}{2ax+b+(b^2-4ac)^{\frac{1}{2}}} \right| \\ (b^2-4ac > 0)$$

3.3.18

$$= \frac{-2}{2ax+b} \quad (b^2-4ac=0)$$

3.3.19

$$\int \frac{x dx}{ax^2+bx+c} = \frac{1}{2a} \ln |ax^2+bx+c| - \frac{b}{2a} \int \frac{dx}{ax^2+bx+c}$$

3.3.20

$$\int \frac{dx}{(a+bx)(c+dx)} = \frac{1}{ad-bc} \ln \left| \frac{c+dx}{a+bx} \right| \quad (ad \neq bc)$$

3.3.21

$$\int \frac{dx}{a^2+b^2x^2} = \frac{1}{ab} \arctan \frac{bx}{a}$$

3.3.22

$$\int \frac{x dx}{a^2+b^2x^2} = \frac{1}{2b^2} \ln |a^2+b^2x^2|$$

3.3.23

$$\int \frac{dx}{a^2-b^2x^2} = \frac{1}{2ab} \ln \left| \frac{a+bx}{a-bx} \right|$$

3.3.24

$$\int \frac{dx}{(x^2+a^2)^2} = \frac{1}{2a^3} \arctan \frac{x}{a} + \frac{x}{2a^2(x^2+a^2)}$$

3.3.25

$$\int \frac{dx}{(x^2-a^2)^2} = \frac{-x}{2a^2(x^2-a^2)} + \frac{1}{4a^3} \ln \left| \frac{a+x}{a-x} \right|$$

**Integrals of Irrational Algebraic Functions**

$$3.3.26 \quad \int \frac{dx}{[(a+bx)(c+dx)]^{1/2}} = \frac{2}{(-bd)^{1/2}} \arctan \left[ \frac{-d(a+bx)}{b(c+dx)} \right]^{1/2} \quad (bd < 0)$$

$$3.3.27 \quad = \frac{-1}{(-bd)^{1/2}} \arcsin \left( \frac{2bdx+ad+bc}{bc-ad} \right) \quad (b > 0, d < 0)$$

$$3.3.28 \quad = \frac{2}{(bd)^{1/2}} \ln |[bd(a+bx)]^{1/2} + b(c+dx)^{1/2}| \quad (bd > 0)$$

$$3.3.29 \quad \int \frac{dx}{(a+bx)^{1/2}(c+dx)} = \frac{2}{[d(bc-ad)]^{1/2}} \arctan \left[ \frac{d(a+bx)}{(bc-ad)} \right]^{1/2} \quad (d(ad-bc) < 0)$$

$$3.3.30 \quad = \frac{1}{[d(ad-bc)]^{1/2}} \ln \left| \frac{d(a+bx)^{1/2} - [d(ad-bc)]^{1/2}}{d(a+bx)^{1/2} + [d(ad-bc)]^{1/2}} \right| \quad (d(ad-bc) > 0)$$

3.3.31

$$\int [(a+bx)(c+dx)]^{1/2} dx = \frac{(ad-bc)+2b(c+dx)}{4bd} [(a+bx)(c+dx)]^{1/2} - \frac{(ad-bc)^2}{8bd} \int \frac{dx}{[(a+bx)(c+dx)]^{1/2}}$$

3.3.32

$$\int \left[ \frac{c+dx}{a+bx} \right]^{1/2} dx = \frac{1}{b} [(a+bx)(c+dx)]^{1/2} - \frac{(ad-bc)}{2b} \int \frac{dx}{[(a+bx)(c+dx)]^{1/2}}$$

3.3.33

$$\int \frac{dx}{(ax^2+bx+c)^{1/2}} = a^{-1/2} \ln |2a^{1/2}(ax^2+bx+c)^{1/2} + 2ax+b| \quad (a>0)$$

3.3.34  $= a^{-1/2} \operatorname{arcsinh} \frac{(2ax+b)}{(4ac-b^2)^{1/2}} \quad (a>0, 4ac>b^2)$

3.3.35  $= a^{-1/2} \ln |2ax+b| \quad (a>0, b^2=4ac)$

3.3.36  $= -(-a)^{-1/2} \operatorname{arcsin} \frac{(2ax+b)}{(b^2-4ac)^{1/2}} \quad (a<0, b^2>4ac, |2ax+b| < (b^2-4ac)^{1/2})$

3.3.37

$$\int (ax^2+bx+c)^{1/2} dx = \frac{2ax+b}{4a} (ax^2+bx+c)^{1/2} + \frac{4ac-b^2}{8a} \int \frac{dx}{(ax^2+bx+c)^{1/2}}$$

3.3.38

$$\int \frac{dx}{x(ax^2+bx+c)^{1/2}} = - \int \frac{dt}{(a+bt+ct^2)^{1/2}} \text{ where } t=1/x$$

3.3.39

$$\int \frac{xdx}{(ax^2+bx+c)^{1/2}} = \frac{1}{a} (ax^2+bx+c)^{1/2} - \frac{b}{2a} \int \frac{dx}{(ax^2+bx+c)^{1/2}}$$

3.3.40  $\int \frac{dx}{(x^2 \pm a^2)^{1/2}} = \ln |x + (x^2 \pm a^2)^{1/2}|$

3.3.41

$$\int (x^2 \pm a^2)^{1/2} dx = \frac{x}{2} (x^2 \pm a^2)^{1/2} \pm \frac{a^2}{2} \ln |x + (x^2 \pm a^2)^{1/2}|$$

3.3.42  $\int \frac{dx}{x(x^2+a^2)^{1/2}} = -\frac{1}{a} \ln \left| \frac{a+(x^2+a^2)^{1/2}}{x} \right|$

3.3.43  $\int \frac{dx}{x(x^2-a^2)^{1/2}} = \frac{1}{a} \operatorname{arccos} \frac{a}{x}$

3.3.44  $\int \frac{dx}{(a^2-x^2)^{1/2}} = \operatorname{arcsin} \frac{x}{a}$

3.3.45  $\int (a^2-x^2)^{1/2} dx = \frac{x}{2} (a^2-x^2)^{1/2} + \frac{a^2}{2} \operatorname{arcsin} \frac{x}{a}$

3.3.46  $\int \frac{dx}{x(a^2-x^2)^{1/2}} = -\frac{1}{a} \ln \left| \frac{a+(a^2-x^2)^{1/2}}{x} \right|$

3.3.47  $\int \frac{dx}{(2ax-x^2)^{1/2}} = \operatorname{arcsin} \frac{x-a}{a}$

3.3.48

$$\int (2ax-x^2)^{1/2} dx = \frac{(x-a)}{2} (2ax-x^2)^{1/2} + \frac{a^2}{2} \operatorname{arcsin} \frac{x-a}{a}$$

3.3.49

$$\int \frac{dx}{(ax^2+b)(cx^2+d)^{1/2}} = \frac{1}{[b(ad-bc)]^{1/2}} \operatorname{arctan} \frac{x(ad-bc)^{1/2}}{[b(cx^2+d)]^{1/2}} \quad (ad>bc)$$

3.3.50

$$= \frac{1}{2[b(bc-ad)]^{1/2}} \ln \left| \frac{[b(cx^2+d)]^{1/2} + x(bc-ad)^{1/2}}{[b(cx^2+d)]^{1/2} - x(bc-ad)^{1/2}} \right| \quad (bc>ad)$$

### 3.4. Limits, Maxima and Minima

#### Indeterminate Forms (L'Hospital's Rule)

3.4.1 Let  $f(x)$  and  $g(x)$  be differentiable on an interval  $a \leq x < b$  for which  $g'(x) \neq 0$ .

If

$$\lim_{x \rightarrow b^-} f(x) = 0 \text{ and } \lim_{x \rightarrow b^-} g(x) = 0$$

or if

$$\lim_{x \rightarrow b^-} f(x) = \infty \text{ and } \lim_{x \rightarrow b^-} g(x) = \infty$$

and if

$$\lim_{x \rightarrow b^-} \frac{f'(x)}{g'(x)} = l \text{ then } \lim_{x \rightarrow b^-} \frac{f(x)}{g(x)} = l.$$

Both  $b$  and  $l$  may be finite or infinite.

## Maxima and Minima

## 3.4.2 (1) Functions of One Variable

The function  $y=f(x)$  has a maximum at  $x=x_0$  if  $f'(x_0)=0$  and  $f''(x_0)<0$ , and a minimum at  $x=x_0$  if  $f'(x_0)=0$  and  $f''(x_0)>0$ . Points  $x_0$  for which  $f'(x_0)=0$  are called stationary points.

## 3.4.3 (2) Functions of Two Variables

The function  $f(x, y)$  has a maximum or minimum for those values of  $(x_0, y_0)$  for which

$$\frac{\partial f}{\partial x}=0, \frac{\partial f}{\partial y}=0,$$

and for which  $\left| \begin{array}{cc} \frac{\partial^2 f}{\partial x \partial y} & \frac{\partial^2 f}{\partial x^2} \\ \frac{\partial^2 f}{\partial y^2} & \frac{\partial^2 f}{\partial x \partial y} \end{array} \right| < 0$ ;

(a)  $f(x, y)$  has a maximum

if  $\frac{\partial^2 f}{\partial x^2} < 0$  and  $\frac{\partial^2 f}{\partial y^2} < 0$  at  $(x_0, y_0)$ ,

(b)  $f(x, y)$  has a minimum

if  $\frac{\partial^2 f}{\partial x^2} > 0$  and  $\frac{\partial^2 f}{\partial y^2} > 0$  at  $(x_0, y_0)$ .

## 3.5. Absolute and Relative Errors

(1) If  $x_0$  is an approximation to the true value of  $x$ , then

3.5.1 (a) the absolute error of  $x_0$  is  $\Delta x = x_0 - x$ ,  $x - x_0$  is the correction to  $x$ .

3.5.2 (b) the relative error of  $x_0$  is  $\delta x = \frac{\Delta x}{x} \approx \frac{\Delta x}{x_0}$

3.5.3 (c) the percentage error is 100 times the relative error.

3.5.4 (2) The absolute error of the sum or difference of several numbers is at most equal to the sum of the absolute errors of the individual numbers.

3.5.5 (3) If  $f(x_1, x_2, \dots, x_n)$  is a function of  $x_1, x_2, \dots, x_n$  and the absolute error in  $x_i$  ( $i=1, 2, \dots, n$ ) is  $\Delta x_i$ , then the absolute error in  $f$  is

$$\Delta f \approx \frac{\partial f}{\partial x_1} \Delta x_1 + \frac{\partial f}{\partial x_2} \Delta x_2 + \dots + \frac{\partial f}{\partial x_n} \Delta x_n$$

3.5.6 (4) The relative error of the product or quotient of several factors is at most equal to the sum of the relative errors of the individual factors.

## 3.5.7

(5) If  $y=f(x)$ , the relative error  $\delta y = \frac{\Delta y}{y} \approx \frac{f'(x)}{f(x)} \Delta x$

## Approximate Values

If  $|\epsilon| \ll 1, |\eta| \ll 1, b \ll a$ ,

$$3.5.8 \quad (a+b)^k \approx a^k + ka^{k-1}b$$

$$3.5.9 \quad (1+\epsilon)(1+\eta) \approx 1+\epsilon+\eta$$

$$3.5.10 \quad \frac{1+\epsilon}{1+\eta} \approx 1+\epsilon-\eta$$

## 3.6. Infinite Series

## Taylor's Formula for a Single Variable

## 3.6.1

$$f(x+h) = f(x) + hf'(x) + \frac{h^2}{2!} f''(x) + \dots + \frac{h^{n-1}}{(n-1)!} f^{(n-1)}(x) + R_n$$

## 3.6.2

$$R_n = \frac{h^n}{n!} f^{(n)}(x+\theta_1 h) = \frac{h^n}{(n-1)!} (1-\theta_2)^{n-1} f^{(n)}(x+\theta_2 h) \quad (0 < \theta_{1,2}(x) < 1)$$

## 3.6.3

$$= \frac{h^n}{(n-1)!} \int_0^1 (1-t)^{n-1} f^{(n)}(x+th) dt$$

## 3.6.4

$$f(x) = f(a) + \frac{(x-a)}{1!} f'(a) + \frac{(x-a)^2}{2!} f''(a) + \dots + \frac{(x-a)^{n-1}}{(n-1)!} f^{(n-1)}(a) + R_n$$

## 3.6.5

$$R_n = \frac{(x-a)^n}{n!} f^{(n)}(\xi) \quad (a < \xi < x)$$

## Lagrange's Expansion

If  $y=f(x)$ ,  $y_0=f(x_0)$ ,  $f'(x_0) \neq 0$ , then

## 3.6.6

$$x = x_0 + \sum_{k=1}^{\infty} \frac{(y-y_0)^k}{k!} \left[ \frac{d^{k-1}}{dx^{k-1}} \left\{ \frac{x-x_0}{f(x)-y_0} \right\}^k \right]_{x=x_0}$$

## 3.6.7

$$g(x) = g(x_0) + \sum_{k=1}^{\infty} \frac{(y-y_0)^k}{k!} \left[ \frac{d^{k-1}}{dx^{k-1}} \left( g'(x) \left\{ \frac{x-x_0}{f(x)-y_0} \right\}^k \right) \right]_{x=x_0}$$

where  $g(x)$  is any function indefinitely differentiable.

## Binomial Series

## 3.6.8

$$(1+x)^a = \sum_{l=0}^{\infty} \binom{a}{l} x^l \quad (-1 < x < 1)$$

3.6.9

$$(1+x)^\alpha = 1 + \alpha x + \frac{\alpha(\alpha-1)}{2!} x^2 + \frac{\alpha(\alpha-1)(\alpha-2)}{3!} x^3 + \dots$$

3.6.10

$$(1+x)^{-1} = 1 - x + x^2 - x^3 + x^4 - \dots \quad (-1 < x < 1)$$

3.6.11

$$(1+x)^{\frac{1}{2}} = 1 + \frac{x}{2} - \frac{x^2}{8} + \frac{x^3}{16} - \frac{5x^4}{128} + \frac{7x^5}{256} - \frac{21x^6}{1024} + \dots$$

( $-1 < x < 1$ )

3.6.12

$$(1+x)^{-\frac{1}{2}} = 1 - \frac{x}{2} + \frac{3x^2}{8} - \frac{5x^3}{16} + \frac{35x^4}{128} - \frac{63x^5}{256} + \frac{231x^6}{1024} - \dots$$

( $-1 < x < 1$ )

3.6.13

$$(1+x)^{\frac{1}{3}} = 1 + \frac{1}{3}x - \frac{1}{9}x^2 + \frac{5}{81}x^3 - \frac{10}{243}x^4 + \frac{22}{729}x^5 - \frac{154}{6561}x^6 + \dots$$

( $-1 < x < 1$ )

3.6.14

$$(1+x)^{-\frac{1}{3}} = 1 - \frac{1}{3}x + \frac{2}{9}x^2 - \frac{14}{81}x^3 + \frac{35}{243}x^4 - \frac{91}{729}x^5 + \frac{728}{6561}x^6 - \dots$$

( $-1 < x < 1$ )

Asymptotic Expansions

3.6.15 A series  $\sum_{k=0}^{\infty} a_k x^{-k}$  is said to be an asymptotic expansion of a function  $f(x)$  if

$$f(x) - \sum_{k=0}^{n-1} a_k x^{-k} = O(x^{-n}) \text{ as } x \rightarrow \infty$$

for every  $n=1, 2, \dots$ . We write

$$f(x) \sim \sum_{k=0}^{\infty} a_k x^{-k}.$$

The series itself may be either convergent or divergent.

Operations With Series

$$\begin{aligned} \text{Let } s_1 &= 1 + a_1x + a_2x^2 + a_3x^3 + a_4x^4 + \dots \\ s_2 &= 1 + b_1x + b_2x^2 + b_3x^3 + b_4x^4 + \dots \\ s_3 &= 1 + c_1x + c_2x^2 + c_3x^3 + c_4x^4 + \dots \end{aligned}$$

|        | Operation                  | $c_1$             | $c_2$                               | $c_3$  | $c_4$  |
|--------|----------------------------|-------------------|-------------------------------------|--|--|
| 3.6.16 | $s_3 = s_1^{-1}$           | $-a_1$            | $a_1^2 - a_2$                       | $2a_1a_2 - a_3 - a_1^3$                                  | $2a_1a_3 - 3a_1^2a_2 - a_4 + a_2^2 + a_1^4$  |
| 3.6.17 | $s_3 = s_1^{-2}$           | $-2a_1$           | $3a_1^2 - 2a_2$                     | $6a_1a_2 - 2a_3 - 4a_1^3$                                | $6a_1a_3 + 3a_2^2 - 2a_4 - 12a_1^2a_2 + 5a_1^4$  |
| 3.6.18 | $s_3 = s_1^{\frac{1}{2}}$  | $\frac{1}{2}a_1$  | $\frac{1}{2}a_2 - \frac{1}{8}a_1^2$ | $\frac{1}{2}a_3 - \frac{1}{4}a_1a_2 + \frac{1}{16}a_1^3$ | $\frac{1}{2}a_4 - \frac{1}{4}a_1a_3 - \frac{1}{8}a_2^2 + \frac{3}{16}a_1^2a_2 - \frac{5}{128}a_1^4$                  |
| 3.6.19 | $s_3 = s_1^{-\frac{1}{2}}$ | $-\frac{1}{2}a_1$ | $\frac{3}{8}a_1^2 - \frac{1}{2}a_2$ | $\frac{3}{4}a_1a_2 - \frac{1}{2}a_3 - \frac{5}{16}a_1^3$ | $\frac{3}{4}a_1a_3 + \frac{3}{8}a_2^2 - \frac{1}{2}a_4 - \frac{15}{16}a_1^2a_2 + \frac{35}{128}a_1^4$                |
| 3.6.20 | $s_3 = s_1^n$              | $na_1$            | $\frac{1}{2}(n-1)c_1a_1 + na_2$ *   | $c_1a_2(n-1) + \frac{1}{6}c_1a_1^2(n-1)(n-2) + na_3$ *   | $na_4 + c_1a_3(n-1) + \frac{1}{2}n(n-1)a_2^2 + \frac{1}{2}(n-1)(n-2)c_1a_1a_2 + \frac{1}{24}(n-1)(n-2)(n-3)c_1a_1^3$ |
| 3.6.21 | $s_3 = s_1s_2$             | $a_1 + b_1$       | $b_2 + a_1b_1 + a_2$                | $b_3 + a_1b_2 + a_2b_1 + a_3$                            | $b_4 + a_1b_3 + a_2b_2 + a_3b_1 + a_4$   |
| 3.6.22 | $s_3 = s_1/s_2$            | $a_1 - b_1$       | $a_2 - (b_1c_1 + b_2)$              | $a_3 - (b_1c_2 + b_2c_1 + b_3)$                          | $a_4 - (b_1c_3 + b_2c_2 + b_3c_1 + b_4)$   |
| 3.6.23 | $s_3 = \exp(s_1 - 1)$      | $a_1$             | $a_2 + \frac{1}{2}a_1^2$            | $a_3 + a_1a_2 + \frac{1}{6}a_1^3$                        | $a_4 + a_1a_3 + \frac{1}{2}a_2^2 + \frac{1}{2}a_2a_1^2 + \frac{1}{24}a_1^4$  |
| 3.6.24 | $s_3 = 1 + \ln s_1$        | $a_1$             | $a_2 - \frac{1}{2}a_1c_1$           | $a_3 - \frac{1}{3}(a_2c_1 + 2a_1c_2)$                    | $a_4 - \frac{1}{4}(a_3c_1 + 2a_2c_2 + 3a_1c_3)$ *  |

## Reversion of Series

## 3.6.25 Given

$$y = ax + bx^2 + cx^3 + dx^4 + ex^5 + fx^6 + gx^7 + \dots$$

then

$$x = Ay + By^2 + Cy^3 + Dy^4 + Ey^5 + Fy^6 + Gy^7 + \dots$$

where

$$aA = 1$$

$$a^3B = -b$$

$$a^5C = 2b^2 - ac$$

$$a^7D = 5abc - a^2d - 5b^3$$

$$a^9E = 6a^2bd + 3a^2c^2 + 14b^4 - a^3e - 21ab^2c$$

$$a^{11}F = 7a^3be + 7a^3cd + 84ab^3c - a^4f \\ - 28a^2bc^2 - 42b^5 - 28a^2b^2d$$

$$a^{13}G = 8a^4bf + 8a^4ce + 4a^4d^2 + 120a^2b^3d \\ + 180a^2b^2c^2 + 132b^6 - a^5g - 36a^3b^2e \\ - 72a^3bcd - 12a^3c^3 - 330ab^4c$$

## Kummer's Transformation of Series

3.6.26 Let  $\sum_{k=0}^{\infty} a_k = s$  be a given convergent series and  $\sum_{k=0}^{\infty} c_k = c$  be a given convergent series with known sum  $c$  such that  $\lim_{k \rightarrow \infty} \frac{a_k}{c_k} = \lambda \neq 0$ .

Then

$$s = \lambda c + \sum_{k=0}^{\infty} \left(1 - \lambda \frac{c_k}{a_k}\right) a_k.$$

## Euler's Transformation of Series

3.6.27 If  $\sum_{k=0}^{\infty} (-1)^k a_k = a_0 - a_1 + a_2 - \dots$  is a convergent series with sum  $s$  then

$$s = \sum_{k=0}^{\infty} \frac{(-1)^k \Delta^k a_0}{2^{k+1}}, \quad \Delta^k a_0 = \sum_{m=0}^k (-1)^m \binom{k}{m} a_{k-m}$$

## Euler-Maclaurin Summation Formula

## 3.6.28

$$\sum_{k=1}^{n-1} f_k = \int_0^n f(k) dk - \frac{1}{2} [f(0) + f(n)] + \frac{1}{12} [f'(n) - f'(0)] \\ - \frac{1}{720} [f'''(n) - f'''(0)] + \frac{1}{30240} [f^{(v)}(n) - f^{(v)}(0)] \\ - \frac{1}{1209600} [f^{(vii)}(n) - f^{(vii)}(0)] + \dots$$

## 3.7. Complex Numbers and Functions

## Cartesian Form

3.7.1  $z = x + iy$

## Polar Form

3.7.2  $z = re^{i\theta} = r(\cos \theta + i \sin \theta)$

3.7.3 *Modulus:*  $|z| = (x^2 + y^2)^{1/2} = r$

3.7.4 *Argument:*  $\arg z = \arctan (y/x) = \theta$  (other notations for  $\arg z$  are  $\text{am } z$  and  $\text{ph } z$ ).

3.7.5 *Real Part:*  $x = \Re z = r \cos \theta$

3.7.6 *Imaginary Part:*  $y = \Im z = r \sin \theta$

Complex Conjugate of  $z$ 

3.7.7  $\bar{z} = x - iy$

3.7.8  $|\bar{z}| = |z|$

3.7.9  $\arg \bar{z} = -\arg z$

## Multiplication and Division

If  $z_1 = x_1 + iy_1$ ,  $z_2 = x_2 + iy_2$ , then

3.7.10  $z_1 z_2 = x_1 x_2 - y_1 y_2 + i(x_1 y_2 + x_2 y_1)$

3.7.11  $|z_1 z_2| = |z_1| |z_2|$

3.7.12  $\arg (z_1 z_2) = \arg z_1 + \arg z_2$

3.7.13  $\frac{z_1}{z_2} = \frac{z_1 \bar{z}_2}{|z_2|^2} = \frac{x_1 x_2 + y_1 y_2 + i(x_2 y_1 - x_1 y_2)}{x_2^2 + y_2^2}$

3.7.14  $\left| \frac{z_1}{z_2} \right| = \frac{|z_1|}{|z_2|}$

3.7.15  $\arg \left( \frac{z_1}{z_2} \right) = \arg z_1 - \arg z_2$

## Powers

3.7.16  $z^n = r^n e^{in\theta}$

3.7.17  $= r^n \cos n\theta + ir^n \sin n\theta$   
( $n = 0, \pm 1, \pm 2, \dots$ )

3.7.18  $z^2 = x^2 - y^2 + i(2xy)$

3.7.19  $z^3 = x^3 - 3xy^2 + i(3x^2y - y^3)$

3.7.20  $z^4 = x^4 - 6x^2y^2 + y^4 + i(4x^3y - 4xy^3)$

3.7.21  $z^5 = x^5 - 10x^3y^2 + 5xy^4 + i(5x^4y - 10x^2y^3 + y^5)$

## 3.7.22

$$z^n = [x^n - \binom{n}{2} x^{n-2} y^2 + \binom{n}{4} x^{n-4} y^4 - \dots]$$

$$+ i [\binom{n}{1} x^{n-1} y - \binom{n}{3} x^{n-3} y^3 + \dots],$$

( $n = 1, 2, \dots$ )



If  $z^n = u_n + iv_n$ , then  $z^{n+1} = u_{n+1} + iv_{n+1}$  where

3.7.23  $u_{n+1} = xu_n - yv_n$ ;  $v_{n+1} = xv_n + yu_n$   
 $\mathcal{R}z^n$  and  $\mathcal{I}z^n$  are called harmonic polynomials.

3.7.24 
$$\frac{1}{z} = \frac{\bar{z}}{|z|^2} = \frac{x-iy}{x^2+y^2}$$

3.7.25 
$$\frac{1}{z^n} = \frac{\bar{z}^n}{|z|^{2n}} = (z^{-1})^n$$

**Roots**

3.7.26 
$$z^{\frac{1}{n}} = \sqrt[n]{z} = r^{\frac{1}{n}} e^{i\theta/n} = r^{\frac{1}{n}} \cos \frac{1}{n}\theta + i r^{\frac{1}{n}} \sin \frac{1}{n}\theta$$

If  $-\pi < \theta \leq \pi$  this is the principal root. The other root has the opposite sign. The principal root is given by

3.7.27 
$$z^{\frac{1}{n}} = [\frac{1}{2}(r+x)]^{\frac{1}{n}} \pm i [\frac{1}{2}(r-x)]^{\frac{1}{n}} = u \pm iv$$
 where  $2uv = y$  and where the ambiguous sign is taken to be the same as the sign of  $y$ .

3.7.28 
$$z^{1/n} = r^{1/n} e^{i\theta/n}$$
, (principal root if  $-\pi < \theta \leq \pi$ ). Other roots are  $r^{1/n} e^{i(\theta+2\pi k)/n}$  ( $k=1, 2, 3, \dots, n-1$ ).

**Inequalities**

3.7.29 
$$\left| |z_1| - |z_2| \right| \leq |z_1 \pm z_2| \leq |z_1| + |z_2|$$

**Complex Functions, Cauchy-Riemann Equations**

$f(z) = f(x+iy) = u(x, y) + iv(x, y)$  where  $u(x, y), v(x, y)$  are real, is *analytic* at those points  $z = x + iy$  at which

3.7.30 
$$\frac{\partial u}{\partial x} = \frac{\partial v}{\partial y}, \quad \frac{\partial u}{\partial y} = -\frac{\partial v}{\partial x}$$

If  $z = re^{i\theta}$ ,

3.7.31 
$$\frac{\partial u}{\partial r} = \frac{1}{r} \frac{\partial v}{\partial \theta}, \quad \frac{1}{r} \frac{\partial u}{\partial \theta} = -\frac{\partial v}{\partial r}$$

**Laplace's Equation**

The functions  $u(x, y)$  and  $v(x, y)$  are called harmonic functions and satisfy Laplace's equation:

**Cartesian Coordinates**

3.7.32 
$$\frac{\partial^2 u}{\partial x^2} + \frac{\partial^2 u}{\partial y^2} = \frac{\partial^2 v}{\partial x^2} + \frac{\partial^2 v}{\partial y^2} = 0$$

**Polar Coordinates**

3.7.33 
$$r \frac{\partial}{\partial r} \left( r \frac{\partial u}{\partial r} \right) + \frac{\partial^2 u}{\partial \theta^2} = r \frac{\partial}{\partial r} \left( r \frac{\partial v}{\partial r} \right) + \frac{\partial^2 v}{\partial \theta^2} = 0$$

**3.8. Algebraic Equations**

**Solution of Quadratic Equations**

3.8.1 Given  $az^2 + bz + c = 0$ ,

$$z_{1,2} = -\left(\frac{b}{2a}\right) \pm \frac{1}{2a} q^{\frac{1}{2}}, \quad q = b^2 - 4ac,$$

$$z_1 + z_2 = -b/a, \quad z_1 z_2 = c/a$$

If  $q > 0$ , two real roots,  
 $q = 0$ , two equal roots,  
 $q < 0$ , pair of complex conjugate roots.

**Solution of Cubic Equations**

3.8.2 Given  $z^3 + a_2 z^2 + a_1 z + a_0 = 0$ , let

$$q = \frac{1}{3} a_1 - \frac{1}{9} a_2^2, \quad r = \frac{1}{6} (a_1 a_2 - 3a_0) - \frac{1}{27} a_2^3.$$

If  $q^3 + r^2 > 0$ , one real root and a pair of complex conjugate roots,

$q^3 + r^2 = 0$ , all roots real and at least two are equal,

$q^3 + r^2 < 0$ , all roots real (irreducible case).

Let

$$s_1 = [r + (q^3 + r^2)^{\frac{1}{3}}]^{\frac{1}{3}}, \quad s_2 = [r - (q^3 + r^2)^{\frac{1}{3}}]^{\frac{1}{3}}$$

then

$$z_1 = (s_1 + s_2) - \frac{a_2}{3}$$

$$z_2 = -\frac{1}{2} (s_1 + s_2) - \frac{a_2}{3} + \frac{i\sqrt{3}}{2} (s_1 - s_2)$$

$$z_3 = -\frac{1}{2} (s_1 + s_2) - \frac{a_2}{3} - \frac{i\sqrt{3}}{2} (s_1 - s_2).$$

If  $z_1, z_2, z_3$  are the roots of the cubic equation

$$z_1 + z_2 + z_3 = -a_2$$

$$z_1 z_2 + z_1 z_3 + z_2 z_3 = a_1$$

$$z_1 z_2 z_3 = -a_0$$

**Solution of Quartic Equations**

3.8.3 Given  $z^4 + a_3 z^3 + a_2 z^2 + a_1 z + a_0 = 0$ , find the real root  $u_1$  of the cubic equation

$$u^3 - a_2 u^2 + (a_1 a_3 - 4a_0)u - (a_1^2 + a_0 a_3^2 - 4a_0 a_2) = 0$$

and determine the four roots of the quartic as solutions of the two quadratic equations

$$v^2 + \left[ \frac{a_3}{2} \mp \left( \frac{a_3^2}{4} + u_1 - a_2 \right)^{\frac{1}{2}} \right] v + \frac{u_1}{2} \mp \left[ \left( \frac{u_1}{2} \right)^2 - a_0 \right]^{\frac{1}{2}} = 0$$

If all roots of the cubic equation are real, use the value of  $u_1$  which gives real coefficients in the \*quadratic equation and select signs so that if

$$z^4 + a_3z^3 + a_2z^2 + a_1z + a_0 = (z^2 + p_1z + q_1)(z^2 + p_2z + q_2),$$

then

$$p_1 + p_2 = a_3, p_1p_2 + q_1 + q_2 = a_2, p_1q_2 + p_2q_1 = a_1, q_1q_2 = a_0.$$

If  $z_1, z_2, z_3, z_4$  are the roots,

$$\sum z_i = -a_3, \sum z_i z_j z_k = -a_1,$$

$$\sum z_i z_j = a_2, z_1 z_2 z_3 z_4 = a_0.$$

### 3.9. Successive Approximation Methods

#### General Comments

**3.9.1** Let  $x = x_1$  be an approximation to  $x = \xi$  where  $f(\xi) = 0$  and both  $x_1$  and  $\xi$  are in the interval  $a \leq x \leq b$ . We define

$$x_{n+1} = x_n + c_n f(x_n) \quad (n = 1, 2, \dots).$$

Then, if  $f'(x) \geq 0$  and the constants  $c_n$  are negative and bounded, the sequence  $x_n$  converges monotonically to the root  $\xi$ .

If  $c_n = c = \text{constant} < 0$  and  $f'(x) > 0$ , then the process converges but not necessarily monotonically.

#### Degree of Convergence of an Approximation Process

**3.9.2** Let  $x_1, x_2, x_3, \dots$  be an infinite sequence of approximations to a number  $\xi$ . Then, if

$$|x_{n+1} - \xi| < A |x_n - \xi|^k, \quad (n = 1, 2, \dots)$$

where  $A$  and  $k$  are independent of  $n$ , the sequence is said to have convergence of at most the  $k$ th degree (or order or index) to  $\xi$ . If  $k = 1$  and  $A < 1$  the convergence is linear; if  $k = 2$  the convergence is quadratic.

#### Regula Falsi (False Position)

**3.9.3** Given  $y = f(x)$  to find  $\xi$  such that  $f(\xi) = 0$ , choose  $x_0$  and  $x_1$  such that  $f(x_0)$  and  $f(x_1)$  have opposite signs and compute

$$x_2 = x_1 - \frac{(x_1 - x_0)}{(f_1 - f_0)} f_1 = \frac{f_1 x_0 - f_0 x_1}{f_1 - f_0}.$$

Then continue with  $x_2$  and either of  $x_0$  or  $x_1$  for which  $f(x_0)$  or  $f(x_1)$  is of opposite sign to  $f(x_2)$ .

Regula falsi is equivalent to inverse linear interpolation.

#### Method of Iteration (Successive Substitution)

**3.9.4** The iteration scheme  $x_{k+1} = F(x_k)$  will converge to a zero of  $x = F(x)$  if

$$(1) \quad |F'(x)| \leq q < 1 \text{ for } a \leq x \leq b,$$

$$(2) \quad a \leq x_0 \pm \frac{|F(x_0) - x_0|}{1 - q} \leq b.$$

#### Newton's Method of Successive Approximations

### 3.9.5

#### Newton's Rule

If  $x = x_k$  is an approximation to the solution  $x = \xi$  of  $f(x) = 0$  then the sequence

$$x_{k+1} = x_k - \frac{f(x_k)}{f'(x_k)}$$

will converge quadratically to  $x = \xi$ : (if instead of the condition (2) above),

(1) *Monotonic convergence*,  $f(x_0)f''(x_0) > 0$  and  $f'(x), f''(x)$  do not change sign in the interval  $(x_0, \xi)$ , or

(2) *Oscillatory convergence*,  $f(x_0)f''(x_0) < 0$  and  $f'(x), f''(x)$  do not change sign in the interval  $(x_0, x_1)$ ,  $x_0 \leq \xi \leq x_1$ .

#### Newton's Method Applied to Real $n$ th Roots

**3.9.6** Given  $x^n = N$ , if  $x_k$  is an approximation  $x = N^{1/n}$  then the sequence

$$x_{k+1} = \frac{1}{n} \left[ \frac{N}{x_k^{n-1}} + (n-1)x_k \right]$$

will converge quadratically to  $x$ .

$$\text{If } n = 2, x_{k+1} = \frac{1}{2} \left( \frac{N}{x_k} + x_k \right),$$

$$\text{If } n = 3, x_{k+1} = \frac{1}{3} \left( \frac{N}{x_k^2} + 2x_k \right).$$

#### Aitken's $\delta^2$ -Process for Acceleration of Sequences

**3.9.7** If  $x_k, x_{k+1}, x_{k+2}$  are three successive iterates in a sequence converging with an error which is approximately in geometric progression, then

$$\bar{x}_k = x_k - \frac{(x_k - x_{k+1})^2}{\Delta^2 x_k} = \frac{x_k x_{k+2} - x_{k+1}^2}{\Delta^2 x_k},$$

$$\Delta^2 x_k = x_k - 2x_{k+1} + x_{k+2}$$

is an improved estimate of  $x$ . In fact, if  $x_k = x + O(\lambda^k)$  then  $\bar{x} = x + O(\lambda^k)$ ,  $|\lambda| < 1$ .

3.10. Theorems on Continued Fractions

Definitions

3.10.1

(1) Let 
$$f = b_0 + \frac{a_1}{b_1 + \frac{a_2}{b_2 + \frac{a_3}{b_3 + \dots}}}$$
  

$$= b_0 + \frac{a_1}{b_1 +} \frac{a_2}{b_2 +} \frac{a_3}{b_3 +} \dots$$

If the number of terms is finite,  $f$  is called a terminating continued fraction. If the number of terms is infinite,  $f$  is called an infinite continued fraction and the terminating fraction

$$f_n = \frac{A_n}{B_n} = b_0 + \frac{a_1}{b_1 +} \frac{a_2}{b_2 +} \dots \frac{a_n}{b_n}$$

is called the  $n$ th convergent of  $f$ .

(2) If  $\lim_{n \rightarrow \infty} \frac{A_n}{B_n}$  exists, the infinite continued fraction  $f$  is said to be convergent. If  $a_i = 1$  and the  $b_i$  are integers there is always convergence.

Theorems

(1) If  $a_i$  and  $b_i$  are positive then  $f_{2n} < f_{2n+2}$ ,  $f_{2n-1} > f_{2n+1}$ .

(2) If  $f_n = \frac{A_n}{B_n}$ ,

$$A_n = b_n A_{n-1} + a_n A_{n-2}$$

$$B_n = b_n B_{n-1} + a_n B_{n-2}$$

where  $A_{-1} = 1, A_0 = b_0, B_{-1} = 0, B_0 = 1$ .

(3) 
$$\begin{bmatrix} A_n \\ B_n \end{bmatrix} = \begin{bmatrix} A_{n-1} & A_{n-2} \\ B_{n-1} & B_{n-2} \end{bmatrix} \begin{bmatrix} b_n \\ a_n \end{bmatrix}$$

(4) 
$$A_n B_{n-1} - A_{n-1} B_n = (-1)^{n-1} \prod_{k=1}^n a_k$$

(5) For every  $n \geq 0$ ,

$$f_n = b_0 + \frac{c_1 a_1}{c_1 b_1 +} \frac{c_1 c_2 a_2}{c_2 b_2 +} \frac{c_2 c_3 a_3}{c_3 b_3 +} \dots \frac{c_{n-1} c_n a_n}{c_n b_n}$$

(6) 
$$1 + b_2 + b_2 b_3 + \dots + b_2 b_3 \dots b_n$$
  

$$= \frac{1}{1 -} \frac{b_2}{b_2 + 1 -} \frac{b_3}{b_3 + 1 -} \dots \frac{b_n}{b_n + 1}$$

$$\frac{1}{u_1} + \frac{1}{u_2} + \dots + \frac{1}{u_n} = \frac{1}{u_1 -} \frac{u_1^2}{u_1 + u_2 -} \dots \frac{u_{n-1}^2}{-u_{n-1} + u_n}$$

$$\frac{1}{a_0} \frac{x}{a_0 a_1} + \frac{x^2}{a_0 a_1 a_2} \dots + (-1)^n \frac{x^n}{a_0 a_1 a_2 \dots a_n}$$
  

$$= \frac{1}{a_0 +} \frac{a_0 x}{a_1 - x +} \frac{a_1 x}{a_2 - x +} \dots \frac{a_{n-1} x}{+ a_n - x}$$

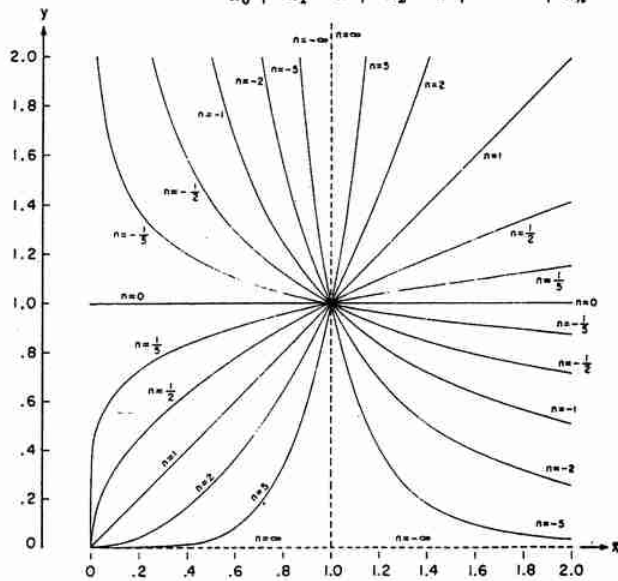

FIGURE 3.1.  $y = x^n$ .  
 $\pm n = 0, \frac{1}{5}, \frac{1}{2}, 1, 2, 5$ .

Numerical Methods

3.11. Use and Extension of the Tables

Example 1. Compute  $x^{19}$  and  $x^{47}$  for  $x=29$  using Table 3.1.

$$x^{19} = x^9 \cdot x^{10}$$
  

$$= (1.45071 \ 4598 \cdot 10^{13})(4.20707 \ 2333 \cdot 10^{14})$$
  

$$= 6.10326 \ 1248 \cdot 10^{27}$$

$$x^{47} = (x^{24})^2 / x$$
  

$$= (1.25184 \ 9008 \cdot 10^{35})^2 / 29$$
  

$$= 5.40388 \ 2547 \cdot 10^{68}$$

Example 2. Compute  $x^{-3/4}$  for  $x=9.19826$ .

$$(9.19826)^{1/4} = (919.826/100)^{1/4} = (919.826)^{1/4} / 10^{1/4}$$

Linear interpolation in Table 3.1 gives  $(919.826)^{1/4} \approx 5.507144$ .

By Newton's method for fourth roots with  $N=919.826$ ,

$$\frac{1}{4} \left[ \frac{919.826}{(5.507144)^3} + 3(5.507144) \right] = 5.50714 \ 3845$$

Repetition yields the same result. Thus,

$$x^{1/4} = 5.50714 \ 3845 / 10^{1/4} = 1.74151 \ 1796,$$
  

$$x^{-3/4} = x^1 / x = .18933 \ 05683.$$

3.12. Computing Techniques

Example 3. Solve the quadratic equation  $x^2 - 18.2x + .056$  given the coefficients as  $18.2 \pm .1$ ,

\*See page 11.

.056 ± .001. From 3.8.1 the solution is

$$\begin{aligned} x &= \frac{1}{2}(18.2 \pm [(18.2)^2 - 4(.056)]^{\frac{1}{2}}) \\ &= \frac{1}{2}(18.2 \pm [331.016]^{\frac{1}{2}}) = \frac{1}{2}(18.2 \pm 18.1939) \\ &= 18.1969, .003 \end{aligned}$$

The smaller root may be obtained more accurately from

$$* \quad .056/18.1969 = .0031 \pm .0001.$$

**Example 4.** Compute  $(-3 + .0076i)^{\frac{1}{2}}$ .

From 3.7.26,  $(-3 + .0076i)^{\frac{1}{2}} = u + iv$  where

$$u = \frac{y}{2v}, v = \left(\frac{r-x}{2}\right)^{\frac{1}{2}}, r = (x^2 + y^2)^{\frac{1}{2}}$$

Thus

$$r = [(-3)^2 + (.0076)^2]^{\frac{1}{2}} = (9.00005776)^{\frac{1}{2}} = 3.000009627$$

$$v = \left[ \frac{3.000009627 - (-3)}{2} \right]^{\frac{1}{2}} = 1.732052196$$

$$u = \frac{y}{2v} = \frac{.0076}{2(1.732052196)} = .00219392926$$

We note that the principal square root has been computed.

**Example 6.** Solve the quartic equation

$$\begin{aligned} x^4 - 2.377524922x^3 + 6.073505741x^2 \\ - 11.17938023x + 9.052655259 = 0. \end{aligned}$$

**Resolution Into Quadratic Factors**  
 $(x^2 + p_1x + q_1)(x^2 + p_2x + q_2)$   
 by Inverse Interpolation

Starting with the trial value  $q_1 = 1$  we compute successively

| $q_1$ | $q_2 = \frac{a_0}{q_1}$ | $p_1 = \frac{a_1 - a_2q_1}{q_2 - q_1}$ | $p_2 = a_3 - p_1$ | $y(q_1) = q_1 + q_2 + p_1p_2 - a_2$ |
|-------|-------------------------|--|-------------------|-------------------------------------|
| 1     | 9.053                   | -1.093                                 | -1.284            | 5.383                               |
| 2     | 4.526                   | -2.543                                 | .165              | .032                                |
| 2.2   | 4.115                   | -3.106                                 | .729              | -2.023                              |

| $q_1$  | $q_2$       | $p_1$       | $p_2$     | $y(q_1)$   |
|--------|-------------|-------------|-----------|------------|
| 2.0041 | 4.517067640 | -2.55259257 | .17506765 | .00078552  |
| 2.0042 | 4.516842260 | -2.55282851 | .17530358 | .00001655  |
| 2.0043 | 4.516616903 | -2.55306447 | .17553955 | -.00075263 |

Inverse interpolation gives  $q_1 = 2.004202152$ , and we get finally,

| $q_1$       | $q_2$       | $p_1$       | $p_2$      | $y(q_1)$   |
|-------------|-------------|-------------|------------|------------|
| 2.004202152 | 4.516837410 | -2.55283358 | .175308659 | -.00000011 |

**Example 5.** Solve the cubic equation  $x^3 - 18.1x - 34.8 = 0$ .

To use Newton's method we first form the table of  $f(x) = x^3 - 18.1x - 34.8$

| $x$ | $f(x)$ |
|-----|--------|
| 4   | -43.2  |
| 5   | -.3    |
| 6   | 72.6   |
| 7   | 181.5  |

We obtain by linear inverse interpolation:

$$x_0 = 5 + \frac{0 - (-0.3)}{72.6 - (-0.3)} = 5.004.$$

Using Newton's method,  $f'(x) = 3x^2 - 18.1$  we get

$$\begin{aligned} x_1 &\approx x_0 - f(x_0)/f'(x_0) \\ &\approx 5.004 - \frac{(-.072159936)}{57.020048} \approx 5.00526. \end{aligned}$$

Repetition yields  $x_1 = 5.005265097$ . Dividing  $f(x)$  by  $x - 5.005265097$  gives  $x^2 + 5.005265097x + 6.95267869$  the zeros of which are  $-2.502632549 \pm .83036800i$ .

We seek that value of  $q_1$  for which  $y(q_1) = 0$ . Inverse interpolation in  $y(q_1)$  gives  $y(q_1) \approx 0$  for  $q_1 \approx 2.003$ . Then,

| $q_1$ | $q_2$ | $p_1$  | $p_2$ | $y(q_1)$ |
|-------|-------|--------|-------|----------|
| 2.003 | 4.520 | -2.550 | .172  | .011     |

Inverse interpolation between  $q_1 = 2.2$  and  $q_1 = 2.003$  gives  $q_1 = 2.0041$ , and thus,

## References

## Texts

- [3.1] R. A. Buckingham, *Numerical methods* (Pitman Publishing Corp., New York, N.Y., 1957).
- [3.2] T. Fort, *Finite differences* (Clarendon Press, Oxford, England, 1948).
- [3.3] L. Fox, *The use and construction of mathematical tables*, *Mathematical Tables*, vol. 1, National Physical Laboratory (Her Majesty's Stationery Office, London, England, 1956).
- [3.4] G. H. Hardy, *A course of pure mathematics*, 9th ed. (Cambridge Univ. Press, Cambridge, England, and The Macmillan Co., New York, N.Y., 1947).
- [3.5] D. R. Hartree, *Numerical analysis* (Clarendon Press, Oxford, England, 1952).
- [3.6] F. B. Hildebrand, *Introduction to numerical analysis* (McGraw-Hill Book Co., Inc., New York, N.Y., 1956).
- [3.7] A. S. Householder, *Principles of numerical analysis* (McGraw-Hill Book Co., Inc., New York, N.Y., 1953).
- [3.8] L. V. Kantorowitsch and V. I. Krylow, *Näherungsmethoden der Höheren Analysis* (VEB Deutscher Verlag der Wissenschaften, Berlin, Germany, 1956; translated from Russian, Moscow, U.S.S.R., 1952).
- [3.9] K. Knopp, *Theory and application of infinite series* (Blackie and Son, Ltd., London, England, 1951).
- [3.10] Z. Kopal, *Numerical analysis* (John Wiley & Sons, Inc., New York, N.Y., 1955).
- [3.11] G. Kowalewski, *Interpolation und genäherte Quadratur* (B. G. Teubner, Leipzig, Germany, 1932).
- [3.12] K. S. Kunz, *Numerical analysis* (McGraw-Hill Book Co., Inc., New York, N.Y., 1957).
- [3.13] C. Lanczos, *Applied analysis* (Prentice-Hall, Inc., Englewood Cliffs, N.J., 1956).
- [3.14] I. M. Longman, *Note on a method for computing infinite integrals of oscillatory functions*, *Proc. Cambridge Philos. Soc.* **52**, 764 (1956).
- [3.15] S. E. Mikeladze, *Numerical methods of mathematical analysis* (Russian) (Gos. Izdat. Tehn.-Teor. Lit., Moscow, U.S.S.R., 1953).
- [3.16] W. E. Milne, *Numerical calculus* (Princeton Univ. Press, Princeton, N.J., 1949).
- [3.17] L. M. Milne-Thomson, *The calculus of finite differences* (Macmillan and Co., Ltd., London, England, 1951).
- [3.18] H. Mineur, *Techniques de calcul numérique* (Librairie Polytechnique Ch. Béranger, Paris, France, 1952).
- [3.19] National Physical Laboratory, *Modern computing methods*, *Notes on Applied Science No. 16* (Her Majesty's Stationery Office, London, England, 1957).
- [3.20] J. B. Rosser, *Transformations to speed the convergence of series*, *J. Research NBS* **46**, 56-64 (1951).
- [3.21] J. B. Scarborough, *Numerical mathematical analysis*, 3d ed. (The Johns Hopkins Press, Baltimore, Md.; Oxford Univ. Press, London, England, 1955).
- [3.22] J. F. Steffensen, *Interpolation* (Chelsea Publishing Co., New York, N.Y., 1950).
- [3.23] H. S. Wall, *Analytic theory of continued fractions* (D. Van Nostrand Co., Inc., New York, N.Y., 1948).
- [3.24] E. T. Whittaker and G. Robinson, *The calculus of observations*, 4th ed. (Blackie and Son, Ltd., London, England, 1944).
- [3.25] R. Zurmühl, *Praktische Mathematik* (Springer-Verlag, Berlin, Germany, 1953).

## Mathematical Tables and Collections of Formulas

- [3.26] E. P. Adams, *Smithsonian mathematical formulae and tables of elliptic functions*, 3d reprint (The Smithsonian Institution, Washington, D.C., 1957).
- [3.27] L. J. Comrie, *Barlow's tables of squares, cubes, square roots, cube roots and reciprocals of all integers up to 12,500* (Chemical Publishing Co., Inc., New York, N.Y., 1954).
- [3.28] H. B. Dwight, *Tables of integrals and other mathematical data*, 3d ed. (The Macmillan Co., New York, N.Y., 1957).
- [3.29] Gt. Britain H.M. Nautical Almanac Office, *Interpolation and allied tables* (Her Majesty's Stationery Office, London, England, 1956).
- [3.30] B. O. Peirce, *A short table of integrals*, 4th ed. (Ginn and Co., Boston, Mass., 1956).
- [3.31] G. Schulz, *Formelsammlung zur praktischen Mathematik* (de Gruyter and Co., Berlin, Germany, 1945).



# 4. Elementary Transcendental Functions

## Logarithmic, Exponential, Circular and Hyperbolic Functions

RUTH ZUCKER<sup>1</sup>

### Contents

|   | Page |
|---|------|
| <b>Mathematical Properties</b> . . . . .  | 67   |
| 4.1. Logarithmic Function . . . . .   | 67   |
| 4.2. Exponential Function . . . . .   | 69   |
| 4.3. Circular Functions . . . . .   | 71   |
| 4.4. Inverse Circular Functions . . . . .   | 79   |
| 4.5. Hyperbolic Functions . . . . .   | 83   |
| 4.6. Inverse Hyperbolic Functions . . . . .   | 86   |
| <b>Numerical Methods</b> . . . . .  | 89   |
| 4.7. Use and Extension of the Tables . . . . .  | 89   |
| <b>References</b> . . . . .   | 93   |
| <b>Table 4.1.</b> Common Logarithms ( $100 \leq x \leq 1350$ ) . . . . .                                      | 95   |
| $\log_{10} x$ , $x=100(1)1350$ , 10D  |      |
| <b>Table 4.2.</b> Natural Logarithms ( $0 \leq x \leq 2.1$ ) . . . . .  | 100  |
| $\ln x$ , $x=0(.001)2.1$ , 16D  |      |
| <b>Table 4.3.</b> Radix Table of Natural Logarithms . . . . .   | 114  |
| $\ln(1+x)$ , $-\ln(1-x)$ , $x=10^{-n}(10^{-n})10^{-n+1}$ , $n=10(-1)1$ , 25D                                  |      |
| <b>Table 4.4.</b> Exponential Function ( $0 \leq  x  \leq 100$ ) . . . . .                                    | 116  |
| $e^x$ , $\pm x=0(.001)1$ , 18D, $x=0(.1)5$ , 15D  |      |
| $x=5(.1)10$ , 12D, $-x=0(.1)10$ , 20D   |      |
| $\pm x=0(1)100$ , 19S   |      |
| <b>Table 4.5.</b> Radix Table of the Exponential Function . . . . .   | 140  |
| $e^x, e^{-x}$ , $x=10^{-n}(10^{-n})10^{-n+1}$ , $n=10(-1)1$ , 25D   |      |
| <b>Table 4.6.</b> Circular Sines and Cosines for Radian Arguments ( $0 \leq x \leq 1.6$ ) . . . . .           | 142  |
| $\sin x, \cos x$ , $x=0(.001)1.6$ , 23D   |      |
| <b>Table 4.7.</b> Radix Table of Circular Sines and Cosines . . . . .   | 174  |
| $\sin x, \cos x$ , $x=10^{-n}(10^{-n})10^{-n+1}$ , $n=10(-1)4$ , 25D  |      |
| <b>Table 4.8.</b> Circular Sines and Cosines for Large Radian Arguments<br>( $0 \leq x \leq 1000$ ) . . . . . | 175  |
| $\sin x, \cos x$ , $x=0(1)100$ , 23D, $x=100(1)1000$ , 8D   |      |

---

<sup>1</sup> National Bureau of Standards.



## 4. Elementary Transcendental Functions

# Logarithmic, Exponential, Circular and Hyperbolic Functions

### Mathematical Properties

#### 4.1. Logarithmic Function

##### Integral Representation

$$4.1.1 \quad \ln z = \int_1^z \frac{dt}{t}$$

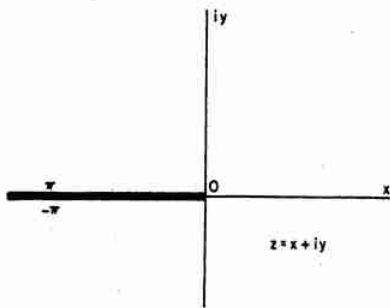

FIGURE 4.1. Branch cut for  $\ln z$  and  $z^a$ .  
( $a$  not an integer or zero.)

where the path of integration does not pass through the origin or cross the negative real axis.  $\ln z$  is a single-valued function, regular in the  $z$ -plane cut along the negative real axis, real when  $z$  is positive.

$$z = x + iy = re^{i\theta}$$

$$4.1.2 \quad \ln z = \ln r + i\theta \quad (-\pi < \theta \leq \pi)$$

$$4.1.3 \quad r = (x^2 + y^2)^{1/2}, \quad x = r \cos \theta, \quad y = r \sin \theta,$$

$$\theta = \arctan \frac{y}{x}$$

The general logarithmic function is the many-valued function  $\text{Ln } z$  defined by

$$4.1.4 \quad \text{Ln } z = \int_1^z \frac{dt}{t}$$

where the path does not pass through the origin.

$$4.1.5 \quad \text{Ln}(re^{i\theta}) = \ln(re^{i\theta}) + 2k\pi i = \ln r + i(\theta + 2k\pi),$$

$k$  being an arbitrary integer.  $\ln z$  is said to be the *principal branch* of  $\text{Ln } z$ .

##### Logarithmic Identities

$$4.1.6 \quad \text{Ln}(z_1 z_2) = \text{Ln } z_1 + \text{Ln } z_2$$

(i.e., every value of  $\text{Ln}(z_1 z_2)$  is one of the values of  $\text{Ln } z_1 + \text{Ln } z_2$ .)

$$4.1.7 \quad \ln(z_1 z_2) = \ln z_1 + \ln z_2$$

$$(-\pi < \arg z_1 + \arg z_2 \leq \pi)$$

$$4.1.8 \quad \text{Ln} \frac{z_1}{z_2} = \text{Ln } z_1 - \text{Ln } z_2$$

$$4.1.9 \quad \ln \frac{z_1}{z_2} = \ln z_1 - \ln z_2$$

$$(-\pi < \arg z_1 - \arg z_2 \leq \pi)$$

$$4.1.10 \quad \text{Ln } z^n = n \text{Ln } z \quad (n \text{ integer})$$

$$4.1.11 \quad \ln z^n = n \ln z$$

$$(n \text{ integer}, \quad -\pi < n \arg z \leq \pi)$$

##### Special Values (see chapter 1)

$$4.1.12 \quad \ln 1 = 0$$

$$4.1.13 \quad \ln 0 = -\infty$$

$$4.1.14 \quad \ln(-1) = \pi i$$

$$4.1.15 \quad \ln(\pm i) = \pm \frac{1}{2}\pi i$$

$$4.1.16 \quad \ln e = 1, \quad e \text{ is the real number such that}$$

$$\int_1^e \frac{dt}{t} = 1$$

$$4.1.17 \quad e = \lim_{n \rightarrow \infty} \left(1 + \frac{1}{n}\right)^n = 2.71828 \ 18284 \dots$$

(see 4.2.21)

##### Logarithms to General Base

$$4.1.18 \quad \log_a z = \ln z / \ln a$$

$$4.1.19 \quad \log_a z = \frac{\log_b z}{\log_b a}$$

$$4.1.20 \quad \log_a b = \frac{1}{\log_b a}$$

$$4.1.21 \quad \log_e z = \ln z$$

$$4.1.22 \quad \log_{10} z = \ln z / \ln 10 = \log_{10} e \ln z$$

$$= (.43429 \ 44819 \dots) \ln z$$



$$4.1.23 \quad \ln z = \ln 10 \log_{10} z = (2.30258 \ 50929 \dots) \log_{10} z$$

( $\log_e x = \ln x$ , called natural, Napierian, or hyperbolic logarithms;  $\log_{10} x$ , called common or Briggs logarithms.)

#### Series Expansions

$$4.1.24 \quad \ln(1+z) = z - \frac{1}{2}z^2 + \frac{1}{3}z^3 - \dots$$

$$(|z| \leq 1 \text{ and } z \neq -1)$$

$$4.1.25 \quad \ln z = \left(\frac{z-1}{z}\right) + \frac{1}{2}\left(\frac{z-1}{z}\right)^2 + \frac{1}{3}\left(\frac{z-1}{z}\right)^3 + \dots$$

$$(\Re z \geq \frac{1}{2})$$

$$4.1.26 \quad \ln z = (z-1) - \frac{1}{2}(z-1)^2 + \frac{1}{3}(z-1)^3 - \dots$$

$$(|z-1| \leq 1, \ z \neq 0)$$

$$4.1.27 \quad \ln z = 2 \left[ \left(\frac{z-1}{z+1}\right) + \frac{1}{3}\left(\frac{z-1}{z+1}\right)^3 + \frac{1}{5}\left(\frac{z-1}{z+1}\right)^5 + \dots \right]$$

$$(\Re z \geq 0, \ z \neq 0)$$

$$4.1.28 \quad \ln\left(\frac{z+1}{z-1}\right) = 2 \left( \frac{1}{z} + \frac{1}{3z^3} + \frac{1}{5z^5} + \dots \right)$$

$$(|z| \geq 1, \ z \neq \pm 1)$$

$$4.1.29 \quad \ln(z+a) = \ln a + 2 \left[ \left(\frac{z}{2a+z}\right) + \frac{1}{3}\left(\frac{z}{2a+z}\right)^3 + \frac{1}{5}\left(\frac{z}{2a+z}\right)^5 + \dots \right]$$

$$(a > 0, \ \Re z \geq -a \neq z)$$

#### Limiting Values

$$4.1.30 \quad \lim_{x \rightarrow \infty} x^{-\alpha} \ln x = 0$$

$$(\alpha \text{ constant, } \Re \alpha > 0)$$

$$4.1.31 \quad \lim_{x \rightarrow 0} x^\alpha \ln x = 0$$

$$(\alpha \text{ constant, } \Re \alpha > 0)$$

$$4.1.32 \quad \lim_{m \rightarrow \infty} \left( \sum_{k=1}^m \frac{1}{k} - \ln m \right) = \gamma \text{ (Euler's constant)}$$

$$= .57721 \ 56649 \dots$$

$$\text{(see chapters 1, 6 and 23)}$$

#### Inequalities

$$4.1.33 \quad \frac{x}{1+x} < \ln(1+x) < x$$

$$(x > -1, \ x \neq 0)$$

$$4.1.34 \quad x < -\ln(1-x) < \frac{x}{1-x}$$

$$(x < 1, \ x \neq 0)$$

$$4.1.35 \quad |\ln(1-x)| < \frac{3x}{2} \quad (0 < x \leq .5828)$$

$$4.1.36 \quad \ln x \leq x-1 \quad (x > 0)$$

$$4.1.37 \quad \ln x \leq n(x^{1/n}-1) \text{ for any positive } n$$

$$(x > 0)$$

$$4.1.38 \quad |\ln(1+z)| \leq -\ln(1-|z|) \quad (|z| < 1)$$

#### Continued Fractions

$$4.1.39 \quad \ln(1+z) = \frac{z}{1 + \frac{z}{2 + \frac{z}{3 + \frac{4z}{4 + \frac{4z}{5 + \frac{9z}{6 + \dots}}}}}}$$

$$(z \text{ in the plane cut from } -1 \text{ to } -\infty)$$

$$4.1.40 \quad \ln\left(\frac{1+z}{1-z}\right) = \frac{2z}{1-3-\frac{z^2}{5-\frac{4z^2}{7-\dots}}}$$

$$(z \text{ in the cut plane of Figure 4.7.})$$

#### Polynomial Approximations<sup>2</sup>

$$4.1.41 \quad \frac{1}{\sqrt{10}} \leq x \leq \sqrt{10}$$

$$\log_{10} x = a_1 t + a_3 t^3 + \epsilon(x), \quad t = (x-1)/(x+1)$$

$$|\epsilon(x)| \leq 6 \times 10^{-4}$$

$$a_1 = .86304 \quad a_3 = .36415$$

$$4.1.42 \quad \frac{1}{\sqrt{10}} \leq x \leq \sqrt{10}$$

$$\log_{10} x = a_1 t + a_3 t^3 + a_5 t^5 + a_7 t^7 + a_9 t^9 + \epsilon(x)$$

$$t = (x-1)/(x+1)$$

$$|\epsilon(x)| \leq 10^{-7}$$

$$a_1 = .86859 \ 1718 \quad a_7 = .09437 \ 6476$$

$$a_3 = .28933 \ 5524 \quad a_9 = .19133 \ 7714$$

$$a_5 = .17752 \ 2071$$

$$4.1.43 \quad 0 \leq x \leq 1$$

$$\ln(1+x) = a_1 x + a_2 x^2 + a_3 x^3 + a_4 x^4 + a_5 x^5 + \epsilon(x)$$

$$|\epsilon(x)| \leq 1 \times 10^{-5}$$

$$a_1 = .99949 \ 556 \quad a_4 = -.13606 \ 275$$

$$a_2 = -.49190 \ 896 \quad a_5 = .03215 \ 845$$

$$a_3 = .28947 \ 478$$

<sup>2</sup> The approximations 4.1.41 to 4.1.44 are from C. Hastings, Jr., Approximations for digital computers. Princeton Univ. Press, Princeton, N.J., 1955 (with permission).

**4.1.44**  $0 \leq x \leq 1$   
 $\ln(1+x) = a_1x + a_2x^2 + a_3x^3 + a_4x^4 + a_5x^5 + a_6x^6$   
 $+ a_7x^7 + a_8x^8 + \epsilon(x)$

$|\epsilon(x)| \leq 3 \times 10^{-8}$

|                        |                        |
|------------------------|------------------------|
| $a_1 = .99999\ 64239$  | $a_5 = .16765\ 40711$  |
| $a_2 = -.49987\ 41238$ | $a_6 = -.09532\ 93897$ |
| $a_3 = .33179\ 90258$  | $a_7 = .03608\ 84937$  |
| $a_4 = -.24073\ 38084$ | $a_8 = -.00645\ 35442$ |

**Approximation in Terms of Chebyshev Polynomials<sup>3</sup>**

**4.1.45**  $0 \leq x \leq 1$   
 $T_n^*(x) = \cos n\theta, \cos \theta = 2x - 1$  (see chapter 22)

$\ln(1+x) = \sum_{n=0}^{\infty} A_n T_n^*(x)$

| $n$ | $A_n$        | $n$ | $A_n$        |
|-----|--------------|-----|--------------|
| 0   | .37645 2813  | 6   | -.00000 8503 |
| 1   | .34314 5750  | 7   | .00000 1250  |
| 2   | -.02943 7252 | 8   | -.00000 0188 |
| 3   | .00336 7089  | 9   | .00000 0029  |
| 4   | -.00043 3276 | 10  | -.00000 0004 |
| 5   | .00005 9471  | 11  | .00000 0001  |

**Differentiation Formulas**

**4.1.46**  $\frac{d}{dz} \ln z = \frac{1}{z}$

**4.1.47**  $\frac{d^n}{dz^n} \ln z = (-1)^{n-1} (n-1)! z^{-n}$

**Integration Formulas**

**4.1.48**  $\int \frac{dz}{z} = \ln z$

**4.1.49**  $\int \ln z \, dz = z \ln z - z$

**4.1.50**  $\int z^n \ln z \, dz = \frac{z^{n+1}}{n+1} \ln z - \frac{z^{n+1}}{(n+1)^2}$   
 $(n \neq -1, n \text{ integer})$

**4.1.51**  $\int z^n (\ln z)^m \, dz = \frac{z^{n+1} (\ln z)^m}{n+1} - \frac{m}{n+1} \int z^n (\ln z)^{m-1} \, dz$   
 $(n \neq -1)$

<sup>3</sup> The approximation 4.1.45 is from C. W. Clenshaw, Polynomial approximations to elementary functions, Math. Tables Aids Comp. 8, 143-147 (1954) (with permission).

**4.1.52**  $\int \frac{dz}{z \ln z} = \ln \ln z$

**4.1.53**  $\int \ln [z + (z^2 \pm 1)^{\frac{1}{2}}] \, dz = z \ln [z + (z^2 \pm 1)^{\frac{1}{2}}] - (z^2 \pm 1)^{\frac{1}{2}}$

**4.1.54**  $\int z^n \ln [z + (z^2 \pm 1)^{\frac{1}{2}}] \, dz = \frac{z^{n+1}}{n+1} \ln [z + (z^2 \pm 1)^{\frac{1}{2}}]$   
 $- \frac{1}{n+1} \int \frac{z^{n+1}}{(z^2 \pm 1)^{\frac{1}{2}}} \, dz \quad (n \neq -1)$

**Definite Integrals**

**4.1.55**  $\int_0^1 \frac{\ln t}{1-t} \, dt = -\pi^2/6$

**4.1.56**  $\int_0^1 \frac{\ln t}{1+t} \, dt = -\pi^2/12$

**4.1.57**  $\int_0^x \frac{dt}{\ln t} = li(x)$  (see 5.1.3)

**4.2. Exponential Function**

**Series Expansion**

**4.2.1**  $e^z = \exp z = 1 + \frac{z}{1!} + \frac{z^2}{2!} + \frac{z^3}{3!} + \dots \quad (z = x + iy)$

where  $e$  is the real number defined in 4.1.16

**Fundamental Properties**

**4.2.2**  $\text{Ln}(\exp z) = z + 2k\pi i \quad (k \text{ any integer})$

**4.2.3**  $\ln(\exp z) = z \quad (-\pi < \Im z \leq \pi)$

**4.2.4**  $\exp(\ln z) = \exp(\text{Ln } z) = z$

**4.2.5**  $\frac{d}{dz} \exp z = \exp z$

**Definition of General Powers**

**4.2.6** If  $N = a^z$ , then  $z = \text{Log}_a N$

**4.2.7**  $a^z = \exp(z \ln a)$

**4.2.8** If  $a = |a| \exp(i \arg a) \quad (-\pi < \arg a \leq \pi)$

**4.2.9**  $|a^z| = |a|^x e^{-y \arg a}$

**4.2.10**  $\arg(a^z) = y \ln |a| + x \arg a$

**4.2.11**  $\text{Ln } a^z = z \ln a$  for one of the values of  $\text{Ln } a^z$

**4.2.12**  $\ln a^x = x \ln a \quad (a \text{ real and positive})$

**4.2.13**  $|e^z| = e^x$

4.2.14  $\arg(e^z) = y$

4.2.15  $a^{z_1} a^{z_2} = a^{z_1+z_2}$

4.2.16  $a^z b^z = (ab)^z \quad (-\pi < \arg a + \arg b \leq \pi)$

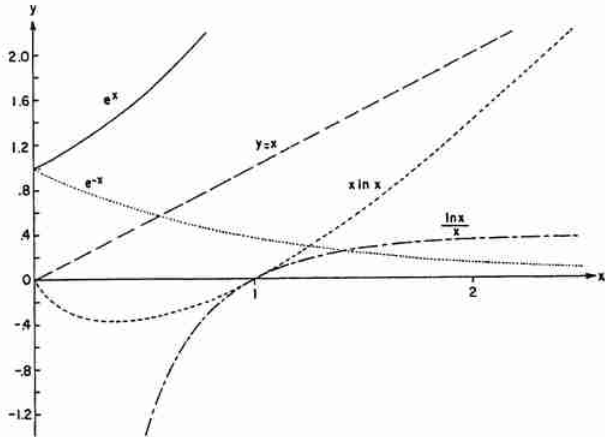
FIGURE 4.2. *Logarithmic and exponential functions.***Periodic Property**

4.2.17  $e^{z+2\pi ki} = e^z \quad (k \text{ any integer})$

**Exponential Identities**

4.2.18  $e^{z_1} e^{z_2} = e^{z_1+z_2}$

4.2.19  $(e^{z_1})^{z_2} = e^{z_1 z_2} \quad (-\pi < \mathcal{I} z_1 \leq \pi)$

The restriction  $(-\pi < \mathcal{I} z_1 \leq \pi)$  can be removed if  $z_2$  is an integer.

**Limiting Values**

4.2.20  $\lim_{|z| \rightarrow \infty} z^\alpha e^{-z} = 0 \quad (|\arg z| \leq \frac{1}{2}\pi - \epsilon < \frac{1}{2}\pi, \alpha \text{ constant})$

4.2.21  $\lim_{m \rightarrow \infty} \left(1 + \frac{z}{m}\right)^m = e^z$

**Special Values (see chapter 1)**

4.2.22  $e = 2.71828 \ 18284 \dots$

4.2.23  $e^0 = 1$

4.2.24  $e^\infty = \infty$

4.2.25  $e^{-\infty} = 0$

4.2.26  $e^{\pm \pi i} = -1$

4.2.27  $e^{\pm \frac{\pi i}{2}} = \pm i$

4.2.28  $e^{2\pi ki} = 1 \quad (k \text{ any integer})$

**Exponential Inequalities**

If  $x$  is real and different from zero

4.2.29  $e^{-\frac{x}{1-x}} < 1-x < e^{-x} \quad (x < 1)$

4.2.30  $e^x > 1+x$

4.2.31  $e^x < \frac{1}{1-x} \quad (x < 1)$

4.2.32  $\frac{x}{1+x} < (1-e^{-x}) < x \quad (x > -1)$

4.2.33  $x < (e^x - 1) < \frac{x}{1-x} \quad (x < 1)$

4.2.34  $1+x > e^{\frac{x}{1+x}} \quad (x > -1)$

4.2.35  $e^x > 1 + \frac{x^n}{n!} \quad (n > 0, x > 0)$

4.2.36  $e^x > \left(1 + \frac{x}{y}\right)^y > e^{\frac{xy}{x+y}} \quad (x > 0, y > 0)$

4.2.37  $e^{-x} < 1 - \frac{x}{2} \quad (0 < x \leq 1.5936)$

4.2.38  $\frac{1}{4}|z| < |e^z - 1| < \frac{7}{4}|z| \quad (0 < |z| < 1)$

4.2.39  $|e^z - 1| \leq e^{|z|} - 1 \leq |z| e^{|z|} \quad (\text{all } z)$

**Continued Fractions**

4.2.40  $e^z = \frac{1}{1 - \frac{z}{1 + \frac{z}{2 - \frac{z}{3 + \frac{z}{2 - \frac{z}{5 + \frac{z}{2 - \dots}}}}}}}} \quad (|z| < \infty)$

$$= 1 + \frac{z}{1 - \frac{z}{2 + \frac{z}{3 - \frac{z}{2 + \frac{z}{5 - \frac{z}{2 + \frac{z}{7 - \dots}}}}}}}} \quad (|z| < \infty)$$

$$= 1 + \frac{z}{(1-z/2) + \frac{z^2/4 \cdot 3}{1 + \frac{z^2/4 \cdot 15}{1 + \frac{z^2/4 \cdot 35}{1 + \dots \frac{z^2/4(4n^2-1)}{1 + \dots}}}} \quad (|z| < \infty)$$

4.2.41  $e^z - e_{n-1}(z) = \frac{z^n}{n! - (n+1)z} + \frac{z}{(n+2) - (n+3)z} + \frac{2z}{(n+4) - (n+5)z} + \frac{(n+2)z}{(n+6) - \dots} \quad (|z| < \infty)$

(For  $e_n(z)$  see 6.5.11)

4.2.42

$$e^{2a \arctan \frac{1}{z}} = 1 + \frac{2a}{z-a} + \frac{a^2+1}{3z+a} + \frac{a^2+4}{5z+a} + \frac{a^2+9}{7z+a} + \dots$$

( $z$  in the cut plane of Figure 4.4.)

Polynomial Approximations<sup>4</sup>

4.2.43  $0 \leq x \leq \ln 2 = .693 \dots$

$$e^{-x} = 1 + a_1x + a_2x^2 + \epsilon(x)$$

$$|\epsilon(x)| \leq 3 \times 10^{-3}$$

$$a_1 = -.9664 \quad a_2 = .3536$$

4.2.44  $0 \leq x \leq \ln 2$

$$e^{-x} = 1 + a_1x + a_2x^2 + a_3x^3 + a_4x^4 + \epsilon(x)$$

$$|\epsilon(x)| \leq 3 \times 10^{-5}$$

$$a_1 = -.99986 \ 84 \quad a_3 = -.15953 \ 32$$

$$a_2 = .49829 \ 26 \quad a_4 = .02936 \ 41$$

4.2.45  $0 \leq x \leq \ln 2$

$$e^{-x} = 1 + a_1x + a_2x^2 + a_3x^3 + a_4x^4 + a_5x^5 + a_6x^6 + a_7x^7 + \epsilon(x)$$

$$|\epsilon(x)| \leq 2 \times 10^{-10}$$

$$a_1 = -.99999 \ 99995 \quad a_5 = -.00830 \ 13598$$

$$a_2 = .49999 \ 99206 \quad a_6 = .00132 \ 98820$$

$$a_3 = -.16666 \ 53019 \quad a_7 = -.00014 \ 13161$$

$$a_4 = .04165 \ 73475$$

4.2.46<sup>5</sup>  $0 \leq x \leq 1$

$$10^x = (1 + a_1x + a_2x^2 + a_3x^3 + a_4x^4)^2 + \epsilon(x)$$

$$|\epsilon(x)| \leq 7 \times 10^{-4}$$

$$a_1 = 1.14991 \ 96 \quad a_3 = .20800 \ 30$$

$$a_2 = .67743 \ 23 \quad a_4 = .12680 \ 89$$

4.2.47  $0 \leq x \leq 1$

$$10^x = (1 + a_1x + a_2x^2 + a_3x^3 + a_4x^4 + a_5x^5 + a_6x^6 + a_7x^7)^2 + \epsilon(x)$$

$$|\epsilon(x)| < 5 \times 10^{-8}$$

$$a_1 = 1.15129 \ 277603 \quad a_5 = .01742 \ 111988$$

$$a_2 = .66273 \ 088429 \quad a_6 = .00255 \ 491796$$

$$a_3 = .25439 \ 357484 \quad a_7 = .00093 \ 264267$$

$$a_4 = .07295 \ 173666$$

<sup>4</sup> The approximations 4.2.43 to 4.2.45 are from B. Carlson, M. Goldstein, Rational approximation of functions, Los Alamos Scientific Laboratory LA-1943, Los Alamos, N. Mex., 1955 (with permission).

<sup>5</sup> The approximations 4.2.46 to 4.2.47 are from C. Hastings, Jr., Approximations for digital computers. Princeton Univ. Press, Princeton, N.J., 1955 (with permission).

Approximations in Terms of Chebyshev Polynomials<sup>6</sup>

4.2.48  $0 \leq x \leq 1$

$$T_n^*(x) = \cos n\theta, \quad \cos \theta = 2x - 1 \quad (\text{see chapter 22})$$

$$e^x = \sum_{n=0}^{\infty} A_n T_n^*(x) \quad e^{-x} = \sum_{n=0}^{\infty} A_n T_n^*(x)$$

| $n$ | $A_n$        | $n$ | $A_n$        |
|-----|--------------|-----|--------------|
| 0   | 1.75338 7654 | 0   | .64503 5270  |
| 1   | .85039 1654  | 1   | -.31284 1606 |
| 2   | .10520 8694  | 2   | .03870 4116  |
| 3   | .00872 2105  | 3   | -.00320 8683 |
| 4   | .00054 3437  | 4   | .00019 9919  |
| 5   | .00002 7115  | 5   | -.00000 9975 |
| 6   | .00000 1128  | 6   | .00000 0415  |
| 7   | .00000 0040  | 7   | -.00000 0015 |
| 8   | .00000 0001  |     |              |

Differentiation Formulas

4.2.49  $\frac{d}{dz} e^z = e^z$

4.2.50  $\frac{d^n}{dz^n} e^{az} = a^n e^{az}$

4.2.51  $\frac{d}{dz} a^z = a^z \ln a$

4.2.52  $\frac{d}{dz} z^a = a z^{a-1}$

4.2.53  $\frac{d}{dz} z^z = (1 + \ln z) z^z$

Integration Formulas

4.2.54  $\int e^{az} dz = e^{az}/a$

4.2.55  $\int z^n e^{az} dz = \frac{e^{az}}{a^{n+1}} [(az)^n - n(az)^{n-1} + n(n-1)(az)^{n-2} + \dots + (-1)^{n-1} n!(az) + (-1)^n n!]$  ( $n \geq 0$ )

4.2.56  $\int \frac{e^{az}}{z^n} dz = -\frac{e^{az}}{(n-1)z^{n-1}} + \frac{a}{n-1} \int \frac{e^{az}}{z^{n-1}} dz$  ( $n > 1$ )

(See chapters 5, 7 and 29 for other integrals involving exponential functions.)

4.3. Circular Functions

Definitions

4.3.1  $\sin z = \frac{e^{iz} - e^{-iz}}{2i}$  ( $z = x + iy$ )

4.3.2  $\cos z = \frac{e^{iz} + e^{-iz}}{2}$

<sup>6</sup> The approximations 4.2.48 are from C. W. Clenshaw, Polynomial approximations to elementary functions, Math. Tables Aids Comp. 8, 143-147 (1954) (with permission).

$$4.3.3 \quad \tan z = \frac{\sin z}{\cos z}$$

$$4.3.4 \quad \csc z = \frac{1}{\sin z}$$

$$4.3.5 \quad \sec z = \frac{1}{\cos z}$$

$$4.3.6 \quad \cot z = \frac{1}{\tan z}$$

**Periodic Properties**

$$4.3.7 \quad \sin(z + 2k\pi) = \sin z \quad (k \text{ any integer})$$

$$4.3.8 \quad \cos(z + 2k\pi) = \cos z$$

$$4.3.9 \quad \tan(z + k\pi) = \tan z$$

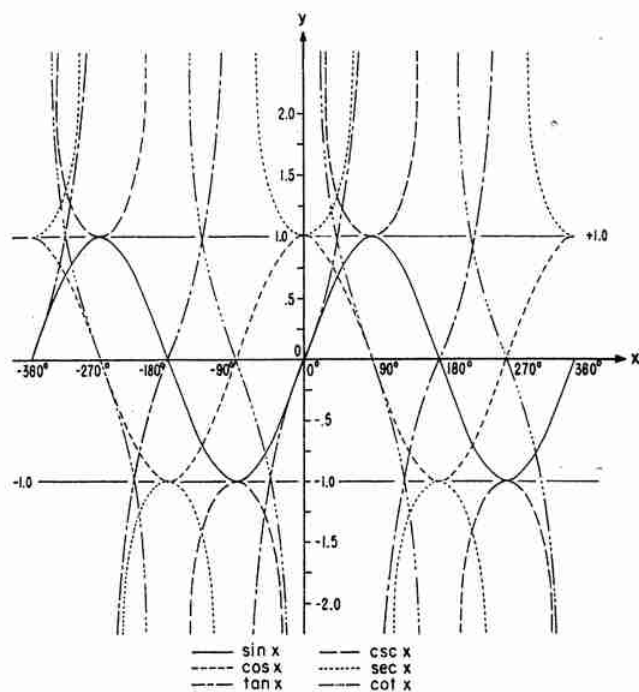
FIGURE 4.3. *Circular functions.***Relations Between Circular Functions**

$$4.3.10 \quad \sin^2 z + \cos^2 z = 1$$

$$4.3.11 \quad \sec^2 z - \tan^2 z = 1$$

$$4.3.12 \quad \csc^2 z - \cot^2 z = 1$$

**Negative Angle Formulas**

$$4.3.13 \quad \sin(-z) = -\sin z$$

$$4.3.14 \quad \cos(-z) = \cos z$$

$$4.3.15 \quad \tan(-z) = -\tan z$$

**Addition Formulas**

$$4.3.16 \quad \sin(z_1 + z_2) = \sin z_1 \cos z_2 + \cos z_1 \sin z_2$$

$$4.3.17 \quad \cos(z_1 + z_2) = \cos z_1 \cos z_2 - \sin z_1 \sin z_2$$

$$4.3.18 \quad \tan(z_1 + z_2) = \frac{\tan z_1 + \tan z_2}{1 - \tan z_1 \tan z_2}$$

$$4.3.19 \quad \cot(z_1 + z_2) = \frac{\cot z_1 \cot z_2 - 1}{\cot z_2 + \cot z_1}$$

**Half-Angle Formulas**

$$4.3.20 \quad \sin \frac{z}{2} = \pm \left( \frac{1 - \cos z}{2} \right)^{\frac{1}{2}}$$

$$4.3.21 \quad \cos \frac{z}{2} = \pm \left( \frac{1 + \cos z}{2} \right)^{\frac{1}{2}}$$

$$4.3.22 \quad \tan \frac{z}{2} = \pm \left( \frac{1 - \cos z}{1 + \cos z} \right)^{\frac{1}{2}} = \frac{1 - \cos z}{\sin z} = \frac{\sin z}{1 + \cos z}$$

The ambiguity in sign may be resolved with the aid of a diagram.

**Transformation of Trigonometric Integrals**

If  $\tan \frac{u}{2} = z$  then

$$4.3.23 \quad \sin u = \frac{2z}{1+z^2}, \quad \cos u = \frac{1-z^2}{1+z^2}, \quad du = \frac{2}{1+z^2} dz$$

**Multiple-Angle Formulas**

$$4.3.24 \quad \sin 2z = 2 \sin z \cos z = \frac{2 \tan z}{1 + \tan^2 z}$$

$$4.3.25 \quad \begin{aligned} \cos 2z &= 2 \cos^2 z - 1 = 1 - 2 \sin^2 z \\ &= \cos^2 z - \sin^2 z = \frac{1 - \tan^2 z}{1 + \tan^2 z} \end{aligned}$$

$$4.3.26 \quad \tan 2z = \frac{2 \tan z}{1 - \tan^2 z} = \frac{2 \cot z}{\cot^2 z - 1} = \frac{2}{\cot z - \tan z}$$

$$4.3.27 \quad \sin 3z = 3 \sin z - 4 \sin^3 z$$

$$4.3.28 \quad \cos 3z = -3 \cos z + 4 \cos^3 z$$

$$4.3.29 \quad \sin 4z = 8 \cos^3 z \sin z - 4 \cos z \sin z$$

$$4.3.30 \quad \cos 4z = 8 \cos^4 z - 8 \cos^2 z + 1$$

**Products of Sines and Cosines**

$$4.3.31 \quad 2 \sin z_1 \sin z_2 = \cos(z_1 - z_2) - \cos(z_1 + z_2)$$

$$4.3.32 \quad 2 \cos z_1 \cos z_2 = \cos(z_1 - z_2) + \cos(z_1 + z_2)$$

$$4.3.33 \quad 2 \sin z_1 \cos z_2 = \sin(z_1 - z_2) + \sin(z_1 + z_2)$$

**Addition and Subtraction of Two Circular Functions****4.3.34**

$$\sin z_1 + \sin z_2 = 2 \sin \left( \frac{z_1 + z_2}{2} \right) \cos \left( \frac{z_1 - z_2}{2} \right)$$

4.3.35

$$\sin z_1 - \sin z_2 = 2 \cos \left( \frac{z_1 + z_2}{2} \right) \sin \left( \frac{z_1 - z_2}{2} \right)$$

4.3.36

$$\cos z_1 + \cos z_2 = 2 \cos \left( \frac{z_1 + z_2}{2} \right) \cos \left( \frac{z_1 - z_2}{2} \right)$$

4.3.37

$$\cos z_1 - \cos z_2 = -2 \sin \left( \frac{z_1 + z_2}{2} \right) \sin \left( \frac{z_1 - z_2}{2} \right)$$

4.3.38

$$\tan z_1 \pm \tan z_2 = \frac{\sin(z_1 \pm z_2)}{\cos z_1 \cos z_2}$$

4.3.39

$$\cot z_1 \pm \cot z_2 = \frac{\sin(z_2 \pm z_1)}{\sin z_1 \sin z_2}$$

Relations Between Squares of Sines and Cosines

4.3.40

$$\sin^2 z_1 - \sin^2 z_2 = \sin(z_1 + z_2) \sin(z_1 - z_2)$$

4.3.41

$$\cos^2 z_1 - \cos^2 z_2 = -\sin(z_1 + z_2) \sin(z_1 - z_2)$$

4.3.42

$$\cos^2 z_1 - \sin^2 z_2 = \cos(z_1 + z_2) \cos(z_1 - z_2)$$

4.3.43

Signs of the Circular Functions in the Four Quadrants

| Quadrant | sin<br>csc | cos<br>sec | tan<br>cot |
|----------|------------|------------|------------|
| I        | +          | +          | +          |
| II       | +          | -          | -          |
| III      | -          | -          | +          |
| IV       | -          | +          | -          |

4.3.44

Functions of Angles in Any Quadrant in Terms of Angles in the First Quadrant. ( $0 \leq \theta \leq \frac{\pi}{2}$ ,  $k$  any integer)

|          | $-\theta$      | $\frac{\pi}{2} \pm \theta$ | $\pi \pm \theta$  | $\frac{3\pi}{2} \pm \theta$ | $2k\pi \pm \theta$ |
|----------|----------------|----------------------------|-------------------|-----------------------------|--------------------|
| sin..... | $-\sin \theta$ | $\cos \theta$              | $\mp \sin \theta$ | $-\cos \theta$              | $\pm \sin \theta$  |
| cos..... | $\cos \theta$  | $\mp \sin \theta$          | $-\cos \theta$    | $\pm \sin \theta$           | $\pm \cos \theta$  |
| tan..... | $-\tan \theta$ | $\mp \cot \theta$          | $\pm \tan \theta$ | $\mp \cot \theta$           | $\pm \tan \theta$  |
| csc..... | $-\csc \theta$ | $+\sec \theta$             | $\mp \csc \theta$ | $-\sec \theta$              | $\pm \csc \theta$  |
| sec..... | $\sec \theta$  | $\mp \csc \theta$          | $-\sec \theta$    | $\pm \csc \theta$           | $+\sec \theta$     |
| cot..... | $-\cot \theta$ | $\mp \tan \theta$          | $\pm \cot \theta$ | $\mp \tan \theta$           | $\pm \cot \theta$  |

4.3.45

Relations Between Circular (or Inverse Circular) Functions

|            | $\sin x = a$                    | $\cos x = a$                    | $\tan x = a$                    | $\csc x = a$                    | $\sec x = a$                    | $\cot x = a$                    |
|------------|---------------------------------|---------------------------------|---------------------------------|---------------------------------|---------------------------------|---------------------------------|
| sin x..... | $a$                             | $(1 - a^2)^{\frac{1}{2}}$       | $a(1 + a^2)^{-\frac{1}{2}}$     | $a^{-1}$                        | $a^{-1}(a^2 - 1)^{\frac{1}{2}}$ | $(1 + a^2)^{-\frac{1}{2}}$      |
| cos x..... | $(1 - a^2)^{\frac{1}{2}}$       | $a$                             | $(1 + a^2)^{-\frac{1}{2}}$      | $a^{-1}(a^2 - 1)^{\frac{1}{2}}$ | $a^{-1}$                        | $a(1 + a^2)^{-\frac{1}{2}}$     |
| tan x..... | $a(1 - a^2)^{-\frac{1}{2}}$     | $a^{-1}(1 - a^2)^{\frac{1}{2}}$ | $a$                             | $(a^2 - 1)^{-\frac{1}{2}}$      | $(a^2 - 1)^{\frac{1}{2}}$       | $a^{-1}$                        |
| csc x..... | $a^{-1}$                        | $(1 - a^2)^{-\frac{1}{2}}$      | $a^{-1}(1 + a^2)^{\frac{1}{2}}$ | $a$                             | $a(a^2 - 1)^{-\frac{1}{2}}$     | $(1 + a^2)^{\frac{1}{2}}$       |
| sec x..... | $(1 - a^2)^{-\frac{1}{2}}$      | $a^{-1}$                        | $(1 + a^2)^{\frac{1}{2}}$       | $a(a^2 - 1)^{-\frac{1}{2}}$     | $a$                             | $a^{-1}(1 + a^2)^{\frac{1}{2}}$ |
| cot x..... | $a^{-1}(1 - a^2)^{\frac{1}{2}}$ | $a(1 - a^2)^{-\frac{1}{2}}$     | $a^{-1}$                        | $(a^2 - 1)^{\frac{1}{2}}$       | $(a^2 - 1)^{-\frac{1}{2}}$      | $a$                             |

$(0 \leq x \leq \frac{\pi}{2})$  Illustration: If  $\sin x = a$ ,  $\cot x = a^{-1}(1 - a^2)^{\frac{1}{2}}$   
 $\operatorname{arcsec} a = \operatorname{arccot} (a^2 - 1)^{-\frac{1}{2}}$



## 4.3.46 Circular Functions for Certain Angles

|     | 0<br>0°  | $\frac{\pi}{12}$<br>15°          | $\frac{\pi}{6}$<br>30° | $\frac{\pi}{4}$<br>45° | $\frac{\pi}{3}$<br>60° |
|-----|----------|----------------------------------|------------------------|------------------------|------------------------|
| sin | 0        | $\frac{\sqrt{2}}{4}(\sqrt{3}-1)$ | 1/2                    | $\sqrt{2}/2$           | $\sqrt{3}/2$           |
| cos | 1        | $\frac{\sqrt{2}}{4}(\sqrt{3}+1)$ | $\sqrt{3}/2$           | $\sqrt{2}/2$           | 1/2                    |
| tan | 0        | $2-\sqrt{3}$                     | $\sqrt{3}/3$           | 1                      | $\sqrt{3}$             |
| csc | $\infty$ | $\sqrt{2}(\sqrt{3}+1)$           | 2                      | $\sqrt{2}$             | $2\sqrt{3}/3$          |
| sec | 1        | $\sqrt{2}(\sqrt{3}-1)$           | $2\sqrt{3}/3$          | $\sqrt{2}$             | 2                      |
| cot | $\infty$ | $2+\sqrt{3}$                     | $\sqrt{3}$             | 1                      | $\sqrt{3}/3$           |

|     | $\frac{5\pi}{12}$<br>75°         | $\frac{\pi}{2}$<br>90° | $\frac{7\pi}{12}$<br>105°         | $\frac{2\pi}{3}$<br>120° |
|-----|----------------------------------|------------------------|-----------------------------------|--------------------------|
| sin | $\frac{\sqrt{2}}{4}(\sqrt{3}+1)$ | 1                      | $\frac{\sqrt{2}}{4}(\sqrt{3}+1)$  | $\sqrt{3}/2$             |
| cos | $\frac{\sqrt{2}}{4}(\sqrt{3}-1)$ | 0                      | $-\frac{\sqrt{2}}{4}(\sqrt{3}-1)$ | -1/2                     |
| tan | $2+\sqrt{3}$                     | $\infty$               | $-(2+\sqrt{3})$                   | $-\sqrt{3}$              |
| csc | $\sqrt{2}(\sqrt{3}-1)$           | 1                      | $\sqrt{2}(\sqrt{3}-1)$            | $2\sqrt{3}/3$            |
| sec | $\sqrt{2}(\sqrt{3}+1)$           | $\infty$               | $-\sqrt{2}(\sqrt{3}+1)$           | -2                       |
| cot | $2-\sqrt{3}$                     | 0                      | $-(2-\sqrt{3})$                   | $-\sqrt{3}/3$            |

|     | $\frac{3\pi}{4}$<br>135° | $\frac{5\pi}{6}$<br>150° | $\frac{11\pi}{12}$<br>165°        | $\pi$<br>180° |
|-----|--------------------------|--------------------------|-----------------------------------|---------------|
| sin | $\sqrt{2}/2$             | 1/2                      | $\frac{\sqrt{2}}{4}(\sqrt{3}-1)$  | 0             |
| cos | $-\sqrt{2}/2$            | $-\sqrt{3}/2$            | $-\frac{\sqrt{2}}{4}(\sqrt{3}+1)$ | -1            |
| tan | -1                       | $-\sqrt{3}/3$            | $-(2-\sqrt{3})$                   | 0             |
| csc | $\sqrt{2}$               | 2                        | $\sqrt{2}(\sqrt{3}+1)$            | $\infty$      |
| sec | $-\sqrt{2}$              | $-2\sqrt{3}/3$           | $-\sqrt{2}(\sqrt{3}-1)$           | -1            |
| cot | -1                       | $-\sqrt{3}$              | $-(2+\sqrt{3})$                   | $\infty$      |

## Euler's Formula

4.3.47 
$$e^z = e^{x+iy} = e^x (\cos y + i \sin y)$$

## De Moivre's Theorem

4.3.48 
$$(\cos z + i \sin z)^n = \cos nz + i \sin nz$$
  
$$(-\pi < \Re z \leq \pi \text{ unless } n \text{ is an integer})$$

## Relation to Hyperbolic Functions (see 4.5.7 to 4.5.12)

4.3.49 
$$\sin z = -i \sinh iz$$

4.3.50 
$$\cos z = \cosh iz$$

4.3.51 
$$\tan z = -i \tanh iz$$

4.3.52 
$$\csc z = i \operatorname{csch} iz$$

4.3.53 
$$\sec z = \operatorname{sech} iz$$

4.3.54 
$$\cot z = i \operatorname{coth} iz$$

## Circular Functions in Terms of Real and Imaginary Parts

4.3.55 
$$\sin z = \sin x \cosh y + i \cos x \sinh y$$

4.3.56 
$$\cos z = \cos x \cosh y - i \sin x \sinh y$$

4.3.57 
$$\tan z = \frac{\sin 2x + i \sinh 2y}{\cos 2x + \cosh 2y}$$

4.3.58 
$$\cot z = \frac{\sin 2x - i \sinh 2y}{\cosh 2y - \cos 2x}$$

## Modulus and Phase (Argument) of Circular Functions

4.3.59 
$$|\sin z| = (\sin^2 x + \sinh^2 y)^{\frac{1}{2}}$$
  
$$= [\frac{1}{2} (\cosh 2y - \cos 2x)]^{\frac{1}{2}}$$

4.3.60 
$$\arg \sin z = \arctan (\cot x \tanh y)$$

4.3.61 
$$|\cos z| = (\cos^2 x + \sinh^2 y)^{\frac{1}{2}}$$
  
$$= [\frac{1}{2} (\cosh 2y + \cos 2x)]^{\frac{1}{2}}$$

4.3.62 
$$\arg \cos z = -\arctan (\tan x \tanh y)$$

4.3.63 
$$|\tan z| = \left( \frac{\cosh 2y - \cos 2x}{\cosh 2y + \cos 2x} \right)^{\frac{1}{2}}$$

4.3.64 
$$\arg \tan z = \arctan \left( \frac{\sinh 2y}{\sin 2x} \right)$$

## Series Expansions

4.3.65

$$\sin z = z - \frac{z^3}{3!} + \frac{z^5}{5!} - \frac{z^7}{7!} + \dots \quad (|z| < \infty)$$

4.3.66

$$\cos z = 1 - \frac{z^2}{2!} + \frac{z^4}{4!} - \frac{z^6}{6!} + \dots \quad (|z| < \infty)$$

4.3.67

$$\tan z = z + \frac{z^3}{3} + \frac{2z^5}{15} + \frac{17z^7}{315} + \dots$$

$$+ \frac{(-1)^{n-1} 2^{2n} (2^{2n}-1) B_{2n}}{(2n)!} z^{2n-1} + \dots \quad \left(|z| < \frac{\pi}{2}\right)$$

4.3.68

$$\csc z = \frac{1}{z} + \frac{z}{6} + \frac{7z^3}{360} + \frac{31z^5}{15120} + \dots$$

$$+ \frac{(-1)^{n-1} 2(2^{2n-1}-1) B_{2n}}{(2n)!} z^{2n-1} + \dots \quad (|z| < \pi)$$

4.3.69

$$\sec z = 1 + \frac{z^2}{2} + \frac{5z^4}{24} + \frac{61z^6}{720} + \dots$$

$$+ \frac{(-1)^n E_{2n}}{(2n)!} z^{2n} + \dots \quad \left(|z| < \frac{\pi}{2}\right)$$

4.3.70

$$\cot z = \frac{1}{z} - \frac{z}{3} + \frac{z^3}{45} - \frac{2z^5}{945} + \dots$$

$$- \frac{(-1)^{n-1} 2^{2n} B_{2n}}{(2n)!} z^{2n-1} + \dots \quad (|z| < \pi)$$

4.3.71

$$\ln \frac{\sin z}{z} = \sum_{n=1}^{\infty} \frac{(-1)^n 2^{2n-1} B_{2n}}{n(2n)!} z^{2n} \quad (|z| < \pi)$$

4.3.72

$$\ln \cos z = \sum_{n=1}^{\infty} \frac{(-1)^n 2^{2n-1} (2^{2n}-1) B_{2n}}{n(2n)!} z^{2n} \quad (|z| < \frac{1}{2}\pi)$$

4.3.73

$$\ln \frac{\tan z}{z} = \sum_{n=1}^{\infty} \frac{(-1)^{n-1} 2^{2n} (2^{2n-1}-1) B_{2n}}{n(2n)!} z^{2n}$$

$$( |z| < \frac{1}{2}\pi )$$

where  $B_n$  and  $E_n$  are the Bernoulli and Euler numbers (see chapter 23).

Limiting Values

4.3.74  $\lim_{x \rightarrow 0} \frac{\sin x}{x} = 1$

4.3.75  $\lim_{x \rightarrow 0} \frac{\tan x}{x} = 1$

4.3.76  $\lim_{n \rightarrow \infty} n \sin \frac{x}{n} = x$

4.3.77  $\lim_{n \rightarrow \infty} n \tan \frac{x}{n} = x$

4.3.78  $\lim_{n \rightarrow \infty} \cos \frac{x}{n} = 1$

Inequalities

4.3.79  $\frac{\sin x}{x} > \frac{2}{\pi} \quad \left(-\frac{\pi}{2} < x < \frac{\pi}{2}\right)$

4.3.80  $\sin x \leq x \leq \tan x \quad \left(0 \leq x \leq \frac{\pi}{2}\right)$

4.3.81  $\cos x \leq \frac{\sin x}{x} \leq 1 \quad (0 \leq x \leq \pi)$

4.3.82  $\pi < \frac{\sin \pi x}{x(1-x)} \leq 4 \quad (0 < x < 1)$

4.3.83  $|\sinh y| \leq |\sin z| \leq \cosh y$

4.3.84  $|\sinh y| \leq |\cos z| \leq \cosh y$

4.3.85  $|\csc z| \leq \operatorname{csch} |y|$

4.3.86  $|\cos z| \leq \cosh |z|$

4.3.87  $|\sin z| \leq \sinh |z|$

4.3.88  $|\cos z| < 2, \quad |\sin z| \leq \frac{6}{5} |z| \quad (|z| < 1)$

Infinite Products

4.3.89  $\sin z = z \prod_{k=1}^{\infty} \left(1 - \frac{z^2}{k^2 \pi^2}\right)$

4.3.90  $\cos z = \prod_{k=1}^{\infty} \left(1 - \frac{4z^2}{(2k-1)^2 \pi^2}\right)$

Expansion in Partial Fractions

4.3.91  $\cot z = \frac{1}{z} + 2z \sum_{k=1}^{\infty} \frac{1}{z^2 - k^2 \pi^2}$   
 $(z \neq 0, \pm \pi, \pm 2\pi, \dots)$

4.3.92  $\csc^2 z = \sum_{k=-\infty}^{\infty} \frac{1}{(z - k\pi)^2}$   
 $(z \neq 0, \pm \pi, \pm 2\pi, \dots)$

4.3.93  $\csc z = \frac{1}{z} + 2z \sum_{k=1}^{\infty} \frac{(-1)^k}{z^2 - k^2 \pi^2}$   
 $(z \neq 0, \pm \pi, \pm 2\pi, \dots)$

Continued Fractions

4.3.94  $\tan z = \frac{z}{1 - \frac{z^2}{3 - \frac{z^2}{5 - \frac{z^2}{7 - \dots}}}} \quad \left(z \neq \frac{\pi}{2} \pm n\pi\right)$

4.3.95

$$\tan az = \frac{a \tan z (1-a^2) \tan^2 z (4-a^2) \tan^2 z}{1 + \frac{3 + \frac{5 + \frac{7 + \dots}{7 + \frac{9-a^2}{7 + \dots}} \tan^2 z \dots \left(-\frac{\pi}{2} < \Re z < \frac{\pi}{2}, \quad az \neq \frac{\pi}{2} \pm n\pi\right)}$$

Polynomial Approximations <sup>7</sup>

4.3.96

$$0 \leq x \leq \frac{\pi}{2}$$

$$\frac{\sin x}{x} = 1 + a_2 x^2 + a_4 x^4 + \epsilon(x)$$

$$|\epsilon(x)| \leq 2 \times 10^{-4}$$

$$a_2 = -.16605 \quad a_4 = .00761$$

4.3.97

$$0 \leq x \leq \frac{\pi}{2}$$

$$\frac{\sin x}{x} = 1 + a_2 x^2 + a_4 x^4 + a_6 x^6 + a_8 x^8 + a_{10} x^{10} + \epsilon(x)$$

$$|\epsilon(x)| \leq 2 \times 10^{-9}$$

$$a_2 = -.16666 \ 66664 \quad a_8 = .00000 \ 27526$$

$$a_4 = .00833 \ 33315 \quad a_{10} = -.00000 \ 00239$$

$$a_6 = -.00019 \ 84090$$

4.3.98

$$0 \leq x \leq \frac{\pi}{2}$$

$$\cos x = 1 + a_2 x^2 + a_4 x^4 + \epsilon(x)$$

$$|\epsilon(x)| \leq 9 \times 10^{-4}$$

$$a_2 = -.49670 \quad a_4 = .03705$$

4.3.99

$$0 \leq x \leq \frac{\pi}{2}$$

$$\cos x = 1 + a_2 x^2 + a_4 x^4 + a_6 x^6 + a_8 x^8 + a_{10} x^{10} + \epsilon(x)$$

$$|\epsilon(x)| \leq 2 \times 10^{-9}$$

$$a_2 = -.49999 \ 99963 \quad a_8 = .00002 \ 47609$$

$$a_4 = .04166 \ 66418 \quad a_{10} = -.00000 \ 02605$$

$$a_6 = -.00138 \ 88397$$

4.3.100

$$0 \leq x \leq \frac{\pi}{4}$$

$$\frac{\tan x}{x} = 1 + a_2 x^2 + a_4 x^4 + \epsilon(x)$$

$$|\epsilon(x)| \leq 1 \times 10^{-3}$$

$$a_2 = .31755 \quad a_4 = .20330$$

4.3.101

$$0 \leq x \leq \frac{\pi}{4}$$

$$\frac{\tan x}{x} = 1 + a_2 x^2 + a_4 x^4 + a_6 x^6 + a_8 x^8 + a_{10} x^{10} + a_{12} x^{12} + \epsilon(x)$$

$$|\epsilon(x)| \leq 2 \times 10^{-8}$$

$$a_2 = .33333 \ 14036 \quad a_8 = .02456 \ 50893$$

$$a_4 = .13339 \ 23995 \quad a_{10} = .00290 \ 05250$$

$$a_6 = .05337 \ 40603 \quad a_{12} = .00951 \ 68091$$

4.3.102

$$0 \leq x \leq \frac{\pi}{4}$$

$$* \quad x \cot x = 1 + a_2 x^2 + a_4 x^4 + \epsilon(x)$$

$$|\epsilon(x)| \leq 3 \times 10^{-5}$$

$$a_2 = -.332867 \quad a_4 = -.024369$$

4.3.103

$$0 \leq x \leq \frac{\pi}{4}$$

$$x \cot x = 1 + a_2 x^2 + a_4 x^4 + a_6 x^6 + a_8 x^8 + a_{10} x^{10} + \epsilon(x)$$

$$|\epsilon(x)| \leq 4 \times 10^{-10}$$

$$a_2 = -.33333 \ 33410 \quad a_8 = -.00020 \ 78504$$

$$a_4 = -.02222 \ 20287 \quad a_{10} = -.00002 \ 62619$$

$$a_6 = -.00211 \ 77168$$

Approximations in Terms of Chebyshev Polynomials <sup>8</sup>

4.3.104

$$-1 \leq x \leq 1$$

$$T_n^*(x) = \cos n\theta, \cos \theta = 2x - 1 \quad (\text{see chapter 22})$$

$$\sin \frac{1}{2}\pi x = x \sum_{n=0}^{\infty} A_n T_n^*(x^2) \quad \cos \frac{1}{2}\pi x = \sum_{n=0}^{\infty} A_n T_n^*(x^2)$$

| $n$ | $A_n$        | $n$ | $A_n$        |
|-----|--------------|-----|--------------|
| 0   | 1.27627 8962 | 0   | .47200 1216  |
| 1   | -.28526 1569 | 1   | -.49940 3258 |
| 2   | .00911 8016  | 2   | .02799 2080  |
| 3   | -.00013 6587 | 3   | -.00059 6695 |
| 4   | .00000 1185  | 4   | .00000 6704  |
| 5   | -.00000 0007 | 5   | -.00000 0047 |

<sup>7</sup> The approximations 4.3.96 to 4.3.103 are from B. Carlson, M. Goldstein, Rational approximation of functions, Los Alamos Scientific Laboratory LA-1943, Los Alamos, N. Mex., 1955 (with permission).

<sup>8</sup> The approximations 4.3.104 are from C. W. Clenshaw, Polynomial approximations to elementary functions, Math. Tables Aids Comp. 8, 143-147 (1954) (with permission).

\*See page II.

**Differentiation Formulas**

4.3.105  $\frac{d}{dz} \sin z = \cos z$

4.3.106  $\frac{d}{dz} \cos z = -\sin z$

4.3.107  $\frac{d}{dz} \tan z = \sec^2 z$

4.3.108  $\frac{d}{dz} \csc z = -\csc z \cot z$

4.3.109  $\frac{d}{dz} \sec z = \sec z \tan z$

4.3.110  $\frac{d}{dz} \cot z = -\csc^2 z$

4.3.111  $\frac{d^n}{dz^n} \sin z = \sin\left(z + \frac{1}{2}n\pi\right)$

4.3.112  $\frac{d^n}{dz^n} \cos z = \cos\left(z + \frac{1}{2}n\pi\right)$

**Integration Formulas**

4.3.113  $\int \sin z \, dz = -\cos z$

4.3.114  $\int \cos z \, dz = \sin z$

4.3.115  $\int \tan z \, dz = -\ln \cos z = \ln \sec z$

4.3.116

$$\int \csc z \, dz = \ln \tan \frac{z}{2} = \ln (\csc z - \cot z) = \frac{1}{2} \ln \frac{1 - \cos z}{1 + \cos z}$$

4.3.117

$$\int \sec z \, dz = \ln (\sec z + \tan z) = \ln \tan \left(\frac{\pi}{4} + \frac{z}{2}\right) = \text{gd}^{-1}(z)$$

= Inverse Gudermannian Function

$$\text{gd } z = 2 \arctan e^z - \frac{\pi}{2}$$

4.3.118  $\int \cot z \, dz = \ln \sin z = -\ln \csc z$

4.3.119

$$\int z^n \sin z \, dz = -z^n \cos z + n \int z^{n-1} \cos z \, dz$$

4.3.120

$$\int \frac{\sin z}{z^n} \, dz = \frac{-\sin z}{(n-1)z^{n-1}} + \frac{1}{n-1} \int \frac{\cos z}{z^{n-1}} \, dz \quad (n > 1)$$

4.3.121  $\int \frac{z}{\sin^2 z} \, dz = -z \cot z + \ln \sin z$

4.3.122

$$\int \frac{z \, dz}{\sin^n z} = \frac{-z \cos z}{(n-1) \sin^{n-1} z} - \frac{1}{(n-1)(n-2) \sin^{n-2} z} + \frac{(n-2)}{(n-1)} \int \frac{z \, dz}{\sin^{n-2} z} \quad (n > 2)$$

4.3.123

$$\int z^n \cos z \, dz = z^n \sin z - n \int z^{n-1} \sin z \, dz$$

4.3.124

$$\int \frac{\cos z}{z^n} \, dz = -\frac{\cos z}{(n-1)z^{n-1}} - \frac{1}{n-1} \int \frac{\sin z}{z^{n-1}} \, dz \quad (n > 1)$$

4.3.125  $\int \frac{z}{\cos^2 z} \, dz = z \tan z + \ln \cos z$

4.3.126

$$\int \frac{z \, dz}{\cos^n z} = \frac{z \sin z}{(n-1) \cos^{n-1} z} - \frac{1}{(n-1)(n-2) \cos^{n-2} z} + \frac{(n-2)}{(n-1)} \int \frac{z \, dz}{\cos^{n-2} z} \quad (n > 2)$$

4.3.127

$$\begin{aligned} \int \sin^m z \cos^n z \, dz &= \frac{\sin^{m+1} z \cos^{n-1} z}{m+n} \\ &+ \frac{(n-1)}{(m+n)} \int \sin^m z \cos^{n-2} z \, dz \\ &= -\frac{\sin^{m-1} z \cos^{n+1} z}{m+n} \\ &+ \frac{(m-1)}{(m+n)} \int \sin^{m-2} z \cos^n z \, dz \quad (m \neq -n) \end{aligned}$$

4.3.128

$$\begin{aligned} \int \frac{dz}{\sin^m z \cos^n z} &= \frac{1}{(n-1) \sin^{m-1} z \cos^{n-1} z} \\ &+ \frac{m+n-2}{n-1} \int \frac{dz}{\sin^m z \cos^{n-2} z} \quad (n > 1) \\ &= \frac{-1}{(m-1) \sin^{m-1} z \cos^{n-1} z} \\ &+ \frac{m+n-2}{m-1} \int \frac{dz}{\sin^{m-2} z \cos^n z} \quad (m > 1) \end{aligned}$$

4.3.129  $\int \tan^n z \, dz = \frac{\tan^{n-1} z}{n-1} - \int \tan^{n-2} z \, dz \quad (n \neq 1)$

4.3.130  $\int \cot^n z \, dz = -\frac{\cot^{n-1} z}{n-1} - \int \cot^{n-2} z \, dz \quad (n \neq 1)$

4.3.131

$$\int \frac{dz}{a+b \sin z} = \frac{2}{(a^2-b^2)^{\frac{1}{2}}} \arctan \frac{a \tan \left(\frac{z}{2}\right) + b}{(a^2-b^2)^{\frac{1}{2}}} \quad (a^2 > b^2)$$

$$= \frac{1}{(b^2-a^2)^{\frac{1}{2}}} \ln \left[ \frac{a \tan \left(\frac{z}{2}\right) + b - (b^2-a^2)^{\frac{1}{2}}}{a \tan \left(\frac{z}{2}\right) + b + (b^2-a^2)^{\frac{1}{2}}} \right] \quad (b^2 > a^2)$$

4.3.132

$$\int \frac{dz}{1 \pm \sin z} = \mp \tan \left( \frac{\pi}{4} \mp \frac{z}{2} \right)$$

4.3.133

$$\int \frac{dz}{a+b \cos z} = \frac{2}{(a^2-b^2)^{\frac{1}{2}}} \arctan \frac{(a-b) \tan \frac{z}{2}}{(a^2-b^2)^{\frac{1}{2}}} \quad (a^2 > b^2)$$

$$= \frac{1}{(b^2-a^2)^{\frac{1}{2}}} \ln \left[ \frac{(b-a) \tan \frac{z}{2} + (b^2-a^2)^{\frac{1}{2}}}{(b-a) \tan \frac{z}{2} - (b^2-a^2)^{\frac{1}{2}}} \right] \quad (b^2 > a^2)$$

4.3.134

$$\int \frac{dz}{1+\cos z} = \tan \frac{z}{2}$$

4.3.135

$$\int \frac{dz}{1-\cos z} = -\cot \frac{z}{2}$$

4.3.136

$$\int e^{az} \sin bz \, dz = \frac{e^{az}}{a^2+b^2} (a \sin bz - b \cos bz)$$

4.3.137

$$\int e^{az} \cos bz \, dz = \frac{e^{az}}{a^2+b^2} (a \cos bz + b \sin bz)$$

4.3.138

$$\int e^{az} \sin^n bz \, dz = \frac{e^{az} \sin^{n-1} bz}{a^2+n^2b^2} (a \sin bz - nb \cos bz) + \frac{n(n-1)b^2}{a^2+n^2b^2} \int e^{az} \sin^{n-2} bz \, dz$$

4.3.139

$$\int e^{az} \cos^n bz \, dz = \frac{e^{az} \cos^{n-1} bz}{a^2+n^2b^2} (a \cos bz + nb \sin bz) + \frac{n(n-1)b^2}{a^2+n^2b^2} \int e^{az} \cos^{n-2} bz \, dz$$

**Definite Integrals**

4.3.140

$$\int_0^\pi \sin mt \sin nt \, dt = 0 \quad (m \neq n, \quad m \text{ and } n \text{ integers})$$

$$\int_0^\pi \cos mt \cos nt \, dt = 0$$

4.3.141

$$\int_0^\pi \sin^2 nt \, dt = \int_0^\pi \cos^2 nt \, dt = \frac{\pi}{2} \quad (n \text{ an integer, } n \neq 0)$$

4.3.142

$$\int_0^\infty \frac{\sin mt}{t} \, dt = \begin{cases} \frac{\pi}{2} & (m > 0) \\ 0 & (m = 0) \\ -\frac{\pi}{2} & (m < 0) \end{cases}$$

4.3.143

$$\int_0^\infty \frac{\cos at - \cos bt}{t} \, dt = \ln(b/a)$$

4.3.144

$$\int_0^\infty \sin t^2 \, dt = \int_0^\infty \cos t^2 \, dt = \frac{1}{2} \sqrt{\frac{\pi}{2}}$$

4.3.145

$$\int_0^{\pi/2} \ln \sin t \, dt = \int_0^{\pi/2} \ln \cos t \, dt = -\frac{\pi}{2} \ln 2$$

4.3.146

$$\int_0^\infty \frac{\cos mt}{1+t^2} \, dt = \frac{\pi}{2} e^{-m}$$

(See chapters 5 and 7 for other integrals involving circular functions.)

(See [5.3] for Fourier transforms.)

4.3.147

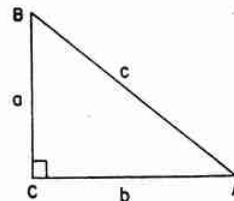
**Formulas for Solution of Plane Right Triangles**

If  $A$ ,  $B$  and  $C$  are the vertices ( $C$  the right angle), and  $a$ ,  $b$  and  $c$  the sides opposite respectively,

$$\sin A = \frac{a}{c} = \frac{1}{\csc A}$$

$$\cos A = \frac{b}{c} = \frac{1}{\sec A}$$

$$\tan A = \frac{a}{b} = \frac{1}{\cot A}$$

$$\text{versine } A = \text{vers } A = 1 - \cos A$$

$$\text{coversine } A = \text{covers } A = 1 - \sin A$$

$$\text{haversine } A = \text{hav } A = \frac{1}{2} \text{vers } A$$

$$\text{exsecant } A = \text{exsec } A = \sec A - 1$$

4.3.148

Formulas for Solution of Plane Triangles

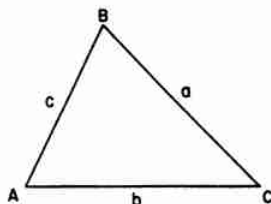

In a triangle with angles  $A$ ,  $B$  and  $C$  and sides opposite  $a$ ,  $b$  and  $c$  respectively,

$$\frac{a}{\sin A} = \frac{b}{\sin B} = \frac{c}{\sin C}$$

$$\cos A = \frac{c^2 + b^2 - a^2}{2bc}$$

$$a = b \cos C + c \cos B$$

$$\frac{a+b}{a-b} = \frac{\tan \frac{1}{2}(A+B)}{\tan \frac{1}{2}(A-B)}$$

$$\text{area} = \frac{bc \sin A}{2} = [s(s-a)(s-b)(s-c)]^{\frac{1}{2}}$$

$$s = \frac{1}{2}(a+b+c)$$

4.3.149

Formulas for Solution of Spherical Triangles

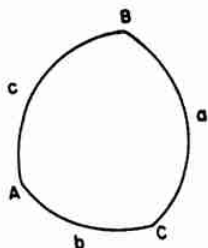

If  $A$ ,  $B$  and  $C$  are the three angles and  $a$ ,  $b$  and  $c$  the opposite sides,

$$\frac{\sin A}{\sin a} = \frac{\sin B}{\sin b} = \frac{\sin C}{\sin c}$$

$$\cos a = \cos b \cos c + \sin b \sin c \cos A$$

$$= \frac{\cos b \cos(c \pm \theta)}{\cos \theta}$$

where  $\tan \theta = \tan b \cos A$

$$\cos A = -\cos B \cos C + \sin B \sin C \cos a$$

4.4. Inverse Circular Functions

Definitions

4.4.1

$$\arcsin z = \int_0^z \frac{dt}{(1-t^2)^{\frac{1}{2}}} \quad (z=x+iy)$$

4.4.2

$$\arccos z = \int_z^1 \frac{dt}{(1-t^2)^{\frac{1}{2}}} = \frac{\pi}{2} - \arcsin z$$

4.4.3

$$\arctan z = \int_0^z \frac{dt}{1+t^2} \quad *$$

The path of integration must not cross the real axis in the case of 4.4.1 and 4.4.2 and the imaginary axis in the case of 4.4.3 except possibly inside the unit circle. Each function is single-valued and regular in the  $z$ -plane cut along the real axis from  $-\infty$  to  $-1$  and  $+1$  to  $+\infty$  in the case of 4.4.1 and 4.4.2 and along the imaginary axis from  $i$  to  $i\infty$  and  $-i$  to  $-i\infty$  in the case of 4.4.3.

Inverse circular functions are also written  $\arcsin z = \sin^{-1} z$ ,  $\arccos z = \cos^{-1} z$ ,  $\arctan z = \tan^{-1} z$ , . . . .

When  $-1 \leq x \leq 1$ ,  $\arcsin x$  and  $\arccos x$  are real and

4.4.4  $-\frac{1}{2}\pi \leq \arcsin x \leq \frac{1}{2}\pi, \quad 0 \leq \arccos x \leq \pi$

4.4.5  $\arctan z + \operatorname{arccot} z = \pm \frac{\pi}{2} \quad \Re z \geq 0$   
 $\phantom{4.4.5} \phantom{\arctan z + \operatorname{arccot} z} = \pm \frac{\pi}{2} \quad \Re z < 0^*$

4.4.6  $\operatorname{arccsc} z = \arcsin 1/z$

4.4.7  $\operatorname{arcsec} z = \arccos 1/z$

4.4.8  $\operatorname{arccot} z = \arctan 1/z$

4.4.9  $\operatorname{arcsec} z + \operatorname{arccsc} z = \frac{1}{2}\pi$

(see 4.3.45)

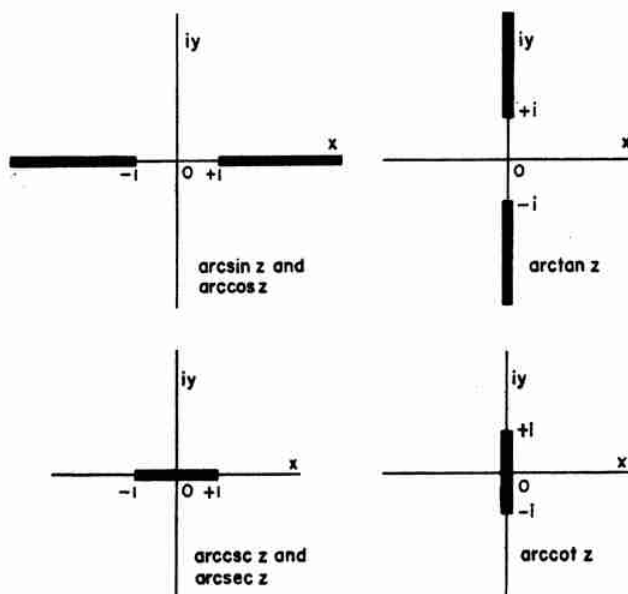

FIGURE 4.4. Branch cuts for inverse circular functions.



**Fundamental Property**

The general solutions of the equations

$$\sin t = z$$

$$\cos t = z$$

$$\tan t = z$$

are respectively

$$4.4.10 \quad t = \text{Arcsin } z = (-1)^k \arcsin z + k\pi$$

$$4.4.11 \quad t = \text{Arccos } z = \pm \arccos z + 2k\pi$$

$$4.4.12 \quad t = \text{Arctan } z = \arctan z + k\pi \quad (z^2 \neq -1)$$

where  $k$  is an arbitrary integer.

**4.4.13 Interval containing principal value**

| $y$ | $x$ positive<br>or zero | $x$ negative |
|-----|-------------------------|--------------|
|-----|-------------------------|--------------|

$$\arcsin x \text{ and } \arctan x \quad 0 \leq y \leq \pi/2 \quad -\pi/2 \leq y < 0$$

$$*\arccos x \text{ and } \text{arcsec } x \quad 0 \leq y \leq \pi/2 \quad \pi/2 < y \leq \pi$$

$$*\text{arccot } x \text{ and } \text{arccsc } x \quad 0 \leq y \leq \pi/2 \quad -\pi/2 \leq y < 0$$

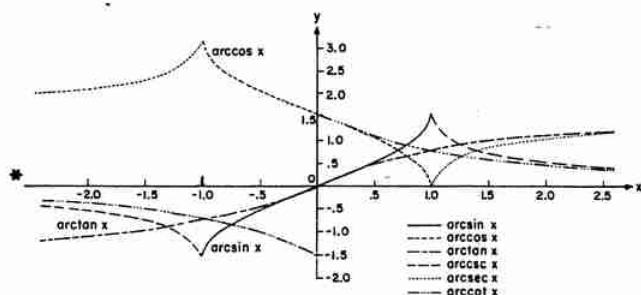

FIGURE 4.5. Inverse circular functions.

**Functions of Negative Arguments**

$$4.4.14 \quad \arcsin(-z) = -\arcsin z$$

$$4.4.15 \quad \arccos(-z) = \pi - \arccos z$$

$$4.4.16 \quad \arctan(-z) = -\arctan z$$

$$4.4.17 \quad \text{arccsc}(-z) = -\text{arccsc } z$$

$$4.4.18 \quad \text{arcsec}(-z) = \pi - \text{arcsec } z$$

$$*4.4.19 \quad \text{arccot}(-z) = -\text{arccot } z$$

**Relation to Inverse Hyperbolic Functions** (see 4.6.14 to 4.6.19)

$$4.4.20 \quad \text{Arcsin } z = -i \text{Arcsinh } iz$$

$$4.4.21 \quad \text{Arccos } z = \pm i \text{Arccosh } z$$

$$4.4.22 \quad \text{Arctan } z = -i \text{Arctanh } iz \quad (z^2 \neq -1)$$

$$4.4.23 \quad \text{Arccsc } z = i \text{Arccsch } iz$$

$$4.4.24 \quad \text{Arcsec } z = \pm i \text{Arcsech } z$$

$$4.4.25 \quad \text{Arccot } z = i \text{Arccoth } iz$$

**Logarithmic Representations**

$$4.4.26 \quad \text{Arcsin } x = -i \text{Ln} [(1-x^2)^{-1/2} + ix] \quad (x^2 \leq 1)$$

$$4.4.27 \quad \text{Arccos } x = -i \text{Ln} [x + i(1-x^2)^{1/2}] \quad (x^2 \leq 1)$$

$$4.4.28 \quad \text{Arctan } x = \frac{i}{2} \text{Ln} \frac{1-ix}{1+ix} = \frac{i}{2} \text{Ln} \frac{i+x}{i-x} \quad (x \text{ real})$$

$$4.4.29 \quad \text{Arccsc } x = -i \text{Ln} \left[ \frac{(x^2-1)^{1/2} + i}{x} \right] \quad (x^2 \geq 1)$$

$$4.4.30 \quad \text{Arcsec } x = -i \text{Ln} \left[ \frac{1+i(x^2-1)^{1/2}}{x} \right] \quad (x^2 \geq 1)$$

$$4.4.31 \quad \text{Arccot } x = \frac{i}{2} \text{Ln} \left( \frac{ix+1}{ix-1} \right) = \frac{i}{2} \text{Ln} \left( \frac{x-i}{x+i} \right) \quad (x \text{ real})$$

**Addition and Subtraction of Two Inverse Circular Functions****4.4.32**

$$\text{Arcsin } z_1 \pm \text{Arcsin } z_2 = \text{Arcsin} [z_1(1-z_2^2)^{1/2} \pm z_2(1-z_1^2)^{1/2}]$$

**4.4.33**

$$\text{Arccos } z_1 \pm \text{Arccos } z_2 = \text{Arccos} \{ z_1 z_2 \mp [(1-z_1^2)(1-z_2^2)]^{1/2} \}$$

**4.4.34**

$$\text{Arctan } z_1 \pm \text{Arctan } z_2 = \text{Arctan} \left( \frac{z_1 \pm z_2}{1 \mp z_1 z_2} \right)$$

**4.4.35**

$$\begin{aligned} \text{Arcsin } z_1 \pm \text{Arccos } z_2 &= \text{Arcsin} \{ z_1 z_2 \pm [(1-z_1^2)(1-z_2^2)]^{1/2} \} \\ &= \text{Arccos} [z_2(1-z_1^2)^{1/2} \mp z_1(1-z_2^2)^{1/2}] \end{aligned}$$

**4.4.36**

$$\begin{aligned} \text{Arctan } z_1 \pm \text{Arccot } z_2 &= \text{Arctan} \left( \frac{z_1 z_2 \pm 1}{z_2 \mp z_1} \right) = \text{Arccot} \left( \frac{z_2 \mp z_1}{z_1 z_2 \pm 1} \right) \end{aligned}$$

**Inverse Circular Functions in Terms of Real and Imaginary Parts****4.4.37**

$$\begin{aligned} \text{Arcsin } z &= k\pi + (-1)^k \arcsin \beta \\ &\quad + (-1)^k i \ln [\alpha + (\alpha^2 - 1)^{1/2}] \end{aligned}$$

**4.4.38**

$$\text{Arccos } z = 2k\pi \pm \{ \arccos \beta - i \ln [\alpha + (\alpha^2 - 1)^{1/2}] \}$$

4.4.39

$$\text{Arctan } z = k\pi + \frac{1}{2} \arctan \left( \frac{2x}{1-x^2-y^2} \right) + \frac{i}{4} \ln \left[ \frac{x^2+(y+1)^2}{x^2+(y-1)^2} \right] \quad (z^2 \neq -1)$$

where  $k$  is an integer or zero and

$$\alpha = \frac{1}{2} [(x+1)^2 + y^2]^{\frac{1}{2}} + \frac{1}{2} [(x-1)^2 + y^2]^{\frac{1}{2}}$$

$$\beta = \frac{1}{2} [(x+1)^2 + y^2]^{\frac{1}{2}} - \frac{1}{2} [(x-1)^2 + y^2]^{\frac{1}{2}}$$

Series Expansions

4.4.40

$$\arcsin z = z + \frac{z^3}{2 \cdot 3} + \frac{1 \cdot 3z^5}{2 \cdot 4 \cdot 5} + \frac{1 \cdot 3 \cdot 5z^7}{2 \cdot 4 \cdot 6 \cdot 7} + \dots \quad (|z| < 1)$$

4.4.41

$$\arcsin (1-z) = \frac{\pi}{2} - (2z)^{\frac{1}{2}} \left[ 1 + \sum_{k=1}^{\infty} \frac{1 \cdot 3 \cdot 5 \dots (2k-1)}{2^{2k} (2k+1) k!} z^k \right] \quad (|z| < 2)$$

4.4.42

$$\arctan z = z - \frac{z^3}{3} + \frac{z^5}{5} - \frac{z^7}{7} + \dots \quad (|z| \leq 1 \text{ and } z^2 \neq -1)$$

$$= \frac{\pi}{2} - \frac{1}{z} + \frac{1}{3z^3} - \frac{1}{5z^5} + \dots \quad (|z| > 1 \text{ and } z^2 \neq -1)$$

$$= \frac{z}{1+z^2} \left[ 1 + \frac{2}{3} \frac{z^2}{1+z^2} + \frac{2 \cdot 4}{3 \cdot 5} \left( \frac{z^2}{1+z^2} \right)^2 + \dots \right] \quad (z^2 \neq -1)$$

Continued Fractions

4.4.43  $\arctan z = \frac{z}{1 + \frac{z^2}{3 + \frac{4z^2}{5 + \frac{9z^2}{7 + \frac{16z^2}{9 + \dots}}}}}$   
 ( $z$  in the cut plane of Figure 4.4.)

4.4.44  $\frac{\arcsin z}{\sqrt{1-z^2}} = \frac{z}{1 - \frac{1 \cdot 2z^2}{3 - \frac{1 \cdot 2z^2}{5 - \frac{3 \cdot 4z^2}{7 - \frac{3 \cdot 4z^2}{9 - \dots}}}}}$   
 ( $z$  in the cut plane of Figure 4.4.)

Polynomial Approximations <sup>9</sup>

4.4.45

$0 \leq x \leq 1$

$$\arcsin x = \frac{\pi}{2} - (1-x)^{\frac{1}{2}} (a_0 + a_1x + a_2x^2 + a_3x^3) + \epsilon(x)$$

$$|\epsilon(x)| \leq 5 \times 10^{-5}$$

|                      |                      |
|----------------------|----------------------|
| $a_0 = 1.57072 \ 88$ | $a_2 = .07426 \ 10$  |
| $a_1 = -.21211 \ 44$ | $a_3 = -.01872 \ 93$ |

4.4.46

$0 \leq x \leq 1$

$$\arcsin x = \frac{\pi}{2} - (1-x)^{\frac{1}{2}} (a_0 + a_1x + a_2x^2 + a_3x^3 + a_4x^4 + a_5x^5 + a_6x^6 + a_7x^7) + \epsilon(x)$$

$$|\epsilon(x)| \leq 2 \times 10^{-8}$$

|                         |                         |
|-------------------------|-------------------------|
| $a_0 = 1.57079 \ 63050$ | $a_4 = .03089 \ 18810$  |
| $a_1 = -.21459 \ 88016$ | $a_5 = -.01708 \ 81256$ |
| $a_2 = .08897 \ 89874$  | $a_6 = .00667 \ 00901$  |
| $a_3 = -.05017 \ 43046$ | $a_7 = -.00126 \ 24911$ |

4.4.47

$-1 \leq x \leq 1$

$$\arctan x = a_1x + a_3x^3 + a_5x^5 + a_7x^7 + a_9x^9 + \epsilon(x)$$

$$|\epsilon(x)| \leq 10^{-5}$$

|                      |                      |
|----------------------|----------------------|
| $a_1 = .99986 \ 60$  | $a_7 = -.08513 \ 30$ |
| $a_3 = -.33029 \ 95$ | $a_9 = .02083 \ 51$  |
| $a_5 = .18014 \ 10$  |                      |

4.4.48<sup>10</sup>

$-1 \leq x \leq 1$

$$\arctan x = \frac{x}{1 + .28x^2} + \epsilon(x)$$

$$|\epsilon(x)| \leq 5 \times 10^{-3}$$

4.4.49<sup>11</sup>

$0 \leq x \leq 1$

$$\frac{\arctan x}{x} = 1 + \sum_{k=1}^8 a_{2k} x^{2k} + \epsilon(x)$$

$$|\epsilon(x)| \leq 2 \times 10^{-8}$$

|                         |                            |
|-------------------------|----------------------------|
| $a_2 = -.33333 \ 14528$ | $a_{10} = -.07528 \ 96400$ |
| $a_4 = .19993 \ 55085$  | $a_{12} = .04290 \ 96138$  |
| $a_6 = -.14208 \ 89944$ | $a_{14} = -.01616 \ 57367$ |
| $a_8 = .10656 \ 26393$  | $a_{16} = .00286 \ 62257$  |

<sup>9</sup> The approximations 4.4.45 to 4.4.47 are from C. Hastings, Jr., Approximations for digital computers. Princeton Univ. Press, Princeton, N.J., 1955 (with permission).

<sup>10</sup> The approximation 4.4.48 is from C. Hastings, Jr., Note 143, Math. Tables Aids Comp. 6, 68 (1953) (with permission).

<sup>11</sup> The approximation 4.4.49 is from B. Carlson, M. Goldstein, Rational approximation of functions, Los Alamos Scientific Laboratory LA-1943, Los Alamos, N. Mex., 1955 (with permission).

Approximations in Terms of Chebyshev Polynomials<sup>12</sup>

4.4.50 
$$-1 \leq x \leq 1$$

$$T_n^*(x) = \cos n\theta, \quad \cos \theta = 2x - 1 \quad (\text{see chapter 22})$$

$$\arctan x = x \sum_{n=0}^{\infty} A_n T_n^*(x^2)$$

| $n$ | $A_n$        | $n$ | $A_n$        |
|-----|--------------|-----|--------------|
| 0   | .88137 3587  | 6   | .00000 3821  |
| 1   | -.10589 2925 | 7   | -.00000 0570 |
| 2   | .01113 5843  | 8   | .00000 0086  |
| 3   | -.00138 1195 | 9   | -.00000 0013 |
| 4   | .00018 5743  | 10  | .00000 0002  |
| 5   | -.00002 6215 |     |              |

\*For  $x > 1$ , use  $\arctan x = \frac{1}{2}\pi - \arctan(1/x)$ 

4.4.51 
$$-\frac{1}{2}\sqrt{2} \leq x \leq \frac{1}{2}\sqrt{2}$$

$$\arcsin x = x \sum_{n=0}^{\infty} A_n T_n^*(2x^2)$$

$$0 \leq x \leq \frac{1}{2}\sqrt{2}$$

$$\arccos x = \frac{1}{2}\pi - x \sum_{n=0}^{\infty} A_n T_n^*(2x^2)$$

| $n$ | $A_n$        | $n$ | $A_n$       |
|-----|--------------|-----|-------------|
| 0   | 1.05123 1959 | 5   | .00000 5881 |
| 1   | .05494 6487  | 6   | .00000 0777 |
| 2   | .00408 0631  | 7   | .00000 0107 |
| 3   | .00040 7890  | 8   | .00000 0015 |
| 4   | .00004 6985  | 9   | .00000 0002 |

For  $\frac{1}{2}\sqrt{2} \leq x \leq 1$ , use  $\arcsin x = \arccos(1-x^2)^{\frac{1}{2}}$ ,  $\arccos x = \arcsin(1-x^2)^{\frac{1}{2}}$ .

## Differentiation Formulas

4.4.52 
$$\frac{d}{dz} \arcsin z = (1-z^2)^{-\frac{1}{2}}$$

4.4.53 
$$\frac{d}{dz} \arccos z = -(1-z^2)^{-\frac{1}{2}}$$

4.4.54 
$$\frac{d}{dz} \arctan z = \frac{1}{1+z^2}$$

4.4.55 
$$\frac{d}{dz} \operatorname{arccot} z = \frac{-1}{1+z^2}$$

4.4.56 
$$\frac{d}{dz} \operatorname{arcsec} z = \frac{1}{z(z^2-1)^{\frac{1}{2}}}$$

4.4.57 
$$\frac{d}{dz} \operatorname{arccsc} z = -\frac{1}{z(z^2-1)^{\frac{1}{2}}}$$

## Integration Formulas

4.4.58 
$$\int \arcsin z \, dz = z \arcsin z + (1-z^2)^{\frac{1}{2}}$$

4.4.59 
$$\int \arccos z \, dz = z \arccos z - (1-z^2)^{\frac{1}{2}}$$

4.4.60 
$$\int \arctan z \, dz = z \arctan z - \frac{1}{2} \ln(1+z^2)$$

4.4.61 
$$\int \operatorname{arccsc} z \, dz = z \operatorname{arccsc} z \pm \ln[z + (z^2-1)^{\frac{1}{2}}]$$

$$\begin{cases} 0 < \operatorname{arccsc} z < \frac{\pi}{2} \\ -\frac{\pi}{2} < \operatorname{arccsc} z < 0 \end{cases}$$

4.4.62 
$$\int \operatorname{arcsec} z \, dz = z \operatorname{arcsec} z \mp \ln[z + (z^2-1)^{\frac{1}{2}}]$$

$$\begin{cases} 0 < \operatorname{arcsec} z < \frac{\pi}{2} \\ \frac{\pi}{2} < \operatorname{arcsec} z < \pi \end{cases}$$

4.4.63 
$$\int \operatorname{arccot} z \, dz = z \operatorname{arccot} z + \frac{1}{2} \ln(1+z^2)$$

4.4.64 
$$\int z \arcsin z \, dz = \left(\frac{z^2}{2} - \frac{1}{4}\right) \arcsin z + \frac{z}{4} (1-z^2)^{\frac{1}{2}}$$

4.4.65 
$$\int z^n \arcsin z \, dz = \frac{z^{n+1}}{n+1} \arcsin z - \frac{1}{n+1} \int \frac{z^{n+1}}{(1-z^2)^{\frac{1}{2}}} dz \quad (n \neq -1)$$

4.4.66 
$$\int z \arccos z \, dz = \left(\frac{z^2}{2} - \frac{1}{4}\right) \arccos z - \frac{z}{4} (1-z^2)^{\frac{1}{2}}$$

4.4.67 
$$\int z^n \operatorname{arccos} z \, dz = \frac{z^{n+1}}{n+1} \operatorname{arccos} z + \frac{1}{n+1} \int \frac{z^{n+1}}{(1-z^2)^{\frac{1}{2}}} dz \quad (n \neq -1)$$

4.4.68 
$$\int \arctan z \, dz = \frac{1}{2} (1+z^2) \arctan z - \frac{z}{2}$$

<sup>12</sup> The approximations 4.4.50 to 4.4.51 are from C. W. Clenshaw, Polynomial approximations to elementary functions, Math. Tables Aids Comp. 8, 143-147 (1954) (with permission).

4.4.69

$$\int z^n \arctan z \, dz = \frac{z^{n+1}}{n+1} \arctan z - \frac{1}{n+1} \int \frac{z^{n+1}}{1+z^2} \, dz$$

( $n \neq -1$ )

4.4.70

$$\int z \operatorname{arccot} z \, dz = \frac{1}{2} (1+z^2) \operatorname{arccot} z + \frac{z}{2}$$

4.4.71

$$\int z^n \operatorname{arccot} z \, dz = \frac{z^{n+1}}{n+1} \operatorname{arccot} z + \frac{1}{n+1} \int \frac{z^{n+1}}{1+z^2} \, dz$$

( $n \neq -1$ )

### 4.5. Hyperbolic Functions

#### Definitions

4.5.1  $\sinh z = \frac{e^z - e^{-z}}{2}$  ( $z = x + iy$ )

4.5.2  $\cosh z = \frac{e^z + e^{-z}}{2}$

4.5.3  $\tanh z = \sinh z / \cosh z$

4.5.4  $\operatorname{csch} z = 1 / \sinh z$

4.5.5  $\operatorname{sech} z = 1 / \cosh z$

4.5.6  $\operatorname{coth} z = 1 / \tanh z$

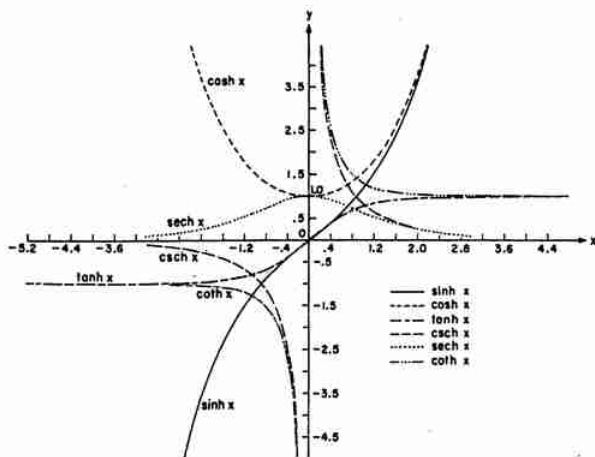

FIGURE 4.6. Hyperbolic functions.

Relation to Circular Functions (see 4.3.49 to 4.3.54)

Hyperbolic formulas can be derived from trigonometric identities by replacing  $z$  by  $iz$

4.5.7  $\sinh z = -i \sin iz$

4.5.8  $\cosh z = \cos iz$

4.5.9  $\tanh z = -i \tan iz$

4.5.10  $\operatorname{csch} z = i \csc iz$

4.5.11  $\operatorname{sech} z = \sec iz$

4.5.12  $\operatorname{coth} z = i \cot iz$

#### Periodic Properties

4.5.13  $\sinh (z + 2k\pi i) = \sinh z$   
( $k$  any integer)

4.5.14  $\cosh (z + 2k\pi i) = \cosh z$

4.5.15  $\tanh (z + k\pi i) = \tanh z$

#### Relations Between Hyperbolic Functions

4.5.16  $\cosh^2 z - \sinh^2 z = 1$

4.5.17  $\tanh^2 z + \operatorname{sech}^2 z = 1$

4.5.18  $\operatorname{coth}^2 z - \operatorname{csch}^2 z = 1$

4.5.19  $\cosh z + \sinh z = e^z$

4.5.20  $\cosh z - \sinh z = e^{-z}$

#### Negative Angle Formulas

4.5.21  $\sinh (-z) = -\sinh z$

4.5.22  $\cosh (-z) = \cosh z$

4.5.23  $\tanh (-z) = -\tanh z$

#### Addition Formulas

4.5.24  $\sinh (z_1 + z_2) = \sinh z_1 \cosh z_2$   
 $+ \cosh z_1 \sinh z_2$

4.5.25  $\cosh (z_1 + z_2) = \cosh z_1 \cosh z_2$   
 $+ \sinh z_1 \sinh z_2$

4.5.26  $\tanh (z_1 + z_2) = (\tanh z_1 + \tanh z_2) /$   
 $(1 + \tanh z_1 \tanh z_2)$

4.5.27  $\operatorname{coth} (z_1 + z_2) = (\operatorname{coth} z_1 \operatorname{coth} z_2 + 1) /$   
 $(\operatorname{coth} z_2 + \operatorname{coth} z_1)$

#### Half-Angle Formulas

4.5.28  $\sinh \frac{z}{2} = \left( \frac{\cosh z - 1}{2} \right)^{\frac{1}{2}}$

4.5.29

$$\cosh \frac{z}{2} = \left( \frac{\cosh z + 1}{2} \right)^{\frac{1}{2}}$$

4.5.30

$$\tanh \frac{z}{2} = \left( \frac{\cosh z - 1}{\cosh z + 1} \right)^{\frac{1}{2}} = \frac{\cosh z - 1}{\sinh z} = \frac{\sinh z}{\cosh z + 1}$$

**Multiple-Angle Formulas**

$$4.5.31 \quad \sinh 2z = 2 \sinh z \cosh z = \frac{2 \tanh z}{1 - \tanh^2 z}$$

$$4.5.32 \quad \cosh 2z = 2 \cosh^2 z - 1 = 2 \sinh^2 z + 1 \\ = \cosh^2 z + \sinh^2 z$$

$$4.5.33 \quad \tanh 2z = \frac{2 \tanh z}{1 + \tanh^2 z}$$

$$4.5.34 \quad \sinh 3z = 3 \sinh z + 4 \sinh^3 z$$

$$4.5.35 \quad \cosh 3z = -3 \cosh z + 4 \cosh^3 z$$

$$4.5.36 \quad \sinh 4z = 4 \sinh^3 z \cosh z + 4 \cosh^3 z \sinh z$$

$$4.5.37 \quad \cosh 4z = \cosh^4 z + 6 \sinh^2 z \cosh^2 z + \sinh^4 z$$

**Products of Hyperbolic Sines and Cosines**

$$4.5.38 \quad 2 \sinh z_1 \sinh z_2 = \cosh (z_1 + z_2) \\ - \cosh (z_1 - z_2)$$

$$4.5.39 \quad 2 \cosh z_1 \cosh z_2 = \cosh (z_1 + z_2) \\ + \cosh (z_1 - z_2)$$

$$4.5.40 \quad 2 \sinh z_1 \cosh z_2 = \sinh (z_1 + z_2) \\ + \sinh (z_1 - z_2)$$

**Addition and Subtraction of Two Hyperbolic Functions**

4.5.41

$$\sinh z_1 + \sinh z_2 = 2 \sinh \left( \frac{z_1 + z_2}{2} \right) \cosh \left( \frac{z_1 - z_2}{2} \right)$$

4.5.42

$$\sinh z_1 - \sinh z_2 = 2 \cosh \left( \frac{z_1 + z_2}{2} \right) \sinh \left( \frac{z_1 - z_2}{2} \right)$$

4.5.43

$$\cosh z_1 + \cosh z_2 = 2 \cosh \left( \frac{z_1 + z_2}{2} \right) \cosh \left( \frac{z_1 - z_2}{2} \right)$$

4.5.44

$$\cosh z_1 - \cosh z_2 = 2 \sinh \left( \frac{z_1 + z_2}{2} \right) \sinh \left( \frac{z_1 - z_2}{2} \right)$$

4.5.45

$$\tanh z_1 + \tanh z_2 = \frac{\sinh (z_1 + z_2)}{\cosh z_1 \cosh z_2}$$

4.5.46

$$\coth z_1 + \coth z_2 = \frac{\sinh (z_1 + z_2)}{\sinh z_1 \sinh z_2}$$

**Relations Between Squares of Hyperbolic Sines and Cosines**

4.5.47

$$\sinh^2 z_1 - \sinh^2 z_2 = \sinh (z_1 + z_2) \sinh (z_1 - z_2) \\ = \cosh^2 z_1 - \cosh^2 z_2$$

4.5.48

$$\sinh^2 z_1 + \cosh^2 z_2 = \cosh (z_1 + z_2) \cosh (z_1 - z_2) \\ = \cosh^2 z_1 + \sinh^2 z_2$$

**Hyperbolic Functions in Terms of Real and Imaginary Parts**

$$(z = x + iy)$$

$$4.5.49 \quad \sinh z = \sinh x \cos y + i \cosh x \sin y$$

$$4.5.50 \quad \cosh z = \cosh x \cos y + i \sinh x \sin y$$

$$4.5.51 \quad \tanh z = \frac{\sinh 2x + i \sin 2y}{\cosh 2x + \cos 2y}$$

$$4.5.52 \quad \coth z = \frac{\sinh 2x - i \sin 2y}{\cosh 2x - \cos 2y}$$

**De Moivre's Theorem**

$$4.5.53 \quad (\cosh z + \sinh z)^n = \cosh nz + \sinh nz$$

**Modulus and Phase (Argument) of Hyperbolic Functions**

$$4.5.54 \quad |\sinh z| = (\sinh^2 x + \sin^2 y)^{\frac{1}{2}} \\ = \left[ \frac{1}{2} (\cosh 2x - \cos 2y) \right]^{\frac{1}{2}}$$

$$4.5.55 \quad \arg \sinh z = \arctan (\coth x \tan y)$$

$$4.5.56 \quad |\cosh z| = (\sinh^2 x + \cos^2 y)^{\frac{1}{2}} \\ = \left[ \frac{1}{2} (\cosh 2x + \cos 2y) \right]^{\frac{1}{2}}$$

$$4.5.57 \quad \arg \cosh z = \arctan (\tanh x \tan y)$$

$$4.5.58 \quad |\tanh z| = \left( \frac{\cosh 2x - \cos 2y}{\cosh 2x + \cos 2y} \right)^{\frac{1}{2}}$$

$$4.5.59 \quad \arg \tanh z = \arctan \left( \frac{\sin 2y}{\sinh 2x} \right)$$

4.5.60 Relations Between Hyperbolic (or Inverse Hyperbolic) Functions

|                         | $\sinh x=a$                   | $\cosh x=a$                   | $\tanh x=a$                   | $\operatorname{csch} x=a$     | $\operatorname{sech} x=a$     | $\operatorname{coth} x=a$     |
|-------------------------|-------------------------------|-------------------------------|-------------------------------|-------------------------------|-------------------------------|-------------------------------|
| $\sinh x$               | $a$                           | $(a^2-1)^{\frac{1}{2}}$       | $a(1-a^2)^{-\frac{1}{2}}$     | $a^{-1}$                      | $a^{-1}(1-a^2)^{\frac{1}{2}}$ | $(a^2-1)^{-\frac{1}{2}}$      |
| $\cosh x$               | $(1+a^2)^{\frac{1}{2}}$       | $a$                           | $(1-a^2)^{-\frac{1}{2}}$      | $a^{-1}(1+a^2)^{\frac{1}{2}}$ | $a^{-1}$                      | $a(a^2-1)^{-\frac{1}{2}}$     |
| $\tanh x$               | $a(1+a^2)^{-\frac{1}{2}}$     | $a^{-1}(a^2-1)^{\frac{1}{2}}$ | $a$                           | $(1+a^2)^{-\frac{1}{2}}$      | $(1-a^2)^{\frac{1}{2}}$       | $a^{-1}$                      |
| $\operatorname{csch} x$ | $a^{-1}$                      | $(a^2-1)^{-\frac{1}{2}}$      | $a^{-1}(1-a^2)^{\frac{1}{2}}$ | $a$                           | $a(1-a^2)^{-\frac{1}{2}}$     | $(a^2-1)^{\frac{1}{2}}$       |
| $\operatorname{sech} x$ | $(1+a^2)^{-\frac{1}{2}}$      | $a^{-1}$                      | $(1-a^2)^{\frac{1}{2}}$       | $a(1+a^2)^{-\frac{1}{2}}$     | $a$                           | $a^{-1}(a^2-1)^{\frac{1}{2}}$ |
| $\operatorname{coth} x$ | $a^{-1}(a^2+1)^{\frac{1}{2}}$ | $a(a^2-1)^{-\frac{1}{2}}$     | $a^{-1}$                      | $(1+a^2)^{\frac{1}{2}}$       | $(1-a^2)^{-\frac{1}{2}}$      | $a$                           |

Illustration: If  $\sinh x=a$ ,  $\operatorname{coth} x=a^{-1}(a^2+1)^{\frac{1}{2}}$   
 $\operatorname{arcsech} a=\operatorname{arccoth} (1-a^2)^{-\frac{1}{2}}$

4.5.61 Special Values of the Hyperbolic Functions

| $z$                     | 0        | $\frac{\pi}{2}i$ | $\pi i$  | $\frac{3\pi}{2}i$ | $\infty$ |
|-------------------------|----------|------------------|----------|-------------------|----------|
| $\sinh z$               | 0        | $i$              | 0        | $-i$              | $\infty$ |
| $\cosh z$               | 1        | 0                | -1       | 0                 | $\infty$ |
| $\tanh z$               | 0        | $\infty i$       | 0        | $-\infty i$       | 1        |
| $\operatorname{csch} z$ | $\infty$ | $-i$             | $\infty$ | $i$               | 0        |
| $\operatorname{sech} z$ | 1        | $\infty$         | -1       | $\infty$          | 0        |
| $\operatorname{coth} z$ | $\infty$ | 0                | $\infty$ | 0                 | 1        |

Series Expansions

4.5.62  $\sinh z = z + \frac{z^3}{3!} + \frac{z^5}{5!} + \frac{z^7}{7!} + \dots \quad (|z| < \infty)$

4.5.63  $\cosh z = 1 + \frac{z^2}{2!} + \frac{z^4}{4!} + \frac{z^6}{6!} + \dots \quad (|z| < \infty)$

4.5.64  $\tanh z = z - \frac{z^3}{3} + \frac{2}{15}z^5 - \frac{17}{315}z^7 + \dots + \frac{2^{2n}(2^{2n}-1)B_{2n}}{(2n)!}z^{2n-1} + \dots$   
 $(|z| < \frac{\pi}{2})$

4.5.65  $\operatorname{csch} z = \frac{1}{z} - \frac{z}{6} + \frac{7}{360}z^3 - \frac{31}{15120}z^5 + \dots - \frac{2(2^{2n-1}-1)B_{2n}}{(2n)!}z^{2n-1} + \dots$   
 $(|z| < \pi)$

4.5.66

$\operatorname{sech} z = 1 - \frac{z^2}{2} + \frac{5}{24}z^4 - \frac{61}{720}z^6 + \dots + \frac{E_{2n}}{(2n)!}z^{2n} + \dots$   
 $(|z| < \frac{\pi}{2})$

4.5.67

$\operatorname{coth} z = \frac{1}{z} + \frac{z}{3} - \frac{z^3}{45} + \frac{2}{945}z^5 - \dots + \frac{2^{2n}B_{2n}}{(2n)!}z^{2n-1} + \dots$   
 $(|z| < \pi)$

where  $B_n$  and  $E_n$  are the  $n$ th Bernoulli and Euler numbers, see chapter 23.

Infinite Products

4.5.68  $\sinh z = z \prod_{k=1}^{\infty} \left(1 + \frac{z^2}{k^2\pi^2}\right)$

4.5.69  $\cosh z = \prod_{k=1}^{\infty} \left[1 + \frac{4z^2}{(2k-1)^2\pi^2}\right]$

Continued Fraction

4.5.70  $\tanh z = \frac{z}{1 + \frac{z^2}{3 + \frac{z^2}{5 + \frac{z^2}{7 + \dots}}}}$   
 $(z \neq \frac{\pi}{2}i \pm n\pi i)$

Differentiation Formulas

4.5.71  $\frac{d}{dz} \sinh z = \cosh z$

4.5.72  $\frac{d}{dz} \cosh z = \sinh z$

4.5.73  $\frac{d}{dz} \tanh z = \operatorname{sech}^2 z$

4.5.74  $\frac{d}{dz} \operatorname{csch} z = -\operatorname{csch} z \operatorname{coth} z$



$$4.5.75 \quad \frac{d}{dz} \operatorname{sech} z = -\operatorname{sech} z \tanh z$$

$$4.5.76 \quad \frac{d}{dz} \operatorname{coth} z = -\operatorname{csch}^2 z$$

#### Integration Formulas

$$4.5.77 \quad \int \sinh z \, dz = \cosh z$$

$$4.5.78 \quad \int \cosh z \, dz = \sinh z$$

$$4.5.79 \quad \int \tanh z \, dz = \ln \cosh z$$

$$4.5.80 \quad \int \operatorname{csch} z \, dz = \ln \tanh \frac{z}{2}$$

$$4.5.81 \quad \int \operatorname{sech} z \, dz = \arctan (\sinh z)$$

$$4.5.82 \quad \int \operatorname{coth} z \, dz = \ln \sinh z$$

$$4.5.83 \quad \int z^n \sinh z \, dz = z^n \cosh z - n \int z^{n-1} \cosh z \, dz$$

$$4.5.84 \quad \int z^n \cosh z \, dz = z^n \sinh z - n \int z^{n-1} \sinh z \, dz$$

$$4.5.85 \quad \int \sinh^m z \cosh^n z \, dz = \frac{1}{m+n} \sinh^{m+1} z \cosh^{n-1} z \\ + \frac{n-1}{m+n} \int \sinh^m z \cosh^{n-2} z \, dz \\ = \frac{1}{m+n} \sinh^{m-1} z \cosh^{n+1} z \\ - \frac{m-1}{m+n} \int \sinh^{m-2} z \cosh^n z \, dz \quad (m+n \neq 0)$$

$$4.5.86 \quad \int \frac{dz}{\sinh^m z \cosh^n z} = \frac{-1}{m-1} \frac{1}{\sinh^{m-1} z \cosh^{n-1} z} \\ - \frac{m+n-2}{m-1} \int \frac{dz}{\sinh^{m-2} z \cosh^n z} \quad (m \neq 1) \\ = \frac{1}{n-1} \frac{1}{\sinh^{m-1} z \cosh^{n-1} z} \\ + \frac{m+n-2}{n-1} \int \frac{dz}{\sinh^m z \cosh^{n-2} z} \quad (n \neq 1)$$

#### 4.5.87

$$\int \tanh^n z \, dz = -\frac{\tanh^{n-1} z}{n-1} + \int \tanh^{n-2} z \, dz \quad (n \neq 1)$$

#### 4.5.88

$$\int \operatorname{coth}^n z \, dz = -\frac{\operatorname{coth}^{n-1} z}{n-1} + \int \operatorname{coth}^{n-2} z \, dz \quad (n \neq 1)$$

(See chapters 5 and 7 for other integrals involving hyperbolic functions.)

### 4.6. Inverse Hyperbolic Functions

#### Definitions

$$4.6.1 \quad \operatorname{arsinh} z = \int_0^z \frac{dt}{(1+t^2)^{1/2}} \quad (z = x+iy)$$

$$4.6.2 \quad \operatorname{arcosh} z = \int_1^z \frac{dt}{(t^2-1)^{1/2}}$$

$$4.6.3 \quad \operatorname{artanh} z = \int_0^z \frac{dt}{1-t^2}$$

The paths of integration must not cross the following cuts.

4.6.1 imaginary axis from  $-i\infty$  to  $-i$  and  $i$  to  $i\infty$

4.6.2 real axis from  $-\infty$  to  $+1$

4.6.3 real axis from  $-\infty$  to  $-1$  and  $+1$  to  $+\infty$

Inverse hyperbolic functions are also written  $\sinh^{-1} z$ ,  $\operatorname{arsinh} z$ ,  $\mathcal{A}r \sinh z$ , etc.

$$4.6.4 \quad \operatorname{arcsch} z = \operatorname{arsinh} 1/z$$

$$4.6.5 \quad \operatorname{arcsech} z = \operatorname{arcosh} 1/z$$

$$4.6.6 \quad \operatorname{arcoth} z = \operatorname{artanh} 1/z$$

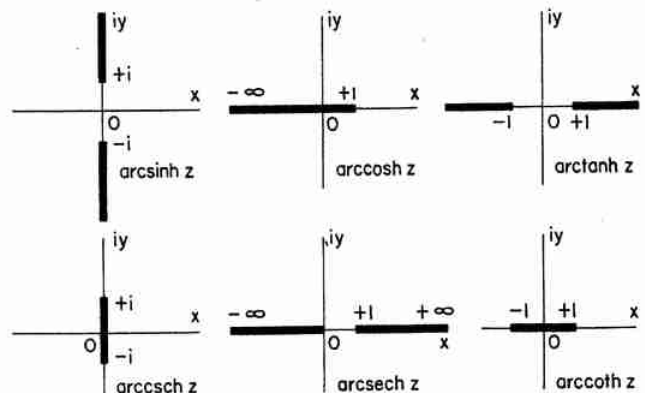

FIGURE 4.7. Branch cuts for inverse hyperbolic functions.

4.6.7  $\operatorname{arctanh} z = \operatorname{arccoth} z \pm \frac{1}{2}\pi i$   
 (see 4.5.60) (according as  $\Im z \geq 0$ )

**Fundamental Property**

The general solutions of the equations

$$z = \sinh t$$

$$z = \cosh t$$

$$z = \tanh t$$

are respectively

4.6.8  $t = \operatorname{Arcsinh} z = (-1)^k \operatorname{arsinh} z + k\pi i$

4.6.9  $t = \operatorname{Arccosh} z = \pm \operatorname{arccosh} z + 2k\pi i$

4.6.10  $t = \operatorname{Arctanh} z = \operatorname{arctanh} z + k\pi i$   
 ( $k$ , integer)

**Functions of Negative Arguments**

4.6.11  $\operatorname{arsinh} (-z) = -\operatorname{arsinh} z$

\*4.6.12  $\operatorname{arccosh} (-z) = \pi i - \operatorname{arccosh} z$

4.6.13  $\operatorname{arctanh} (-z) = -\operatorname{arctanh} z$

**Relation to Inverse Circular Functions** (see 4.4.20 to 4.4.25)

Hyperbolic identities can be derived from trigonometric identities by replacing  $z$  by  $iz$ .

4.6.14  $\operatorname{Arcsinh} z = -i \operatorname{Arcsin} iz$

4.6.15  $\operatorname{Arccosh} z = \pm i \operatorname{Arccos} z$

4.6.16  $\operatorname{Arctanh} z = -i \operatorname{Arctan} iz$

4.6.17  $\operatorname{Arccsch} z = i \operatorname{Arccsc} iz$

4.6.18  $\operatorname{Arcsech} z = \pm i \operatorname{Arcsec} z$

4.6.19  $\operatorname{Arcoth} z = i \operatorname{Arccot} iz$

**Logarithmic Representations**

4.6.20  $\operatorname{arsinh} x = \ln [x + (x^2 + 1)^{\frac{1}{2}}]$

4.6.21  $\operatorname{arccosh} x = \ln [x + (x^2 - 1)^{\frac{1}{2}}]$  ( $x \geq 1$ )

4.6.22  $\operatorname{arctanh} x = \frac{1}{2} \ln \frac{1+x}{1-x}$  ( $0 \leq x^2 < 1$ )

4.6.23  $\operatorname{arccsch} x = \ln \left[ \frac{1}{x} + \left( \frac{1}{x^2} + 1 \right)^{\frac{1}{2}} \right]$  ( $x \neq 0$ )

4.6.24  $\operatorname{arcsech} x = \ln \left[ \frac{1}{x} + \left( \frac{1}{x^2} - 1 \right)^{\frac{1}{2}} \right]$  ( $0 < x \leq 1$ )

4.6.25  $\operatorname{arccoth} x = \frac{1}{2} \ln \frac{x+1}{x-1}$  ( $x^2 > 1$ )

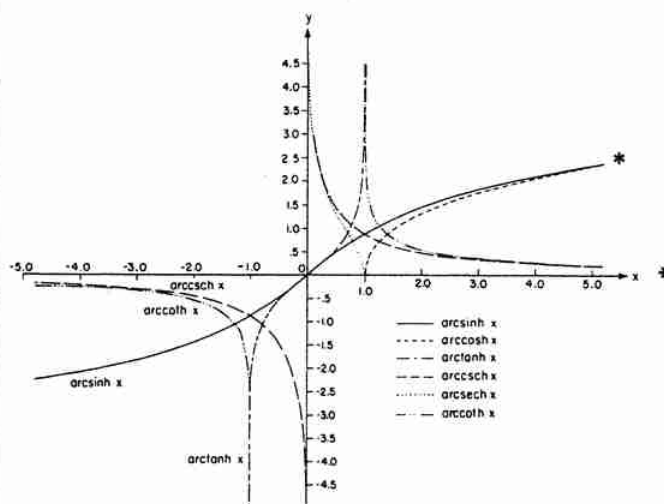

FIGURE 4.8. Inverse hyperbolic functions.

**Addition and Subtraction of Two Inverse Hyperbolic Functions**

4.6.26

$$\operatorname{Arcsinh} z_1 \pm \operatorname{Arcsinh} z_2 = \operatorname{Arcsinh} [z_1(1+z_2^2)^{\frac{1}{2}} \pm z_2(1+z_1^2)^{\frac{1}{2}}]$$

4.6.27

$$\operatorname{Arccosh} z_1 \pm \operatorname{Arccosh} z_2 = \operatorname{Arccosh} \{ z_1 z_2 \pm [(z_1^2 - 1)(z_2^2 - 1)]^{\frac{1}{2}} \}$$

4.6.28

$$\operatorname{Arctanh} z_1 \pm \operatorname{Arctanh} z_2 = \operatorname{Arctanh} \left( \frac{z_1 \pm z_2}{1 \pm z_1 z_2} \right)$$

4.6.29

$$\begin{aligned} \operatorname{Arcsinh} z_1 \pm \operatorname{Arccosh} z_2 &= \operatorname{Arcsinh} \{ z_1 z_2 \pm [(1+z_1^2)(z_2^2-1)]^{\frac{1}{2}} \} \\ &= \operatorname{Arccosh} [z_2(1+z_1^2)^{\frac{1}{2}} \pm z_1(z_2^2-1)^{\frac{1}{2}}] \end{aligned}$$

4.6.30

$$\begin{aligned} \operatorname{Arctanh} z_1 \pm \operatorname{Arcoth} z_2 &= \operatorname{Arctanh} \left( \frac{z_1 z_2 \pm 1}{z_2 \pm z_1} \right) \\ &= \operatorname{Arcoth} \left( \frac{z_2 \pm z_1}{z_1 z_2 \pm 1} \right) \end{aligned}$$

\*See page 11.

## Series Expansions

4.6.31

$$\operatorname{arcsinh} z = z - \frac{1}{2 \cdot 3} z^3 + \frac{1 \cdot 3}{2 \cdot 4 \cdot 5} z^5 - \frac{1 \cdot 3 \cdot 5}{2 \cdot 4 \cdot 6 \cdot 7} z^7 + \dots$$

$$(|z| < 1)$$

$$= \ln 2z + \frac{1}{2 \cdot 2z^2} - \frac{1 \cdot 3}{2 \cdot 4 \cdot 4z^4} + \frac{1 \cdot 3 \cdot 5}{2 \cdot 4 \cdot 6 \cdot 6z^6} - \dots$$

$$(|z| > 1)$$

4.6.32

$$\operatorname{arccosh} z = \ln 2z - \frac{1}{2 \cdot 2z^2} - \frac{1 \cdot 3}{2 \cdot 4 \cdot 4z^4} - \frac{1 \cdot 3 \cdot 5}{2 \cdot 4 \cdot 6 \cdot 6z^6} - \dots$$

$$(|z| > 1)$$

$$4.6.33 \quad \operatorname{arctanh} z = z + \frac{z^3}{3} + \frac{z^5}{5} + \frac{z^7}{7} + \dots \quad (|z| < 1)$$

$$4.6.34 \quad \operatorname{arcoth} z = \frac{1}{z} + \frac{1}{3z^3} + \frac{1}{5z^5} + \frac{1}{7z^7} + \dots$$

$$(|z| > 1)$$

## Continued Fractions

$$4.6.35 \quad \operatorname{arctanh} z = \frac{z \cdot z^2 \cdot 4z^2 \cdot 9z^2}{1 - 3 - 5 - 7 - \dots}$$

( $z$  in the cut plane of Figure 4.7.)

4.6.36

$$\frac{\operatorname{arcsinh} z}{\sqrt{1+z^2}} = \frac{z}{1+} \frac{1 \cdot 2z^2}{3+} \frac{1 \cdot 2z^2 \cdot 3 \cdot 4z^2}{5+} \frac{3 \cdot 4z^2 \cdot 3 \cdot 4z^2}{7+} \frac{3 \cdot 4z^2}{9+} \dots$$

## Differentiation Formulas

$$4.6.37 \quad \frac{d}{dz} \operatorname{arcsinh} z = (1+z^2)^{-\frac{1}{2}}$$

$$4.6.38 \quad \frac{d}{dz} \operatorname{arccosh} z = (z^2-1)^{-\frac{1}{2}}$$

$$4.6.39 \quad \frac{d}{dz} \operatorname{arctanh} z = (1-z^2)^{-1}$$

$$4.6.40 \quad \frac{d}{dz} \operatorname{arcsch} z = \mp \frac{1}{z(1+z^2)^{\frac{1}{2}}}$$

(according as  $\Re z \geq 0$ )

$$4.6.41 \quad \frac{d}{dz} \operatorname{arcsech} z = \mp \frac{1}{z(1-z^2)^{\frac{1}{2}}}$$

$$4.6.42 \quad \frac{d}{dz} \operatorname{arcoth} z = (1-z^2)^{-1}$$

## Integration Formulas

$$4.6.43 \quad \int \operatorname{arcsinh} z \, dz = z \operatorname{arcsinh} z - (1+z^2)^{\frac{1}{2}}$$

$$4.6.44 \quad \int \operatorname{arccosh} z \, dz = z \operatorname{arccosh} z - (z^2-1)^{\frac{1}{2}}$$

$$4.6.45 \quad \int \operatorname{arctanh} z \, dz = z \operatorname{arctanh} z + \frac{1}{2} \ln(1-z^2)$$

$$4.6.46 \quad \int \operatorname{arcsch} z \, dz = z \operatorname{arcsch} z \pm \operatorname{arcsinh} z \quad *$$

(according as  $\Re z \geq 0$ )

$$4.6.47 \quad \int \operatorname{arcsech} z \, dz = z \operatorname{arcsech} z \pm \operatorname{arcsin} z \quad *$$

$$4.6.48 \quad \int \operatorname{arcoth} z \, dz = z \operatorname{arcoth} z + \frac{1}{2} \ln(z^2-1)$$

$$4.6.49 \quad \int z \operatorname{arcsinh} z \, dz = \frac{2z^2+1}{4} \operatorname{arcsinh} z - \frac{z}{4} (z^2+1)^{\frac{1}{2}}$$

$$4.6.50 \quad \int z^n \operatorname{arcsinh} z \, dz = \frac{z^{n+1}}{n+1} \operatorname{arcsinh} z - \frac{1}{n+1} \int \frac{z^{n+1}}{(1+z^2)^{\frac{1}{2}}} dz$$

( $n \neq -1$ )

$$4.6.51 \quad \int z \operatorname{arccosh} z \, dz = \frac{2z^2-1}{4} \operatorname{arccosh} z - \frac{z}{4} (z^2-1)^{\frac{1}{2}}$$

$$4.6.52 \quad \int z^n \operatorname{arccosh} z \, dz = \frac{z^{n+1}}{n+1} \operatorname{arccosh} z - \frac{1}{n+1} \int \frac{z^{n+1}}{(z^2-1)^{\frac{1}{2}}} dz$$

( $n \neq -1$ )

$$4.6.53 \quad \int z \operatorname{arctanh} z \, dz = \frac{z^2-1}{2} \operatorname{arctanh} z + \frac{z}{2}$$

$$4.6.54 \quad \int z^n \operatorname{arctanh} z \, dz = \frac{z^{n+1}}{n+1} \operatorname{arctanh} z - \frac{1}{n+1} \int \frac{z^{n+1}}{1-z^2} dz$$

( $n \neq -1$ )

$$4.6.55 \quad \int z \operatorname{arcsch} z \, dz = \frac{z^2}{2} \operatorname{arcsch} z \pm \frac{1}{2} (1+z^2)^{\frac{1}{2}} \quad *$$

(according as  $\Re z \geq 0$ )

$$4.6.56 \quad \int z^n \operatorname{arcsech} z \, dz = \frac{z^{n+1}}{n+1} \operatorname{arcsech} z \pm \frac{1}{n+1} \int \frac{z^n}{(z^2+1)^{\frac{1}{2}}} dz \quad *$$

( $n \neq -1$ )

\*See page II.

4.6.57  $\int z \operatorname{arcsech} z \, dz = \frac{z^2}{2} \operatorname{arcsech} z \mp \frac{1}{2} (1-z^2)^{\frac{1}{2}}$   
 (according as  $\mathcal{R}z \geq 0$ )

4.6.58  $\int z^n \operatorname{arcsech} z \, dz = \frac{z^{n+1}}{n+1} \operatorname{arcsech} z \pm \frac{1}{n+1} \int \frac{z^n}{(1-z^2)^{\frac{1}{2}}} dz$   
 ( $n \neq -1$ )

4.6.59  $\int z \operatorname{arccoth} z \, dz = \frac{z^2-1}{2} \operatorname{arccoth} z + \frac{z}{2}$

4.6.60  $\int z^n \operatorname{arccoth} z \, dz = \frac{z^{n+1}}{n+1} \operatorname{arccoth} z + \frac{1}{n+1} \int \frac{z^{n+1}}{z^2-1} dz$   
 ( $n \neq -1$ )

**Numerical Methods**

**4.7. Use and Extension of the Tables**

NOTE: In the examples given it is assumed that the arguments are exact.

**Example 1. Computation of Common Logarithms.**

To compute common logarithms, the number must be expressed in the form  $x \cdot 10^q$ , ( $1 \leq x < 10$ ,  $-\infty \leq q \leq \infty$ ). The common logarithm of  $x \cdot 10^q$  consists of an integral part which is called the characteristic and a decimal part which is called the mantissa. Table 4.1 gives the common logarithm of  $x$ .

| $x$     | $x \cdot 10^q$        | $\log_{10} x \cdot 10^q$                 |
|---------|-----------------------|--|
| .009836 | $9.836 \cdot 10^{-3}$ | $\bar{3}.99281 \, 85 = (-2.00718 \, 15)$ |
| .09836  | $9.836 \cdot 10^{-2}$ | $\bar{2}.99281 \, 85 = (-1.00718 \, 15)$ |
| .9836   | $9.836 \cdot 10^{-1}$ | $\bar{1}.99281 \, 85 = (-0.00718 \, 15)$ |
| 9.836   | $9.836 \cdot 10^0$    | 0.99281 85                               |
| 98.36   | $9.836 \cdot 10^1$    | 1.99281 85                               |
| 983.6   | $9.836 \cdot 10^2$    | 2.99281 85                               |

Interpolation in Table 4.1 between 983 and 984 gives .99281 85 as the mantissa of 9836.

Note that  $\bar{3}.99281 \, 85 = -3 + .99281 \, 85$ . When  $q$  is negative the common logarithm can be expressed in the alternative forms

$\log_{10} (.009836) = \bar{3}.99281 \, 85 = 7.99281 \, 85 - 10$   
 $= -2.00718 \, 15.$

The last form is convenient for conversion from common logarithms to natural logarithms.

The inverse of  $\log_{10} x$  is called the antilogarithm of  $x$ , and is written  $\operatorname{antilog} x$  or  $\log^{-1} x$ . The logarithm of the reciprocal of a number is called the cologarithm, written  $\operatorname{colog}$ .

\*See page 11.

**Example 2.**

Compute  $x^{-3/4}$  for  $x=9.19826$  to 10D using the Table of Common Logarithms.

From Table 4.1, four-point Lagrangian interpolation gives  $\log_{10} (9.19826) = .96370 \, 56812$ . Then,  $-\frac{3}{4} \log_{10} (x) = -.72277 \, 92609 = 9.27722 \, 07391 - 10$ .

Linear inverse interpolation in Table 4.1 yields  $\operatorname{antilog} (\bar{1}.27722) = .18933$ . For 10 place accuracy subtabulation with 4-point Lagrangian interpolants produces the table

| $N$    | $\log_{10} N$ | $\Delta$ | $\Delta^2$ |
|--------|---------------|----------|------------|
| .18933 | .27721 94350  | 2 29379  |            |
| .18934 | .27724 23729  | 2 29366  | -13        |
| .18935 | .27726 53095  |          |            |

By linear inverse interpolation

$x^{-3/4} = .18933 \, 05685.$

**Example 3.**

Convert  $\log_{10} x$  to  $\ln x$  for  $x = .009836$ .

Using 4.1.23 and Table 4.1,  $\ln (.009836) = \ln 10 \log_{10} (.009836) = 2.30258 \, 5093 (-2.00718 \, 15) = -4.62170 \, 62$ .

**Example 4.**

Compute  $\ln x$  for  $x = .00278$  to 6D.

Using 4.1.7, 4.1.11 and Table 4.2,  $\ln (.00278) = \ln (.278 \cdot 10^{-2}) = \ln (.278) - 2 \ln 10 = -5.885304$ .

Linear interpolation between  $x = .002$  and  $x = .003$  would give  $\ln(.00278) = -5.898$ . To obtain 5 decimal place accuracy with linear interpolation it is necessary that  $x > .175$ .

**Example 5.**

Compute  $\ln x$  for  $x = 1131.718$  to 8D.

Using 4.1.7, 4.1.11 and Table 4.2

$\ln 1131.718 = \ln \left( \frac{1131.718}{1131} \cdot 1131 \right)$   
 $= \ln \frac{1131.718}{1131} + \ln 1.131 + \ln 10^3$   
 $= \ln (1.00063 \, 4836) + \ln 1.131 + 3 \ln 10.$

**Example 25.**

Compute  $\operatorname{arcsec} 2.8$  to 5D.  
Using 4.3.45 and Table 4.14

$$\begin{aligned}\operatorname{arcsec} z &= \arcsin \frac{(z^2-1)^{\frac{1}{2}}}{z} \\ \operatorname{arcsec} 2.8 &= \arcsin \frac{[(2.8)^2-1]^{\frac{1}{2}}}{2.8} \\ &= \arcsin .93404\ 97735 \\ &= 1.20559\end{aligned}$$

or using 4.3.45 and Table 4.14

$$\begin{aligned}\operatorname{arcsec} z &= \arctan (z^2-1)^{\frac{1}{2}} \\ \operatorname{arcsec} 2.8 &= \arctan 2.61533\ 9366 \\ &= \frac{\pi}{2} - \arctan .38235\ 95564, \\ &\hspace{10em} \text{from 4.4.3 and 4.4.8} \\ &= 1.570796 - .365207 \\ &= 1.20559.\end{aligned}$$

**Example 26.**

Compute  $\operatorname{arctanh} x$  for  $x=.96035$  to 6D.  
From 4.6.22 and Table 4.2

$$\begin{aligned}\operatorname{arctanh} .96035 &= \frac{1}{2} \ln \frac{1+.96035}{1-.96035} = \frac{1}{2} \ln \frac{1.96035}{.03965} \\ &= \frac{1}{2} \ln 49.44136\ 191 \\ &= \frac{1}{2}(3.90078\ 7359) = 1.950394.\end{aligned}$$

**Example 27.**

Compute  $\operatorname{arccosh} x$  for  $x=1.5368$  to 6D.  
Using Table 4.17

$$\begin{aligned}\frac{\operatorname{arccosh} x}{(x^2-1)^{\frac{1}{2}}} &= \frac{\operatorname{arccosh} 1.5368}{[(1.5368)^2-1]^{\frac{1}{2}}} = .852346 \\ \operatorname{arccosh} 1.5368 &= (.852346)(1.361754)^{\frac{1}{2}} \\ &= (.852346)(1.166942) \\ &= .994638.\end{aligned}$$

**Example 28.**

Compute  $\operatorname{arccosh} x$  for  $x=31.2$  to 5D.  
Using Tables 4.2 and 4.17 with  $1/x=1/31.2$   
 $=.03205\ 128205$

$$\begin{aligned}\operatorname{arccosh} 31.2 - \ln 31.2 &= .692886 \\ \operatorname{arccosh} 31.2 &= .692886 + 3.440418 = 4.13330.\end{aligned}$$

**References****Texts**

- [4.1] B. Carlson, M. Goldstein, Rational approximation of functions, Los Alamos Scientific Laboratory LA-1943 (Los Alamos, N. Mex., 1955).  
[4.2] C. W. Clenshaw, Polynomial approximations to elementary functions, *Math. Tables Aids Comp.* 8, 143-147 (1954).  
[4.3] C. W. Clenshaw, A note on the summation of Chebyshev series, *Math. Tables Aids Comp.* 9, 118-120 (1955).  
[4.4] G. H. Hardy, A course of pure mathematics, 9th ed. (Cambridge Univ. Press, Cambridge, England, and The Macmillan Co., New York, N.Y., 1947).  
[4.5] C. Hastings, Jr., Approximations for digital computers (Princeton Univ. Press, Princeton, N.J., 1955).  
[4.6] C. Hastings, Jr., Note 143, *Math. Tables Aids Comp.* 6, 68 (1953).  
[4.7] E. W. Hobson, A treatise on plane trigonometry, 4th ed. (Cambridge Univ. Press, Cambridge, England, 1918).  
[4.8] H. S. Wall, Analytic theory of continued fractions (D. Van Nostrand Co., Inc., New York, N.Y., 1948).

**Tables**

- [4.9] E. P. Adams, Smithsonian mathematical formulae and tables of elliptic functions, 3d reprint (The Smithsonian Institution, Washington, D.C., 1957).  
[4.10] H. Andoyer, Nouvelles tables trigonométriques fondamentales (Hermann et fils, Paris, France, 1916).  
[4.11] British Association for the Advancement of Science, Mathematical Tables, vol. I. Circular and hyperbolic functions, exponential, sine and cosine integrals, factorial function and allied functions, Hermitian probability functions, 3d ed. (Cambridge Univ. Press, Cambridge, England, 1951).  
[4.12] Chemical Rubber Company, Standard mathematical tables, 12th ed. (Chemical Rubber Publ. Co., Cleveland, Ohio, 1959).  
[4.13] L. J. Comrie, Chambers' six-figure mathematical tables, vol. 2 (W. R. Chambers, Ltd., London, England, 1949).  
[4.14] H. B. Dwight, Tables of integrals and other mathematical data, 3d rev. ed. (The Macmillan Co., New York, N.Y., 1957).  
[4.15] W. Gröbner and N. Hofreiter, Integraltafel, unbestimmte und bestimmte Integrale (Springer-Verlag, Wien und Innsbruck, Austria, 1949-1950).  
[4.16] Harvard Computation Laboratory, Tables of the function  $\arcsin z$  (Harvard Univ. Press, Cambridge, Mass., 1956).  $z=x+iy$ ,  $0 \leq x \leq 475$ ,  $0 \leq y \leq 475$ , 6D, varying intervals.  
[4.17] Harvard Computation Laboratory, Tables of inverse hyperbolic functions (Harvard Univ. Press, Cambridge, Mass., 1949).  $\operatorname{arctanh} x$ ,  $0 \leq x < 1$ ;  $\operatorname{arcsinh} x$ ,  $0 \leq x < 3.5$ ;  $\operatorname{arccosh} x$ ,  $1 \leq x < 3.5$ ;  $\operatorname{arcsinh} x$ ,  $\operatorname{arccosh} x$ ,  $3.5 \leq x \leq 22980$ , 9D, varying intervals.  
[4.18] National Bureau of Standards, Tables of  $10^x$ , Applied Math. Series 27 (U.S. Government Printing Office, Washington, D.C., 1953).  $x=0(.00001)1$ , 10 D. Radix table of  $10^{n \cdot 10^{-p}}$ ,  $n=1(1)999$ ,  $p=3(3)15$ , 15D.

- [4.19] National Bureau of Standards, Table of natural logarithms for arguments between zero and five to sixteen decimal places, 2d ed., Applied Math. Series 31 (U.S. Government Printing Office, Washington, D.C., 1953).  $x=0(.0001)5$ , 16 D.
- [4.20] National Bureau of Standards, Tables of the exponential function  $e^x$ , 3d ed., Applied Math. Series 14 (U.S. Government Printing Office, Washington, D.C., 1951).  $x=-2.4999(.0001)$  .9999, 18D,  $x=1(.0001)$  2.4999, 15D,  $x=2.5(.001)4.999$ , 15D,  $x=5(.01)9.99$ , 12D,  $x=-.000099(.000001)$  .000099, 18D,  $x=-100(1)100$ , 19S,  $x=-9 \times 10^{-n}(10^{-n})9 \times 10^{-n}$ ,  $n=10, 9, 8, 7$ , 18D; values of  $e$  and  $1/e$ , 2556D.
- [4.21] National Bureau of Standards, Table of the descending exponential,  $x=2.5$  to  $x=10$ , Applied Math. Series 46 (U.S. Government Printing Office, Washington, D.C., 1955).  $x=2.5(.001)10$ , 20D.
- [4.22] National Bureau of Standards, Tables of sines and cosines for radian arguments, 2d ed., Applied Math. Series 43 (U.S. Government Printing Office, Washington, D.C., 1955).  $\sin x$ ,  $\cos x$ ,  $x=0(.001)25.2$ , 0(1)100, 8D,  $x=10^{-n}(10^{-n})9 \times 10^{-n}$ ,  $n=5, 4, 3, 2, 1$ , 15D,  $x=0(.00001)$  .01, 12D.
- [4.23] National Bureau of Standards, Tables of circular and hyperbolic sines and cosines for radian arguments, 2d ed., Applied Math. Series 36 (U.S. Government Printing Office, Washington, D.C., 1953).  $\sin x$ ,  $\cos x$ ,  $\sinh x$ ,  $\cosh x$ ,  $x=0(.0001)$  1.9999, 0(.1)10, 9D.
- [4.24] National Bureau of Standards, Table of circular and hyperbolic tangents and cotangents for radian arguments, 2d printing (Columbia Univ. Press, New York, N.Y., 1947).  $\tan x$ ,  $\cot x$ ,  $\tanh x$ ,  $\coth x$ ,  $x=0(.0001)2$ , 8D or 8S,  $x=0(.1)10$ , 10D.
- [4.25] National Bureau of Standards, Table of sines and cosines to fifteen decimal places at hundredths of a degree, Applied Math. Series 5 (U.S. Government Printing Office, Washington, D.C., 1949).  $\sin x$ ,  $\cos x$ ,  $x=0^\circ(.01^\circ)90^\circ$ , 15D; supplementary table of  $\sin x$ ,  $\cos x$ ,  $x=1^\circ(1^\circ)89^\circ$ , 30 D.
- [4.26] National Bureau of Standards, Table of secants and cosecants to nine significant figures at hundredths of a degree, Applied Math. Series 40 (U.S. Government Printing Office, Washington, D.C., 1954).
- [4.27] National Bureau of Standards, Tables of functions and of zeros of functions, Collected short tables of the Computation Laboratory, Applied Math. Series 37 (U.S. Government Printing Office, Washington, D.C., 1954).
- [4.28] National Bureau of Standards, Table of arcsin  $x$  (Columbia Univ. Press, New York, N.Y., 1945). arcsin  $x$ ,  $x=0(.0001).989(.00001)1$ , 12D; auxiliary table of  $f(v)=\{\frac{1}{2}\pi - \arcsin(1-v)\}/(2v)^{1/2}$ ,  $v=0(.00001).0005$ , 13D.
- [4.29] National Bureau of Standards, Tables of arctan  $x$ , 2d ed., Applied Math. Series 26 (U.S. Government Printing Office, Washington D.C., 1953).  $x=0(.001)7(.01)50(.1)300(.1)2000(.1)10000$ , 12D.
- [4.30] National Bureau of Standards, Table of hyperbolic sines and cosines,  $x=2$  to  $x=10$ , Applied Math. Series 45 (U.S. Government Printing Office, Washington, D.C., 1955).  $x=2(.001)10$ , 9S.
- [4.31] B. O. Peirce, A short table of integrals, 4th ed. (Ginn and Co., Boston, Mass., 1956).
- [4.32] J. Peters, Ten-place logarithm table, vols. 1, 2 (together with an appendix of mathematical tables), (Berlin, 1922; rev. ed., Frederick Ungar Publ. Co., New York, N.Y., 1957).
- [4.33] J. Peters, Seven-place values of trigonometric functions for every thousandth of a degree (Berlin-Friedenau, 1918; D. Van Nostrand Co., Inc., New York, N.Y., 1942).
- [4.34] L. W. Pollak, Rechentafeln zur harmonischen Analyse (Johann Ambrosius Barth, Leipzig, Germany, 1926).
- [4.35] A. J. Thompson, Standard table of logarithms to twenty decimal places, Tracts for Computers, No. 22 (Cambridge Univ. Press, Cambridge, England, and New York, N.Y., 1952).
- [4.36] J. Todd, Table of arctangents of rational numbers, NBS Applied Math. Series 11 (U.S. Government Printing Office, Washington, D.C., 1951). arctan  $m/n$  and arccot  $m/n$ ,  $0 < m < n \leq 100$ , 12D; reductions of arctan  $m/n$ ,  $0 < m < n \leq 100$ ; reductions of arctan  $n$  for reducible  $n \leq 2089$ .
- [4.37] U.S. Department of Commerce, Coast and Geodetic Survey, Natural sines and cosines to eight decimal places, Special Publication No. 231 (U.S. Government Printing Office, Washington, D.C., 1942).
- [4.38] C. E. Van Orstrand, Tables of the exponential\* function and of the circular sine and cosine to radian arguments, Memoirs of the National Academy of Sciences 14, 5th Memoir (U.S. Government Printing Office, Washington, D.C., 1921).
- [4.39] B. V. Vega, Logarithmic tables of numbers and trigonometrical functions (G. E. Stechert & Co., New York, N.Y., 1905);  $\log_{10} x$ ,  $x=1(1)100000$ ; logarithms of the trigonometrical functions for every ten seconds.

\*See page 11.



# 5. Exponential Integral and Related Functions

WALTER GAUTSCHI<sup>1</sup> AND WILLIAM F. CAHILL<sup>2</sup>

## Contents

|   | Page |
|---|------|
| <b>Mathematical Properties</b> . . . . .  | 228  |
| <b>5.1. Exponential Integral</b> . . . . .  | 228  |
| <b>5.2. Sine and Cosine Integrals</b> . . . . .   | 231  |
| <b>Numerical Methods</b> . . . . .  | 233  |
| <b>5.3. Use and Extension of the Tables</b> . . . . .   | 233  |
| <b>References</b> . . . . .   | 235  |
| <b>Table 5.1. Sine, Cosine and Exponential Integrals (<math>0 \leq x \leq 10</math>)</b> . . . . .                            | 238  |
| $x^{-1}\text{Si}(x)$ , $x^{-2}[\text{Ci}(x) - \ln x - \gamma]$  |      |
| $x^{-1}[\text{Ei}(x) - \ln x - \gamma]$ , $x^{-1}[E_1(x) + \ln x + \gamma]$ , $x=0(.01).5$ , 10S                              |      |
| $\text{Si}(x)$ , $\text{Ci}(x)$ , 10D; $\text{Ei}(x)$ , $E_1(x)$ , 9D; $x=.5(.01)2$   |      |
| $\text{Si}(x)$ , $\text{Ci}(x)$ , 10D; $xe^{-x}\text{Ei}(x)$ , $xe^x E_1(x)$ , 9D; $x=2(.1)10$                                |      |
| <b>Table 5.2. Sine, Cosine and Exponential Integrals for Large Arguments</b><br>( $10 \leq x \leq \infty$ ) . . . . .         | 243  |
| $xf(x)$ , 9D; $x^2g(x)$ , 7D; $xe^{-x}\text{Ei}(x)$ , 8D; $xe^xE_1(x)$ , 10D  |      |
| $f(x) = -\text{si}(x) \cos x + \text{Ci}(x) \sin x$ , $g(x) = -\text{si}(x) \sin x - \text{Ci}(x) \cos x$                     |      |
| $x^{-1}=.1(-.005)0$   |      |
| <b>Table 5.3. Sine and Cosine Integrals for Arguments <math>\pi x</math> (<math>0 \leq x \leq 10</math>)</b> . . . . .        | 244  |
| $\text{Si}(\pi x)$ , $\text{Cin}(\pi x)$ , $x=0(.1)10$ , 7D   |      |
| <b>Table 5.4. Exponential Integrals <math>E_n(x)</math> (<math>0 \leq x \leq 2</math>)</b> . . . . .                          | 245  |
| $E_2(x) - x \ln x$ , $E_n(x)$ , $n=3, 4, 10, 20$ , $x=0(.01).5$   |      |
| $E_n(x)$ , $n=2, 3, 4, 10, 20$ , $x=.5(.01)2$ , 7D  |      |
| <b>Table 5.5. Exponential Integrals <math>E_n(x)</math> for Large Arguments (<math>2 \leq x \leq \infty</math>)</b> . . . . . | 248  |
| $(x+n)e^xE_n(x)$ , $n=2, 3, 4, 10, 20$ , $x^{-1}=.5(-.05).1(-.01)0$ , 5D  |      |
| <b>Table 5.6. Exponential Integral for Complex Arguments (<math> z  &lt; 29</math>)</b> . . . . .                             | 249  |
| $ze^zE_1(z)$ , $z=x+iy$ , $x=-19(1)20$ , $y=0(1)20$ , 6D  |      |
| <b>Table 5.7. Exponential Integral for Small Complex Arguments (<math> z  &lt; 5</math>)</b> . . . . .                        | 251  |
| $e^zE_1(z)$ , $z=x+iy$ , $x=-4(.5)-2$ , $y=0(.2)1$ , 6D   |      |
| $E_1(z) + \ln z$ , $z=x+iy$ , $x=-2(.5)2.5$ , $y=0(.2)1$ , 6D   |      |

The authors acknowledge the assistance of David S. Liepman in the preparation and checking of the tables, Robert L. Durrah for the computation of **Table 5.2**, and Alfred E. Beam for the computation of **Table 5.6**.

<sup>1</sup> Guest worker, National Bureau of Standards, from the American University. (Presently Purdue University.)

<sup>2</sup> National Bureau of Standards. (Presently NASA.)

# 5. Exponential Integral and Related Functions

## Mathematical Properties

### 5.1. Exponential Integral

#### Definitions

$$5.1.1 \quad E_1(z) = \int_z^\infty \frac{e^{-t}}{t} dt \quad (|\arg z| < \pi)$$

$$5.1.2 \quad \text{Ei}(x) = -\int_{-x}^\infty \frac{e^{-t}}{t} dt = \int_{-\infty}^x \frac{e^t}{t} dt \quad (x > 0)$$

$$5.1.3 \quad \text{li}(x) = \int_0^x \frac{dt}{\ln t} = \text{Ei}(\ln x) \quad (x > 1)$$

#### 5.1.4

$$E_n(z) = \int_1^\infty \frac{e^{-zt}}{t^n} dt \quad (n=0, 1, 2, \dots; \Re z > 0)$$

#### 5.1.5

$$\alpha_n(z) = \int_1^\infty t^n e^{-zt} dt \quad (n=0, 1, 2, \dots; \Re z > 0)$$

$$5.1.6 \quad \beta_n(z) = \int_{-1}^1 t^n e^{-zt} dt \quad (n=0, 1, 2, \dots)$$

In 5.1.1 it is assumed that the path of integration excludes the origin and does not cross the negative real axis.

Analytic continuation of the functions in 5.1.1, 5.1.2, and 5.1.4 for  $n > 0$  yields multi-valued functions with branch points at  $z=0$  and  $z=\infty$ .<sup>3</sup> They are single-valued functions in the  $z$ -plane cut along the negative real axis.<sup>4</sup> The function  $\text{li}(z)$ , the logarithmic integral, has an additional branch point at  $z=1$ .

#### Interrelations

#### 5.1.7

$$E_1(-x \pm i0) = -\text{Ei}(x) \mp i\pi,$$

$$-\text{Ei}(x) = \frac{1}{2}[E_1(-x+i0) + E_1(-x-i0)] \quad (x > 0)$$

<sup>3</sup> Some authors [5.14], [5.16] use the entire function  $\int_0^z (1-e^{-t})dt/t$  as the basic function and denote it by  $\text{Ein}(z)$ . We have  $\text{Ein}(z) = E_1(z) + \ln z + \gamma$ .

<sup>4</sup> Various authors define the integral  $\int_{-\infty}^z (e^t/t)dt$  in the  $z$ -plane cut along the positive real axis and denote it also by  $\text{Ei}(z)$ . For  $z=x > 0$  additional notations such as  $\overline{\text{Ei}}(x)$  (e.g., in [5.10], [5.25]),  $E^*(x)$  (in [5.2]),  $\text{Ei}^*(x)$  (in [5.6]) are then used to designate the principal value of the integral. Correspondingly,  $E_1(x)$  is often denoted by  $-\text{Ei}(-x)$ .

#### Explicit Expressions for $\alpha_n(z)$ and $\beta_n(z)$

$$5.1.8 \quad \alpha_n(z) = n! z^{-n-1} e^{-z} \left( 1 + z + \frac{z^2}{2!} + \dots + \frac{z^n}{n!} \right)$$

#### 5.1.9

$$\beta_n(z) = n! z^{-n-1} \left\{ e^z \left[ 1 - z + \frac{z^2}{2!} - \dots + (-1)^n \frac{z^n}{n!} \right] - e^{-z} \left( 1 + z + \frac{z^2}{2!} + \dots + \frac{z^n}{n!} \right) \right\}$$

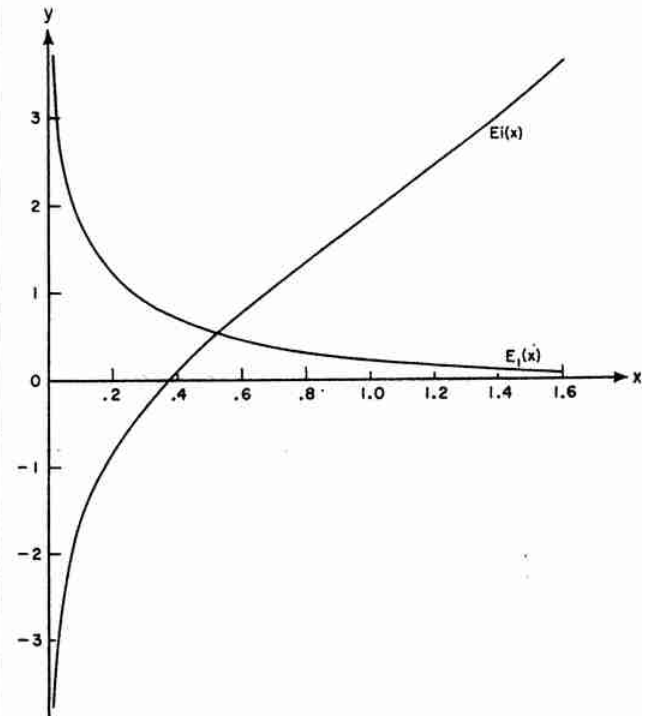

FIGURE 5.1.  $y = \text{Ei}(x)$  and  $y = E_1(x)$ .

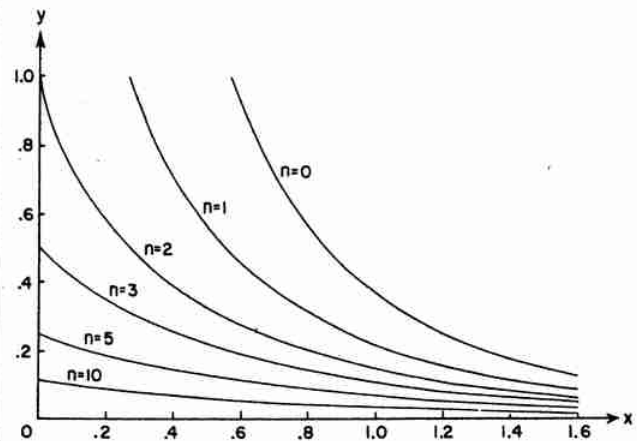

FIGURE 5.2.  $y = E_n(x)$   
 $n=0, 1, 2, 3, 5, 10$

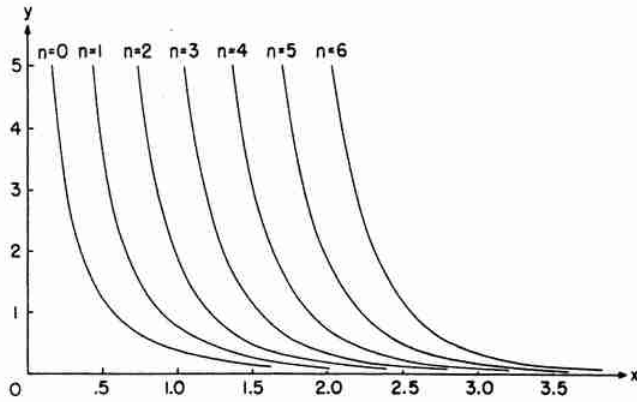

FIGURE 5.3.  $y = \alpha_n(x)$   
 $n = 0(1)6$

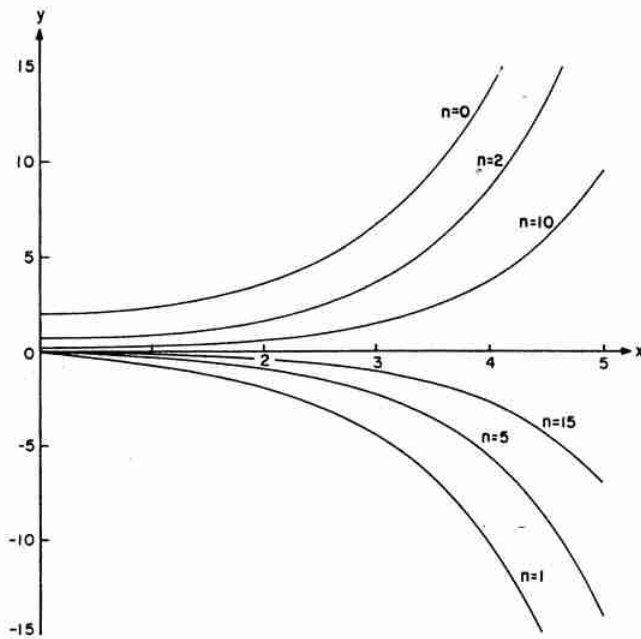

FIGURE 5.4.  $y = \beta_n(x)$   
 $n = 0, 1, 2, 5, 10, 15$

Series Expansions

5.1.10  $Ei(x) = \gamma + \ln x + \sum_{n=1}^{\infty} \frac{x^n}{n n!} \quad (x > 0)$

5.1.11

$E_1(z) = -\gamma - \ln z - \sum_{n=1}^{\infty} \frac{(-1)^n z^n}{n n!} \quad (|\arg z| < \pi)$

5.1.12

$E_n(z) = \frac{(-z)^{n-1}}{(n-1)!} [-\ln z + \psi(n)] - \sum_{\substack{m=0 \\ m \neq n-1}}^{\infty} \frac{(-z)^m}{(m-n+1)m!} \quad (|\arg z| < \pi)$

$\psi(1) = -\gamma, \psi(n) = -\gamma + \sum_{m=1}^{n-1} \frac{1}{m} \quad (n > 1)$

$\gamma = .57721\ 56649 \dots$  is Euler's constant.

Symmetry Relation

5.1.13  $E_n(\bar{z}) = \overline{E_n(z)}$

Recurrence Relations

5.1.14

$E_{n+1}(z) = \frac{1}{n} [e^{-z} - z E_n(z)] \quad (n = 1, 2, 3, \dots)$

5.1.15

$z \alpha_n(z) = e^{-z} + n \alpha_{n-1}(z) \quad (n = 1, 2, 3, \dots)$

5.1.16

$z \beta_n(z) = (-1)^n e^z - e^{-z} + n \beta_{n-1}(z) \quad (n = 1, 2, 3, \dots)$

Inequalities [5.8], [5.4]

5.1.17

$\frac{n-1}{n} E_n(x) < E_{n+1}(x) < E_n(x) \quad (x > 0; n = 1, 2, 3, \dots)$

5.1.18

$E_n^2(x) < E_{n-1}(x) E_{n+1}(x) \quad (x > 0; n = 1, 2, 3, \dots)$

5.1.19

$\frac{1}{x+n} < e^x E_n(x) \leq \frac{1}{x+n-1} \quad (x > 0; n = 1, 2, 3, \dots)$

5.1.20

$\frac{1}{2} \ln \left( 1 + \frac{2}{x} \right) < e^x E_1(x) < \ln \left( 1 + \frac{1}{x} \right) \quad (x > 0)$

5.1.21

$\frac{d}{dx} \left[ \frac{E_n(x)}{E_{n-1}(x)} \right] > 0 \quad (x > 0; n = 1, 2, 3, \dots)$

Continued Fraction

5.1.22

$E_n(z) = e^{-z} \left( \frac{1}{z+1} + \frac{n-1}{z+1} \frac{1}{z+1} + \frac{n-1}{z+1} \frac{n-2}{z+1} \dots \right) \quad (|\arg z| < \pi)$

Special Values

5.1.23

$E_n(0) = \frac{1}{n-1} \quad (n > 1)$

5.1.24

$E_0(z) = \frac{e^{-z}}{z}$

5.1.25

$\alpha_0(z) = \frac{e^{-z}}{z}, \beta_0(z) = \frac{2}{z} \sinh z$

## Derivatives

$$5.1.26 \quad \frac{dE_n(z)}{dz} = -E_{n-1}(z) \quad (n=1, 2, 3, \dots)$$

5.1.27

$$\frac{d^n}{dz^n} [e^z E_1(z)] = \frac{d^{n-1}}{dz^{n-1}} [e^z E_1(z)] + \frac{(-1)^n (n-1)!}{z^n} \quad (n=1, 2, 3, \dots)$$

## Definite and Indefinite Integrals

(For more extensive tables of integrals see [5.3], [5.6], [5.11], [5.12], [5.13]. For integrals involving  $E_n(x)$  see [5.9].)

$$5.1.28 \quad \int_0^\infty \frac{e^{-at}}{b+t} dt = e^{ab} E_1(ab)$$

5.1.29

$$\int_0^\infty \frac{e^{iat}}{b+t} dt = e^{-iab} E_1(-iab) \quad (a > 0, b > 0)$$

5.1.30

$$\int_0^\infty \frac{t-ib}{t^2+b^2} e^{iat} dt = e^{ab} E_1(ab) \quad (a > 0, b > 0)$$

5.1.31

$$\int_0^\infty \frac{t+ib}{t^2+b^2} e^{iat} dt = e^{-ab} (-\text{Ei}(ab) + i\pi) \quad (a > 0, b > 0)$$

$$5.1.32 \quad \int_0^\infty \frac{e^{-at} - e^{-bt}}{t} dt = \ln \frac{b}{a}$$

$$5.1.33 \quad \int_0^\infty E_1^2(t) dt = 2 \ln 2$$

5.1.34

$$\int_0^\infty e^{-at} E_n(t) dt = \frac{(-1)^{n-1}}{a^n} \left[ \ln(1+a) + \sum_{k=1}^{n-1} \frac{(-1)^k a^k}{k} \right] \quad (a > -1)$$

5.1.35

$$\int_0^1 \frac{e^{at} \sin bt}{t} dt = \pi - \arctan \frac{b}{a} + \mathcal{I} E_1(-a+ib) \quad (a > 0, b > 0)$$

5.1.36

$$\int_0^1 \frac{e^{-at} \sin bt}{t} dt = \arctan \frac{b}{a} + \mathcal{I} E_1(a+ib) \quad (a > 0, b \text{ real})$$

5.1.37

$$\int_0^1 \frac{e^{at}(1-\cos bt)}{t} dt = \frac{1}{2} \ln \left( 1 + \frac{b^2}{a^2} \right) + \text{Ei}(a) + \mathcal{R} E_1(-a+ib) \quad (a > 0, b \text{ real})$$

5.1.38

$$\int_0^1 \frac{e^{-at}(1-\cos bt)}{t} dt = \frac{1}{2} \ln \left( 1 + \frac{b^2}{a^2} \right) - E_1(a) + \mathcal{R} E_1(a+ib) \quad (a > 0, b \text{ real})$$

$$5.1.39 \quad \int_0^z \frac{1-e^{-t}}{t} dt = E_1(z) + \ln z + \gamma$$

$$5.1.40 \quad \int_0^x \frac{e^t-1}{t} dt = \text{Ei}(x) - \ln x - \gamma \quad (x > 0)$$

5.1.41

$$\int \frac{e^{ix}}{a^2+x^2} dx = \frac{i}{2a} [e^{-a} E_1(-a-ix) - e^a E_1(a-ix)] + \text{const.}$$

5.1.42

$$\int \frac{x e^{ix}}{a^2+x^2} dx = -\frac{1}{2} [e^{-a} E_1(-a-ix) + e^a E_1(a-ix)] + \text{const.}$$

5.1.43

$$\int \frac{e^x}{a^2+x^2} dx = -\frac{1}{a} \mathcal{I} (e^{ia} E_1(-x+ia)) + \text{const.} \quad (a > 0)$$

5.1.44

$$\int \frac{x e^x}{a^2+x^2} dx = -\mathcal{R} (e^{ia} E_1(-x+ia)) + \text{const.} \quad (a > 0)$$

## Relation to Incomplete Gamma Function (see 6.5)

$$5.1.45 \quad E_n(z) = z^{n-1} \Gamma(1-n, z)$$

$$5.1.46 \quad \alpha_n(z) = z^{-n-1} \Gamma(n+1, z)$$

$$5.1.47 \quad \beta_n(z) = z^{-n-1} [\Gamma(n+1, -z) - \Gamma(n+1, z)]$$

## Relation to Spherical Bessel Functions (see 10.2)

$$5.1.48 \quad \alpha_0(z) = \sqrt{\frac{2}{\pi z}} K_1(z), \quad \beta_0(z) = \sqrt{\frac{2\pi}{z}} I_{3/2}(z)$$

$$5.1.49 \quad \alpha_1(z) = \sqrt{\frac{2}{\pi z}} K_{3/2}(z), \quad \beta_1(z) = -\sqrt{\frac{2\pi}{z}} I_{3/2}(z)$$

Number-Theoretic Significance of  $\text{li}(x)$

(Assuming Riemann's hypothesis that all non-real zeros of  $\zeta(z)$  have a real part of  $\frac{1}{2}$ )

5.1.50  $\text{li}(x) - \pi(x) = O(\sqrt{x} \ln x)$  ( $x \rightarrow \infty$ )

$\pi(x)$  is the number of primes less than or equal to  $x$ .

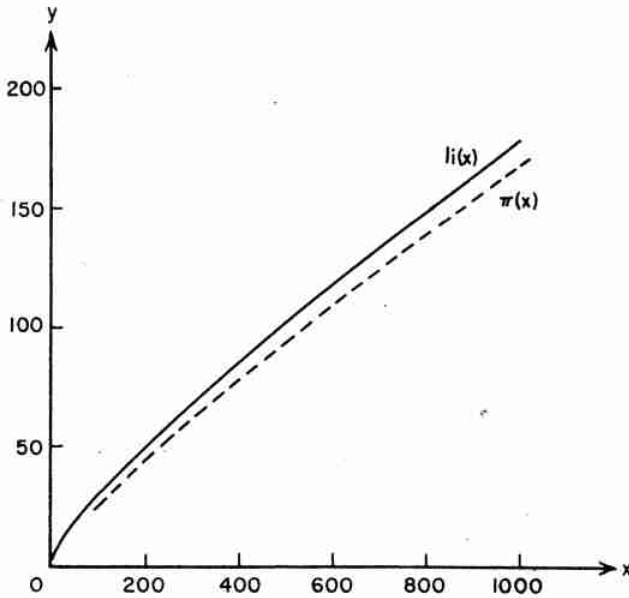

FIGURE 5.5.  $y = \text{li}(x)$  and  $y = \pi(x)$

Asymptotic Expansion

5.1.51

$$E_n(z) \sim \frac{e^{-z}}{z} \left\{ 1 - \frac{n}{z} + \frac{n(n+1)}{z^2} - \frac{n(n+1)(n+2)}{z^3} + \dots \right\}$$

( $|\arg z| < \frac{3}{2}\pi$ )

Representation of  $E_n(x)$  for Large  $n$

5.1.52

$$E_n(x) = \frac{e^{-x}}{x+n} \left\{ 1 + \frac{n}{(x+n)^2} + \frac{n(n-2x)}{(x+n)^4} + \frac{n(6x^2 - 8nx + n^2)}{(x+n)^6} + R(n, x) \right\}$$

$$-.36n^{-4} \leq R(n, x) \leq \left( 1 + \frac{1}{x+n-1} \right) n^{-4} \quad (x > 0)$$

Polynomial and Rational Approximations<sup>5</sup>

5.1.53

$$0 \leq x \leq 1$$

$$E_1(x) + \ln x = a_0 + a_1x + a_2x^2 + a_3x^3 + a_4x^4 + a_5x^5 + \epsilon(x)$$

$$|\epsilon(x)| < 2 \times 10^{-7}$$

<sup>5</sup> The approximation 5.1.53 is from E. E. Allen, Note 169, MTAC 8, 240 (1954); approximations 5.1.54 and 5.1.56 are from C. Hastings, Jr., Approximations for digital computers, Princeton Univ. Press, Princeton, N.J., 1955; approximation 5.1.55 is from C. Hastings, Jr., Note 143, MTAC 7, 68 (1953) (with permission).

$$\begin{aligned} a_0 &= -.57721\ 566 & a_3 &= .05519\ 968 \\ a_1 &= .99999\ 193 & a_4 &= -.00976\ 004 \\ a_2 &= -.24991\ 055 & a_5 &= .00107\ 857 \end{aligned}$$

5.1.54

$$1 \leq x < \infty$$

$$xe^xE_1(x) = \frac{x^2 + a_1x + a_2}{x^2 + b_1x + b_2} + \epsilon(x)$$

$$|\epsilon(x)| < 5 \times 10^{-5}$$

$$\begin{aligned} a_1 &= 2.334733 & b_1 &= 3.330657 \\ a_2 &= .250621 & b_2 &= 1.681534 \end{aligned}$$

5.1.55

$$10 \leq x < \infty$$

$$xe^xE_1(x) = \frac{x^2 + a_1x + a_2}{x^2 + b_1x + b_2} + \epsilon(x)$$

$$|\epsilon(x)| < 10^{-7}$$

$$\begin{aligned} a_1 &= 4.03640 & b_1 &= 5.03637 \\ a_2 &= 1.15198 & b_2 &= 4.19160 \end{aligned}$$

5.1.56

$$1 \leq x < \infty$$

$$xe^xE_1(x) = \frac{x^4 + a_1x^3 + a_2x^2 + a_3x + a_4}{x^4 + b_1x^3 + b_2x^2 + b_3x + b_4} + \epsilon(x)$$

$$|\epsilon(x)| < 2 \times 10^{-8}$$

$$\begin{aligned} a_1 &= 8.57332\ 87401 & b_1 &= 9.57332\ 23454 \\ a_2 &= 18.05901\ 69730 & b_2 &= 25.63295\ 61486 \\ a_3 &= 8.63476\ 08925 & b_3 &= 21.09965\ 30827 \\ a_4 &= .26777\ 37343 & b_4 &= 3.95849\ 69228 \end{aligned}$$

5.2. Sine and Cosine Integrals

Definitions

5.2.1  $\text{Si}(z) = \int_0^z \frac{\sin t}{t} dt$

5.2.2<sup>6</sup>  $\text{Ci}(z) = \gamma + \ln z + \int_0^z \frac{\cos t - 1}{t} dt$  ( $|\arg z| < \pi$ )

5.2.3<sup>7</sup>  $\text{Shi}(z) = \int_0^z \frac{\sinh t}{t} dt$

5.2.4<sup>7</sup>  $\text{Chi}(z) = \gamma + \ln z + \int_0^z \frac{\cosh t - 1}{t} dt$  ( $|\arg z| < \pi$ )

<sup>6</sup> Some authors [5.14], [5.16] use the entire function  $\int_0^z (1 - \cos t) dt/t$  as the basic function and denote it by  $\text{Cin}(z)$ . We have

$$\text{Cin}(z) = -\text{Ci}(z) + \ln z + \gamma.$$

<sup>7</sup> The notations  $\text{Sih}(z) = \int_0^z \sinh t dt/t$ ,  $\text{Cinh}(z) = \int_0^z (\cosh t - 1) dt/t$  have also been proposed [5.14.]

$$5.2.5 \quad \text{si}(z) = \text{Si}(z) - \frac{\pi}{2}$$

#### Auxiliary Functions

$$5.2.6 \quad f(z) = \text{Ci}(z) \sin z - \text{si}(z) \cos z$$

$$5.2.7 \quad g(z) = -\text{Ci}(z) \cos z - \text{si}(z) \sin z$$

#### Sine and Cosine Integrals in Terms of Auxiliary Functions

$$5.2.8 \quad \text{Si}(z) = \frac{\pi}{2} - f(z) \cos z - g(z) \sin z$$

$$5.2.9 \quad \text{Ci}(z) = f(z) \sin z - g(z) \cos z$$

#### Integral Representations

$$5.2.10 \quad \text{si}(z) = -\int_0^{\frac{\pi}{2}} e^{-z \cos t} \cos(z \sin t) dt$$

$$5.2.11 \quad \text{Ci}(z) + E_1(z) = \int_0^{\frac{\pi}{2}} e^{-z \cos t} \sin(z \sin t) dt$$

$$5.2.12 \quad f(z) = \int_0^{\infty} \frac{\sin t}{t+z} dt = \int_0^{\infty} \frac{e^{-zt}}{t^2+1} dt \quad (\Re z > 0)$$

$$5.2.13 \quad g(z) = \int_0^{\infty} \frac{\cos t}{t+z} dt = \int_0^{\infty} \frac{te^{-zt}}{t^2+1} dt \quad (\Re z > 0)$$

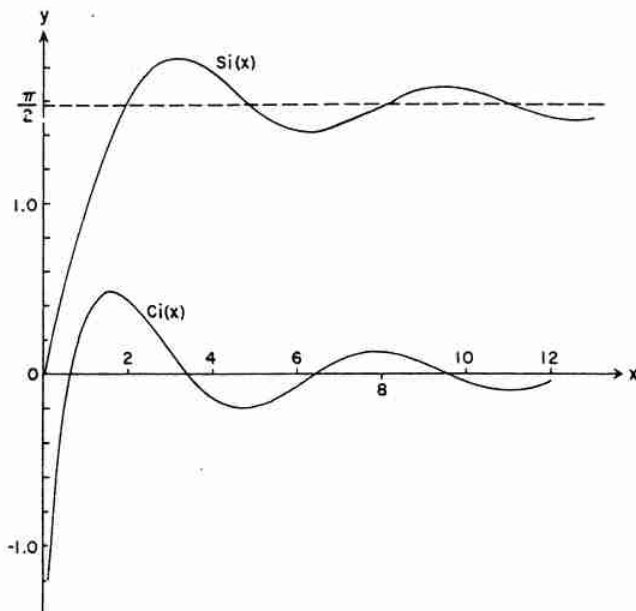

FIGURE 5.6.  $y = \text{Si}(x)$  and  $y = \text{Ci}(x)$

#### Series Expansions

$$5.2.14 \quad \text{Si}(z) = \sum_{n=0}^{\infty} \frac{(-1)^n z^{2n+1}}{(2n+1)(2n+1)!}$$

$$5.2.15 \quad \text{Si}(z) = \pi \sum_{n=0}^{\infty} J_{n+1}^2\left(\frac{z}{2}\right)$$

$$5.2.16 \quad \text{Ci}(z) = \gamma + \ln z + \sum_{n=1}^{\infty} \frac{(-1)^n z^{2n}}{2n(2n)!}$$

$$5.2.17 \quad \text{Shi}(z) = \sum_{n=0}^{\infty} \frac{z^{2n+1}}{(2n+1)(2n+1)!}$$

$$5.2.18 \quad \text{Chi}(z) = \gamma + \ln z + \sum_{n=1}^{\infty} \frac{z^{2n}}{2n(2n)!}$$

#### Symmetry Relations

$$5.2.19 \quad \text{Si}(-z) = -\text{Si}(z), \quad \text{Si}(\bar{z}) = \overline{\text{Si}(z)}$$

#### 5.2.20

$$\text{Ci}(-z) = \text{Ci}(z) - i\pi \quad (0 < \arg z < \pi)$$

$$\text{Ci}(\bar{z}) = \overline{\text{Ci}(z)}$$

#### Relation to Exponential Integral

#### 5.2.21

$$\text{Si}(z) = \frac{1}{2i} [E_1(iz) - E_1(-iz)] + \frac{\pi}{2} \quad (|\arg z| < \frac{\pi}{2})$$

$$5.2.22 \quad \text{Si}(ix) = \frac{i}{2} [E_1(x) + E_1(x)] \quad (x > 0)$$

#### 5.2.23

$$\text{Ci}(z) = -\frac{1}{2} [E_1(iz) + E_1(-iz)] \quad (|\arg z| < \frac{\pi}{2})$$

$$5.2.24 \quad \text{Ci}(ix) = \frac{1}{2} [E_1(x) - E_1(x)] + i\frac{\pi}{2} \quad (x > 0)$$

#### Value at Infinity

$$5.2.25 \quad \lim_{x \rightarrow \infty} \text{Si}(x) = \frac{\pi}{2}$$

#### Integrals

(For more extensive tables of integrals see [5.3], [5.6], [5.11], [5.12], [5.13].)

$$5.2.26 \quad \int_z^{\infty} \frac{\sin t}{t} dt = -\text{si}(z) \quad (|\arg z| < \pi)$$

$$5.2.27 \quad \int_z^{\infty} \frac{\cos t}{t} dt = -\text{Ci}(z) \quad (|\arg z| < \pi)$$

$$5.2.28 \quad \int_0^{\infty} e^{-at} \text{Ci}(t) dt = -\frac{1}{2a} \ln(1+a^2) \quad (\Re a > 0)^*$$

$$5.2.29 \quad \int_0^{\infty} e^{-at} \text{si}(t) dt = -\frac{1}{a} \arctan a \quad (\Re a > 0)$$

$$5.2.30 \quad \int_0^{\infty} \cos t \text{Ci}(t) dt = \int_0^{\infty} \sin t \text{si}(t) dt = -\frac{\pi}{4}$$

\*See page 11.

5.2.31  $\int_0^\infty \text{Ci}^2(t) dt = \int_0^\infty \text{si}^2(t) dt = \frac{\pi}{2}$

5.2.32\*  $\int_0^\infty \text{Ci}(t) \text{si}(t) dt = \ln 2$

5.2.33  $\int_0^1 \frac{(1-e^{-at}) \cos bt}{t} dt = \frac{1}{2} \ln \left(1 + \frac{a^2}{b^2}\right) + \text{Ci}(b)$   
 $+ \mathcal{R}E_1(a+ib)$  ( $a$  real,  $b > 0$ )

Asymptotic Expansions

5.2.34  $f(z) \sim \frac{1}{z} \left(1 - \frac{2!}{z^2} + \frac{4!}{z^4} - \frac{6!}{z^6} + \dots\right)$  ( $|\arg z| < \pi$ )

5.2.35  $g(z) \sim \frac{1}{z^2} \left(1 - \frac{3!}{z^2} + \frac{5!}{z^4} - \frac{7!}{z^6} + \dots\right)$  ( $|\arg z| < \pi$ )

Rational Approximations<sup>8</sup>

5.2.36  $1 \leq x < \infty$   
 $f(x) = \frac{1}{x} \left(\frac{x^4 + a_1x^2 + a_2}{x^4 + b_1x^2 + b_2}\right) + \epsilon(x)$   
 $|\epsilon(x)| < 2 \times 10^{-4}$   
 $a_1 = 7.241163 \quad b_1 = 9.068580$   
 $a_2 = 2.463936 \quad b_2 = 7.157433$

5.2.37  $1 \leq x < \infty$   
 $g(x) = \frac{1}{x^2} \left(\frac{x^4 + a_1x^2 + a_2}{x^4 + b_1x^2 + b_2}\right) + \epsilon(x)$   
 $|\epsilon(x)| < 10^{-4}$   
 $a_1 = 7.547478 \quad b_1 = 12.723684$  \*  
 $a_2 = 1.564072 \quad b_2 = 15.723606$  \*

5.2.38  $1 \leq x < \infty$   
 $f(x) = \frac{1}{x} \left(\frac{x^8 + a_1x^6 + a_2x^4 + a_3x^2 + a_4}{x^8 + b_1x^6 + b_2x^4 + b_3x^2 + b_4}\right) + \epsilon(x)$   
 $|\epsilon(x)| < 5 \times 10^{-7}$   
 $a_1 = 38.027264 \quad b_1 = 40.021433$   
 $a_2 = 265.187033 \quad b_2 = 322.624911$   
 $a_3 = 335.677320 \quad b_3 = 570.236280$   
 $a_4 = 38.102495 \quad b_4 = 157.105423$

5.2.39  $1 \leq x < \infty$   
 $g(x) = \frac{1}{x^2} \left(\frac{x^8 + a_1x^6 + a_2x^4 + a_3x^2 + a_4}{x^8 + b_1x^6 + b_2x^4 + b_3x^2 + b_4}\right) + \epsilon(x)$   
 $|\epsilon(x)| < 3 \times 10^{-7}$   
 $a_1 = 42.242855 \quad b_1 = 48.196927$   
 $a_2 = 302.757865 \quad b_2 = 482.485984$   
 $a_3 = 352.018498 \quad b_3 = 1114.978885$   
 $a_4 = 21.821899 \quad b_4 = 449.690326$

Numerical Methods

5.3. Use and Extension of the Tables

**Example 1.** Compute Ci (.25) to 5D. From Tables 5.1 and 4.2 we have

$$\frac{\text{Ci}(.25) - \ln(.25) - \gamma}{(.25)^2} = -.249350,$$

$$\text{Ci}(.25) = (.25)^2(-.249350) + (-1.38629) + .577216 = -.82466.$$

**Example 2.** Compute Ei (8) to 5S.

From Table 5.1 we have  $xe^{-x}\text{Ei}(x) = 1.18185$  for  $x=8$ . From Table 4.4,  $e^8 = 2.98096 \times 10^3$ . Thus  $\text{Ei}(8) = 440.38$ .

\*See page II.

<sup>8</sup> From C. Hastings, Jr., Approximations for digital computers, Princeton Univ. Press, Princeton, N.J., 1955 (with permission).

**Example 3.** Compute Si (20) to 5D.

Since  $1/20 = .05$  from Table 5.2 we find  $f(20) = .049757$ ,  $g(20) = .002464$ . From Table 4.8,  $\sin 20 = .912945$ ,  $\cos 20 = .408082$ . Using 5.2.8

$$\text{Si}(20) = \frac{\pi}{2} f(20) \cos 20 - g(20) \sin 20 = 1.570796 - .022555 = 1.54824.$$

**Example 4.** Compute  $E_n(x)$ ,  $n=1(1)N$ , to 5S for  $x=1.275$ ,  $N=10$ .

If  $x$  is less than about five, the recurrence relation 5.1.14 can be used in increasing order of  $n$  without serious loss of accuracy.

By quadratic interpolation in Table 5.1 we get  $E_1(1.275) = .1408099$ , and from Table 4.4,  $e^{-1.275} = .2794310$ . The recurrence formula 5.1.14 then yields



| $n$ | $E_n(1.275)$ | $E_n(1.275)$ |
|-----|--------------|--------------|
| 1   | .1408099     | 6 .0430168   |
| 2   | .0998984     | 7 .0374307   |
| 3   | .0760303     | 8 .0331009   |
| 4   | .0608307     | 9 .0296534   |
| 5   | .0504679     | 10 .0268469  |

Interpolating directly in Table 5.4 for  $n=10$  we get  $E_{10}(1.275)=.0268470$  as a check.

**Example 5.** Compute  $E_n(x)$ ,  $n=1(1)N$ , to 5S for  $x=10$ ,  $N=10$ .

If, as in this example,  $x$  is appreciably larger than five and  $N \leq x$ , then the recurrence relation 5.1.14 may be safely used in decreasing order of  $n$  ([5.5]). From Table 5.5 for  $x^{-1}=.1$  we get  $(x+10)e^x E_{10}(x)=1.02436$  so that  $E_{10}(10)=2.32529 \times 10^{-6}$ . Using this as the initial value we obtain column (2).

| $n$ | $10^6 E_n(10)$<br>(1) | $10^6 E_n(10)$<br>(2) |
|-----|-----------------------|-----------------------|
| 1   | .41570                | .41570                |
| 2   | .38300                | .38302                |
| 3   | .35500                | .35488                |
| 4   | .33000                | .33041                |
| 5   | .31000                | .30898                |
| 6   | .28800                | .29005                |
| 7   | .27667                | .27325                |
| 8   | .25333                | .25822                |
| 9   | .25084                | .24472                |
| 10  | .22573                | .23253                |

From Table 5.2 we get  $xe^x E_1(x)=.915633$  so that  $E_1(10)=4.15697 \times 10^{-6}$  as a check. Forward recurrence starting with  $E_1(10)=4.1570 \times 10^{-6}$  yields the values in column (1). The underlined figures are in error.

**Example 6.** Compute  $E_n(x)$ ,  $n=1(1)N$ , to 5S for  $x=12.3$ ,  $N=20$ .

If  $N$  is appreciably larger than  $x$ , and  $x$  appreciably larger than five, then the recurrence relation 5.1.14 should be used in the backward direction to generate  $E_n(x)$  for  $n < n_0$ , and in the forward direction to generate  $E_n(x)$  for  $n > n_0$ , where  $n_0 = (x)$ .

From 5.1.52, with  $n_0=12$ ,  $x=12.3$ , we have

$$E_{n_0}(x) = \frac{e^{-12.3}}{24.3} (1 + .02032 - .00043 - .00001) = 1.91038 \times 10^{-7}.$$

Using the recurrence relation 5.1.14, as indicated, we get

| $n$ | $10^6 E_n(12.3)$ | $10^6 E_n(12.3)$ | $n$ |
|-----|------------------|------------------|-----|
| 12  | .191038          | .191038          | 12  |
| 11  | .199213          | .183498          | 13  |
| 10  | .208098          | .176516          | 14  |
| 9   | .217793          | .170042          | 15  |
| 8   | .228406          | .164015          | 16  |
| 7   | .240073          | .158397          | 17  |
| 6   | .252951          | .153144          | 18  |
| 5   | .267234          | .148226          | 19  |
| 4   | .283155          | .143608          | 20  |
| 3   | .300998          |                  |     |
| 2   | .321117          |                  |     |
| 1   | .343953          |                  |     |

From Tables 5.2 and 5.5 we find  $E_1(12.3)=.343953 \times 10^{-6}$ ,  $E_{20}(12.3)=.143609 \times 10^{-6}$  as a check.

**Example 7.** Compute  $\alpha_n(2)$  to 6S for  $n=1(1)5$ .

The recurrence formula 5.1.15 can be used for all  $x > 0$  in increasing order of  $n$  without loss of accuracy. From 5.1.25 we have  $\alpha_0(2) = \frac{1}{2} e^{-2} = .0676676$ , so we get

| $n$ | $\alpha_n(2)$ |
|-----|---------------|
| 0   | .0676676      |
| 1   | .101501       |
| 2   | .169169       |
| 3   | .321421       |
| 4   | .710510       |
| 5   | 1.84394       |

Independent calculation with 5.1.8 yields the same result for  $\alpha_5(2)$ .

The functions  $\alpha_0(x)$  and  $\alpha_1(x)$  can be obtained from Table 10.8 using 5.1.48, 5.1.49.

**Example 8.** Compute  $\beta_n(x)$ ,  $n=0(1)N$  to 6S for  $x=1$ ,  $N=5$ .

Use the recurrence relation 5.1.16 in increasing order of  $n$  if

$$x > .368N + .184 \ln N + .821$$

and in decreasing order of  $n$  otherwise [5.5].

From 5.1.9 with  $n=5$  we get  $\beta_5(1) = -.324297$  correctly rounded to 6D. Using the recurrence formula 5.1.16 in decreasing order of  $n$  and carrying 9D we get the values in column (2).

| $n$ | $\beta_n(1)$<br>(1) | $\beta_n(1)$<br>(2) |
|-----|---------------------|---------------------|
| 0   | 2.35040 2           | 2.35040 2389        |
| 1   | -.73575 9269        | -.73575 8880        |
| 2   | .87888 3849         | .87888 4629         |
| 3   | -.44950 9722        | -.44950 7383        |
| 4   | .55236 3499         | .55237 2854         |
| 5   | -.32434 3774        | -.32429 7           |

Using forward recurrence instead, starting with

$\beta_0(1)=2 \sinh 1=2.350402$  and again carrying 9D, we obtain column (1). The underlined figures are in error. The above shows that three significant figures are lost in forward recurrence, whereas about three significant figures are gained in backward recurrence!

An alternative procedure is to start with an arbitrary value for  $n$  sufficiently large (see also [5.1]). To illustrate, starting with the value zero at  $n=11$  we get

|     |              |     |              |
|-----|--------------|-----|--------------|
| $n$ | $\beta_n(1)$ | $n$ | $\beta_n(1)$ |
| 11  | 0.           | 5   | -.324297     |
| 10  | .280560      | 4   | .552373      |
| 9   | -.206984     | 3   | -.449507     |
| 8   | .319908      | 2   | .878885      |
| 7   | -.253812     | 1   | -.735759     |
| 6   | .404621      | 0   | 2.350402     |

The functions  $\beta_0(x)$  and  $\beta_1(x)$  can be obtained from Table 10.8 using 5.1.48, 5.1.49.

**Example 9.** Compute  $E_1(z)$  for  $z=3.2578+6.8943i$ .

From Table 5.6 we have for  $z_0=x_0+iy_0=3+7i$   
 $z_0 e^{z_0} E_1(z_0) = .934958 + .095598i,$   
 $e^{z_0} E_1(z_0) = .059898 - .107895i.$

From Taylor's formula with  $f(z) = e^z E_1(z)$  we have

$$f(z) = f(z_0 + \Delta z) = f(z_0) + \frac{f'(z_0)}{1!} \Delta z + \frac{f''(z_0)}{2!} (\Delta z)^2 + \dots$$

with  $\Delta z = z - z_0 = .2578 - .1057i$ . Thus with 5.1.27 we get

| $k$ | $f^{(k)}(z_0)/k!$   | $(\Delta z)^k f^{(k)}(z_0)/k!$ |
|-----|---------------------|--------------------------------|
| 0   | .059898 - .107895i  | .059898 - .107895i             |
| 1   | .008174 + .012795i  | .003460 + .002435i             |
| 2   | -.001859 + .000155i | -.000094 + .000110i            |
| 3   | .000088 - .000212i  | -.000003 - .000004i            |

$$f(z) = .063261 - .105354i$$

$$e^{-z} = .031510 - .022075i$$

$$E_1(z) = -.000332 - .004716i$$

Repeating the calculation with  $z_0 = 3 + 6i$  and  $\Delta z = .2578 + .8943i$  we get the same result.

An alternative procedure is to perform bivariate interpolation in the real and imaginary parts of  $ze^z E_1(z)$ .

**Example 10.** Compute  $E_1(z)$  for  $z = -4.2 + 12.7i$ .

Using the formula at the bottom of Table 5.6

$$e^z E_1(z) \approx \frac{.711093}{-3.784225 + 12.7i} + \frac{.278518}{-1.90572 + 12.7i} + \frac{.010389}{2.0900 + 12.7i}$$

$$= -.0184106 - .0736698i$$

$$E_1(z) \approx -1.87133 - 4.70540i.$$

References

Texts

[5.1] F. J. Corbató, On the computation of auxiliary functions for two-center integrals by means of a high-speed computer, *J. Chem. Phys.* **24**, 452-453 (1956).

[5.2] A. Erdélyi et al., Higher transcendental functions, vol. 2 (McGraw-Hill Book Co., Inc., New York, N.Y., 1953).

[5.3] A. Erdélyi et al., Tables of integral transforms, vols. 1, 2 (McGraw-Hill Book Co., Inc., New York, N.Y., 1954).

[5.4] W. Gautschi, Some elementary inequalities relating to the gamma and incomplete gamma function, *J. Math. Phys.* **38**, 77-81 (1959).

[5.5] W. Gautschi, Recursive computation of certain integrals, *J. Assoc. Comput. Mach.* **8**, 21-40 (1961).

[5.6] W. Gröbner and N. Hofreiter, *Integraltafel* (Springer-Verlag, Wien and Innsbruck, Austria, 1949-50).

[5.7] C. Hastings, Jr., *Approximations for digital computers* (Princeton Univ. Press, Princeton, N.J., 1955).

[5.8] E. Hopf, *Mathematical problems of radiative equilibrium*, Cambridge Tracts in Mathematics and Mathematical Physics, No. 31 (Cambridge Univ. Press, Cambridge, England, 1934).

[5.9] V. Kourganoff, *Basic methods in transfer problems* (Oxford Univ. Press, London, England, 1952).

[5.10] F. Lösch and F. Schoblik, *Die Fakultät und verwandte Funktionen* (B. G. Teubner, Leipzig, Germany, 1951).

[5.11] N. Nielsen, *Theorie des Integrallogarithmus* (B. G. Teubner, Leipzig, Germany, 1906).

- [5.12] F. Oberhettinger, Tabellen zur Fourier Transformation (Springer-Verlag, Berlin, Göttingen, Heidelberg, Germany, 1957).
- [5.13] I. M. Ryshik and I. S. Gradstein, Tables of series, products and integrals (VEB Deutscher Verlag der Wissenschaften, Berlin, Germany, 1957).
- [5.14] S. A. Schelkunoff, Proposed symbols for the modified cosine and exponential integral, *Quart. Appl. Math.* **2**, 90 (1944).
- [5.15] J. Todd, Evaluation of the exponential integral for large complex arguments, *J. Research NBS* **52**, 313-317 (1954) RP 2508.
- [5.16] F. G. Tricomi, Funzioni ipergeometriche confluenti (Edizioni Cremonese, Rome, Italy, 1954).
- Tables**
- [5.17] British Association for the Advancement of Science, *Mathematical Tables*, vol. I. Circular and hyperbolic functions, exponential, sine and cosine integrals, etc., 3d ed. (Cambridge Univ. Press, Cambridge, England, 1951).  $Ei(x) - \ln x$ ,  $-E_1(x) - \ln x$ ,  $Ci(x) - \ln x$ ,  $Si(x)$ ,  $x=0(.1)5$ , 11D;  $Ei(x)$ ,  $x=5(.1)15$ , 10-11S;  $E_1(x)$ ,  $x=5(.1)15$ , 13-14D;  $Si(x)$ ,  $Ci(x)$ ,  $x=5(.1)20(.2)40$ , 10D.
- [5.18] L. Fox, *Tables of Weber parabolic cylinder functions and other functions for large arguments*, *Mathematical Tables*, vol. 4, National Physical Laboratory (Her Majesty's Stationery Office, London, England, 1960).  $e^{-x}Ei(x)$ ,  $e^xE_1(x)$ ,  $x^{-1}=0(.001).1$ , 10D;  $f(x)$ ,  $g(x)$ ,  $x^{-1}=0(.001).1$ , 10D.
- [5.19] J. W. L. Glaisher, Tables of the numerical values of the sine-integral, cosine-integral and exponential integral, *Philos. Trans. Roy. Soc. London* **160**, 367-388 (1870).  $Si(x)$ ,  $Ci(x)$ ,  $Ei(x)$ ,  $-E_1(x)$ ,  $x=0(.01)1$ , 18D,  $x=1(.1)5(1)15$ , 11D.
- [5.20] B. S. Gourary and M. E. Lynam, Tables of the auxiliary molecular integrals  $A_n(x)$  and the auxiliary functions  $C_n(x)$ , The Johns Hopkins Univ. Applied Physics Laboratory, CM Report 905, Baltimore, Md. (1957).  $\alpha_n(x)$ ,  $n!e_n(x)$ ,  $x=.05(.05)15$ ,  $n=0(1)18$ , 9S.
- [5.21] F. E. Harris, Tables of the exponential integral  $Ei(x)$ , *Math. Tables Aids Comp.* **11**, 9-16 (1957).  $E_1(x)$ ,  $e^xE_1(x)$ ,  $Ei(x)$ ,  $e^{-x}Ei(x)$ ,  $x=1(1)4(.4)8(1)50$ , 18-19S.
- [5.22] Harvard University, The Annals of the Computation Laboratory, vols. 18, 19; Tables of the generalized sine- and cosine-integral functions, parts I, II (Harvard Univ. Press, Cambridge, Mass., 1949).  $S(a, x) = \int_0^x \frac{\sin u}{u} dx$ ,  $C(a, x) = \int_0^x \frac{1 - \cos u}{u} dx$ , 6D;  $Ss(a, x) = \int_0^x \frac{\sin u}{u} \sin x dx$ ,  $Sc(a, x) = \int_0^x \frac{\sin u}{u} \cos x dx$ , 6D;  $Cs(a, x) = \int_0^x \frac{\cos u}{u} \sin x dx$ ,  $Cc(a, x) = \int_0^x \frac{\cos u}{u} (1 - \cos x) dx$ , 6D;  $u = \sqrt{x^2 + a^2}$ ,  $0 \leq a < 25$ ,  $0 \leq x \leq 25$ .
- [5.23] Harvard University, The Annals of the Computation Laboratory, vol. 21; Tables of the generalized exponential-integral functions (Harvard Univ. Press, Cambridge, Mass., 1949).  $E(a, x) = \int_0^x \frac{1 - e^{-u}}{u} dx$ ,  $Es(a, x) = \int_0^x \frac{e^{-u} \sin u}{u} dx$ ,  $Ec(a, x) = \int_0^x \frac{1 - e^{-u} \cos u}{u} dx$ , 6D;  $u = \sqrt{x^2 + a^2}$ ,  $0 \leq a < 10$ ,  $0 \leq x < 10$ .
- [5.24] A. V. Hershey, Computing programs for the complex exponential integral, U.S. Naval Proving Ground, Dahlgren, Va., NPG Report No. 1646 (1959).  $-E_1(-z)$ ,  $z = x + iy$ ,  $x = -20(1)20$ ,  $y = 0(1)20$ , 13S.
- [5.25] E. Jahnke and F. Emde, *Tables of functions*, 4th ed. (Dover Publications, Inc., New York, N.Y., 1945).  $-E_1(x)$ ,  $Ei(x)$ ,  $x=0(.01)1(.1)5(1)15$ , 4-6S;  $Si(x)$ ,  $Ci(x)$ ,  $x=0(.01)1(.1)5(1)15(5)100(10)200(100)10^{(10)}$ , generally 4-5S; maxima and minima of  $Ci(x)$  and  $si(x)$ ,  $0 < x < 16$ , 5S.
- [5.26] K. A. Karpov and S. N. Razumovskii, *Tablitsy integral' nogo logarifma* (Izdat. Akad. Nauk SSSR., Moscow, U.S.S.R., 1956).  $li(x)$ ,  $x=0(.0001)2.5(.001)20(.01)200(.1)500(1)10000(10)25000$ , 7S;  $li(x) - \ln |1-x|$ ,  $x=.95(.0001)1.05$ , 6D.
- [5.27] M. Kotani, A. Amemiya, E. Ishiguro, T. Kimura, *Table of molecular integrals* (Maruzen Co., Ltd., Tokyo, Japan, 1955).  $\alpha_n(x)$ ,  $x=.25(.25)9(.5)19(1)25$ ,  $n=0(1)15$ , 11S;  $\beta_n(x)$ ,  $x=.25(.25)8(.5)19(1)25$ ,  $n=0(1)8$ , 11S.
- [5.28] M. Mashiko, *Tables of generalized exponential-, sine- and cosine-integrals*, Numerical Computation Bureau Report No. 7, Tokyo, Japan (1953).  $E_1(z) + \ln |z| = C_n(\xi) + \ln \xi - iS_n(\xi)$ ,  $z = \xi e^{i\alpha}$ ,  $\xi = 0(.05)5$ ,  $\alpha = 0^\circ(2^\circ)60^\circ(1^\circ)90^\circ$ , 6D;  $ze^z E_1(z) = A_n(\eta) \exp[i\Phi_n(\eta)]$ ,  $z = \frac{1}{\eta} e^{i\alpha}$ ,  $\eta = .01(.01).2$ ,  $\alpha = 0^\circ(2^\circ)60^\circ(1^\circ)90^\circ$ , 5-6D.
- [5.29] G. F. Miller, *Tables of generalized exponential integrals*, *Mathematical Tables*, vol. 3, National Physical Laboratory (Her Majesty's Stationery Office, London, England, 1958).  $(x+n)e^xE_n(x)$ ,  $x=0(.01)1$ ,  $n=1(1)8$ ,  $x=0(.1)20$ ,  $n=1(1)24$ ,  $x^{-1}=0(.001).05$ ,  $n=1(1)24$ ; 8D.
- [5.30] J. Miller, J. M. Gerhauser, and F. A. Matsen, *Quantum chemistry integrals and tables* (Univ. of Texas Press, Austin, Tex., 1959).  $\alpha_n(x)$ ,  $x=.125(.125)25$ ,  $n=0(1)16$ , 14S;  $\beta_n(x)$ ,  $x=0(.125)24.875$ ,  $n=0(1)16$ , 12-14S.
- [5.31] J. Miller and R. P. Hurst, Simplified calculation of the exponential integral, *Math. Tables Aids Comp.* **12**, 187-193 (1958).  $e^{-x}Ei(x)$ ,  $Ei(x)$ ,  $e^xE_1(x)$ ,  $E_1(x)$ ,  $x=.2(.05)5(.1)10(.2)20(.5)50(1)80$ ; 16S.
- [5.32] National Bureau of Standards, *Tables of sine, cosine and exponential integrals*, vol. I (U.S. Government Printing Office, Washington, D.C., 1940).  $Si(x)$ ,  $Ci(x)$ ,  $Ei(x)$ ,  $E_1(x)$ ,  $x=0(.0001)2$ ,  $x=0(.1)10$ ; 9D.
- [5.33] National Bureau of Standards, *Tables of sine, cosine and exponential integrals*, vol. II (U.S. Government Printing Office, Washington, D.C., 1940).  $Si(x)$ ,  $Ci(x)$ ,  $Ei(x)$ ,  $E_1(x)$ ,  $x=0(.001)10$ , 9-10 D or S;  $Si(x)$ ,  $Ci(x)$ ,  $x=10(.1)40$ , 10D;  $Ei(x)$ ,  $E_1(x)$ ,  $x=10(.1)15$ , 7-11S.

- [5.34] National Bureau of Standards, Table of sine and cosine integrals for arguments from 10 to 100, Applied Math. Series 32 (U.S. Government Printing Office, Washington, D.C., 1954).  $\text{Si}(x)$ ,  $\text{Ci}(x)$ ,  $x=10(.01)100$ , 10D.
- [5.35] National Bureau of Standards, Tables of functions and of zeros of functions, Collected short tables of the Computation Laboratory, Applied Math. Series 37 (U.S. Government Printing Office, Washington, D.C., 1954).  $E_n(x)$ ,  $n=0(1)20$ ,  $x=0(.01)2(.1)10$ , 4-9S;  $E_2(x)-x \ln x$ ,  $x=0(.01).5$ , 7S;  $E_3(x)+\frac{1}{2}x^2 \ln x$ ,  $x=0(.01).1$ , 7S.
- [5.36] National Bureau of Standards, Tables of the exponential integral for complex arguments, Applied Math. Series 51 (U.S. Government Printing Office, Washington, D.C., 1958).  $E_1(z)+\ln z$ , 6D,  $x=0(.02)1$ ,  $y=0(.02)1$ ,  $x=-1(.1)0$ ,  $y=0(.1)1$ ;  $E_1(z)$ , 6D,  $x=0(.02)4$ ,  $y=0(.02)3(.05)10$ ,  $x=0(1)20$ ,  $y=0(1)20$ ,  $x=-3.1(.1)0$ ,  $y=0(.1)3.1$ ,  $x=-4.5(.5)0$ ,  $y=0(.1)4(.5)10$ ,  $x=-10(.5)-4.5$ ,  $y=0(.5)10$ ,  $x=-20(1)0$ ,  $y=0(1)20$ ;  $e^z E_1(z)$ , 6D,  $x=4(.1)10$ ,  $y=0(.5)10$ .
- [5.37] S. Oberländer, Tabellen von Exponentialfunktionen und-integralen zur Anwendung auf Gebieten der Thermodynamik, Halbleiterttheorie und Gaskinetik (Akademie-Verlag, Berlin, Germany, 1959).  $\frac{\Delta E}{kT}$ ,  $\frac{kT}{\Delta E}$ ,  $\exp\left(\frac{-\Delta E}{kT}\right)$ ,  $\frac{kT}{\Delta E} \exp\left(\frac{-\Delta E}{kT}\right)$ ,  $E_1\left(\frac{\Delta E}{kT}\right)$ ,  $\frac{k}{\Delta E} \int_0^T \exp\left(\frac{-\Delta E}{kT}\right) dT$ ,  $\frac{\Delta E}{kT} \exp\left(\frac{\Delta E}{kT}\right) \times$

$$E_1\left(\frac{\Delta E}{kT}\right), 1-\frac{\Delta E}{kT} \exp\left(\frac{\Delta E}{kT}\right) E_1\left(\frac{\Delta E}{kT}\right); \Delta E=.2(.2)2, T=25(25)1000, T=150(10)390, 3-4S; x^{-1}, \exp(-x^{-1}), x \exp(-x^{-1}), E_1(x^{-1}), \int_0^x \exp(-t^{-1}) dt, x^{-1} \exp(x^{-1}) E_1(x^{-1}), 1-x^{-1} \exp(x^{-1}) E_1(x^{-1}); x=.01(.0001).1, 5-6S.$$

- [5.38] V. I. Pagurova, Tables of the exponential integral  $E_\nu(x) = \int_1^\infty e^{-x^u} u^{-\nu} du$ . Translated from the Russian by D. G. Fry (Pergamon Press, New York, N.Y.; Oxford, London, England; Paris, France, 1961).  $E_n(x)$ ,  $n=0(1)20$ ,  $x=0(.01)2(.1)10$ , 4-9S;  $E_2(x)-x \ln x$ ,  $x=0(.01)5$ , 7S;  $E_3(x)+\frac{1}{2}x^2 \ln x$ ,  $x=0(.01).1$ , 7S;  $e^z E_n(x)$ ,  $n=2(1)10$ ,  $x=10(.1)20$ , 7D;  $e^z E_\nu(x)$ ,  $\nu=0(.1)1$ ,  $x=.01(.01)7(.05)12(.1)20$ , 7 S or D.
- [5.39] Tablitsy integral'nogo sinusa i kosinusa (Izdat. Akad. Nauk SSSR., Moscow, U.S.S.R., 1954).  $\text{Si}(x)$ ,  $\text{Ci}(x)$ ,  $x=0(.0001)2(.001)10(.005)100$ , 7D;  $\text{Ci}(x)-\ln x$ ,  $x=0(.0001).01$ , 7D.
- [5.40] Tablitsy integral'noi pokazatel'noi funktsii (Izdat. Akad. Nauk SSSR., Moscow, U.S.S.R., 1954).  $\text{Ei}(x)$ ,  $E_1(x)$ ,  $x=0(.0001)1.3(.001)3(.0005)10(.1)15$ , 7D.
- [5.41] D. K. Trubey, A table of three exponential integrals, Oak Ridge National Laboratory Report 2750, Oak Ridge, Tenn. (June 1959).  $E_1(x)$ ,  $E_2(x)$ ,  $E_3(x)$ ,  $x=0(.0005).1(.001)2(.01)10(.1)20$ , 6S.



# 6. Gamma Function and Related Functions

PHILIP J. DAVIS<sup>1</sup>

## Contents

|  | Page |
|--|------|
| <b>Mathematical Properties.</b> . . . . .  | 255  |
| <b>6.1. Gamma Function.</b> . . . . .  | 255  |
| <b>6.2. Beta Function</b> . . . . .  | 258  |
| <b>6.3. Psi (Digamma) Function.</b> . . . . .  | 258  |
| <b>6.4. Polygamma Functions.</b> . . . . .   | 260  |
| <b>6.5. Incomplete Gamma Function.</b> . . . . .   | 260  |
| <b>6.6. Incomplete Beta Function.</b> . . . . .  | 263  |
| <b>Numerical Methods</b> . . . . .   | 263  |
| <b>6.7. Use and Extension of the Tables.</b> . . . . .   | 263  |
| <b>6.8. Summation of Rational Series by Means of Polygamma Functions.</b> . . . . .  | 264  |
| <b>References.</b> . . . . .   | 265  |
| <b>Table 6.1. Gamma, Digamma and Trigamma Functions (<math>1 \leq x \leq 2</math>)</b> . . . . .                             | 267  |
| $\Gamma(x), \ln \Gamma(x), \psi(x), \psi'(x), x=1(.005)2, 10D$   |      |
| <b>Table 6.2. Tetragamma and Pentagamma Functions (<math>1 \leq x \leq 2</math>)</b> . . . . .                               | 271  |
| $\psi''(x), \psi^{(3)}(x), x=1(.01)2, 10D$   |      |
| <b>Table 6.3. Gamma and Digamma Functions for Integer and Half-Integer Values (<math>1 \leq n \leq 101</math>)</b> . . . . . | 272  |
| $\Gamma(n), 11S \quad \psi(n), 10D$  |      |
| $1/\Gamma(n), 9S \quad n!/[ (2\pi)^{\frac{1}{2}} n^{n+\frac{1}{2}} ] e^{-n}, 8D$   |      |
| $\Gamma(n+\frac{1}{2}), 8S \quad \ln n - \psi(n), 8D$  |      |
| $n=1(1)101$  |      |
| <b>Table 6.4. Logarithms of the Gamma Function (<math>1 \leq n \leq 101</math>)</b> . . . . .                                | 274  |
| $\log_{10} \Gamma(n), 8S \quad \log_{10} \Gamma(n+\frac{2}{3}), 8S$  |      |
| $\log_{10} \Gamma(n+\frac{1}{3}), 8S \quad \ln \Gamma(n) - (n-\frac{1}{2}) \ln n + n, 8D$                                    |      |
| $\log_{10} \Gamma(n+\frac{1}{2}), 8S$  |      |
| $n=1(1)101$  |      |

---

<sup>1</sup> National Bureau of Standards.



# 6. Gamma Function and Related Functions

## Mathematical Properties

### 6.1. Gamma (Factorial) Function

#### Euler's Integral

$$6.1.1 \quad \Gamma(z) = \int_0^{\infty} t^{z-1} e^{-t} dt \quad (\Re z > 0)$$

$$= k^z \int_0^{\infty} t^{z-1} e^{-kt} dt \quad (\Re z > 0, \Re k > 0)$$

#### Euler's Formula

$$6.1.2 \quad \Gamma(z) = \lim_{n \rightarrow \infty} \frac{n! n^z}{z(z+1) \dots (z+n)} \quad (z \neq 0, -1, -2, \dots)$$

#### Euler's Infinite Product

$$6.1.3 \quad \frac{1}{\Gamma(z)} = z e^{\gamma z} \prod_{n=1}^{\infty} \left[ \left( 1 + \frac{z}{n} \right) e^{-z/n} \right] \quad (|z| < \infty)$$

$$\gamma = \lim_{m \rightarrow \infty} \left[ 1 + \frac{1}{2} + \frac{1}{3} + \frac{1}{4} + \dots + \frac{1}{m} - \ln m \right]$$

$$= .57721\ 56649 \dots$$

$\gamma$  is known as Euler's constant and is given to 25 decimal places in chapter 1.  $\Gamma(z)$  is single valued and analytic over the entire complex plane, save for the points  $z = -n$  ( $n=0, 1, 2, \dots$ ) where it possesses simple poles with residue  $(-1)^n/n!$ . Its reciprocal  $1/\Gamma(z)$  is an entire function possessing simple zeros at the points  $z = -n$  ( $n=0, 1, 2, \dots$ ).

#### Hankel's Contour Integral

$$6.1.4 \quad \frac{1}{\Gamma(z)} = \frac{i}{2\pi} \int_C (-t)^{-z} e^{-t} dt \quad (|z| < \infty)$$

The path of integration  $C$  starts at  $+\infty$  on the real axis, circles the origin in the counterclockwise direction and returns to the starting point.

#### Factorial and $\Pi$ Notations

$$6.1.5 \quad \Pi(z) = z! = \Gamma(z+1)$$

#### Integer Values

$$6.1.6 \quad \Gamma(n+1) = 1 \cdot 2 \cdot 3 \dots (n-1)n = n!$$

#### 6.1.7

$$\lim_{z \rightarrow n} \frac{1}{\Gamma(-z)} = 0 = \frac{1}{(-n-1)!} \quad (n=0, 1, 2, \dots)$$

#### Fractional Values

$$6.1.8 \quad \Gamma\left(\frac{1}{2}\right) = 2 \int_0^{\infty} e^{-t^2} dt = \pi^{1/2} = 1.77245\ 38509 \dots = \left(-\frac{1}{2}\right)!$$

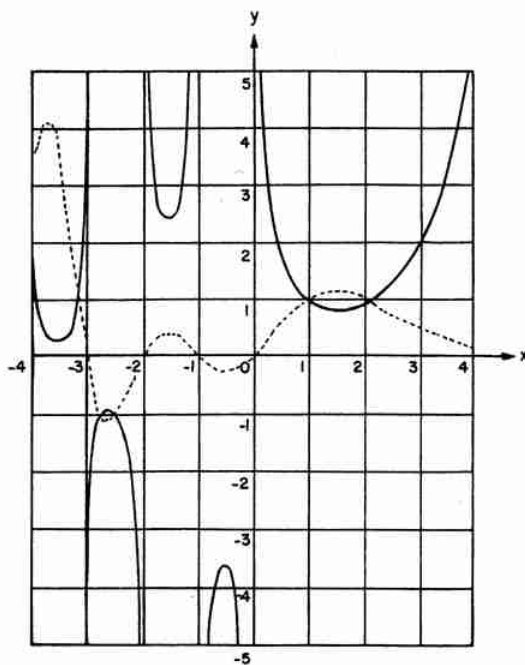

FIGURE 6.1. Gamma function. \*

—,  $y = \Gamma(x)$ , - - - - ,  $y = 1/\Gamma(x)$

$$6.1.9 \quad \Gamma(3/2) = \frac{1}{2} \pi^{1/2} = .88622\ 69254 \dots = \left(\frac{1}{2}\right)!$$

$$6.1.10 \quad \Gamma\left(n + \frac{1}{2}\right) = \frac{1 \cdot 3 \cdot 5 \cdot 7 \dots (2n-1)}{2^n} \Gamma\left(\frac{1}{2}\right)$$

$$\Gamma\left(\frac{1}{2}\right) = 3.62560\ 99082 \dots$$

$$6.1.11 \quad \Gamma\left(n + \frac{1}{3}\right) = \frac{1 \cdot 4 \cdot 7 \cdot 10 \dots (3n-2)}{3^n} \Gamma\left(\frac{1}{3}\right)$$

$$\Gamma\left(\frac{1}{3}\right) = 2.67893\ 85347 \dots$$

$$6.1.12 \quad \Gamma\left(n + \frac{1}{2}\right) = \frac{1 \cdot 3 \cdot 5 \cdot 7 \dots (2n-1)}{2^n} \Gamma\left(\frac{1}{2}\right)$$

$$6.1.13 \quad \Gamma\left(n + \frac{2}{3}\right) = \frac{2 \cdot 5 \cdot 8 \cdot 11 \dots (3n-1)}{3^n} \Gamma\left(\frac{2}{3}\right)$$

$$\Gamma\left(\frac{2}{3}\right) = 1.35411\ 79394 \dots$$

$$6.1.14 \quad \Gamma\left(n + \frac{3}{4}\right) = \frac{3 \cdot 7 \cdot 11 \cdot 15 \dots (4n-1)}{4^n} \Gamma\left(\frac{3}{4}\right)$$

$$\Gamma\left(\frac{3}{4}\right) = 1.22541\ 67024 \dots$$

\*See page II.



**Recurrence Formulas**

6.1.15  $\Gamma(z+1) = z\Gamma(z) = z! = z(z-1)!$

6.1.16

$$\begin{aligned} \Gamma(n+z) &= (n-1+z)(n-2+z) \dots (1+z)\Gamma(1+z) \\ &= (n-1+z)! \\ &= (n-1+z)(n-2+z) \dots (1+z)z! \end{aligned}$$

**Reflection Formula**

6.1.17  $\Gamma(z)\Gamma(1-z) = -z\Gamma(-z)\Gamma(z) = \pi \csc \pi z$

$$= \int_0^\infty \frac{t^{z-1}}{1+t} dt \quad (0 < \Re z < 1)$$

**Duplication Formula**

6.1.18  $\Gamma(2z) = (2\pi)^{-\frac{1}{2}} 2^{2z-\frac{1}{2}} \Gamma(z) \Gamma(z+\frac{1}{2})$

**TriPLICATION Formula**

6.1.19  $\Gamma(3z) = (2\pi)^{-1} 3^{3z-\frac{1}{2}} \Gamma(z) \Gamma(z+\frac{1}{3}) \Gamma(z+\frac{2}{3})$

**Gauss' Multiplication Formula**

6.1.20  $\Gamma(nz) = (2\pi)^{\frac{1}{2}(1-n)} n^{nz-\frac{1}{2}} \prod_{k=0}^{n-1} \Gamma\left(z+\frac{k}{n}\right)$

**Binomial Coefficient**

6.1.21  $\binom{z}{w} = \frac{z!}{w!(z-w)!} = \frac{\Gamma(z+1)}{\Gamma(w+1)\Gamma(z-w+1)}$

**Pochhammer's Symbol**

6.1.22

$(z)_0 = 1,$

$(z)_n = z(z+1)(z+2) \dots (z+n-1) = \frac{\Gamma(z+n)}{\Gamma(z)}$

**Gamma Function in the Complex Plane**

6.1.23  $\Gamma(\bar{z}) = \overline{\Gamma(z)}; \ln \Gamma(\bar{z}) = \overline{\ln \Gamma(z)}$

6.1.24  $\arg \Gamma(z+1) = \arg \Gamma(z) + \arctan \frac{y}{x}$

6.1.25  $\left| \frac{\Gamma(x+iy)}{\Gamma(x)} \right|^2 = \prod_{n=0}^\infty \left[ 1 + \frac{y^2}{(x+n)^2} \right]^{-1}$

6.1.26  $|\Gamma(x+iy)| \leq |\Gamma(x)|$

6.1.27

$$\arg \Gamma(x+iy) = y\psi(x) + \sum_{n=0}^\infty \left( \frac{y}{x+n} - \arctan \frac{y}{x+n} \right)$$

$(x+iy \neq 0, -1, -2, \dots)$

where  $\psi(z) = \Gamma'(z)/\Gamma(z)$

6.1.28  $\Gamma(1+iy) = iy \Gamma(iy)$

6.1.29  $\Gamma(iy)\Gamma(-iy) = |\Gamma(iy)|^2 = \frac{\pi}{y \sinh \pi y}$

6.1.30  $\Gamma(\frac{1}{2}+iy)\Gamma(\frac{1}{2}-iy) = |\Gamma(\frac{1}{2}+iy)|^2 = \frac{\pi}{\cosh \pi y}$

6.1.31  $\Gamma(1+iy)\Gamma(1-iy) = |\Gamma(1+iy)|^2 = \frac{\pi y}{\sinh \pi y}$

6.1.32  $\Gamma(\frac{1}{4}+iy)\Gamma(\frac{3}{4}-iy) = \frac{\pi\sqrt{2}}{\cosh \pi y + i \sinh \pi y}$

**Power Series**

6.1.33

$\ln \Gamma(1+z) = -\ln(1+z) + z(1-\gamma)$

$$+ \sum_{n=2}^\infty \frac{(-1)^n [\zeta(n)-1] z^n}{n} \quad (|z| < 2)$$

$\zeta(n)$  is the Riemann Zeta Function (see chapter 23).

**Series Expansion<sup>2</sup> for  $1/\Gamma(z)$**

6.1.34  $\frac{1}{\Gamma(z)} = \sum_{k=1}^\infty c_k z^k \quad (|z| < \infty)$

| $k$ | $c_k$                 |
|-----|-----------------------|
| 1   | 1.00000 00000 000000  |
| 2   | 0.57721 56649 015329  |
| 3   | -0.65587 80715 202538 |
| 4   | -0.04200 26350 340952 |
| 5   | 0.16653 86113 822915  |
| 6   | -0.04219 77345 555443 |
| 7   | -0.00962 19715 278770 |
| 8   | 0.00721 89432 466630  |
| 9   | -0.00116 51675 918591 |
| 10  | -0.00021 52416 741149 |
| 11  | 0.00012 80502 823882  |
| 12  | -0.00002 01348 547807 |
| 13  | -0.00000 12504 934821 |
| 14  | 0.00000 11330 272320  |
| 15  | -0.00000 02056 338417 |
| 16  | 0.00000 00061 160950  |
| 17  | 0.00000 00050 020075  |
| 18  | -0.00000 00011 812746 |
| 19  | 0.00000 00001 043427  |
| 20  | 0.00000 00000 077823  |
| 21  | -0.00000 00000 036968 |
| 22  | 0.00000 00000 005100  |
| 23  | -0.00000 00000 000206 |
| 24  | -0.00000 00000 000054 |
| 25  | 0.00000 00000 000014  |
| 26  | 0.00000 00000 000001  |

<sup>2</sup> The coefficients  $c_k$  are from H. T. Davis, Tables of higher mathematical functions, 2 vols., Principia Press, Bloomington, Ind., 1933, 1935 (with permission); with corrections due to H. E. Salzer.

Polynomial Approximations<sup>3</sup>

6.1.35  $0 \leq x \leq 1$

$$\Gamma(x+1) = x! = 1 + a_1x + a_2x^2 + a_3x^3 + a_4x^4 + a_5x^5 + \epsilon(x)$$

$$|\epsilon(x)| \leq 5 \times 10^{-5}$$

$$\begin{array}{ll} a_1 = -.57486\ 46 & a_4 = .42455\ 49 \\ a_2 = .95123\ 63 & a_5 = -.10106\ 78 \\ a_3 = -.69985\ 88 & \end{array}$$

6.1.36  $0 \leq x \leq 1$

$$\Gamma(x+1) = x! = 1 + b_1x + b_2x^2 + \dots + b_8x^8 + \epsilon(x)$$

$$|\epsilon(x)| \leq 3 \times 10^{-7}$$

$$\begin{array}{ll} b_1 = -.57719\ 1652 & b_5 = -.75670\ 4078 \\ b_2 = .98820\ 5891 & b_6 = .48219\ 9394 \\ b_3 = -.89705\ 6937 & b_7 = -.19352\ 7818 \\ b_4 = .91820\ 6857 & b_8 = .03586\ 8343 \end{array}$$

Stirling's Formula

6.1.37

$$\Gamma(z) \sim e^{-z} z^{z-\frac{1}{2}} (2\pi)^{\frac{1}{2}} \left[ 1 + \frac{1}{12z} + \frac{1}{288z^2} - \frac{139}{51840z^3} - \frac{571}{2488320z^4} + \dots \right] \quad (z \rightarrow \infty \text{ in } |\arg z| < \pi)$$

6.1.38

$$x! = \sqrt{2\pi} x^{x+\frac{1}{2}} \exp\left(-x + \frac{\theta}{12x}\right) \quad (x > 0, 0 < \theta < 1)$$

Asymptotic Formulas

6.1.39

$$\Gamma(az+b) \sim \sqrt{2\pi} e^{-az} (az)^{az+b-\frac{1}{2}} \quad (|\arg z| < \pi, a > 0)$$

6.1.40

$$\ln \Gamma(z) \sim (z - \frac{1}{2}) \ln z - z + \frac{1}{2} \ln(2\pi) + \sum_{m=1}^{\infty} \frac{B_{2m}}{2m(2m-1)z^{2m-1}} \quad (z \rightarrow \infty \text{ in } |\arg z| < \pi)$$

For  $B_n$  see chapter 23

6.1.41

$$\ln \Gamma(z) \sim (z - \frac{1}{2}) \ln z - z + \frac{1}{2} \ln(2\pi) + \frac{1}{12z} - \frac{1}{360z^3} + \frac{1}{1260z^5} - \frac{1}{1680z^7} + \dots \quad (z \rightarrow \infty \text{ in } |\arg z| < \pi)$$

<sup>3</sup> From C. Hastings, Jr., Approximations for digital computers, Princeton Univ. Press, Princeton, N.J., 1955 (with permission).

Error Term for Asymptotic Expansion

6.1.42

If

$$R_n(z) = \ln \Gamma(z) - (z - \frac{1}{2}) \ln z - z + \frac{1}{2} \ln(2\pi)$$

$$- \sum_{m=1}^n \frac{B_{2m}}{2m(2m-1)z^{2m-1}}$$

then

$$|R_n(z)| \leq \frac{|B_{2n+2}|K(z)}{(2n+1)(2n+2)|z|^{2n+1}}$$

where

$$K(z) = \text{upper bound } |z^2/(u^2+z^2)|_{u \geq 0}$$

For  $z$  real and positive,  $R_n$  is less in absolute value than the first term neglected and has the same sign.

6.1.43

$$\begin{aligned} \mathcal{R} \ln \Gamma(iy) &= \mathcal{R} \ln \Gamma(-iy) \\ &= \frac{1}{2} \ln \left( \frac{\pi}{y \sinh \pi y} \right) \\ &\sim \frac{1}{2} \ln(2\pi) - \frac{1}{2} \pi y - \frac{1}{2} \ln y, \quad (y \rightarrow +\infty) \end{aligned}$$

6.1.44

$$\begin{aligned} \mathcal{I} \ln \Gamma(iy) &= \arg \Gamma(iy) = -\arg \Gamma(-iy) \\ &= -\mathcal{I} \ln \Gamma(-iy) \\ &\sim y \ln y - y - \frac{1}{4} \pi - \sum_{n=1}^{\infty} \frac{(-1)^{n-1} B_{2n}}{(2n-1)(2n)y^{2n-1}} \quad (y \rightarrow +\infty) \end{aligned}$$

6.1.45  $\lim_{|y| \rightarrow \infty} (2\pi)^{-\frac{1}{2}} |\Gamma(x+iy)| e^{\frac{1}{2}\pi|y|} |y|^{\frac{1}{2}-x} = 1$

6.1.46  $\lim_{n \rightarrow \infty} n^{b-a} \frac{\Gamma(n+a)}{\Gamma(n+b)} = 1$

6.1.47

$$\begin{aligned} z^{b-a} \frac{\Gamma(z+a)}{\Gamma(z+b)} &\sim 1 + \frac{(a-b)(a+b-1)}{2z} \\ &\quad + \frac{1}{12} \binom{a-b}{2} (3(a+b-1)^2 - a+b-1) \frac{1}{z^2} + \dots \end{aligned}$$

as  $z \rightarrow \infty$  along any curve joining  $z=0$  and  $z=\infty$ , providing  $z \neq -a, -a-1, \dots; z \neq -b, -b-1, \dots$

**Continued Fraction**

**6.1.48**

$$\begin{aligned} \ln \Gamma(z) + z - (z - \frac{1}{2}) \ln z - \frac{1}{2} \ln(2\pi) \\ = \frac{a_0}{z +} \frac{a_1}{z +} \frac{a_2}{z +} \frac{a_3}{z +} \frac{a_4}{z +} \frac{a_5}{z +} \dots \quad (\Re z > 0) \\ a_0 = \frac{1}{12}, a_1 = \frac{1}{30}, a_2 = \frac{53}{210}, a_3 = \frac{195}{371}, \\ a_4 = \frac{22999}{22737}, a_5 = \frac{29944523}{19733142}, a_6 = \frac{109535241009}{48264275462} \end{aligned}$$

**Wallis' Formula<sup>4</sup>**

**6.1.49**

$$\begin{aligned} \frac{2}{\pi} \int_0^{\pi/2} (\frac{\sin x}{\cos x})^{2n} x dx &= \frac{1 \cdot 3 \cdot 5 \dots (2n-1)}{2 \cdot 4 \cdot 6 \dots (2n)} \\ &= \frac{(2n)!}{2^{2n} (n!)^2} = \frac{1}{2^{2n}} \binom{2n}{n} = \frac{\Gamma(n + \frac{1}{2})}{\pi^{1/2} \Gamma(n+1)} \\ &\sim \frac{1}{\pi^{1/2} n^{1/2}} \left[ 1 - \frac{1}{8n} + \frac{1}{128n^2} - \dots \right] \quad (n \rightarrow \infty) \end{aligned}$$

**Some Definite Integrals**

**6.1.50**

$$\begin{aligned} \ln \Gamma(z) &= \int_0^\infty \left[ (z-1) e^{-t} - \frac{e^{-t} - e^{-zt}}{1 - e^{-t}} \right] \frac{dt}{t} \quad (\Re z > 0) \\ &= (z - \frac{1}{2}) \ln z - z + \frac{1}{2} \ln 2\pi \\ &\quad + 2 \int_0^\infty \frac{\arctan(t/z)}{e^{2\pi t} - 1} dt \quad (\Re z > 0) \end{aligned}$$

**6.2. Beta Function**

**6.2.1**

$$\begin{aligned} B(z, w) &= \int_0^1 t^{z-1} (1-t)^{w-1} dt = \int_0^\infty \frac{t^{z-1}}{(1+t)^{z+w}} dt \\ &= 2 \int_0^{\pi/2} (\sin t)^{2z-1} (\cos t)^{2w-1} dt \\ &\quad (\Re z > 0, \Re w > 0) \end{aligned}$$

**6.2.2** 
$$B(z, w) = \frac{\Gamma(z)\Gamma(w)}{\Gamma(z+w)} = B(w, z)$$

**6.3. Psi (Digamma) Function<sup>5</sup>**

**6.3.1** 
$$\psi(z) = d[\ln \Gamma(z)]/dz = \Gamma'(z)/\Gamma(z)$$

<sup>4</sup> Some authors employ the special double factorial notation as follows:

$$\begin{aligned} (2n) !! &= 2 \cdot 4 \cdot 6 \dots (2n) = 2^n n! \\ (2n-1) !! &= 1 \cdot 3 \cdot 5 \dots (2n-1) = \pi^{-1/2} 2^n \Gamma(n + \frac{1}{2}) \end{aligned}$$

<sup>5</sup> Some authors write  $\psi(z) = \frac{d}{dz} \ln \Gamma(z+1)$  and similarly for the polygamma functions.

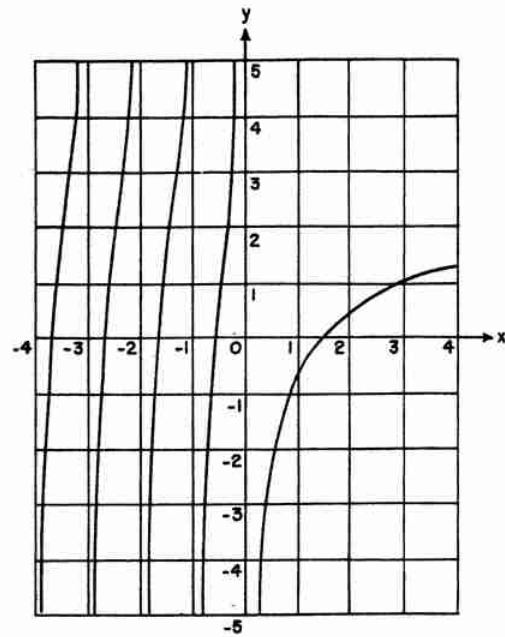

FIGURE 6.2. Psi function.

$$y = \psi(x) = d \ln \Gamma(x) / dx$$

**Integer Values**

**6.3.2** 
$$\psi(1) = -\gamma, \psi(n) = -\gamma + \sum_{k=1}^{n-1} k^{-1} \quad (n \geq 2)$$

**Fractional Values**

**6.3.3**

$$\psi(\frac{1}{2}) = -\gamma - 2 \ln 2 = -1.96351 00260 21423 \dots$$

**6.3.4**

$$\psi(n + \frac{1}{2}) = -\gamma - 2 \ln 2 + 2 \left( 1 + \frac{1}{3} + \dots + \frac{1}{2n-1} \right) \quad (n \geq 1)$$

**Recurrence Formulas**

**6.3.5**

$$\psi(z+1) = \psi(z) + \frac{1}{z}$$

**6.3.6**

$$\begin{aligned} \psi(n+z) &= \frac{1}{(n-1)+z} + \frac{1}{(n-2)+z} + \dots \\ &\quad + \frac{1}{2+z} + \frac{1}{1+z} + \psi(1+z) \end{aligned}$$

Reflection Formula

6.3.7  $\psi(1-z) = \psi(z) + \pi \cot \pi z$

Duplication Formula

6.3.8  $\psi(2z) = \frac{1}{2}\psi(z) + \frac{1}{2}\psi(z + \frac{1}{2}) + \ln 2$

Psi Function in the Complex Plane

6.3.9  $\psi(\bar{z}) = \overline{\psi(z)}$

6.3.10  $\Re \psi(iy) = \Re \psi(-iy) = \Re \psi(1+iy) = \Re \psi(1-iy)$

6.3.11  $\Im \psi(iy) = \frac{1}{2}y^{-1} + \frac{1}{2}\pi \coth \pi y$

6.3.12  $\Im \psi(\frac{1}{2} + iy) = \frac{1}{2}\pi \tanh \pi y$

6.3.13  $\Im \psi(1+iy) = -\frac{1}{2y} + \frac{1}{2}\pi \coth \pi y$   
 $= y \sum_{n=1}^{\infty} (n^2 + y^2)^{-1}$

Series Expansions

6.3.14  $\psi(1+z) = -\gamma + \sum_{n=2}^{\infty} (-1)^n \zeta(n) z^{n-1} \quad (|z| < 1)$

6.3.15  $\psi(1+z) = \frac{1}{2}z^{-1} - \frac{1}{2}\pi \cot \pi z - (1-z^2)^{-1} + 1 - \gamma$   
 $- \sum_{n=1}^{\infty} [\zeta(2n+1) - 1] z^{2n} \quad (|z| < 2)$

6.3.16  $\psi(1+z) = -\gamma + \sum_{n=1}^{\infty} \frac{z}{n(n+z)} \quad (z \neq -1, -2, -3, \dots)$

6.3.17  $\Re \psi(1+iy) = 1 - \gamma - \frac{1}{1+y^2}$   
 $+ \sum_{n=1}^{\infty} (-1)^{n+1} [\zeta(2n+1) - 1] y^{2n}$   
 $= -\gamma + y^2 \sum_{n=1}^{\infty} n^{-1} (n^2 + y^2)^{-1}$   
 $(-\infty < y < \infty)$

Asymptotic Formulas

6.3.18  $\psi(z) \sim \ln z - \frac{1}{2z} - \sum_{n=1}^{\infty} \frac{B_{2n}}{2nz^{2n}}$   
 $= \ln z - \frac{1}{2z} - \frac{1}{12z^2} + \frac{1}{120z^4} - \frac{1}{252z^6} + \dots$   
 $(z \rightarrow \infty \text{ in } |\arg z| < \pi)$

6.3.19

$$\Re \psi(1+iy) \sim \ln y + \sum_{n=1}^{\infty} \frac{(-1)^{n-1} B_{2n}}{2ny^{2n}}$$

$$= \ln y + \frac{1}{12y^2} + \frac{1}{120y^4} + \frac{1}{252y^6} + \dots$$

$(y \rightarrow \infty)$

Extrema<sup>6</sup> of  $\Gamma(x)$  — Zeros of  $\psi(x)$

$\Gamma'(x_n) = \psi(x_n) = 0$

| $n$ | $x_n$  | $\Gamma(x_n)$ |
|-----|--------|---------------|
| 0   | +1.462 | +0.886        |
| 1   | -0.504 | -3.545        |
| 2   | -1.573 | +2.302        |
| 3   | -2.611 | -0.888        |
| 4   | -3.635 | +0.245        |
| 5   | -4.653 | -0.053        |
| 6   | -5.667 | +0.009        |
| 7   | -6.678 | -0.001        |

$x_0 = 1.46163 \quad 21449 \quad 68362$

$\Gamma(x_0) = .88560 \quad 31944 \quad 10889$

6.3.20  $x_n = -n + (\ln n)^{-1} + o[(\ln n)^{-2}]$

Definite Integrals

6.3.21  $\psi(z) = \int_0^{\infty} \left[ \frac{e^{-t}}{t} - \frac{e^{-zt}}{1-e^{-t}} \right] dt \quad (\Re z > 0)$   
 $= \int_0^{\infty} \left[ e^{-t} - \frac{1}{(1+t)^z} \right] \frac{dt}{t}$   
 $= \ln z - \frac{1}{2z} - 2 \int_0^{\infty} \frac{t dt}{(t^2+z^2)(e^{2\pi t}-1)}$   
 $(|\arg z| < \frac{\pi}{2})$

6.3.22  $\psi(z) + \gamma = \int_0^{\infty} \frac{e^{-t} - e^{-zt}}{1-e^{-t}} dt = \int_0^1 \frac{1-t^{z-1}}{1-t} dt$   
 $\gamma = \int_0^{\infty} \left( \frac{1}{e^t-1} - \frac{1}{te^t} \right) dt$   
 $= \int_0^{\infty} \left( \frac{1}{1+t} - e^{-t} \right) \frac{dt}{t}$

<sup>6</sup> From W. Sibagaki, Theory and applications of the gamma function, Iwanami Syoten, Tokyo, Japan, 1952 (with permission).

6.4. Polygamma Functions<sup>7</sup>

## 6.4.1

$$\psi^{(n)}(z) = \frac{d^n}{dz^n} \psi(z) = \frac{d^{n+1}}{dz^{n+1}} \ln \Gamma(z) \quad (n=1, 2, 3, \dots)$$

$$* \quad = (-1)^{n+1} \int_0^\infty \frac{t^n e^{-zt}}{1-e^{-t}} dt \quad (\Re z > 0)$$

$\psi^{(n)}(z)$ , ( $n=0, 1, \dots$ ), is a single valued analytic function over the entire complex plane save at the points  $z = -m$  ( $m=0, 1, 2, \dots$ ) where it possesses poles of order  $(n+1)$ .

## Integer Values

## 6.4.2

$$\psi^{(n)}(1) = (-1)^{n+1} n! \zeta(n+1) \quad (n=1, 2, 3, \dots)$$

## 6.4.3

$$\psi^{(m)}(n+1) = (-1)^m m! \left[ -\zeta(m+1) + 1 + \frac{1}{2^{m+1}} + \dots + \frac{1}{n^{m+1}} \right]$$

## Fractional Values

## 6.4.4

$$\psi^{(n)}\left(\frac{1}{2}\right) = (-1)^{n+1} n! (2^{n+1} - 1) \zeta(n+1) \quad (n=1, 2, \dots)$$

## 6.4.5

$$\psi'(n + \frac{1}{2}) = \frac{1}{2} \pi^2 - 4 \sum_{k=1}^n (2k-1)^{-2}$$

## Recurrence Formula

## 6.4.6

$$\psi^{(n)}(z+1) = \psi^{(n)}(z) + (-1)^n n! z^{-n-1}$$

## Reflection Formula

## 6.4.7

$$\psi^{(n)}(1-z) + (-1)^{n+1} \psi^{(n)}(z) = (-1)^n \pi \frac{d^n}{dz^n} \cot \pi z$$

## Multiplication Formula

## 6.4.8

$$* \quad \psi^{(n)}(mz) = \delta \ln m + \frac{1}{m^{n+1}} \sum_{k=0}^{m-1} \psi^{(n)}\left(z + \frac{k}{m}\right)$$

$$\delta = 1, \quad n = 0$$

$$\delta = 0, \quad n > 0$$

<sup>7</sup>  $\psi'$  is known as the trigamma function.  $\psi''$ ,  $\psi^{(3)}$ ,  $\psi^{(4)}$  are the tetra-, penta-, and hexagramma functions respectively. Some authors write  $\psi(z) = d[\ln \Gamma(z+1)]/dz$ , and similarly for the polygamma functions.

\*See page II.

## Series Expansions

## 6.4.9

$$\psi^{(n)}(1+z) = (-1)^{n+1} \left[ n! \zeta(n+1) - \frac{(n+1)!}{1!} \zeta(n+2)z + \frac{(n+2)!}{2!} \zeta(n+3)z^2 - \dots \right] \quad (|z| < 1)$$

## 6.4.10

$$\psi^{(n)}(z) = (-1)^{n+1} n! \sum_{k=0}^{\infty} (z+k)^{-n-1} \quad (z \neq 0, -1, -2, \dots)$$

## Asymptotic Formulas

## 6.4.11

$$\psi^{(n)}(z) \sim (-1)^{n-1} \left[ \frac{(n-1)!}{z^n} + \frac{n!}{2z^{n+1}} + \sum_{k=1}^{\infty} B_{2k} \frac{(2k+n-1)!}{(2k)! z^{2k+n}} \right] \quad (z \rightarrow \infty \text{ in } |\arg z| < \pi)$$

## 6.4.12

$$\psi'(z) \sim \frac{1}{z} + \frac{1}{2z^2} + \frac{1}{6z^3} - \frac{1}{30z^5} + \frac{1}{42z^7} - \frac{1}{30z^9} + \dots \quad (z \rightarrow \infty \text{ in } |\arg z| < \pi)$$

## 6.4.13

$$\psi''(z) \sim -\frac{1}{z^2} - \frac{1}{z^3} - \frac{1}{2z^4} + \frac{1}{6z^6} - \frac{1}{6z^8} + \frac{3}{10z^{10}} - \frac{5}{6z^{12}} + \dots \quad (z \rightarrow \infty \text{ in } |\arg z| < \pi)$$

## 6.4.14

$$\psi^{(3)}(z) \sim \frac{2}{z^3} + \frac{3}{z^4} + \frac{2}{z^5} - \frac{1}{z^7} + \frac{4}{3z^9} - \frac{3}{z^{11}} + \frac{10}{z^{13}} - \dots \quad (z \rightarrow \infty \text{ in } |\arg z| < \pi)$$

6.5. Incomplete Gamma Function  
(see also 26.4)

## 6.5.1

$$P(a, x) = \frac{1}{\Gamma(a)} \int_0^x e^{-t} t^{a-1} dt \quad (\Re a > 0)$$

## 6.5.2

$$\gamma(a, x) = P(a, x) \Gamma(a) = \int_0^x e^{-t} t^{a-1} dt \quad (\Re a > 0)$$

## 6.5.3

$$\Gamma(a, x) = \Gamma(a) - \gamma(a, x) = \int_x^\infty e^{-t} t^{a-1} dt$$

## 6.5.4

$$\gamma^*(a, x) = x^{-a} P(a, x) = \frac{x^{-a}}{\Gamma(a)} \gamma(a, x)$$

$\gamma^*$  is a single valued analytic function of  $a$  and  $x$  possessing no finite singularities.

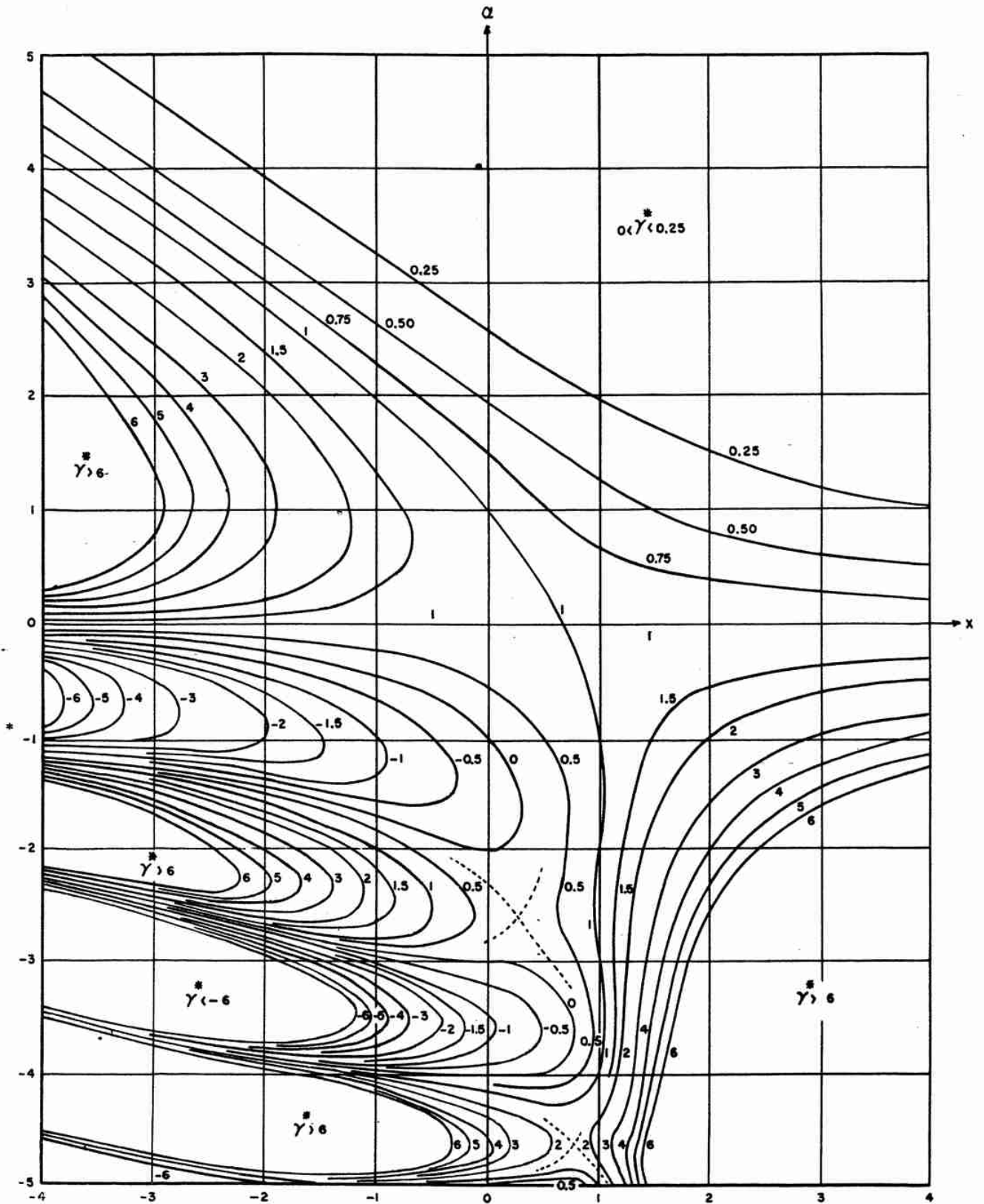

FIGURE 6.3. *Incomplete gamma function.*

$$\gamma^*(a, x) = \frac{x^{-a}}{\Gamma(a)} \int_0^x e^{-t} t^{a-1} dt$$

From F. G. Tricomi, Sulla funzione gamma incompleta, *Annali di Matematica*, IV, 33, 1950 (with permission).

\*See page II.

## 6.5.5

Probability Integral of the  $\chi^2$ -Distribution

$$P(\chi^2|v) = \frac{1}{2^{\frac{1}{2}v}\Gamma\left(\frac{v}{2}\right)} \int_0^{\chi^2} t^{\frac{1}{2}v-1} e^{-\frac{t}{2}} dt$$

## 6.5.6

(Pearson's Form of the Incomplete Gamma Function)

$$I(u, p) = \frac{1}{\Gamma(p+1)} \int_0^{u\sqrt{p+1}} e^{-t} t^p dt \\ = P(p+1, u\sqrt{p+1})$$

$$6.5.7 \quad C(x, a) = \int_x^\infty t^{a-1} \cos t dt \quad (\Re a < 1)$$

$$6.5.8 \quad S(x, a) = \int_x^\infty t^{a-1} \sin t dt \quad (\Re a < 1)$$

## 6.5.9

$$E_n(x) = \int_1^\infty e^{-xt} t^{-n} dt = x^{n-1} \Gamma(1-n, x)$$

## 6.5.10

$$\alpha_n(x) = \int_1^\infty e^{-xt} t^n dt = x^{-n-1} \Gamma(1+n, x)$$

## 6.5.11

$$e_n(x) = \sum_{j=0}^n \frac{x^j}{j!}$$

Incomplete Gamma Function as a Confluent Hypergeometric Function (see chapter 13)

$$6.5.12 \quad \gamma(a, x) = a^{-1} x^a e^{-x} M(1, 1+a, x) \\ = a^{-1} x^a M(a, 1+a, -x)$$

Special Values

## 6.5.13

$$P(n, x) = 1 - \left(1 + x + \frac{x^2}{2!} + \dots + \frac{x^{n-1}}{(n-1)!}\right) e^{-x} \\ = 1 - e_{n-1}(x) e^{-x}$$

For relation to the Poisson distribution, see 26.4.

$$6.5.14 \quad \gamma^*(-n, x) = x^n$$

$$6.5.15 \quad \Gamma(0, x) = \int_x^\infty e^{-t} t^{-1} dt = E_1(x)$$

$$6.5.16 \quad \gamma\left(\frac{1}{2}, x^2\right) = 2 \int_0^x e^{-t^2} dt = \sqrt{\pi} \operatorname{erf} x$$

$$6.5.17 \quad \Gamma\left(\frac{1}{2}, x^2\right) = 2 \int_x^\infty e^{-t^2} dt = \sqrt{\pi} \operatorname{erfc} x$$

$$6.5.18 \quad \frac{1}{2}\sqrt{\pi} x \gamma^*\left(\frac{1}{2}, -x^2\right) = \int_0^x e^{t^2} dt$$

$$6.5.19 \quad \Gamma(-n, x) = \frac{(-1)^n}{n!} \left[ E_1(x) - e^{-x} \sum_{j=0}^{n-1} \frac{(-1)^j j!}{x^{j+1}} \right]$$

$$6.5.20 \quad \Gamma(a, ix) = e^{\frac{1}{2}\pi ia} [C(x, a) - iS(x, a)]$$

Recurrence Formulas

$$6.5.21 \quad P(a+1, x) = P(a, x) - \frac{x^a e^{-x}}{\Gamma(a+1)}$$

$$6.5.22 \quad \gamma(a+1, x) = a\gamma(a, x) - x^a e^{-x}$$

$$6.5.23 \quad \gamma^*(a-1, x) = x\gamma^*(a, x) + \frac{e^{-x}}{\Gamma(a)}$$

Derivatives and Differential Equations

## 6.5.24

$$\left(\frac{\partial \gamma^*}{\partial a}\right)_{a=0} = - \int_x^\infty \frac{e^{-t} dt}{t} - \ln x = -E_1(x) - \ln x$$

$$6.5.25 \quad \frac{\partial \gamma(a, x)}{\partial x} = - \frac{\partial \Gamma(a, x)}{\partial x} = x^{a-1} e^{-x}$$

## 6.5.26

$$\frac{\partial^n}{\partial x^n} [x^{-a} \Gamma(a, x)] = (-1)^n x^{-a-n} \Gamma(a+n, x) \\ (n=0, 1, 2, \dots)$$

## 6.5.27

$$\frac{\partial^n}{\partial x^n} [e^x x^a \gamma^*(a, x)] = e^x x^{a-n} \gamma^*(a-n, x) \\ (n=0, 1, 2, \dots)$$

$$6.5.28 \quad x \frac{\partial^2 \gamma^*}{\partial x^2} + (a+1+x) \frac{\partial \gamma^*}{\partial x} + a\gamma^* = 0$$

Series Developments

## 6.5.29

$$\gamma^*(a, z) = e^{-z} \sum_{n=0}^{\infty} \frac{z^n}{\Gamma(a+n+1)} = \frac{1}{\Gamma(a)} \sum_{n=0}^{\infty} \frac{(-z)^n}{(a+n)n!} \\ (|z| < \infty)$$



6.5.30

$$\begin{aligned} \gamma(a, x+y) - \gamma(a, x) &= e^{-x} x^{a-1} \sum_{n=0}^{\infty} \frac{(a-1)(a-2)\dots(a-n)}{x^n} [1 - e^{-y} e_n(y)] \\ &\quad (|y| < |x|) \end{aligned}$$

Continued Fraction

6.5.31

$$\begin{aligned} \Gamma(a, x) = e^{-x} x^a \left( \frac{1}{x+1} \frac{1-a}{1+x} \frac{1}{x+1} \frac{2-a}{1+x} \frac{2}{x+1} \dots \right) \\ (x > 0, |a| < \infty) \end{aligned}$$

Asymptotic Expansions

6.5.32

$$\begin{aligned} \Gamma(a, z) \sim z^{a-1} e^{-z} \left[ 1 + \frac{a-1}{z} + \frac{(a-1)(a-2)}{z^2} + \dots \right] \\ (z \rightarrow \infty \text{ in } |\arg z| < \frac{3\pi}{2}) \end{aligned}$$

Suppose  $R_n(a, z) = u_{n+1}(a, z) + \dots$  is the remainder after  $n$  terms in this series. Then if  $a, z$  are real, we have for  $n > a - 2$

$$|R_n(a, z)| \leq |u_{n+1}(a, z)|$$

and  $\text{sign } R_n(a, z) = \text{sign } u_{n+1}(a, z)$ .

$$6.5.33 \quad \gamma(a, z) \sim \sum_{n=0}^{\infty} \frac{(-1)^n z^{a+n}}{(a+n)n!} \quad (a \rightarrow +\infty)$$

$$6.5.34 \quad \lim_{n \rightarrow \infty} \frac{e_n(\alpha n)}{e^{\alpha n}} = \begin{cases} 0 & \text{for } \alpha > 1 \\ \frac{1}{2} & \text{for } \alpha = 1 \\ 1 & \text{for } 0 \leq \alpha < 1 \end{cases}$$

6.5.35

$$\begin{aligned} \Gamma(z+1, z) \sim e^{-z} z^z \left( \sqrt{\frac{\pi}{2}} z^{\frac{1}{2}} + \frac{2}{3} + \frac{\sqrt{2\pi}}{24} \frac{1}{z^{\frac{1}{2}}} + \dots \right) \\ (z \rightarrow \infty \text{ in } |\arg z| < \frac{1}{2}\pi) \end{aligned}$$

Numerical Methods

6.7. Use and Extension of the Tables

**Example 1.** Compute  $\Gamma(6.38)$  to 8S. Using the recurrence relation 6.1.16 and Table 6.1 we have,

$$\begin{aligned} \Gamma(6.38) &= [(5.38)(4.38)(3.38)(2.38)(1.38)]\Gamma(1.38) \\ &= 232.43671. \end{aligned}$$

**Example 2.** Compute  $\ln \Gamma(56.38)$ , using Table 6.4 and linear interpolation in  $f_2$ . We have

$$\begin{aligned} \ln \Gamma(56.38) &= (56.38 - \frac{1}{2}) \ln(56.38) - (56.38) \\ &\quad + f_2(56.38) \end{aligned}$$

Definite Integrals

6.5.36

$$\begin{aligned} \int_0^{\infty} e^{-at} \Gamma(b, ct) dt = \frac{\Gamma(b)}{a} \left[ 1 - \frac{c^b}{(a+c)^b} \right] \\ (\Re(a+c) > 0, \Re b > -1) \end{aligned} \quad *$$

6.5.37

$$\begin{aligned} \int_0^{\infty} t^{a-1} \Gamma(b, t) dt = \frac{\Gamma(a+b)}{a} \\ (\Re(a+b) > 0, \Re a > 0) \end{aligned}$$

6.6. Incomplete Beta Function

$$6.6.1 \quad B_x(a, b) = \int_0^x t^{a-1} (1-t)^{b-1} dt$$

$$6.6.2 \quad I_x(a, b) = B_x(a, b) / B(a, b)$$

For statistical applications, see 26.5.

Symmetry

$$6.6.3 \quad I_x(a, b) = 1 - I_{1-x}(b, a)$$

Relation to Binomial Expansion

$$6.6.4 \quad I_p(a, n-a+1) = \sum_{j=a}^n \binom{n}{j} p^j (1-p)^{n-j}$$

For binomial distribution, see 26.1.

Recurrence Formulas

$$6.6.5 \quad I_x(a, b) = x I_x(a-1, b) + (1-x) I_x(a, b-1)$$

$$6.6.6 \quad (a+b-ax) I_x(a, b) = a(1-x) I_x(a+1, b-1) + b I_x(a, b+1) \quad *$$

$$6.6.7 \quad (a+b) I_x(a, b) = a I_x(a+1, b) + b I_x(a, b+1)$$

Relation to Hypergeometric Function

$$6.6.8 \quad B_x(a, b) = a^{-1} x^a F(a, 1-b; a+1; x)$$

The error of linear interpolation in the table of the function  $f_2$  is smaller than  $10^{-7}$  in this region. Hence,  $f_2(56.38) = .9204167$  and  $\ln \Gamma(56.38) = 169.8549742$ .

Direct interpolation in Table 6.4 of  $\log_{10} \Gamma(n)$  eliminates the necessity of employing logarithms. However, the error of linear interpolation is .002 so that  $\log_{10} \Gamma(n)$  is obtained with a relative error of  $10^{-5}$ .

\*See page 11.

**Example 3.** Compute  $\psi(6.38)$  to 8S. Using the recurrence relation 6.3.6 and Table 6.1.

$$\begin{aligned} \psi(6.38) &= \frac{1}{5.38} + \frac{1}{4.38} + \frac{1}{3.38} + \frac{1}{2.38} + \frac{1}{1.38} + \psi(1.38) \\ &= 1.77275\ 59. \end{aligned}$$

**Example 4.** Compute  $\psi(56.38)$ . Using Table 6.3 we have  $\psi(56.38) = \ln 56.38 - f_3(56.38)$ .

The error of linear interpolation in the table of the function  $f_3$  is smaller than  $8 \times 10^{-7}$  in this region. Hence,  $f_3(56.38) = .00889\ 53$  and  $\psi(56.38) = 4.023219$ .

**Example 5.** Compute  $\ln \Gamma(1-i)$ . From the reflection principle 6.1.23 and Table 6.7,  $\ln \Gamma(1-i) = \overline{\ln \Gamma(1+i)} = -.6509 + .3016i$ .

**Example 6.** Compute  $\ln \Gamma(\frac{1}{2} + \frac{1}{2}i)$ . Taking the logarithm of the recurrence relation 6.1.15 we have,

$$\begin{aligned} \ln \Gamma(\frac{1}{2} + \frac{1}{2}i) &= \ln \Gamma(\frac{3}{2} + \frac{1}{2}i) - \ln(\frac{1}{2} + \frac{1}{2}i) \\ &= -.23419 + .03467i \\ &\quad - (\frac{1}{2} \ln \frac{1}{2} + i \arctan 1) \\ &= .11239 - .75073i \end{aligned}$$

The logarithms of complex numbers are found from 4.1.2.

**Example 7.** Compute  $\ln \Gamma(3+7i)$  using the duplication formula 6.1.18. Taking the logarithm of 6.1.18, we have

$$\begin{aligned} -\frac{1}{2} \ln 2\pi &= -.91894 \\ (\frac{3}{2} + 7i) \ln 2 &= 1.73287 + 4.85203i \\ \ln \Gamma(\frac{3}{2} + \frac{7}{2}i) &= -3.31598 + 2.32553i \\ \ln \Gamma(2 + \frac{7}{2}i) &= -2.66047 + 2.93869i \\ \ln \Gamma(3+7i) &= -5.16252 + 10.11625i \end{aligned}$$

**Example 8.** Compute  $\ln \Gamma(3+7i)$  to 5D using the asymptotic formula 6.1.41. We have

$$\ln(3+7i) = 2.03022\ 15 + 1.16590\ 45i.$$

Then,

$$\begin{aligned} (2.5+7i) \ln(3+7i) &= -3.0857779 + 17.1263119i \\ -(3+7i) &= -3.0000000 - 7.0000000i \\ \frac{1}{2} \ln(2\pi) &= .9189385 \\ [12(3+7i)]^{-1} &= .0043103 - .0100575i \\ -[360(3+7i)^3]^{-1} &= .0000059 - .0000022i \end{aligned}$$

---

$$\ln \Gamma(3+7i) = -5.16252 + 10.11625i$$

### 6.8. Summation of Rational Series by Means of Polygamma Functions

An infinite series whose general term is a rational function of the index may always be reduced to a finite series of psi and polygamma functions. The method will be illustrated by writing the explicit formula when the denominator contains a triple root.

Let the general term of an infinite series have the form

$$u_n = \frac{p(n)}{d_1(n)d_2(n)d_3(n)}$$

where

$$\begin{aligned} d_1(n) &= (n+\alpha_1)(n+\alpha_2) \dots (n+\alpha_m) \\ d_2(n) &= (n+\beta_1)^2(n+\beta_2)^2 \dots (n+\beta_r)^2 \\ d_3(n) &= (n+\gamma_1)^3(n+\gamma_2)^3 \dots (n+\gamma_s)^3 \end{aligned}$$

where  $p(n)$  is a polynomial of degree  $m+2r+3s-2$  at most and where the constants  $\alpha_i, \beta_i,$  and  $\gamma_i$  are distinct. Expand  $u_n$  in partial fractions as follows

$$\begin{aligned} u_n &= \sum_{k=1}^m \frac{a_k}{(n+\alpha_k)} + \sum_{k=1}^r \frac{b_{1k}}{(n+\beta_k)} + \frac{b_{2k}}{(n+\beta_k)^2} \\ &\quad + \sum_{k=1}^s \frac{c_{1k}}{(n+\gamma_k)} + \frac{c_{2k}}{(n+\gamma_k)^2} + \frac{c_{3k}}{(n+\gamma_k)^3} \\ \sum_{k=1}^m a_k + \sum_{k=1}^r b_{1k} + \sum_{k=1}^s c_{1k} &= 0. \end{aligned}$$

Then, we may express  $\sum_{n=1}^{\infty} u_n$  in terms of the constants appearing in this partial fraction expansion as follows

$$\begin{aligned} \sum_{n=1}^{\infty} u_n &= -\sum_{j=1}^m a_j \psi(1+\alpha_j) \\ &\quad - \sum_{j=1}^r b_{1j} \psi(1+\beta_j) + \sum_{j=1}^r b_{2j} \psi'(1+\beta_j) \\ &\quad - \sum_{j=1}^s c_{1j} \psi(1+\gamma_j) + \sum_{j=1}^s c_{2j} \psi'(1+\gamma_j) \\ &\quad \quad \quad - \sum_{j=1}^s \frac{c_{3j}}{2!} \psi''(1+\gamma_j). \end{aligned}$$

Higher order repetitions in the denominator are handled similarly. If the denominator contains

only simple or double roots, omit the corresponding lines.

**Example 9.** Find

$$s = \sum_{n=1}^{\infty} \frac{1}{(n+1)(2n+1)(4n+1)}$$

Since

$$\frac{1}{(n+1)(2n+1)(4n+1)} = \frac{\frac{1}{3}}{n+1} - \frac{1}{n+\frac{1}{2}} + \frac{\frac{2}{3}}{n+\frac{1}{4}}$$

we have

$$\alpha_1=1, \alpha_2=\frac{1}{2}, \alpha_3=\frac{1}{4}, a_1=\frac{1}{3}, a_2=-1, a_3=\frac{2}{3}.$$

Thus,

$$s = -\frac{1}{3}\psi(2) + \psi(1\frac{1}{2}) - \frac{2}{3}\psi(1\frac{1}{4}) = .047198.$$

**Example 10.**

Find  $s = \sum_{n=1}^{\infty} \frac{1}{n^2(8n+1)^2}$

Since  $\frac{1}{n^2(8n+1)^2} = -\frac{16}{n} + \frac{16}{n+\frac{1}{8}} + \frac{1}{n^2} + \frac{1}{(n+\frac{1}{8})^2}$

we have,

$$\beta_1=0, \beta_2=\frac{1}{8}, b_{11}=-16, b_{12}=16, b_{21}=1, b_{22}=1.$$

Therefore

$$s = 16\psi(1) - 16\psi(1\frac{1}{8}) + \psi'(1) + \psi'(1\frac{1}{8}) = .013499.$$

**Example 11.**

Evaluate  $s = \sum_{n=1}^{\infty} \frac{1}{(n^2+1)(n^2+4)}$  (see also 6.3.13).

We have,  $\frac{1}{(n^2+1)(n^2+4)} = \frac{i}{6} \left( \frac{1}{n+i} - \frac{1}{n-i} \right) - \frac{i}{12} \left( \frac{1}{n+2i} - \frac{1}{n-2i} \right)$

Hence,  $a_1 = \frac{i}{6}, a_2 = -\frac{i}{6}, a_3 = -\frac{i}{12}, a_4 = \frac{i}{12}$   
 $\alpha_1 = i, \alpha_2 = -i, \alpha_3 = 2i, \alpha_4 = -2i,$

and therefore

$$s = \frac{-i}{6} [\psi(1+i) - \psi(1-i)] + \frac{i}{12} [\psi(1+2i) - \psi(1-2i)].$$

By 6.3.9, this reduces to

$$s = \frac{1}{3} \mathcal{J}\psi(1+i) - \frac{1}{6} \mathcal{J}\psi(1+2i).$$

From Table 6.8,  $s = .13876$ .

### References

**Texts**

[6.1] E. Artin, Einführung in die Theorie der Gammafunktion (Leipzig, Germany, 1931).

[6.2] P. E. Böhmer, Differenzgleichungen und bestimmte Integrale, chs. 3, 4, 5 (K. F. Koehler, Leipzig, Germany, 1939).

[6.3] G. Doetsch, Handbuch der Laplace-Transformation, vol. II, pp. 52-61 (Birkhauser, Basel, Switzerland, 1955).

[6.4] A. Erdélyi et al., Higher transcendental functions, vol. 1, ch. 1, ch. 2, sec. 5; vol. 2, ch. 9 (McGraw-Hill Book Co., Inc., New York, N.Y., 1953).

[6.5] C. Hastings, Jr., Approximations for digital computers (Princeton Univ. Press, Princeton, N.J., 1955).

[6.6] F. Lösch and F. Schoblik, Die Fakultät und verwandte Funktionen (B. G. Teubner, Leipzig, Germany, 1951).

[6.7] W. Sibagaki, Theory and applications of the gamma function (Iwanami Syoten, Tokyo, Japan, 1952).

[6.8] E. T. Whittaker and G. N. Watson, A course of modern analysis, ch. 12, 4th ed. (Cambridge Univ. Press, Cambridge, England, 1952).

**Tables**

[6.9] A. Abramov, Tables of  $\ln \Gamma(z)$  for complex argument. Translated from the Russian by D. G. Fry (Pergamon Press, New York, N.Y., 1960).  $\ln \Gamma(x+iy), x=0(.01)10, y=0(.01)4, 6D$ .

[6.10] Ballistic Research Laboratory, A table of the factorial numbers and their reciprocals from 1! through 1000! to 20 significant digits. Technical Note No. 381, Aberdeen Proving Ground, Md., 1951.

[6.11] British Association for the Advancement of Science, Mathematical tables, vol. 1, 3d ed., pp. 40-59 (Cambridge Univ. Press, Cambridge, England, 1951). The gamma and polygamma functions. Also  $1 + \int_0^x \log_{10}(t)! dt, x=0(.01)1, 10D$ .

[6.12] H. T. Davis, Tables of the higher mathematical functions, 2 vols. (Principia Press, Bloomington, Ind., 1933, 1935). Extensive, many place tables of the gamma and polygamma functions up to  $\psi^{(4)}(x)$  and of their logarithms.

[6.13] F. J. Duarte, Nouvelles tables de  $\log_{10} n!$  à 33 décimales depuis  $n=1$  jusqu'à  $n=3000$  (Kundig, Geneva, Switzerland; Index Generalis, Paris, France, 1927).

- [6.14] National Bureau of Standards, Tables of  $n!$  and  $\Gamma(n+\frac{1}{2})$  for the first thousand values of  $n$ , Applied Math. Series 16 (U.S. Government Printing Office, Washington, D.C., 1951).  $n!$ , 16S;  $\Gamma(n+\frac{1}{2})$ , 8S.
- [6.15] National Bureau of Standards, Table of Coulomb wave functions, vol. I, pp. 114–135, Applied Math. Series 17 (U.S. Government Printing Office, Washington, D.C., 1952).  
 $\mathcal{R}[\Gamma'(1+i\eta)/\Gamma(1+i\eta)]$ ,  $\eta=0(.005)2(.01)6(.02)10(.1)20(.2)60(.5)110, 10D$ ;  $\arg \Gamma(1+i\eta)$ ,  $\eta=0(.01)1(.02)3(.05)10(.2)20(.4)30(.5)85, 8D$ .
- [6.16] National Bureau of Standards, Table of the gamma function for complex arguments, Applied Math. Series 34 (U.S. Government Printing Office, Washington, D.C., 1954).  
 $\ln \Gamma(x+iy)$ ,  $x=0(.1)10$ ,  $y=0(.1)10$ , 12D.  
 Contains an extensive bibliography.
- [6.17] National Physical Laboratory, Tables of Weber parabolic cylinder functions, pp. 226–233 (Her Majesty's Stationery Office, London, England, 1955).  
 Real and imaginary parts of  $\ln \Gamma(\frac{1}{4}k + \frac{1}{2}ia)$ ,  $k=0(1)3$ ,  $a=0(.1)5(.2)20$ , 8D;  $(|\Gamma(\frac{1}{4}k + \frac{1}{2}ia)/\Gamma(\frac{1}{4}k + \frac{1}{2}ia)|)^{-1/2}$   
 $a=0(.02)1(.1)5(.2)20$ , 8D.
- [6.18] E. S. Pearson, Table of the logarithms of the complete  $\Gamma$ -function, arguments 2 to 1200, Tracts for Computers No. VIII (Cambridge Univ. Press, Cambridge, England, 1922).  $\log_{10} \Gamma(p)$ ,  $p=2(.1)5(.2)70(1)1200$ , 10D.
- [6.19] J. Peters, Ten-place logarithm tables, vol. I, Appendix, pp. 58–68 (Frederick Ungar Publ. Co., New York, N.Y., 1957).  $n!$ ,  $n=1(1)60$ , exact;  $(n!)^{-1}$ ,  $n=1(1)43, 54D$ ;  $\log_{10}(n!)$ ,  $n=1(1)1200$ , 18D.
- [6.20] J. P. Stanley and M. V. Wilkes, Table of the reciprocal of the gamma function for complex argument (Univ. of Toronto Press, Toronto, Canada, 1950).  $x=-.5(.01).5$ ,  $y=0(.01)1$ , 6D.
- [6.21] M. Zyczkowski, Tablice funkcji eulera i pokrewnych (Panstwowe Wydawnictwo Naukowe, Warsaw, Poland, 1954). Extensive tables of integrals involving gamma and beta functions.

For references to tabular material on the incomplete gamma and incomplete beta functions, see the references in chapter 26.



# 7. Error Function and Fresnel Integrals

WALTER GAUTSCHI<sup>1</sup>

## Contents

|   | Page |
|---|------|
| <b>Mathematical Properties</b> . . . . .  | 297  |
| 7.1. Error Function . . . . .   | 297  |
| 7.2. Repeated Integrals of the Error Function . . . . .   | 299  |
| 7.3. Fresnel Integrals . . . . .  | 300  |
| 7.4. Definite and Indefinite Integrals . . . . .  | 302  |
| <b>Numerical Methods</b> . . . . .  | 304  |
| 7.5. Use and Extension of the Tables . . . . .  | 304  |
| <b>References</b> . . . . .   | 308  |
| <b>Table 7.1.</b> Error Function and its Derivative ( $0 \leq x \leq 2$ ) . . . . .   | 310  |
| $(2/\sqrt{\pi})e^{-x^2}, \operatorname{erf} x = (2/\sqrt{\pi}) \int_0^x e^{-t^2} dt, x=0(.01)2, 10D$  |      |
| <b>Table 7.2.</b> Derivative of the Error Function ( $2 \leq x \leq 10$ ) . . . . .   | 312  |
| $(2/\sqrt{\pi})e^{-x^2}, x=2(.01)10, 8S$  |      |
| <b>Table 7.3.</b> Complementary Error Function ( $2 \leq x \leq \infty$ ). . . . .  | 316  |
| $xe^{x^2} \operatorname{erfc} x = (2/\sqrt{\pi})xe^{x^2} \int_x^\infty e^{-t^2} dt, x^{-2}=.25(-.005)0, 7D$   |      |
| $\operatorname{erfc} \sqrt{n\pi}, n=1(1)10, 15D$  |      |
| <b>Table 7.4.</b> Repeated Integrals of the Error Function ( $0 \leq x \leq 5$ ) . . . . .  | 317  |
| $2^n \Gamma\left(\frac{n}{2}+1\right) i^n \operatorname{erfc} x = 2^{n+1} \Gamma\left(\frac{n}{2}+1\right) \frac{1}{\sqrt{\pi}} \int_x^\infty \frac{(t-x)^n}{n!} e^{-t^2} dt$ |      |
| $x=0(.1)5, n=1(1)6, 10, 11, 6S$   |      |
| <b>Table 7.5.</b> Dawson's Integral ( $0 \leq x \leq \infty$ ) . . . . .  | 319  |
| $e^{-x^2} \int_0^x e^{t^2} dt, x=0(.02)2, 10D$  |      |
| $xe^{-x^2} \int_0^x e^{t^2} dt, x^{-2}=.25(-.005)0, 9D$   |      |

<sup>1</sup> Guest worker, National Bureau of Standards, from The American University. (Presently Purdue University.)

# 7. Error Function and Fresnel Integrals

## Mathematical Properties

### 7.1. Error Function

#### Definitions

$$7.1.1 \quad \operatorname{erf} z = \frac{2}{\sqrt{\pi}} \int_0^z e^{-t^2} dt$$

$$7.1.2 \quad \operatorname{erfc} z = \frac{2}{\sqrt{\pi}} \int_z^\infty e^{-t^2} dt = 1 - \operatorname{erf} z$$

$$7.1.3 \quad w(z) = e^{-z^2} \left( 1 + \frac{2i}{\sqrt{\pi}} \int_0^z e^{t^2} dt \right) = e^{-z^2} \operatorname{erfc}(-iz)$$

In 7.1.2 the path of integration is subject to the restriction  $\arg t \rightarrow \alpha$  with  $|\alpha| < \frac{\pi}{4}$  as  $t \rightarrow \infty$  along the path. ( $\alpha = \frac{\pi}{4}$  is permissible if  $\Re t^2$  remains bounded to the left.)

#### Integral Representation

$$7.1.4 \quad w(z) = \frac{i}{\pi} \int_{-\infty}^{\infty} \frac{e^{-t^2} dt}{z-t} = \frac{2iz}{\pi} \int_0^{\infty} \frac{e^{-t^2} dt}{z^2 - t^2} \quad (\Im z > 0)$$

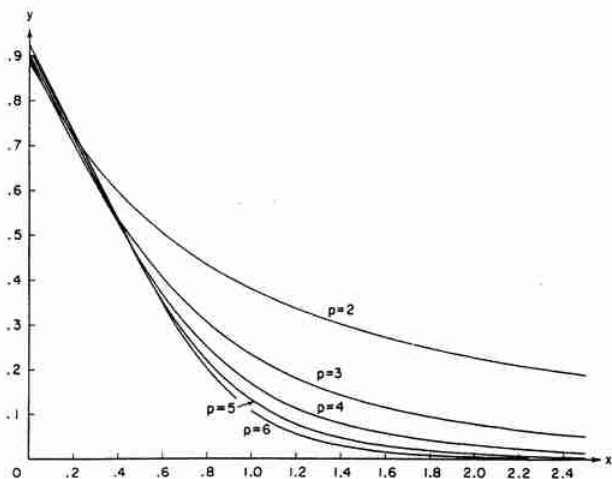

FIGURE 7.1.  $y = e^{-z^2} \int_x^\infty e^{-t^2} dt$ .  
p=2(1)6

#### Series Expansions

$$7.1.5 \quad \operatorname{erf} z = \frac{2}{\sqrt{\pi}} \sum_{n=0}^{\infty} \frac{(-1)^n z^{2n+1}}{n!(2n+1)}$$

$$7.1.6 \quad = \frac{2}{\sqrt{\pi}} e^{-z^2} \sum_{n=0}^{\infty} \frac{2^n}{1 \cdot 3 \dots (2n+1)} z^{2n+1}$$

$$7.1.7 \quad = \sqrt{2} \sum_{n=0}^{\infty} (-1)^n [I_{2n+1/2}(z^2) - I_{2n+3/2}(z^2)]$$

$$7.1.8 \quad w(z) = \sum_{n=0}^{\infty} \frac{(iz)^n}{\Gamma\left(\frac{n}{2} + 1\right)}$$

For  $I_{n-1}(x)$ , see chapter 10.

#### Symmetry Relations

$$7.1.9 \quad \operatorname{erf}(-z) = -\operatorname{erf} z$$

$$7.1.10 \quad \operatorname{erf} \bar{z} = \overline{\operatorname{erf} z}$$

$$7.1.11 \quad w(-z) = 2e^{-z^2} - w(z)$$

$$7.1.12 \quad w(\bar{z}) = \overline{w(-z)}$$

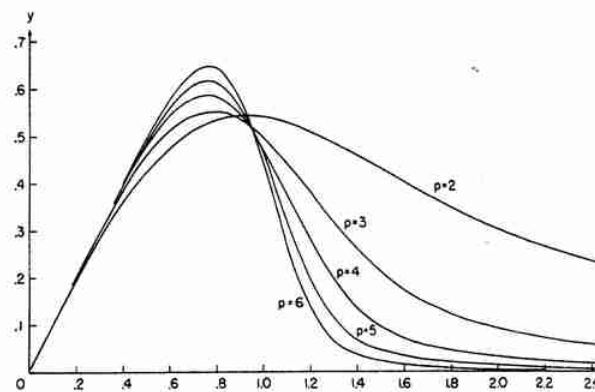

FIGURE 7.2.  $y = e^{-z^2} \int_0^x e^{t^2} dt$ .  
p=2(1)6



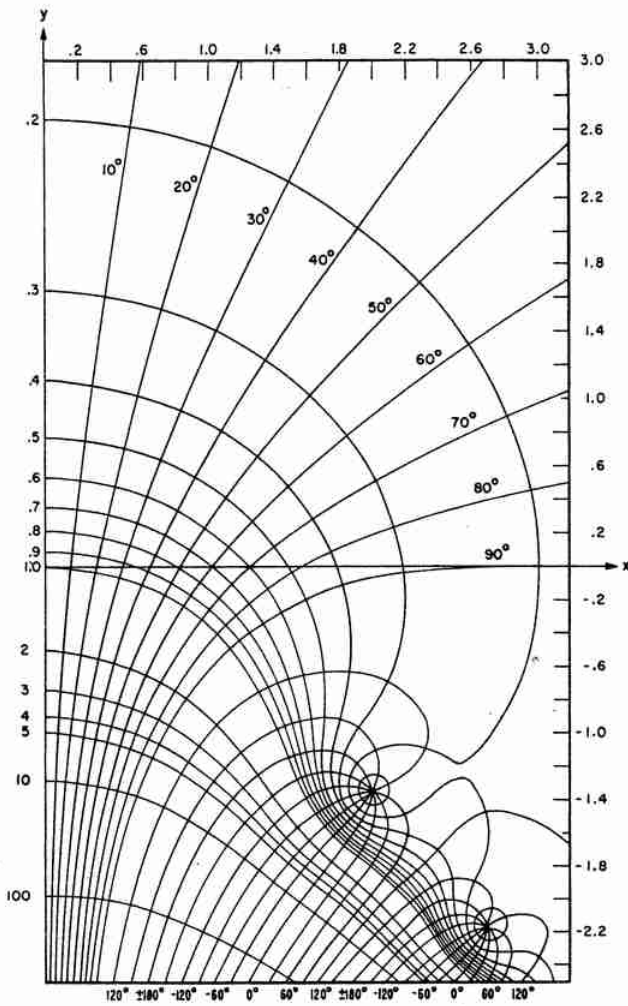

FIGURE 7.3. Altitude Chart of  $w(z)$ .

**Inequalities [7.11], [7.17]**

7.1.13

$$\frac{1}{x + \sqrt{x^2 + 2}} < e^{z^2} \int_x^\infty e^{-t^2} dt \leq \frac{1}{x + \sqrt{x^2 + \frac{4}{\pi}}} \quad (x \geq 0)$$

(For other inequalities see [7.2].)

**Continued Fractions**

7.1.14

$$2e^{z^2} \int_z^\infty e^{-t^2} dt = \frac{1}{z + \frac{1/2}{z + \frac{1}{z + \frac{3/2}{z + \frac{2}{z + \dots}}}}} \quad (\Re z > 0)$$

7.1.15

$$\frac{1}{\sqrt{\pi}} \int_{-\infty}^\infty \frac{e^{-t^2} dt}{z-t} = \frac{1}{z} - \frac{1/2}{z} - \frac{1}{z} - \frac{3/2}{z} - \frac{2}{z} - \dots$$

$$= \frac{1}{\sqrt{\pi}} \lim_{n \rightarrow \infty} \sum_{k=1}^n \frac{H_k^{(n)}}{z - x_k^{(n)}} \quad (\Im z \neq 0)$$

$x_k^{(n)}$  and  $H_k^{(n)}$  are the zeros and weight factors of the Hermite polynomials. For numerical values see chapter 25.

**Value at Infinity**

7.1.16  $\operatorname{erf} z \rightarrow 1$  ( $z \rightarrow \infty$  in  $|\arg z| < \frac{\pi}{4}$ )

**Maximum and Inflection Points for Dawson's Integral [7.31]**

$$F(x) = e^{-x^2} \int_0^x e^{t^2} dt$$

7.1.17  $F(.92413 88730 \dots) = .54104 42246 \dots$

7.1.18  $F(1.50197 52682 \dots) = .42768 66160 \dots$

**Derivatives**

7.1.19

$$\frac{d^{n+1}}{dz^{n+1}} \operatorname{erf} z = (-1)^n \frac{2}{\sqrt{\pi}} H_n(z) e^{-z^2} \quad (n=0, 1, 2, \dots)$$

7.1.20

$$w^{(n+2)}(z) + 2zw^{(n+1)}(z) + 2(n+1)w^{(n)}(z) = 0 \quad (n=0, 1, 2, \dots)$$

$$w^{(0)}(z) = w(z), \quad w'(z) = -2zw(z) + \frac{2i}{\sqrt{\pi}}$$

(For the Hermite polynomials  $H_n(z)$  see chapter 22.)

**Relation to Confluent Hypergeometric Function (see chapter 13)**

7.1.21

$$\operatorname{erf} z = \frac{2z}{\sqrt{\pi}} M\left(\frac{1}{2}, \frac{3}{2}, -z^2\right) = \frac{2z}{\sqrt{\pi}} e^{-z^2} M\left(1, \frac{3}{2}, z^2\right)$$

**The Normal Distribution Function With Mean  $m$  and Standard Deviation  $\sigma$  (see chapter 26)**

$$7.1.22 \quad \frac{1}{\sigma\sqrt{2\pi}} \int_{-\infty}^x e^{-\frac{(t-m)^2}{2\sigma^2}} dt = \frac{1}{2} \left( 1 + \operatorname{erf} \left( \frac{x-m}{\sigma\sqrt{2}} \right) \right)$$

**Asymptotic Expansion**

7.1.23

$$\sqrt{\pi} z e^{z^2} \operatorname{erfc} z \sim 1 + \sum_{m=1}^\infty (-1)^m \frac{1 \cdot 3 \dots (2m-1)}{(2z^2)^m}$$

$$(z \rightarrow \infty, |\arg z| < \frac{3\pi}{4})$$

If  $R_n(z)$  is the remainder after  $n$  terms then

7.1.24

$$R_n(z) = (-1)^n \frac{1 \cdot 3 \dots (2n-1)}{(2z^2)^n} \theta,$$

$$\theta = \int_0^\infty e^{-t} \left(1 + \frac{t}{z^2}\right)^{-n-\frac{1}{2}} dt \quad \left(|\arg z| < \frac{\pi}{2}\right)$$

$$|\theta| < 1 \quad \left(|\arg z| < \frac{\pi}{4}\right)$$

For  $x$  real,  $R_n(x)$  is less in absolute value than the first neglected term and of the same sign.

Rational Approximations<sup>2</sup> ( $0 \leq x < \infty$ )

7.1.25

$$\operatorname{erf} x = 1 - (a_1 t + a_2 t^2 + a_3 t^3) e^{-x^2} + \epsilon(x), \quad t = \frac{1}{1+px}$$

$$|\epsilon(x)| \leq 2.5 \times 10^{-5}$$

$$p = .47047 \quad a_1 = .34802 \ 42 \quad a_2 = -.09587 \ 98$$

$$a_3 = .74785 \ 56$$

7.1.26

$$\operatorname{erf} x = 1 - (a_1 t + a_2 t^2 + a_3 t^3 + a_4 t^4 + a_5 t^5) e^{-x^2} + \epsilon(x),$$

$$t = \frac{1}{1+px}$$

$$|\epsilon(x)| \leq 1.5 \times 10^{-7}$$

$$p = .32759 \ 11 \quad a_1 = .25482 \ 9592$$

$$a_2 = -.28449 \ 6736 \quad a_3 = 1.42141 \ 3741$$

$$a_4 = -1.45315 \ 2027 \quad a_5 = 1.06140 \ 5429$$

7.1.27

$$\operatorname{erf} x = 1 - \frac{1}{[1 + a_1 x + a_2 x^2 + a_3 x^3 + a_4 x^4]^4} + \epsilon(x)$$

$$|\epsilon(x)| \leq 5 \times 10^{-4}$$

$$a_1 = .278393 \quad a_2 = .230389$$

$$a_3 = .000972 \quad a_4 = .078108$$

7.1.28

$$\operatorname{erf} x = 1 - \frac{1}{[1 + a_1 x + a_2 x^2 + \dots + a_6 x^6]^{16}} + \epsilon(x)$$

$$|\epsilon(x)| \leq 3 \times 10^{-7}$$

$$a_1 = .07052 \ 30784 \quad a_2 = .04228 \ 20123$$

$$a_3 = .00927 \ 05272 \quad a_4 = .00015 \ 20143$$

$$a_5 = .00027 \ 65672 \quad a_6 = .00004 \ 30638$$

<sup>2</sup> Approximations 7.1.25-7.1.28 are from C. Hastings, Jr., Approximations for digital computers. Princeton Univ. Press, Princeton, N. J., 1955 (with permission).

Infinite Series Approximation for Complex Error Function [7.19]

7.1.29

$$\operatorname{erf}(x+iy) = \operatorname{erf} x + \frac{e^{-x^2}}{2\pi x} [(1 - \cos 2xy) + i \sin 2xy]$$

$$+ \frac{2}{\pi} e^{-x^2} \sum_{n=1}^{\infty} \frac{e^{-4n^2}}{n^2 + 4x^2} [f_n(x, y) + i g_n(x, y)] + \epsilon(x, y)$$

where

$$f_n(x, y) = 2x - 2x \cosh ny \cos 2xy + n \sinh ny \sin 2xy$$

$$g_n(x, y) = 2x \cosh ny \sin 2xy + n \sinh ny \cos 2xy$$

$$|\epsilon(x, y)| \approx 10^{-16} |\operatorname{erf}(x+iy)|$$

7.2. Repeated Integrals of the Error Function

Definition

7.2.1

$$i^n \operatorname{erfc} z = \int_z^\infty i^{n-1} \operatorname{erfc} t \, dt \quad (n=0, 1, 2, \dots)$$

$$i^{-1} \operatorname{erfc} z = \frac{2}{\sqrt{\pi}} e^{-z^2}, \quad i^0 \operatorname{erfc} z = \operatorname{erfc} z$$

Differential Equation

7.2.2

$$\frac{d^2 y}{dz^2} + 2z \frac{dy}{dz} - 2ny = 0$$

$$y = Ai^n \operatorname{erfc} z + Bi^n \operatorname{erfc}(-z)$$

( $A$  and  $B$  are constants.)

Expression as a Single Integral

$$7.2.3 \quad i^n \operatorname{erfc} z = \frac{2}{\sqrt{\pi}} \int_z^\infty \frac{(t-z)^n}{n!} e^{-t^2} dt$$

Power Series<sup>3</sup>

$$7.2.4 \quad i^n \operatorname{erfc} z = \sum_{k=0}^{\infty} \frac{(-1)^k z^k}{2^{n-k} k! \Gamma\left(1 + \frac{n-k}{2}\right)}$$

Recurrence Relations

7.2.5

$$i^n \operatorname{erfc} z = -\frac{z}{n} i^{n-1} \operatorname{erfc} z + \frac{1}{2n} i^{n-2} \operatorname{erfc} z$$

$$(n=1, 2, 3, \dots)$$

7.2.6

$$2(n+1)(n+2)i^{n+2} \operatorname{erfc} z$$

$$= (2n+1+2z^2)i^n \operatorname{erfc} z - \frac{1}{2} i^{n-2} \operatorname{erfc} z$$

$$(n=1, 2, 3, \dots)$$

<sup>3</sup> The terms in this series corresponding to  $k=n+2, n+4, n+6, \dots$  are understood to be zero.

## Value at Zero

## 7.2.7

$$i^n \operatorname{erfc} 0 = \frac{1}{2^n \Gamma\left(\frac{n}{2} + 1\right)} \quad (n = -1, 0, 1, 2, \dots)$$

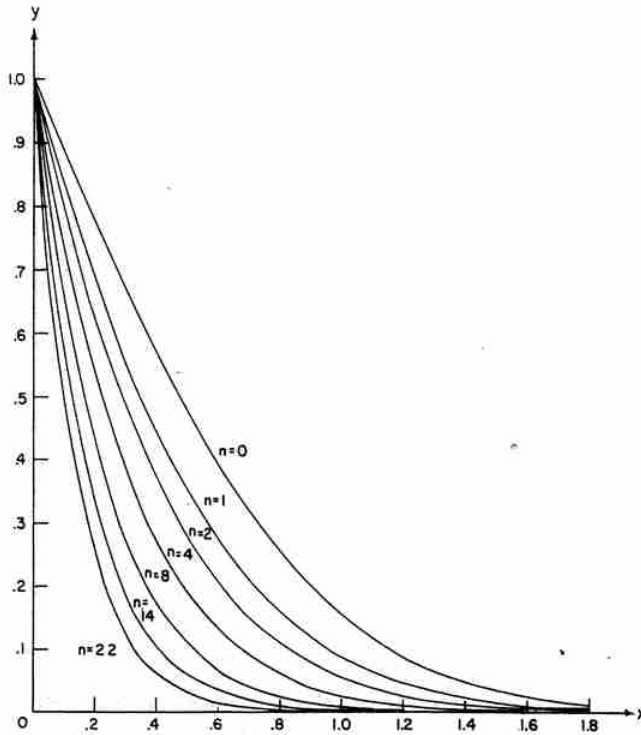

FIGURE 7.4. Repeated Integrals of the Error Function.

$$y = 2^n \Gamma\left(\frac{n}{2} + 1\right) i^n \operatorname{erfc} z$$

$$n = 0, 1, 2, 4, 8, 14, 22$$

## Derivatives

$$7.2.8 \quad \frac{d}{dz} i^n \operatorname{erfc} z = -i^{n-1} \operatorname{erfc} z \quad (n = 0, 1, 2, \dots)$$

## 7.2.9

$$\frac{d^n}{dz^n} (e^{z^2} \operatorname{erfc} z) = (-1)^n 2^n n! e^{z^2} i^n \operatorname{erfc} z$$

$$(n = 0, 1, 2, \dots)$$

Relation to  $Hh_n(x)$  (see 19.14)

$$7.2.10 \quad i^n \operatorname{erfc} z = \frac{1}{(2^{n-1} \pi)^{\frac{1}{2}}} Hh_n(\sqrt{2}z)$$

## Relation to Hermite Polynomials (see chapter 22)

$$7.2.11 \quad (-1)^n i^n \operatorname{erfc} z + i^n \operatorname{erfc} (-z) = \frac{i^{-n}}{2^{n-1} n!} H_n(iz)$$

Relation to the Confluent Hypergeometric Function  
(see chapter 13)

## 7.2.12

$$i^n \operatorname{erfc} z = e^{-z^2} \left[ \frac{1}{2^n \Gamma\left(\frac{n}{2} + 1\right)} M\left(\frac{n+1}{2}, \frac{1}{2}, z^2\right) - \frac{z}{2^{n-1} \Gamma\left(\frac{n+1}{2}\right)} M\left(\frac{n}{2} + 1, \frac{3}{2}, z^2\right) \right]$$

Relation to Parabolic Cylinder Functions (see  
chapter 19)

$$7.2.13 \quad i^n \operatorname{erfc} z = \frac{e^{-\frac{1}{2}z^2}}{(2^{n-1} \pi)^{\frac{1}{2}}} D_{-n-1}(z\sqrt{2})$$

## Asymptotic Expansion

## 7.2.14

$$i^n \operatorname{erfc} z \sim \frac{2}{\sqrt{\pi}} \frac{e^{-z^2}}{(2z)^{n+1}} \sum_{m=0}^{\infty} \frac{(-1)^m (2m+n)!}{n! m! (2z)^{2m}}$$

$$(z \rightarrow \infty, |\arg z| < \frac{3\pi}{4})$$

## 7.3. Fresnel Integrals

## Definition

$$7.3.1 \quad C(z) = \int_0^z \cos\left(\frac{\pi}{2} t^2\right) dt$$

$$7.3.2 \quad S(z) = \int_0^z \sin\left(\frac{\pi}{2} t^2\right) dt$$

The following functions are also in use:

## 7.3.3

$$C_1(x) = \sqrt{\frac{2}{\pi}} \int_0^x \cos t^2 dt, \quad C_2(x) = \frac{1}{\sqrt{2\pi}} \int_0^x \frac{\cos t}{\sqrt{t}} dt$$

## 7.3.4

$$S_1(x) = \sqrt{\frac{2}{\pi}} \int_0^x \sin t^2 dt, \quad S_2(x) = \frac{1}{\sqrt{2\pi}} \int_0^x \frac{\sin t}{\sqrt{t}} dt$$

## Auxiliary Functions

## 7.3.5

$$f(z) = \left[\frac{1}{2} - S(z)\right] \cos\left(\frac{\pi}{2} z^2\right) - \left[\frac{1}{2} - C(z)\right] \sin\left(\frac{\pi}{2} z^2\right)$$

## 7.3.6

$$g(z) = \left[\frac{1}{2} - C(z)\right] \cos\left(\frac{\pi}{2} z^2\right) + \left[\frac{1}{2} - S(z)\right] \sin\left(\frac{\pi}{2} z^2\right)$$

## Interrelations

$$7.3.7 \quad C(x) = C_1\left(x\sqrt{\frac{\pi}{2}}\right) = C_2\left(\frac{\pi}{2} x^2\right)$$

7.3.8  $S(x) = S_1\left(x\sqrt{\frac{\pi}{2}}\right) = S_2\left(\frac{\pi}{2}x^2\right)$

7.3.9  $C(z) = \frac{1}{2} + f(z) \sin\left(\frac{\pi}{2}z^2\right) - g(z) \cos\left(\frac{\pi}{2}z^2\right)$

7.3.10  $S(z) = \frac{1}{2} - f(z) \cos\left(\frac{\pi}{2}z^2\right) - g(z) \sin\left(\frac{\pi}{2}z^2\right)$

Series Expansions

7.3.11  $C(z) = \sum_{n=0}^{\infty} \frac{(-1)^n (\pi/2)^{2n}}{(2n)!(4n+1)} z^{4n+1}$

7.3.12 
$$C(z) = \cos\left(\frac{\pi}{2}z^2\right) \sum_{n=0}^{\infty} \frac{(-1)^n \pi^{2n}}{1 \cdot 3 \dots (4n+1)} z^{4n+1}$$

$$+ \sin\left(\frac{\pi}{2}z^2\right) \sum_{n=0}^{\infty} \frac{(-1)^n \pi^{2n+1}}{1 \cdot 3 \dots (4n+3)} z^{4n+3}$$

7.3.13  $S(z) = \sum_{n=0}^{\infty} \frac{(-1)^n (\pi/2)^{2n+1}}{(2n+1)!(4n+3)} z^{4n+3}$

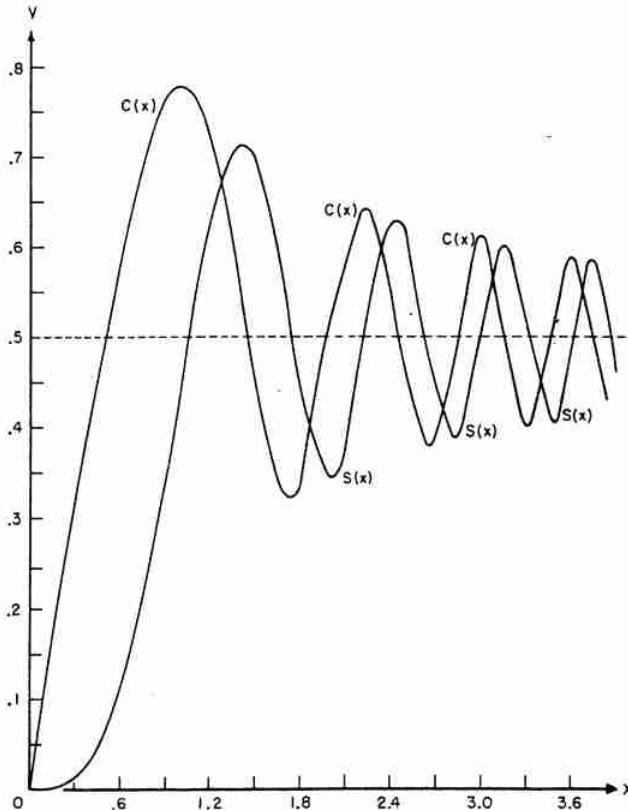

FIGURE 7.5. Fresnel Integrals.  
y=C(x), y=S(x)

7.3.14

$$S(z) = -\cos\left(\frac{\pi}{2}z^2\right) \sum_{n=0}^{\infty} \frac{(-1)^n \pi^{2n+1}}{1 \cdot 3 \dots (4n+3)} z^{4n+3}$$

$$+ \sin\left(\frac{\pi}{2}z^2\right) \sum_{n=0}^{\infty} \frac{(-1)^n \pi^{2n}}{1 \cdot 3 \dots (4n+1)} z^{4n+1}$$

7.3.15  $C_2(z) = J_{1/2}(z) + J_{5/2}(z) + J_{9/2}(z) + \dots$

7.3.16  $S_2(z) = J_{3/2}(z) + J_{7/2}(z) + J_{11/2}(z) + \dots$

For Bessel functions  $J_{n+1/2}(z)$  see chapter 10.

Symmetry Relations

7.3.17  $C(-z) = -C(z), S(-z) = -S(z)$

7.3.18  $C(iz) = iC(z), S(iz) = -iS(z)$

7.3.19  $C(\bar{z}) = \overline{C(z)}, S(\bar{z}) = \overline{S(z)}$

Value at Infinity

7.3.20  $C(x) \rightarrow \frac{1}{2}, S(x) \rightarrow \frac{1}{2} \quad (x \rightarrow \infty)$

Derivatives

7.3.21  $\frac{dC(x)}{dx} = -\pi x g(x), \quad \frac{dS(x)}{dx} = \pi x f(x) - 1$

Relation to Error Function (see 7.1.1, 7.1.3)

7.3.22

$$C(z) + iS(z) = \frac{1+i}{2} \operatorname{erf}\left[\frac{\sqrt{\pi}}{2}(1-i)z\right]$$

$$= \frac{1+i}{2} \left\{ 1 - e^{i\frac{\pi}{2}z^2} w\left[\frac{\sqrt{\pi}}{2}(1+i)z\right] \right\}$$

7.3.23  $g(x) = \mathcal{R} \left\{ \frac{1+i}{2} w\left[\frac{\sqrt{\pi}}{2}(1+i)x\right] \right\}$

7.3.24  $f(x) = \mathcal{I} \left\{ \frac{1+i}{2} w\left[\frac{\sqrt{\pi}}{2}(1+i)x\right] \right\}$

Relation to Confluent Hypergeometric Function (see chapter 13)

7.3.25

$$C(z) + iS(z) = zM\left(\frac{1}{2}, \frac{3}{2}, i\frac{\pi}{2}z^2\right)$$

$$= ze^{i\frac{\pi}{2}z^2} M\left(1, \frac{3}{2}, -i\frac{\pi}{2}z^2\right)$$

Relation to Spherical Bessel Functions (see chapter 10)

7.3.26  $C_2(z) = \frac{1}{2} \int_0^z J_{-1/2}(t) dt, S_2(z) = \frac{1}{2} \int_0^z J_{1/2}(t) dt$

## Asymptotic Expansions

## 7.3.27

$$\pi z f(z) \sim 1 + \sum_{m=1}^{\infty} (-1)^m \frac{1 \cdot 3 \dots (4m-1)}{(\pi z^2)^{2m}} \quad \left( z \rightarrow \infty, |\arg z| < \frac{\pi}{2} \right)$$

## 7.3.28

$$\pi z g(z) \sim \sum_{m=0}^{\infty} (-1)^m \frac{1 \cdot 3 \dots (4m+1)}{(\pi z^2)^{2m+1}} \quad \left( z \rightarrow \infty, |\arg z| < \frac{\pi}{2} \right)$$

If  $R_n^{(f)}(z)$ ,  $R_n^{(g)}(z)$  are the remainders after  $n$  terms in 7.3.27, 7.3.28, respectively, then

## 7.3.29

$$R_n^{(f)}(z) = (-1)^n \frac{1 \cdot 3 \dots (4n-1)}{(\pi z^2)^{2n}} \theta^{(f)},$$

$$\theta^{(f)} = \frac{1}{\Gamma(2n + \frac{1}{2})} \int_0^{\infty} \frac{e^{-t} t^{2n-1}}{1 + \left(\frac{2t}{\pi z^2}\right)^2} dt \quad \left( |\arg z| < \frac{\pi}{4} \right)$$

## 7.3.30

$$R_n^{(g)}(z) = (-1)^n \frac{1 \cdot 3 \dots (4n+1)}{(\pi z^2)^{2n}} \theta^{(g)},$$

$$\theta^{(g)} = \frac{1}{\Gamma(2n + \frac{3}{2})} \int_0^{\infty} \frac{e^{-t} t^{2n+1}}{1 + \left(\frac{2t}{\pi z^2}\right)^2} dt \quad \left( |\arg z| < \frac{\pi}{4} \right)$$

$$7.3.31 \quad |\theta^{(f)}| < 1, |\theta^{(g)}| < 1 \quad \left( |\arg z| \leq \frac{\pi}{8} \right)$$

For  $x$  real,  $R_n^{(f)}(x)$  and  $R_n^{(g)}(x)$  are less in absolute value than the first neglected term and of the same sign.

Rational Approximations<sup>4</sup> ( $0 \leq x \leq \infty$ )

## 7.3.32

$$f(x) = \frac{1 + .926x}{2 + 1.792x + 3.104x^2} + \epsilon(x) \quad |\epsilon(x)| \leq 2 \times 10^{-3}$$

## 7.3.33

$$g(x) = \frac{1}{2 + 4.142x + 3.492x^2 + 6.670x^3} + \epsilon(x) \quad |\epsilon(x)| \leq 2 \times 10^{-3}$$

(For more accurate approximations see [7.1].)

## 7.4. Definite and Indefinite Integrals

For a more extensive list of integrals see [7.5], [7.8], [7.15].

$$7.4.1 \quad \int_0^{\infty} e^{-t^2} dt = \frac{\sqrt{\pi}}{2}$$

<sup>4</sup> Approximations 7.3.32, 7.3.33 are based on those given in C. Hastings, Jr., Approximations for calculating Fresnel integrals, Approximation Newsletter, April 1956, Note 10. [See also MTAC 10, 173, 1956.]

## 7.4.2

$$\int_0^{\infty} e^{-(at^2+2bt+c)} dt = \frac{1}{2} \sqrt{\frac{\pi}{a}} e^{\frac{b^2-ac}{a}} \operatorname{erfc} \frac{b}{\sqrt{a}} \quad (\Re a > 0)$$

## 7.4.3

$$\int_0^{\infty} e^{-at^2 - \frac{b}{t^2}} dt = \frac{1}{2} \sqrt{\frac{\pi}{a}} e^{-2\sqrt{ab}} \quad (\Re a > 0, \Re b > 0)$$

## 7.4.4

$$\int_0^{\infty} t^{2n} e^{-at^2} dt = \frac{1 \cdot 3 \dots (2n-1)}{2^{n+1} a^n} \sqrt{\frac{\pi}{a}}$$

$$= \frac{\Gamma(n + \frac{1}{2})}{2a^{n+\frac{1}{2}}} \quad (\Re a > 0; n = 0, 1, 2, \dots)$$

## 7.4.5

$$\int_0^{\infty} t^{2n+1} e^{-at^2} dt = \frac{n!}{2a^{n+1}} \quad (\Re a > 0; n = 0, 1, 2, \dots)$$

## 7.4.6

$$\int_0^{\infty} e^{-at^2} \cos(2xt) dt = \frac{1}{2} \sqrt{\frac{\pi}{a}} e^{-\frac{x^2}{a}} \quad (\Re a > 0)$$

## 7.4.7

$$\int_0^{\infty} e^{-at^2} \sin(2xt) dt = \frac{1}{\sqrt{a}} e^{-x^2/a} \int_0^{x/\sqrt{a}} e^{-t^2} dt \quad (\Re a > 0)$$

## 7.4.8

$$\int_0^{\infty} \frac{e^{-at} dt}{\sqrt{t+z^2}} = \sqrt{\frac{\pi}{a}} e^{az^2} \operatorname{erfc} \sqrt{az} \quad (\Re a > 0, \Re z > 0)$$

## 7.4.9

$$\int_0^{\infty} \frac{e^{-at} dt}{\sqrt{t(t+z)}} = \frac{\pi}{\sqrt{z}} e^{az} \operatorname{erfc} \sqrt{az}$$

$$(\Re a > 0, z \neq 0, |\arg z| < \pi)$$

## 7.4.10

$$\int_0^{\infty} \frac{e^{-at^2} dt}{t+x} = e^{-ax^2} \left[ \sqrt{\pi} \int_0^{\sqrt{ax}} e^{-t^2} dt - \frac{1}{2} \operatorname{Ei}(ax^2) \right] \quad *$$

$$(a > 0, x > 0)$$

## 7.4.11

$$\int_0^{\infty} \frac{e^{-at^2} dt}{t^2+x^2} = \frac{\pi}{2x} e^{ax^2} \operatorname{erfc} \sqrt{ax} \quad (a > 0, x > 0)$$

$$7.4.12 \quad \int_0^1 \frac{e^{-at^2} dt}{t^2+1} = \frac{\pi}{4} e^a [1 - (\operatorname{erf} \sqrt{a})^2] \quad (a > 0)$$

## 7.4.13

$$\int_{-\infty}^{\infty} \frac{ye^{-t^2} dt}{(x-t)^2+y^2} = \pi \operatorname{Re} w(x+iy) \quad (x \text{ real}, y > 0)$$

\*See page II.

7.4.14

$$\int_{-\infty}^{\infty} \frac{(x-t)e^{-t^2} dt}{(x-t)^2+y^2} = \pi \mathcal{I} w(x+iy) \quad (x \text{ real}, y > 0)$$

7.4.15

$$\int_0^{\infty} \frac{[t^2-(x^2-y^2)]e^{-t^2} dt}{t^4-2(x^2-y^2)t^2+(x^2+y^2)^2} = \frac{\pi}{2} \mathcal{R} \frac{w(x+iy)}{y-ix} \quad (x \text{ real}, y > 0)$$

7.4.16

$$\int_0^{\infty} \frac{2xye^{-t^2} dt}{t^4-2(x^2-y^2)t^2+(x^2+y^2)^2} = \frac{\pi}{2} \mathcal{I} \frac{w(x+iy)}{y-ix} \quad (x \text{ real}, y > 0)$$

7.4.17

$$\int_0^{\infty} e^{-at} \operatorname{erf} bt \, dt = \frac{1}{a} e^{\frac{a^2}{4b^2}} \operatorname{erfc} \frac{a}{2b} \quad (\mathcal{R} a > 0, |\arg b| < \frac{\pi}{4})$$

7.4.18

$$\int_0^{\infty} \sin(2at) \operatorname{erfc} bt \, dt = \frac{1}{2a} [1 - e^{-(a/b)^2}] \quad (a > 0, \mathcal{R} b > 0)$$

7.4.19

$$\int_0^{\infty} e^{-at} \operatorname{erf} \sqrt{bt} \, dt = \frac{1}{a} \sqrt{\frac{b}{a+b}} \quad (\mathcal{R}(a+b) > 0)$$

7.4.20

$$\int_0^{\infty} e^{-at} \operatorname{erfc} \sqrt{\frac{b}{t}} \, dt = \frac{1}{a} e^{-2\sqrt{ab}} \quad (\mathcal{R} a > 0, \mathcal{R} b > 0)$$

7.4.21

$$\int_0^{\infty} e^{(a-b)t} \operatorname{erfc}(\sqrt{at} + \sqrt{\frac{c}{t}}) \, dt = \frac{e^{-2(\sqrt{ac} + \sqrt{bc})}}{\sqrt{b}(\sqrt{a} + \sqrt{b})} \quad (\mathcal{R} b > 0, \mathcal{R} c > 0)$$

7.4.22

$$\int_0^{\infty} e^{-at} \cos(t^2) \, dt = \sqrt{\frac{\pi}{2}} \left\{ \left[ \frac{1}{2} - S\left(\frac{a}{2}\sqrt{\frac{2}{\pi}}\right) \right] \cos\left(\frac{a^2}{4}\right) - \left[ \frac{1}{2} - C\left(\frac{a}{2}\sqrt{\frac{2}{\pi}}\right) \right] \sin\left(\frac{a^2}{4}\right) \right\} \quad (\mathcal{R} a > 0)$$

7.4.23

$$\int_0^{\infty} e^{-at} \sin(t^2) \, dt = \sqrt{\frac{\pi}{2}} \left\{ \left[ \frac{1}{2} - C\left(\frac{a}{2}\sqrt{\frac{2}{\pi}}\right) \right] \cos\left(\frac{a^2}{4}\right) + \left[ \frac{1}{2} - S\left(\frac{a}{2}\sqrt{\frac{2}{\pi}}\right) \right] \sin\left(\frac{a^2}{4}\right) \right\} \quad (\mathcal{R} a > 0)$$

7.4.24

$$\int_0^{\infty} e^{-at} \frac{\sin(t^2)}{t} \, dt = \frac{\pi}{2} \left[ \frac{1}{2} - C\left(\frac{a}{2}\sqrt{\frac{2}{\pi}}\right) \right]^2 + \frac{\pi}{2} \left[ \frac{1}{2} - S\left(\frac{a}{2}\sqrt{\frac{2}{\pi}}\right) \right]^2 \quad (\mathcal{R} a > 0)$$

7.4.25

$$\int_0^{\infty} \frac{e^{-at}\sqrt{t}}{t^2+b^2} \, dt = \pi \sqrt{\frac{2}{b}} \left\{ \left[ \frac{1}{2} - C\left(\sqrt{\frac{2ab}{\pi}}\right) \right] \cos(ab) + \left[ \frac{1}{2} - S\left(\sqrt{\frac{2ab}{\pi}}\right) \right] \sin(ab) \right\} \quad (\mathcal{R} a > 0, \mathcal{R} b > 0)$$

7.4.26

$$\int_0^{\infty} \frac{e^{-at}}{\sqrt{t}(t^2+b^2)} \, dt = \frac{\pi}{b} \sqrt{\frac{2}{b}} \left\{ \left[ \frac{1}{2} - S\left(\sqrt{\frac{2ab}{\pi}}\right) \right] \cos(ab) - \left[ \frac{1}{2} - C\left(\sqrt{\frac{2ab}{\pi}}\right) \right] \sin(ab) \right\} \quad (\mathcal{R} a > 0, \mathcal{R} b > 0)$$

7.4.27

$$\int_0^{\infty} e^{-at} C(t) \, dt = \frac{1}{a} \left\{ \left[ \frac{1}{2} - S\left(\frac{a}{\pi}\right) \right] \cos\left(\frac{a^2}{2\pi}\right) - \left[ \frac{1}{2} - C\left(\frac{a}{\pi}\right) \right] \sin\left(\frac{a^2}{2\pi}\right) \right\} \quad (\mathcal{R} a > 0)$$

7.4.28

$$\int_0^{\infty} e^{-at} S(t) \, dt = \frac{1}{a} \left\{ \left[ \frac{1}{2} - C\left(\frac{a}{\pi}\right) \right] \cos\left(\frac{a^2}{2\pi}\right) + \left[ \frac{1}{2} - S\left(\frac{a}{\pi}\right) \right] \sin\left(\frac{a^2}{2\pi}\right) \right\} \quad (\mathcal{R} a > 0)$$

7.4.29

$$\int_0^{\infty} e^{-at} C\left(\sqrt{\frac{2t}{\pi}}\right) \, dt = \frac{1}{2a(\sqrt{a^2+1}-a)\sqrt{a^2+1}} \quad (\mathcal{R} a > 0)$$

7.4.30

$$\int_0^{\infty} e^{-at} S\left(\sqrt{\frac{2t}{\pi}}\right) \, dt = \frac{1}{2a(\sqrt{a^2+1}+a)\sqrt{a^2+1}} \quad (\mathcal{R} a > 0)$$

$$7.4.31 \quad \int_0^{\infty} \left\{ \left[ \frac{1}{2} - C(t) \right]^2 + \left[ \frac{1}{2} - S(t) \right]^2 \right\} dt = \frac{1}{\pi}$$

7.4.32

$$\int e^{-(ax^2+2bx+c)} \, dx = \frac{1}{2} \sqrt{\frac{\pi}{a}} e^{\frac{b^2-ac}{a}} \operatorname{erf}\left(\sqrt{a}x + \frac{b}{\sqrt{a}}\right) + \text{const.} \quad (a \neq 0)$$

7.4.33

$$\int e^{-a^2x^2 - \frac{b^2}{x^2}} dx = \frac{\sqrt{\pi}}{4a} \left[ e^{2ab} \operatorname{erf} \left( ax + \frac{b}{x} \right) + e^{-2ab} \operatorname{erf} \left( ax - \frac{b}{x} \right) \right] + \text{const.} \quad (a \neq 0)$$

7.4.34

$$\int e^{-a^2x^2 + \frac{b^2}{x^2}} dx = -\frac{\sqrt{\pi}}{4a} e^{-a^2x^2 + \frac{b^2}{x^2}} \left[ w \left( \frac{b}{x} + iax \right) + w \left( -\frac{b}{x} + iax \right) \right] + \text{const.} \quad (a \neq 0)$$

$$7.4.35 \quad \int \operatorname{erf} x dx = x \operatorname{erf} x + \frac{1}{\sqrt{\pi}} e^{-x^2} + \text{const.}$$

7.4.36

$$\int e^{ax} \operatorname{erf} bx dx = \frac{1}{a} \left[ e^{ax} \operatorname{erf} bx - e^{\frac{a^2}{4b^2}} \operatorname{erf} \left( bx - \frac{a}{2b} \right) \right] + \text{const.} \quad (a \neq 0)$$

7.4.37

$$\int e^{ax} \operatorname{erf} \sqrt{\frac{b}{x}} dx = \frac{1}{a} \left\{ e^{ax} \operatorname{erf} \sqrt{\frac{b}{x}} + \frac{1}{2} e^{ax - \frac{b}{x}} \left[ w \left( \sqrt{ax} + i \sqrt{\frac{b}{x}} \right) + w \left( -\sqrt{ax} + i \sqrt{\frac{b}{x}} \right) \right] \right\} + \text{const.} \quad (a \neq 0)$$

7.4.38

$$\int \cos(ax^2 + 2bx + c) dx = \sqrt{\frac{\pi}{2a}} \left\{ \cos \left( \frac{b^2 - ac}{a} \right) C \left[ \sqrt{\frac{2}{a\pi}} (ax + b) \right] + \sin \left( \frac{b^2 - ac}{a} \right) S \left[ \sqrt{\frac{2}{a\pi}} (ax + b) \right] \right\} + \text{const.}$$

7.4.39

$$\int \sin(ax^2 + 2bx + c) dx = \sqrt{\frac{\pi}{2a}} \left\{ \cos \left( \frac{b^2 - ac}{a} \right) S \left[ \sqrt{\frac{2}{a\pi}} (ax + b) \right] - \sin \left( \frac{b^2 - ac}{a} \right) C \left[ \sqrt{\frac{2}{a\pi}} (ax + b) \right] \right\} + \text{const.}$$

$$7.4.40 \quad \int C(x) dx = xC(x) - \frac{1}{\pi} \sin \left( \frac{\pi}{2} x^2 \right) + \text{const.}$$

$$7.4.41 \quad \int S(x) dx = xS(x) + \frac{1}{\pi} \cos \left( \frac{\pi}{2} x^2 \right) + \text{const.}$$

## Numerical Methods

### 7.5. Use and Extension of the Tables

**Example 1.** Compute  $\operatorname{erf} .745$  and  $e^{-(.745)^2}$  using Taylor's series.

With the aid of Taylor's theorem and 7.1.19 it can be shown that

$$\operatorname{erf} (x_0 + ph) = \operatorname{erf} x_0 + \frac{2}{\sqrt{\pi}} e^{-x_0^2} ph \left[ 1 - phx_0 + \frac{1}{3} p^2 h^2 (2x_0^2 - 1) \right] + \epsilon$$

$$e^{-(x_0 + ph)^2} = e^{-x_0^2} \left[ 1 - 2phx_0 + p^2 h^2 (2x_0^2 - 1) - \frac{2}{3} p^3 h^3 x_0 (2x_0^2 - 3) \right] + \eta$$

where  $|\epsilon| < 1.2 \times 10^{-10}$ ,  $|\eta| < 3.2 \times 10^{-10}$  if  $h = 10^{-2}$ ,  $|p| \leq \frac{1}{2}$ . With  $x_0 = .74$ ,  $p = .5$  and using Table 7.1

$$\begin{aligned} \operatorname{erf} .745 &= .70467 80779 + (.5)(.00652 58247) \times \\ &\quad [1 - (.005)(.74) + (.00000 83333)(.0952)] \\ &= .70792 8920 \end{aligned}$$

$$\begin{aligned} e^{-(.745)^2} &= \frac{\sqrt{\pi}}{2} (.65258 24665) [1 - .0074 \\ &\quad + (.000025)(.0952) + (.00000 00833)(.74)(1.9048)] \\ &= .57405 7910. \end{aligned}$$

As a check the computation was repeated with  $x_0 = .75$ ,  $p = -.5$ .

**Example 2.** Compute  $\operatorname{erfc} x$  to 5S for  $x = 4.8$ . We have  $1/x^2 = .0434028$ . With Table 7.2 and linear interpolation in Table 7.3, we obtain

$$\begin{aligned} \operatorname{erfc} 4.8 &= \frac{1}{4.8} (1.11253)(10^{-10}) (.552669) \frac{\sqrt{\pi}}{2} \\ &= (1.1352) 10^{-11}. \end{aligned}$$



## References

## Texts

- [7.1] J. Boersma, Computation of Fresnel integrals, *Math. Comp.* **14**, 380 (1960).
- [7.2] A. V. Boyd, Inequalities for Mills' ratio, *Rep. Statist. Appl. Res. Un. Jap. Sci. Engrs.* **6**, 44-46 (1959).
- [7.3] O. Emersleben, Numerische Werte des Fehlerintegrals für  $\sqrt{n\pi}$ , *Z. Angew. Math. Mech.* **31**, 393-394 (1951).
- [7.4] A. Erdélyi et al., Higher transcendental functions, vol. 2 (McGraw-Hill Book Co., Inc., New York, N.Y., Toronto, Canada, London, England, 1953).
- [7.5] A. Erdélyi et al., Tables of integral transforms, vol. 1 (McGraw-Hill Book Co., Inc., New York, N.Y., Toronto, Canada, London, England, 1954).
- [7.6] W. Gautschi, Note on bivariate linear interpolation for analytic functions, *Math. Tables Aids Comp.* **13**, 91-96 (1959).
- [7.7] W. Gautschi, Recursive computation of the repeated integrals of the error function, *Math. Comp.* **15**, 227-232 (1961).
- [7.8] W. Gröbner and N. Hofreiter, *Integraltafel* (Springer-Verlag, Wien and Innsbruck, Austria, 1949-50).
- [7.9] D. R. Hartree, Some properties and applications of the repeated integrals of the error function, *Mem. Proc. Manchester Lit. Philos. Soc.* **80**, 85-102 (1936).
- [7.10] C. Hastings, Jr., Approximations for digital computers (Princeton Univ. Press, Princeton, N.J., 1955).
- [7.11] Y. Komatu, Elementary inequalities for Mills' ratio, *Rep. Statist. Appl. Res. Un. Jap. Sci. Engrs.* **4**, 69-70 (1955-57).
- [7.12] E. Kreyszig, On the zeros of the Fresnel integrals, *Canad. J. Math.* **9**, 118-131 (1957).
- [7.13] Th. Laible, Höhenkarte des Fehlerintegrals, *Z. Angew. Math. Phys.* **2**, 484-486 (1951).
- [7.14] F. Löscher and F. Schoblik, *Die Fakultät* (B. G. Teubner, Leipzig, Germany, 1951).
- [7.15] F. Oberhettinger, Tabellen zur Fourier Transformation (Springer-Verlag, Berlin, Göttingen, Heidelberg, Germany, 1957).
- [7.16] J. R. Philip, The function  $\text{inv erfc } \Theta$ , *Austral. J. Phys.* **13**, 13-20 (1960).
- [7.17] H. O. Pollak, A remark on "Elementary inequalities for Mills' ratio" by Yūsaku Komatu, *Rep. Statist. Appl. Res. Un. Jap. Sci. Engrs.* **4**, 110 (1955-57).
- [7.18] J. B. Rosser, Theory and application of  $\int_0^x e^{-x^2} dx$  and  $\int_0^x e^{-x^2} dy \int_0^y e^{-x^2} dx$  (Mapleton House, Brooklyn, N.Y., 1948).
- [7.19] H. E. Salzer, Formulas for calculating the error function of a complex variable, *Math. Tables Aids Comp.* **5**, 67-70 (1951).
- [7.20] H. E. Salzer, Complex zeros of the error function, *J. Franklin Inst.* **260**, 209-211 (1955).
- [7.21] F. G. Tricomi, *Funzioni ipergeometriche confluenti* (Edizioni Cremonese, Rome, Italy, 1954).
- [7.22] G. N. Watson, *A treatise on the theory of Bessel functions*, 2d ed. (Cambridge Univ. Press, London, England, 1958).

## Tables

- [7.23] M. Abramowitz, Table of the integral  $\int_0^x e^{-u^3} du$ , *J. Math. Phys.* **30**, 162-163 (1951).  $x=0(.01)2.5$ , 8D.
- [7.24] P. C. Clemmow and Cara M. Munford, A table of  $\sqrt{(\frac{1}{2}\pi)}e^{\frac{1}{2}i\pi\rho^2} \int_0^\infty e^{-\frac{1}{2}i\pi\lambda^2} d\lambda$  for complex values of  $\rho$ , *Philos. Trans. Roy. Soc. London {A}*, **245**, 189-211 (1952).  $|\rho|=0(.01).8$ ,  $\arg \rho=0^\circ(1^\circ)45^\circ$ , 4D.
- [7.25] R. B. Dingle, Doreen Arndt and S. K. Roy, The integrals
- $$C_p(x) = (p!)^{-1} \int_0^\infty e^{\rho(e^2+x^2)^{-1}} e^{-t} dt$$
- and
- $$D_p(x) = (p!)^{-1} \int_0^\infty e^{\rho(e^2+x^2)^{-2}} e^{-t} dt$$
- and their tabulation, *Appl. Sci. Res. B* **6**, 155-164 (1956).  $C(x)$ ,  $S(x)$ ,  $x=0(1)20$ , 12D.
- [7.26] V. N. Faddeeva and N. M. Terent'ev, Tables of values of the function  $w(z) = e^{-z^2} \left(1 + \frac{2i}{\sqrt{\pi}} \int_0^z e^{t^2} dt\right)$  for complex argument. Translated from the Russian by D. G. Fry (Pergamon Press, New York, N.Y., 1961).  $w(z)$ ,  $z=x+iy$ ;  $x, y=0(.02)3$ ;  $x=3(.1)5$ ,  $y=0(.1)3$ ;  $x=0(.1)5$ ,  $y=3(.1)5$ ; 6D.
- [7.27] B. D. Fried and S. D. Conte, The plasma dispersion function (Academic Press, New York, N.Y. and London, England, 1961).  $i\sqrt{\pi}w(z)$ ,  $i\sqrt{\pi}w'(z)$ ,  $z=x+iy$ ;  $x=0(.1)9.9$ ,  $y=-9.1(.1)10$ ;  $x=\text{var.}$   $(.1)9.9$ ,  $y=-10(.1)-9.2$ ; 6S.
- [7.28] K. A. Karpov, *Tablitsy funktsii  $w(z) = e^{-z^2} \int_0^z e^{x^2} dx$  v kompleksnoi oblasti* (Izdat. Akad. Nauk SSSR., Moscow, U.S.S.R., 1954).  
 $z=x$ ;  $x=0(.001)2(.01)10$ ; 5D;  
 $z=\rho e^{i\theta}$ ;  $\theta=2.5^\circ(2.5^\circ)30^\circ(1.25^\circ)35^\circ(.625^\circ)40^\circ$ ;  
 $\rho=\rho_\theta(.001)\rho'_\theta(.01)\rho''_\theta(.0002)5$ ,  $0 \leq \rho_\theta \leq \rho'_\theta \leq \rho''_\theta \leq 5$ , 5D;  
 $z=iy$ ;  $y=0(.001)3(.0002)5$ , 5S.
- [7.29] K. A. Karpov, *Tablitsy funktsii  $F(z) = \int_0^z e^{x^2} dx$  v kompleksnoi oblasti* (Izdat. Akad. Nauk SSSR., Moscow, U.S.S.R., 1958).  $z=\rho e^{i\theta}$ ;  
 $\theta=45^\circ(.3125^\circ)48.75^\circ(.625^\circ)55^\circ(1.25^\circ)65^\circ(2.5^\circ)90^\circ$ ;  
 $\rho=\rho_\theta(.001)\rho'_\theta(.01)\rho''_\theta(.0002)5$ ,  $0 \leq \rho_\theta \leq \rho'_\theta \leq \rho''_\theta \leq 5$ , 5D;  
 $z=x$ ;  $x=0(.001)10$ , 5S.
- [7.30] J. Kaye, A table of the first eleven repeated integrals of the error function, *J. Math. Phys.* **34**, 119-125 (1955).  $i\text{erfc } x$ ,  $x=0(.01).2(.05)1(.1)3$ ,  $n=-1(1)11$ , 6D.
- [7.31] B. Lohmander and S. Rittsten, Table of the function  $y=e^{-x^2} \int_0^x e^{t^2} dt$ , *Kungl. Fysiogr. Sällsk. i Lund Förh.* **28**, 45-52 (1958).  $x=0(.01)3(.02)5$ ,  $x^{-1}=0(.005).2$ , 10D;  $x=.5(.5)10$ , 20D. Contains also 20D values for maximum and inflection points.

- [7.32] W. Lash Miller and A. R. Gordon, Numerical evaluation of infinite series and integrals which arise in certain problems of linear heat flow, electrochemical diffusion, etc., *J. Phys. Chem.* **35**, 2785-2884 (1931).
- $$F(x) = e^{-x^2} \int_0^x e^{t^2} dt; x=0(.01)1.99, \quad 6D;$$
- $x=2(.01)4(.05)7.5(.1)10(.2)12, \quad 8S.$
- [7.33] National Bureau of Standards, Tables of the error function and its derivative, *Applied Math. Series* 41, 2d ed. (U.S. Government Printing Office, Washington, D.C., 1954).
- $(2/\sqrt{\pi})e^{-x^2}, \operatorname{erf} x, x=0(.0001)1(.001)5.6, \quad 15D;$
- $(2/\sqrt{\pi})e^{-x^2}, \operatorname{erfc} x, x=4(.01)10, \quad 8S.$
- [7.34] T. Pearcey, Table of the Fresnel integral (Cambridge Univ. Press, London, England, 1956).
- $$C\left(\sqrt{\frac{2x}{\pi}}\right), S\left(\sqrt{\frac{2x}{\pi}}\right), x=0(.01)50, \quad 6-7D.$$
- [7.35] *Tablitsy integralov Frenelya* (Izdat. Akad. Nauk SSSR., Moscow, U.S.S.R., 1953).  $C(x), S(x), x=0(.001)25, 7D;$   $S(x), x=0(.001) .58, 7S;$   $C(x), x=0(.001) .101, 7S.$
- [7.36] A. van Wijngaarden and W. L. Scheen, Table of Fresnel integrals, *Verh. Nederl. Akad. Wetensch., Afd. Natuurk. Sec. I*, 19, No. 4, 1-26 (1949).  $C(x), S(x), x=0(.01)20, 5D.$  (Also contains numerical values of the coefficients in Taylor and asymptotic expansions.)

COMPLEX ZEROS OF THE ERROR FUNCTION

Table 7.10

| n | erf z <sub>n</sub> = 0 |                | z <sub>n</sub> = x <sub>n</sub> + iy <sub>n</sub> |                | y <sub>n</sub> |
|---|------------------------|----------------|---|----------------|----------------|
|   | x <sub>n</sub>         | y <sub>n</sub> | n   | x <sub>n</sub> |                |
| 1 | 1.45061                | 616            | 6   | 4.15899        | 840            |
| 2 | 2.24465                | 928            | 7   | 4.51631        | 940            |
| 3 | 2.83974                | 105            | 8   | 4.84797        | 031            |
| 4 | 3.33546                | 074            | 9   | 5.15876        | 791            |
| 5 | 3.76900                | 557            | 10  | 5.45219        | 220            |

$$\operatorname{erf} z_n = \operatorname{erf}(-z_n) = \operatorname{erf} \bar{z}_n = \operatorname{erf}(-\bar{z}_n) = 0$$

$$x_n \approx \frac{1}{2} \sqrt{\pi(4n-1)} \mp \frac{\ln\left(\pi\sqrt{2n-\frac{1}{4}}\right)}{2\sqrt{\pi(4n-\frac{1}{2})}} \quad (n > 0)$$

$$y_n \approx \frac{1}{2} \sqrt{\pi(4n-1)}$$

From H. E. Salzer, Complex zeros of the error function, J. Franklin Inst. 260, 209-211, 1955 (with permission).

COMPLEX ZEROS OF FRESNEL INTEGRALS

Table 7.11

| n | C(z <sub>n</sub> ) = 0 |                | z <sub>n</sub> = x <sub>n</sub> + iy <sub>n</sub> |                |
|---|------------------------|----------------|---|----------------|
|   | x <sub>n</sub>         | y <sub>n</sub> | x <sub>n</sub>                                    | y <sub>n</sub> |
| 0 | 0.0000                 | 0.0000         | 0.0000  | 0.0000         |
| 1 | 1.7437                 | 0.3057         | 2.0093  | 0.2886         |
| 2 | 2.6515                 | 0.2529         | 2.8335  | 0.2443         |
| 3 | 3.3208                 | 0.2239         | 3.4675  | 0.2185         |
| 4 | 3.8759                 | 0.2047         | 4.0026  | 0.2008         |
| 5 | 4.3611                 | 0.1909         | 4.4742  | 0.1877         |

$$C_S(z_n) = C_S(-z_n) = C_S(\bar{z}_n) = C_S(-\bar{z}_n) = C_S(iz_n) = C_S(-iz_n) = C_S(-i\bar{z}_n) = C_S(i\bar{z}_n) = 0$$

$$x_n \approx \sqrt{4n-1} - \frac{\ln(\pi\sqrt{4n-1})}{\pi^2(4n-1)^{3/2}} \quad y_n \approx \frac{\ln(\pi\sqrt{4n-1})}{\pi\sqrt{4n-1}} \quad (n > 0)$$

$$x_n^* \approx 2\sqrt{n} - \frac{\ln(2\pi\sqrt{n})}{8\pi^2n^{3/2}} \quad y_n^* \approx \frac{\ln(2\pi\sqrt{n})}{2\pi\sqrt{n}}$$

MAXIMA AND MINIMA OF FRESNEL INTEGRALS

Table 7.12

| n | M <sub>n</sub> = C(√(4n+1)) | m <sub>n</sub> = C(√(4n+3)) | M <sub>n</sub> <sup>*</sup> = S(√(4n+2)) | m <sub>n</sub> <sup>*</sup> = S(√(4n+4)) |
|---|-----------------------------|-----------------------------|--|--|
|   | M <sub>n</sub>              | m <sub>n</sub>              | M <sub>n</sub> <sup>*</sup>              | m <sub>n</sub> <sup>*</sup>              |
| 0 | 0.779893                    | 0.321056                    | 0.713972                                 | 0.343415                                 |
| 1 | 0.640807                    | 0.380389                    | 0.628940                                 | 0.387969                                 |
| 2 | 0.605721                    | 0.404260                    | 0.600361                                 | 0.408301                                 |
| 3 | 0.588128                    | 0.417922                    | 0.584942                                 | 0.420516                                 |
| 4 | 0.577121                    | 0.427036                    | 0.574957                                 | 0.428877                                 |
| 5 | 0.569413                    | 0.433666                    | 0.567822                                 | 0.435059                                 |

$$M_n \sim \frac{1}{2} + \frac{\pi^2(4n+1)^2-3}{\pi^3(4n+1)^{5/2}} \quad m_n \sim \frac{1}{2} - \frac{\pi^2(4n+3)^2-3}{\pi^3(4n+3)^{5/2}} \quad (n \rightarrow \infty)$$

$$M_n^* \sim \frac{1}{2} + \frac{\pi^2(4n+2)^2-3}{\pi^3(4n+2)^{5/2}} \quad m_n^* \sim \frac{1}{2} - \frac{16\pi^2(n+1)^2-3}{32\pi^3(n+1)^{5/2}}$$

From G. N. Watson, A treatise on the theory of Bessel functions, 2d ed. Cambridge Univ. Press, Cambridge, England, 1958 (with permission).

# 8. Legendre Functions

IRENE A. STEGUN<sup>1</sup>

## Contents

|  | Page |
|--|------|
| <b>Mathematical Properties</b> . . . . .   | 332  |
| <b>Notation</b> . . . . .  | 332  |
| 8.1. Differential Equation . . . . .   | 332  |
| 8.2. Relations Between Legendre Functions . . . . .  | 333  |
| 8.3. Values on the Cut . . . . .   | 333  |
| 8.4. Explicit Expressions . . . . .  | 333  |
| 8.5. Recurrence Relations . . . . .  | 333  |
| 8.6. Special Values . . . . .  | 334  |
| 8.7. Trigonometric Expansions . . . . .  | 335  |
| 8.8. Integral Representations . . . . .  | 335  |
| 8.9. Summation Formulas . . . . .  | 335  |
| 8.10. Asymptotic Expansions . . . . .  | 335  |
| 8.11. Toroidal Functions . . . . .   | 336  |
| 8.12. Conical Functions . . . . .  | 337  |
| 8.13. Relation to Elliptic Integrals . . . . .   | 337  |
| 8.14. Integrals . . . . .  | 337  |
| <b>Numerical Methods</b> . . . . .   | 339  |
| 8.15. Use and Extension of the Tables . . . . .  | 339  |
| <b>References</b> . . . . .  | 340  |
| <b>Table 8.1.</b> Legendre Function-First Kind $P_n(x)$ ( $x \leq 1$ ) . . . . .                     | 342  |
| $x=0(.01)1, n=0(1)3, 9, 10, 5-8D$  |      |
| <b>Table 8.2.</b> Derivative of the Legendre Function-First Kind $P'_n(x)$ ( $x \leq 1$ ) . . . . .  | 344  |
| $x=0(.01)1, n=1(1)4, 9, 10, 5-7D$  |      |
| <b>Table 8.3.</b> Legendre Function-Second Kind $Q_n(x)$ ( $x \leq 1$ ) . . . . .                    | 346  |
| $x=0(.01)1, n=0(1)3, 9, 10, 8D$  |      |
| <b>Table 8.4.</b> Derivative of the Legendre Function-Second Kind $Q'_n(x)$ ( $x \leq 1$ ) . . . . . | 348  |
| $x=0(.01)1, n=0(1)3, 9, 10, 6-8D$  |      |
| <b>Table 8.5.</b> Legendre Function-First Kind $P_n(x)$ ( $x \geq 1$ ) . . . . .                     | 350  |
| $x=1(.2)10, n=0(1)5, 9, 10, \text{ exact or } 6S$  |      |
| <b>Table 8.6.</b> Derivative of the Legendre Function-First Kind $P'_n(x)$ ( $x \geq 1$ ) . . . . .  | 351  |
| $x=1(.2)10, n=1(1)5, 9, 10, 6S$  |      |
| <b>Table 8.7.</b> Legendre Function-Second Kind $Q_n(x)$ ( $x \geq 1$ ) . . . . .                    | 352  |
| $x=1(.2)10, n=0(1)3, 9, 10, 6S$  |      |
| <b>Table 8.8.</b> Derivative of the Legendre Function-Second Kind $Q'_n(x)$ ( $x \geq 1$ ) . . . . . | 353  |
| $x=1(.2)10, n=0(1)3, 9, 10, 6S$  |      |

The author acknowledges the assistance of Ruth E. Capuano, Elizabeth F. Godefroy, David S. Liepman, and Bertha H. Walter in the preparation and checking of the tables and examples.

<sup>1</sup> National Bureau of Standards.

# 8. Legendre Functions

## Mathematical Properties

### Notation

The conventions used are  $z=x+iy$ ,  $x, y$  real, and in particular,  $x$  always means a real number in the interval  $-1 \leq x \leq +1$  with  $\cos \theta = x$  where  $\theta$  is likewise a real number;  $n$  and  $m$  are positive integers or zero;  $\nu$  and  $\mu$  are unrestricted except where otherwise indicated.

Other notations are:

$$P^n(x) \text{ for } \frac{n!P_n(x)}{(2n-1)!!}$$

$$P_{nm}(x) \text{ for } (-1)^m P_n^m(x)$$

$$T_n^m(x) \text{ for } (-1)^m P_n^m(x)$$

$$\overline{P}_n^m(x) \text{ for } (-1)^m \sqrt{\frac{(2n+1)(n-m)!}{2(n+m)!}} P_n^m(x)$$

$$\mathfrak{P}_\nu^\mu(z) \text{ for } P_\nu^\mu(z), \mathfrak{Q}_\nu^\mu(z) \text{ for } Q_\nu^\mu(z) \quad (\Re z > 1)$$

$$\mathfrak{Q}_\nu^\mu(z) \text{ for } e^{i\mu\pi} Q_\nu^\mu(z)$$

$$Q_\nu^\mu(z) \text{ for } \frac{\sin(\nu+u)\pi}{\sin \nu\pi} Q_\nu^\mu(z)$$

Various other definitions of the functions occur as well as mixing of definitions.

### 8.1. Differential Equation

#### 8.1.1

$$(1-z^2) \frac{d^2 w}{dz^2} - 2z \frac{dw}{dz} + [\nu(\nu+1) - \frac{\mu^2}{1-z^2}] w = 0$$

#### Solutions

(Degree  $\nu$  and order  $\mu$  with singularities at  $z = \pm 1, \infty$  as ordinary branch points— $\mu, \nu$  arbitrary complex constants.)

$P_\nu^\mu(z), Q_\nu^\mu(z)$ —Associated Legendre Functions (Spherical Harmonics) of the First and Second Kinds<sup>2</sup>

$$|\arg(z \pm 1)| < \pi, \quad |\arg z| < \pi$$

$$(z^2 - 1)^{\frac{1}{2}\mu} = (z-1)^{\frac{1}{2}\mu} (z+1)^{\frac{1}{2}\mu}$$

(For  $P_\nu^\mu(z)$ ,  $\mu=0$ , Legendre polynomials, see chapter 22.)

#### 8.1.2

$$P_\nu^\mu(z) = \frac{1}{\Gamma(1-\mu)} \left[ \frac{z+1}{z-1} \right]^{\frac{1}{2}\mu} F\left(-\nu, \nu+1; 1-\mu; \frac{1-z}{2}\right) \quad (|1-z| < 2)$$

(For  $F(a, b; c; z)$  see chapter 15.)

$$8.1.3 \quad Q_\nu^\mu(z) = e^{i\mu\pi} 2^{-\nu-1} \pi^{\frac{1}{2}} \frac{\Gamma(\nu+\mu+1)}{\Gamma(\nu+\frac{3}{2})} z^{-\nu-\mu-1} (z^2-1)^{\frac{1}{2}\mu} F\left(1+\frac{\nu}{2}+\frac{\mu}{2}, \frac{1}{2}+\frac{\nu}{2}+\frac{\mu}{2}; \nu+\frac{3}{2}; \frac{1}{z^2}\right) \quad (|z| > 1)$$

#### Alternate Forms

(Additional forms may be obtained by means of the transformation formulas of the hypergeometric function, see [8.1].)

$$8.1.4 \quad P_\nu^\mu(z) = 2^\mu \pi^{\frac{1}{2}} (z^2-1)^{-\frac{1}{2}\mu} \left\{ \frac{F\left(-\frac{\nu}{2}-\frac{\mu}{2}, \frac{1}{2}+\frac{\nu}{2}-\frac{\mu}{2}, \frac{1}{2}; z^2\right)}{\Gamma\left(\frac{1}{2}-\frac{\nu}{2}-\frac{\mu}{2}\right) \Gamma\left(1+\frac{\nu}{2}-\frac{\mu}{2}\right)} - 2z \frac{F\left(\frac{1}{2}-\frac{\nu}{2}-\frac{\mu}{2}, 1+\frac{\nu}{2}-\frac{\mu}{2}, \frac{3}{2}; z^2\right)}{\Gamma\left(\frac{1}{2}+\frac{\nu}{2}-\frac{\mu}{2}\right) \Gamma\left(-\frac{\nu}{2}-\frac{\mu}{2}\right)} \right\} \quad (|z^2| < 1)$$

$$8.1.5 \quad P_\nu^\mu(z) = \frac{2^{-\nu-1} \pi^{-\frac{1}{2}} \Gamma\left(-\frac{1}{2}-\nu\right) z^{-\nu+\mu-1}}{(z^2-1)^{\mu/2} \Gamma(-\nu-\mu)} F\left(\frac{1}{2}+\frac{\nu}{2}-\frac{\mu}{2}, 1+\frac{\nu}{2}-\frac{\mu}{2}; \nu+\frac{3}{2}; z^{-2}\right) + \frac{2^\nu \Gamma\left(\frac{1}{2}+\nu\right) z^{\nu+\mu}}{(z^2-1)^{\mu/2} \Gamma(1+\nu-\mu)} F\left(-\frac{\nu}{2}-\frac{\mu}{2}, \frac{1}{2}-\frac{\nu}{2}-\frac{\mu}{2}, \frac{1}{2}-\nu; z^{-2}\right) \quad (|z^{-2}| < 1)$$

$$8.1.6 \quad e^{-i\mu\pi} Q_\nu^\mu(z) = \frac{\Gamma(1+\nu+\mu) \Gamma(-\mu) (z-1)^{\frac{1}{2}\mu} (z+1)^{-\frac{1}{2}\mu}}{2\Gamma(1+\nu-\mu)} F\left(-\nu, 1+\nu; 1+\mu; \frac{1-z}{2}\right) + \frac{1}{2} \Gamma(\mu) (z+1)^{\frac{1}{2}\mu} (z-1)^{-\frac{1}{2}\mu} F\left(-\nu, 1+\nu; 1-\mu; \frac{1-z}{2}\right) \quad (|1-z| < 2)^*$$

<sup>2</sup> The functions  $Y_n^m(\theta, \varphi) = \frac{\cos m\varphi}{\sin m\varphi} P_n^m(\cos \theta)$  called surface harmonics of the first kind, tesseral for  $m < n$  and sectorial for  $m = n$ . With  $0 \leq \theta \leq \pi, 0 \leq \varphi \leq 2\pi$ , they are everywhere one valued and continuous functions on the surface of the unit sphere  $x^2 + y^2 + z^2 = 1$  where  $x = \sin \theta \cos \varphi, y = \sin \theta \sin \varphi$  and  $z = \cos \theta$ .

\*See page II.

$$8.1.7 \quad e^{-i\mu\pi} Q_\nu^\mu(z) = \pi^{1/2} 2^\mu (z^2-1)^{-1/2} \left\{ \frac{\Gamma\left(\frac{1}{2} + \frac{\nu}{2} + \frac{\mu}{2}\right)}{2\Gamma\left(1 + \frac{\nu}{2} - \frac{\mu}{2}\right)} e^{\pm i\frac{1}{2}\pi(\mu-\nu-1)} F\left(-\frac{\nu}{2} - \frac{\mu}{2}, \frac{1}{2} + \frac{\nu}{2} - \frac{\mu}{2}, \frac{1}{2}; z^2\right) + \frac{z\Gamma\left(1 + \frac{\nu}{2} + \frac{\mu}{2}\right) e^{\pm i\frac{1}{2}\pi(\mu-\nu)}}{\Gamma\left(\frac{1}{2} + \frac{\nu}{2} - \frac{\mu}{2}\right)} F\left(\frac{1}{2} - \frac{\nu}{2} - \frac{\mu}{2}, 1 + \frac{\nu}{2} - \frac{\mu}{2}, \frac{3}{2}; z^2\right) \right\} \quad (|z^2| < 1)$$

**Wronskian**

(Upper and lower signs according as  $\mathcal{R}z \geq 0$ .)

8.1.8

$$W\{P_\nu^\mu(z), Q_\nu^\mu(z)\} = \frac{e^{i\mu\pi} 2^{2\mu} \Gamma\left(\frac{\nu+\mu+2}{2}\right) \Gamma\left(\frac{\nu+\mu+1}{2}\right)}{(1-z^2) \Gamma\left(\frac{\nu-\mu+2}{2}\right) \Gamma\left(\frac{\nu-\mu+1}{2}\right)}$$

8.3.2

$$P_\nu^\mu(x) = e^{\pm i\mu\pi} P_\nu^\mu(x \pm i0) \quad *$$

8.3.3

$$= i\pi^{-1} e^{-i\mu\pi} [e^{-i\mu\pi} Q_\nu^\mu(x+i0) - e^{i\mu\pi} Q_\nu^\mu(x-i0)] \quad *$$

8.3.4

$$Q_\nu^\mu(x) = \frac{1}{2} e^{-i\mu\pi} [e^{-i\mu\pi} Q_\nu^\mu(x+i0) + e^{i\mu\pi} Q_\nu^\mu(x-i0)]$$

(Formulas for  $P_\nu^\mu(x)$  and  $Q_\nu^\mu(x)$  are obtained with the replacement of  $z-1$  by  $(1-x)e^{\pm i\pi}$ ,  $(z^2-1)$  by  $(1-x^2)e^{\pm i\pi}$ ,  $z+1$  by  $x+1$  for  $z=x \pm i0$ .)

8.1.9  $W\{P_n(z), Q_n(z)\} = -(z^2-1)^{-1}$

**8.2. Relations Between Legendre Functions**

**Negative Degree**

8.2.1  $P_{\nu-1}^\mu(z) = P_\nu^\mu(z)$

8.2.2

$$Q_{\nu-1}^\mu(z) = \{-\pi e^{i\mu\pi} \cos \nu\pi P_\nu^\mu(z) + Q_\nu^\mu(z) \sin[\pi(\nu+\mu)]\} / \sin[\pi(\nu-\mu)]$$

**Negative Argument ( $\mathcal{R}z \geq 0$ )**

8.2.3

$$P_\nu^\mu(-z) = e^{\mp i\mu\pi} P_\nu^\mu(z) - \frac{2}{\pi} e^{-i\mu\pi} \sin[\pi(\nu+\mu)] Q_\nu^\mu(z)$$

8.2.4

$$Q_\nu^\mu(-z) = -e^{\pm i\mu\pi} Q_\nu^\mu(z)$$

**Negative Order**

8.2.5

$$P_\nu^{-\mu}(z) = \frac{\Gamma(\nu-\mu+1)}{\Gamma(\nu+\mu+1)} \left[ P_\nu^\mu(z) - \frac{2}{\pi} e^{-i\mu\pi} \sin(\mu\pi) Q_\nu^\mu(z) \right]$$

8.2.6

$$Q_\nu^{-\mu}(z) = e^{-2i\mu\pi} \frac{\Gamma(\nu-\mu+1)}{\Gamma(\nu+\mu+1)} Q_\nu^\mu(z)$$

**Degree  $\mu + \frac{1}{2}$  and Order  $\nu + \frac{1}{2}$**

$\mathcal{R}z > 0$

8.2.7  $P_{-\nu-\frac{1}{2}}^{-\mu-\frac{1}{2}}\left(\frac{z}{(z^2-1)^{1/2}}\right) = \frac{(z^2-1)^{1/4} e^{-i\mu\pi} Q_\nu^\mu(z)}{(\frac{1}{2}\pi)^{1/2} \Gamma(\nu+\mu+1)}$  \*

8.2.8

$$Q_{-\nu-\frac{1}{2}}^{-\mu-\frac{1}{2}}\left(\frac{z}{(z^2-1)^{1/2}}\right) = -i(\frac{1}{2}\pi)^{1/2} \Gamma(-\nu-\mu) (z^2-1)^{1/4} e^{-i\mu\pi} P_\nu^\mu(z)$$

**8.3. Values on the Cut**

$(-1 < x < 1)$

8.3.1

$$P_\nu^\mu(x) = \frac{1}{2} [e^{i\mu\pi} P_\nu^\mu(x+i0) + e^{-i\mu\pi} P_\nu^\mu(x-i0)]$$

**8.4. Explicit Expressions**

$(x = \cos \theta)$

8.4.1

$$P_0(z) = 1 \quad P_0(x) = 1$$

8.4.2

$$Q_0(z) = \frac{1}{2} \ln\left(\frac{z+1}{z-1}\right) \quad Q_0(x) = \frac{1}{2} \ln\left(\frac{1+x}{1-x}\right) = xF\left(\frac{1}{2}, 1; \frac{3}{2}; x^2\right)$$

8.4.3

$$P_1(z) = z \quad P_1(x) = x = \cos \theta$$

8.4.4

$$Q_1(z) = \frac{z}{2} \ln\left(\frac{z+1}{z-1}\right) - 1 \quad Q_1(x) = \frac{x}{2} \ln\left(\frac{1+x}{1-x}\right) - 1$$

8.4.5

$$P_2(z) = \frac{1}{2}(3z^2-1) \quad P_2(x) = \frac{1}{2}(3x^2-1) = \frac{1}{4}(3 \cos 2\theta + 1)$$

8.4.6

$$Q_2(z) = \frac{1}{2} P_2(z) \ln\left(\frac{z+1}{z-1}\right) \quad Q_2(x) = -\frac{3x}{2} \left(\frac{3x^2-1}{4}\right) \ln\left(\frac{1+x}{1-x}\right) - \frac{3x}{2}$$

**8.5. Recurrence Relations**

(Both  $P_\nu^\mu$  and  $Q_\nu^\mu$  satisfy the same recurrence relations.)

**Varying Order**

8.5.1

$$P_\nu^{\mu+1}(z) = (z^2-1)^{-1} \{(\nu-\mu)zP_\nu^\mu(z) - (\nu+\mu)P_{\nu-1}^\mu(z)\}$$

\*See page II.

## 8.5.2

$$(z^2-1) \frac{dP_\nu^\mu(z)}{dz} = (\nu+\mu)(\nu-\mu+1)(z^2-1)^{\frac{1}{2}} P_{\nu-1}^\mu(z) - \mu z P_\nu^\mu(z)$$

## Varying Degree

## 8.5.3

$$(\nu-\mu+1)P_{\nu+1}^\mu(z) = (2\nu+1)zP_\nu^\mu(z) - (\nu+\mu)P_{\nu-1}^\mu(z)$$

$$8.5.4 \quad (z^2-1) \frac{dP_\nu^\mu(z)}{dz} = \nu z P_\nu^\mu(z) - (\nu+\mu)P_{\nu-1}^\mu(z)$$

## Varying Order and Degree

$$8.5.5 \quad P_{\nu+1}^\mu(z) = P_{\nu-1}^\mu(z) + (2\nu+1)(z^2-1)^{\frac{1}{2}} P_\nu^{\mu-1}(z)$$

## 8.6. Special Values

$$x=0$$

## 8.6.1

$$P_\nu^\mu(0) = 2^\mu \pi^{-\frac{1}{2}} \cos \left[ \frac{1}{2} \pi (\nu + \mu) \right] \Gamma \left( \frac{1}{2} \nu + \frac{1}{2} \mu + \frac{1}{2} \right) / \Gamma \left( \frac{1}{2} \nu - \frac{1}{2} \mu + 1 \right)$$

## 8.6.2

$$Q_\nu^\mu(0) = -2^{\mu-1} \pi^{\frac{1}{2}} \sin \left[ \frac{1}{2} \pi (\nu + \mu) \right] \Gamma \left( \frac{1}{2} \nu + \frac{1}{2} \mu + \frac{1}{2} \right) / \Gamma \left( \frac{1}{2} \nu - \frac{1}{2} \mu + 1 \right)$$

## 8.6.3

$$\left[ \frac{dP_\nu^\mu(x)}{dx} \right]_{x=0} = 2^{\mu+1} \pi^{-\frac{1}{2}} \sin \left[ \frac{1}{2} \pi (\nu + \mu) \right] \Gamma \left( \frac{1}{2} \nu + \frac{1}{2} \mu + 1 \right) / \Gamma \left( \frac{1}{2} \nu - \frac{1}{2} \mu + \frac{1}{2} \right)$$

## 8.6.4

$$\left[ \frac{dQ_\nu^\mu(x)}{dx} \right]_{x=0} = 2^\mu \pi^{\frac{1}{2}} \cos \left[ \frac{1}{2} \pi (\nu + \mu) \right] \Gamma \left( \frac{1}{2} \nu + \frac{1}{2} \mu + 1 \right) / \Gamma \left( \frac{1}{2} \nu - \frac{1}{2} \mu + \frac{1}{2} \right)$$

## 8.6.5

$$W \{ P_\nu^\mu(x), Q_\nu^\mu(x) \}_{x=0} = \frac{2^{2\mu} \Gamma \left( \frac{1}{2} \nu + \frac{1}{2} \mu + 1 \right) \Gamma \left( \frac{1}{2} \nu + \frac{1}{2} \mu + \frac{1}{2} \right)}{\Gamma \left( \frac{1}{2} \nu - \frac{1}{2} \mu + 1 \right) \Gamma \left( \frac{1}{2} \nu - \frac{1}{2} \mu + \frac{1}{2} \right)}$$

$$\mu = m = 1, 2, 3, \dots$$

## 8.6.6

$$P_\nu^m(z) = (z^2-1)^{\frac{1}{2}m} \frac{d^m P_\nu(z)}{dz^m},$$

$$P_\nu^m(x) = (-1)^m (1-x^2)^{\frac{1}{2}m} \frac{d^m P_\nu(x)}{dx^m}$$

## 8.6.7

$$Q_\nu^m(z) = (z^2-1)^{\frac{1}{2}m} \frac{d^m Q_\nu(z)}{dz^m},$$

$$Q_\nu^m(x) = (-1)^m (1-x^2)^{\frac{1}{2}m} \frac{d^m Q_\nu(x)}{dx^m}$$

$$\mu = \pm \frac{1}{2}$$

## 8.6.8

$$P_\nu^{\frac{1}{2}}(z) = (z^2-1)^{-1/4} (2\pi)^{-1/2} \{ [z + (z^2-1)^{1/2}]^{\nu+\frac{1}{2}} + [z + (z^2-1)^{1/2}]^{-\nu-\frac{1}{2}} \}$$

## 8.6.9

$$P_\nu^{-\frac{1}{2}}(z) = \left( \frac{2}{\pi} \right)^{1/2} \frac{(z^2-1)^{-1/4}}{2\nu+1} \{ [z + (z^2-1)^{1/2}]^{\nu+\frac{1}{2}} - [z + (z^2-1)^{1/2}]^{-\nu-\frac{1}{2}} \}$$

## 8.6.10

$$Q_\nu^{\frac{1}{2}}(z) = i \left( \frac{1}{2} \pi \right)^{1/2} (z^2-1)^{-1/4} [z + (z^2-1)^{1/2}]^{-\nu-\frac{1}{2}}$$

## 8.6.11

$$Q_\nu^{-\frac{1}{2}}(z) = -i (2\pi)^{1/2} \frac{(z^2-1)^{-1/4}}{2\nu+1} [z + (z^2-1)^{1/2}]^{-\nu-\frac{1}{2}} \quad *$$

## 8.6.12

$$P_\nu^{\frac{1}{2}}(\cos \theta) = \left( \frac{1}{2} \pi \right)^{-\frac{1}{2}} (\sin \theta)^{-\frac{1}{2}} \cos \left[ \left( \nu + \frac{1}{2} \right) \theta \right]$$

## 8.6.13

$$Q_\nu^{\frac{1}{2}}(\cos \theta) = - \left( \frac{1}{2} \pi \right)^{\frac{1}{2}} (\sin \theta)^{-\frac{1}{2}} \sin \left[ \left( \nu + \frac{1}{2} \right) \theta \right]$$

## 8.6.14

$$P_\nu^{-\frac{1}{2}}(\cos \theta) = \left( \frac{1}{2} \pi \right)^{-\frac{1}{2}} \left( \nu + \frac{1}{2} \right)^{-1} (\sin \theta)^{-\frac{1}{2}} \sin \left[ \left( \nu + \frac{1}{2} \right) \theta \right]$$

## 8.6.15

$$Q_\nu^{-\frac{1}{2}}(\cos \theta) = (2\pi)^{-\frac{1}{2}} (2\nu+1)^{-1} (\sin \theta)^{-\frac{1}{2}} \cos \left[ \left( \nu + \frac{1}{2} \right) \theta \right] \quad *$$

$$\mu = -\nu$$

## 8.6.16

$$P_\nu^{-\nu}(z) = \frac{2^{-\nu} (z^2-1)^{\frac{1}{2}\nu}}{\Gamma(\nu+1)}$$

## 8.6.17

$$P_\nu^{-\nu}(\cos \theta) = \frac{2^{-\nu} (\sin \theta)^\nu}{\Gamma(\nu+1)}$$

$$\mu = 0, \nu = n$$

## (Rodrigues' Formula)

## 8.6.18

$$P_n(z) = \frac{1}{2^n n!} \frac{d^n (z^2-1)^n}{dz^n}$$

## 8.6.19

$$Q_n(x) = \frac{1}{2} P_n(x) \ln \frac{1+x}{1-x} - W_{n-1}(x)$$

where

$$W_{n-1}(x) = \frac{2n-1}{1 \cdot n} P_{n-1}(x) + \frac{2n-5}{3(n-1)} P_{n-3}(x) + \frac{2n-9}{5(n-2)} P_{n-5}(x) + \dots$$

$$= \sum_{m=1}^n \frac{1}{m} P_{m-1}(x) P_{n-m}(x)$$

$$W_{-1}(x) = 0$$

\*See page II.



$$\nu=0, 1$$

$$8.6.20 \quad \left[ \frac{\partial P_\nu(\cos \theta)}{\partial \nu} \right]_{\nu=0} = 2 \ln (\cos \frac{1}{2}\theta)$$

$$8.6.21 \quad \left[ \frac{\partial P_\nu^{-1}(\cos \theta)}{\partial \nu} \right]_{\nu=0} = -\tan \frac{1}{2}\theta - 2 \cot \frac{1}{2}\theta \ln (\cos \frac{1}{2}\theta)$$

$$8.6.22 \quad \left[ \frac{\partial P_\nu^{-1}(\cos \theta)}{\partial \nu} \right]_{\nu=1} = -\frac{1}{2} \tan \frac{1}{2}\theta \sin^2 \frac{1}{2}\theta + \sin \theta \ln (\cos \frac{1}{2}\theta)$$

**8.7. Trigonometric Expansions** ( $0 < \theta < \pi$ )

$$8.7.1 \quad P_\nu^\mu(\cos \theta) = \pi^{-1/2} 2^{\mu+1} (\sin \theta)^\mu \frac{\Gamma(\nu+\mu+1)}{\Gamma(\nu+\frac{3}{2})} \sum_{k=0}^{\infty} \frac{(\mu+\frac{1}{2})_k (\nu+\mu+1)_k}{k! (\nu+\frac{3}{2})_k} \sin [(\nu+\mu+2k+1)\theta]$$

$$8.7.2 \quad Q_\nu^\mu(\cos \theta) = \pi^{1/2} 2^\mu (\sin \theta)^\mu \frac{\Gamma(\nu+\mu+1)}{\Gamma(\nu+\frac{3}{2})} \sum_{k=0}^{\infty} \frac{(\mu+\frac{1}{2})_k (\nu+\mu+1)_k}{k! (\nu+\frac{3}{2})_k} \cos [(\nu+\mu+2k+1)\theta]$$

$$8.7.3 \quad P_n(\cos \theta) = \frac{2^{2n+2} (n!)^2}{\pi (2n+1)!} \left[ \sin (n+1)\theta + \frac{n+1}{2n+3} \sin (n+3)\theta + \frac{1 \cdot 3}{2!} \frac{(n+1)(n+2)}{(2n+3)(2n+5)} \sin (n+5)\theta + \dots \right]$$

$$8.7.4 \quad Q_n(\cos \theta) = \frac{2^{2n+1} (n!)^2}{(2n+1)!} \left[ \cos (n+1)\theta + \frac{n+1}{2n+3} \cos (n+3)\theta + \frac{1 \cdot 3}{2!} \frac{(n+1)(n+2)}{(2n+3)(2n+5)} \cos (n+5)\theta + \dots \right]$$

**8.8. Integral Representations**

( $z$  not on the real axis between  $-1$  and  $-\infty$ )

$$8.8.1 \quad P_\nu^\mu(z) = \frac{2^{-\nu} (z^2-1)^{-\frac{1}{2}\mu}}{\Gamma(-\nu-\mu)\Gamma(\nu+1)} \int_0^\infty (z+\cosh t)^{\mu-\nu-1} (\sinh t)^{2\nu+1} dt \quad (\Re(-\mu) > \Re \nu > -1) \quad *$$

$$8.8.2 \quad Q_\nu^\mu(z) = \frac{e^{i\mu\pi} \sqrt{\pi} 2^{-\mu} \Gamma(\nu+\mu+1)}{\Gamma(\mu+\frac{1}{2}) \Gamma(\nu-\mu+1)} (z^2-1)^{\frac{1}{2}\mu} \int_0^\infty [z+(z^2-1)^{\frac{1}{2}} \cosh t]^{-\nu-\mu-1} (\sinh t)^{2\mu} dt \quad (\Re(\nu \pm \mu + 1) > 0) \quad *$$

$$8.8.3 \quad Q_n(z) = \frac{1}{2} \int_{-1}^1 (z-t)^{-1} P_n(t) dt = (-1)^{n+1} Q_n(-z)$$

(For other integral representations see [8.2].)

**8.9. Summation Formulas**

$$8.9.1 \quad (\xi-z) \sum_{m=0}^n (2m+1) P_m(z) P_m(\xi) = (n+1) [P_{n+1}(\xi) P_n(z) - P_n(\xi) P_{n+1}(z)]$$

$$8.9.2 \quad (\xi-z) \sum_{m=0}^n (2m+1) P_m(z) Q_m(\xi) = 1 - (n+1) [P_{n+1}(z) Q_n(\xi) - P_n(z) Q_{n+1}(\xi)]$$

**8.10. Asymptotic Expansions**

For fixed  $z$  and  $\nu$  and  $\Re \mu \rightarrow \infty$ , 8.10.1-8.10.3 are asymptotic expansions if  $z$  is not on the real axis between  $-\infty$  and  $-1$  and  $+\infty$  and  $+1$ . (Upper or lower signs according as  $\Im z \geq 0$ .)

$$8.10.1 \quad P_\nu^\mu(z) = \frac{\Gamma(\nu+\mu+1)\Gamma(\mu-\nu)}{\pi\Gamma(\mu+1)} \left(\frac{z+1}{z-1}\right)^{\frac{1}{2}\mu} \sin \mu\pi \left[ F(-\nu, \nu+1; 1+\mu; \frac{1}{2}+\frac{1}{2}z) - \frac{\sin \nu\pi}{\sin \mu\pi} e^{\mp i\mu\pi} \left(\frac{z-1}{z+1}\right)^\mu F(-\nu, \nu+1; 1+\mu; \frac{1}{2}-\frac{1}{2}z) \right]$$

$$8.10.2 \quad Q_\nu^\mu(z) = \frac{1}{2} e^{i\mu\pi} \frac{\Gamma(\nu+\mu+1)}{\Gamma(\mu+1)} \left(\frac{z+1}{z-1}\right)^{\frac{1}{2}\mu} \Gamma(\mu-\nu) \left[ F(-\nu, \nu+1; 1+\mu; \frac{1}{2}+\frac{1}{2}z) - e^{\mp i\mu\pi} \left(\frac{z-1}{z+1}\right)^\mu F(-\nu, \nu+1; 1+\mu; \frac{1}{2}-\frac{1}{2}z) \right]$$

\*See page II.

$$8.10.3 \quad Q_{\nu}^{-\mu}(z) = \frac{e^{-i\mu\pi} \csc[\pi(\nu-\mu)]}{2\pi\Gamma(1+\mu)} \left[ e^{\mp i\nu\pi} \left(\frac{z+1}{z-1}\right)^{-\frac{1}{2}\mu} F(-\nu, \nu+1; 1+\mu; \frac{1}{2}-\frac{1}{2}z) \right. \\ \left. - \left(\frac{z-1}{z+1}\right)^{-\frac{1}{2}\mu} F(-\nu, \nu+1; 1+\mu; \frac{1}{2}+\frac{1}{2}z) \right]$$

With  $\mu$  replaced by  $-\mu$ , 8.1.2 is an asymptotic expansion for  $P_{\nu}^{-\mu}(z)$  for fixed  $z$  and  $\nu$  and  $\mathcal{R} \mu \rightarrow \infty$  if  $z$  is not on the real axis between  $-\infty$  and  $-1$ .

For fixed  $z$  and  $\mu$  and  $\mathcal{R} \nu \rightarrow \infty$ , 8.10.4 and 8.10.6 are asymptotic expansions if  $z$  is not on the real axis between  $-\infty$  and  $-1$  and  $+\infty$  and  $+1$ ; 8.10.5 if  $z$  is not on the real axis between  $-\infty$  and  $+1$ .

$$8.10.4 \quad P_{\nu}^{\mu}(z) = (2\pi)^{-\frac{1}{2}} (z^2-1)^{-1/4} \frac{\Gamma(\nu+\mu+1)}{\Gamma(\nu+\frac{3}{2})} \left\{ [z+(z^2-1)^{\frac{1}{2}}]^{2\nu+1} F(\frac{1}{2}+\mu, \frac{1}{2}-\mu; \frac{3}{2}+\nu; \frac{z+(z^2-1)^{\frac{1}{2}}}{2(z^2-1)^{\frac{1}{2}}}) \right. \\ \left. + i e^{-i\mu\pi} [z-(z^2-1)^{\frac{1}{2}}]^{2\nu+1} F(\frac{1}{2}+\mu, \frac{1}{2}-\mu; \frac{3}{2}+\nu; \frac{-z+(z^2-1)^{\frac{1}{2}}}{2(z^2-1)^{\frac{1}{2}}}) \right\}$$

$$8.10.5 \quad Q_{\nu}^{\mu}(z) = e^{i\mu\pi} (\frac{1}{2}\pi)^{\frac{1}{2}} (z^2-1)^{-1/4} \frac{\Gamma(\nu+\mu+1)}{\Gamma(\nu+\frac{3}{2})} [z-(z^2-1)^{\frac{1}{2}}]^{2\nu+1} F(\frac{1}{2}+\mu, \frac{1}{2}-\mu; \frac{3}{2}+\nu; \frac{-z+(z^2-1)^{\frac{1}{2}}}{2(z^2-1)^{\frac{1}{2}}})$$

$$8.10.6 \quad Q_{\nu}^{\mu}(z) = \frac{e^{i\mu\pi} (\frac{1}{2}\pi)^{\frac{1}{2}} (z^2-1)^{-1/4} \Gamma(\mu+\nu)}{\sin[\pi(\mu-\nu)] \Gamma(\frac{1}{2}-\mu)} \left\{ \cos \nu\pi [z+(z^2-1)^{\frac{1}{2}}]^{2\nu-1} F(\frac{1}{2}+\mu, \frac{1}{2}-\mu; \frac{1}{2}+\nu; \frac{z+(z^2-1)^{\frac{1}{2}}}{2(z^2-1)^{\frac{1}{2}}}) \right. \\ \left. + i e^{i\nu\pi} \cos \mu\pi [z-(z^2-1)^{\frac{1}{2}}]^{2\nu-1} F(\frac{1}{2}+\mu, \frac{1}{2}-\mu; \frac{1}{2}+\nu; \frac{-z+(z^2-1)^{\frac{1}{2}}}{2(z^2-1)^{\frac{1}{2}}}) \right\}$$

The related asymptotic expansion for  $P_{\nu}^{\mu}(z)$  may be derived from 8.10.4 together with 8.2.1.

$$8.10.7 \quad P_{\nu}^{\mu}(\cos \theta) = \frac{\Gamma(\nu+\mu+1)}{\Gamma(\nu+\frac{3}{2})} (\frac{1}{2}\pi \sin \theta)^{-\frac{1}{2}} \cos[(\nu+\frac{1}{2})\theta - \frac{\pi}{4} + \frac{\mu\pi}{2}] + O(\nu^{-1})$$

$$8.10.8 \quad Q_{\nu}^{\mu}(\cos \theta) = \frac{\Gamma(\nu+\mu+1)}{\Gamma(\nu+\frac{3}{2})} \left(\frac{\pi}{2 \sin \theta}\right)^{\frac{1}{2}} \cos[(\nu+\frac{1}{2})\theta + \frac{\pi}{4} + \frac{\mu\pi}{2}] + O(\nu^{-1}) \quad (\epsilon < \theta < \pi - \epsilon, \epsilon > 0)$$

For other asymptotic expansions, see [8.7] and [8.9].

### 8.11. Toroidal Functions (or Ring Functions)

(Only special properties are given; other properties and representations follow from the earlier sections.)

$$8.11.1 \quad P_{\nu-\frac{1}{2}}^{\mu}(\cosh \eta) = [\Gamma(1-\mu)]^{-1} 2^{2\mu} (1-e^{-2\eta})^{-\mu} e^{-(\nu+\frac{1}{2})\eta} F(\frac{1}{2}-\mu, \frac{1}{2}+\nu-\mu; 1-2\mu; 1-e^{-2\eta})$$

$$8.11.2 \quad P_{n-\frac{1}{2}}^m(\cosh \eta) = \frac{\Gamma(n+m+\frac{1}{2})(\sinh \eta)^m}{\Gamma(n-m+\frac{1}{2}) 2^m \sqrt{\pi} \Gamma(m+\frac{1}{2})} \int_0^{\pi} \frac{(\sin \varphi)^{2m} d\varphi}{(\cosh \eta + \cos \varphi \sinh \eta)^{n+m+\frac{1}{2}}}$$

$$8.11.3 \quad Q_{\nu-\frac{1}{2}}^{\mu}(\cosh \eta) = [\Gamma(1+\nu)]^{-1} \sqrt{\pi} e^{i\mu\pi} \Gamma(\frac{1}{2}+\nu+\mu) (1-e^{-2\eta})^{\mu} e^{-(\nu+\frac{1}{2})\eta} F(\frac{1}{2}+\mu, \frac{1}{2}+\nu+\mu; 1+\nu; e^{-2\eta}) \quad *$$

$$8.11.4 \quad Q_{n-\frac{1}{2}}^m(\cosh \eta) = \frac{(-1)^m \Gamma(n+\frac{1}{2})}{\Gamma(n-m+\frac{1}{2})} \int_0^{\infty} \frac{\cosh mt dt}{(\cosh \eta + \cosh t \sinh \eta)^{n+\frac{1}{2}}} \quad * \quad (n > m)$$

\*See page II.

8.12. Conical Functions

$$(P_{-\frac{1}{2}+i\lambda}^{\mu}(\cos \theta), Q_{-\frac{1}{2}+i\lambda}^{\mu}(\cos \theta))$$

(Only special properties are given as other properties and representations follow from earlier sections with  $\nu = -\frac{1}{2} + i\lambda$  ( $\lambda$ , a real parameter) and  $z = \cos \theta$ .)

8.12.1

$$P_{-\frac{1}{2}+i\lambda}(\cos \theta) = 1 + \frac{4\lambda^2 + 1^2}{2^2} \sin^2 \frac{\theta}{2} + \frac{(4\lambda^2 + 1^2)(4\lambda^2 + 3^2)}{2^2 4^2} \sin^4 \frac{\theta}{2} + \dots \quad (0 \leq \theta < \pi)$$

8.12.2  $P_{-\frac{1}{2}+i\lambda}(\cos \theta) = P_{-\frac{1}{2}-i\lambda}(\cos \theta)$

8.12.3  $P_{-\frac{1}{2}+i\lambda}(\cos \theta) = \frac{2}{\pi} \int_0^{\theta} \frac{\cosh \lambda t dt}{\sqrt{2(\cos t - \cos \theta)}}$

8.12.4

$$Q_{-\frac{1}{2}+i\lambda}(\cos \theta) = \pm i \sinh \lambda \pi \int_0^{\infty} \frac{\cos \lambda t dt}{\sqrt{2(\cosh t + \cos \theta)}} + \int_0^{\infty} \frac{\cosh \lambda t dt}{\sqrt{2(\cosh t - \cos \theta)}}$$

8.12.5

$$P_{-\frac{1}{2}+i\lambda}(-\cos \theta) = \frac{\cosh \lambda \pi}{\pi} [Q_{-\frac{1}{2}+i\lambda}(\cos \theta) + Q_{-\frac{1}{2}-i\lambda}(\cos \theta)]$$

\* 8.13. Relation to Elliptic Integrals (see chapter 17) ( $\Re \eta > 0$ )

8.13.1  $P_{-\frac{1}{2}}(z) = \frac{2}{\pi} \sqrt{\frac{2}{z+1}} K\left(\sqrt{\frac{z-1}{z+1}}\right)$

8.13.2  $P_{-\frac{1}{2}}(\cosh \eta) = \left[\frac{\pi \cosh \eta}{2}\right]^{-1} K\left(\tanh \frac{\eta}{2}\right)$

8.13.3  $Q_{-\frac{1}{2}}(z) = \sqrt{\frac{2}{z+1}} K\left(\sqrt{\frac{2}{z+1}}\right)$

8.13.4  $Q_{-\frac{1}{2}}(\cosh \eta) = 2e^{-\eta/2} K(e^{-\eta})$

8.13.5

$$P_{\frac{1}{2}}(z) = \frac{2}{\pi} (z + \sqrt{z^2 - 1})^{1/2} E\left(\sqrt{\frac{2(z^2 - 1)^{1/2}}{z + (z^2 - 1)^{1/2}}}\right)$$

8.13.6  $P_{\frac{1}{2}}(\cosh \eta) = \frac{2}{\pi} e^{\eta/2} E(\sqrt{1 - e^{-2\eta}})$

8.13.7

$$Q_{\frac{1}{2}}(z) = z \sqrt{\frac{2}{z+1}} K\left(\sqrt{\frac{2}{z+1}}\right) - [2(z+1)]^{1/2} E\left(\sqrt{\frac{2}{z+1}}\right) \quad (-1 < x < 1) \quad *$$

8.13.8  $P_{-\frac{1}{2}}(x) = \frac{2}{\pi} K\left(\sqrt{\frac{1-x}{2}}\right)$

8.13.9  $P_{-\frac{1}{2}}(\cos \theta) = \frac{2}{\pi} K\left(\sin \frac{\theta}{2}\right)$

8.13.10  $Q_{-\frac{1}{2}}(x) = K\left(\sqrt{\frac{1+x}{2}}\right) \quad *$

8.13.11  $P_{\frac{1}{2}}(x) = \frac{2}{\pi} \left[ 2E\left(\sqrt{\frac{1-x}{2}}\right) - K\left(\sqrt{\frac{1-x}{2}}\right) \right]$

8.13.12  $Q_{\frac{1}{2}}(x) = K\left(\sqrt{\frac{1+x}{2}}\right) - 2E\left(\sqrt{\frac{1+x}{2}}\right) \quad *$

8.14. Integrals

8.14.1  $\int_1^{\infty} P_{\nu}(x) Q_{\rho}(x) dx = [(\rho - \nu)(\rho + \nu + 1)]^{-1} \quad (\Re \rho > \Re \nu > 0)$

8.14.2  $\int_1^{\infty} Q_{\nu}(x) Q_{\rho}(x) dx = [(\rho - \nu)(\rho + \nu + 1)]^{-1} [\psi(\rho + 1) - \psi(\nu + 1)] \quad (\Re(\rho + \nu) > -1, \rho + \nu + 1 \neq 0; \nu, \rho \neq -1, -2, -3, \dots)$

8.14.3  $\int_1^{\infty} [Q_{\nu}(x)]^2 dx = (2\nu + 1)^{-1} \psi'(\nu + 1) \quad (\Re \nu > -\frac{1}{2})$

8.14.4  $\int_{-1}^1 P_{\nu}(x) P_{\rho}(x) dx = \frac{2}{\pi^2} [(\rho - \nu)(\rho + \nu + 1)]^{-1} \{ 2 \sin \pi \nu \sin \pi \rho [\psi(\nu + 1) - \psi(\rho + 1)] + \pi \sin(\pi \rho - \pi \nu) \} \quad (\rho + \nu + 1 \neq 0)$

8.14.5  $\int_{-1}^1 [P_{\nu}(x)]^2 dx = \frac{\pi^2 - 2(\sin \pi \nu)^2 \psi'(\nu + 1)}{\pi^2(\nu + \frac{1}{2})} \quad *$

8.14.6  $\int_{-1}^1 Q_{\nu}(x) Q_{\rho}(x) dx = [(\rho - \nu)(\rho + \nu + 1)]^{-1} \{ [\psi(\nu + 1) - \psi(\rho + 1)][1 + \cos \rho \pi \cos \nu \pi] - \frac{1}{2} \pi \sin(\nu \pi - \rho \pi) \} \quad (\rho + \nu + 1 \neq 0; \nu, \rho \neq -1, -2, -3, \dots)$

8.14.7  $\int_{-1}^1 [Q_{\nu}(x)]^2 dx = (2\nu + 1)^{-1} \{ \frac{1}{2} \pi^2 - \psi'(\nu + 1) [1 + (\cos \nu \pi)^2] \} \quad (\nu \neq -1, -2, -3, \dots)$

\*See page II.

$$8.14.8 \quad \int_{-1}^1 P_\nu(x) Q_\rho(x) dx = [(\nu - \rho)(\rho + \nu + 1)]^{-1} \left\{ 1 - \cos(\rho\pi - \nu\pi) - \frac{2}{\pi} \sin \pi\nu \cos \pi\nu [\psi(\nu + 1) - \psi(\rho + 1)] \right\}$$

( $\Re \nu > 0, \Re \rho > 0, \rho \neq \nu$ )

$$8.14.9 \quad \int_{-1}^1 P_\nu(x) Q_\nu(x) dx = -\frac{1}{\pi} (2\nu + 1)^{-1} \sin 2\nu\pi \psi'(\nu + 1)$$

( $\Re \nu > 0$ )

( $m, n, l$  positive integers)

8.14.10

$$\int_{-1}^1 Q_n^m(x) P_l^m(x) dx = (-1)^m \frac{1 - (-1)^{l+n} (n+m)!}{(l-n)(l+n+1)(n-m)!}$$

$$8.14.11 \quad \int_{-1}^1 P_n^m(x) P_l^m(x) dx = 0 \quad (l \neq n)$$

$$8.14.12 \quad \int_{-1}^1 P_n^m(x) P_n^l(x) (1-x^2)^{-1} dx = 0 \quad (l \neq m)$$

$$8.14.13 \quad \int_{-1}^1 [P_n^m(x)]^2 dx = (n + \frac{1}{2})^{-1} (n+m)! / (n-m)!$$

8.14.14

$$\int_{-1}^1 (1-x^2)^{-1} [P_n^m(x)]^2 dx = (n+m)! / m(n-m)!$$

8.14.15

$$\int_0^1 P_\nu(x) x^\rho dx = \frac{\pi^{1/2} 2^{-\rho-1} \Gamma(1+\rho)}{\Gamma(1 + \frac{1}{2}\rho - \frac{1}{2}\nu) \Gamma(\frac{1}{2}\rho + \frac{1}{2}\nu + \frac{3}{2})}$$

( $\Re \rho > -1$ )

8.14.16

$$\int_0^\pi (\sin t)^{\alpha-1} P_\nu^{-\mu}(\cos t) dt = \frac{2^{-\mu} \pi \Gamma(\frac{1}{2}\alpha + \frac{1}{2}\mu) \Gamma(\frac{1}{2}\alpha - \frac{1}{2}\mu)}{\Gamma(\frac{1}{2} + \frac{1}{2}\alpha + \frac{1}{2}\nu) \Gamma(\frac{1}{2}\alpha - \frac{1}{2}\nu) \Gamma(\frac{1}{2}\mu + \frac{1}{2}\nu + 1) \Gamma(\frac{1}{2}\mu - \frac{1}{2}\nu + \frac{1}{2})}$$

( $\Re(\alpha \pm \mu) > 0$ )

8.14.17

$$P_\nu^{-m}(z) = (z^2 - 1)^{-1/2 m} \int_1^z \cdots \int_1^z P_\nu(z) (dz)^m$$

8.14.18

$$Q_\nu^{-m}(z) = (-1)^m (z^2 - 1)^{-1/2 m} \int_z^\infty \cdots \int_z^\infty Q_\nu(z) (dz)^m$$

For other integrals, see [8.2], [8.4] and chapter 22.

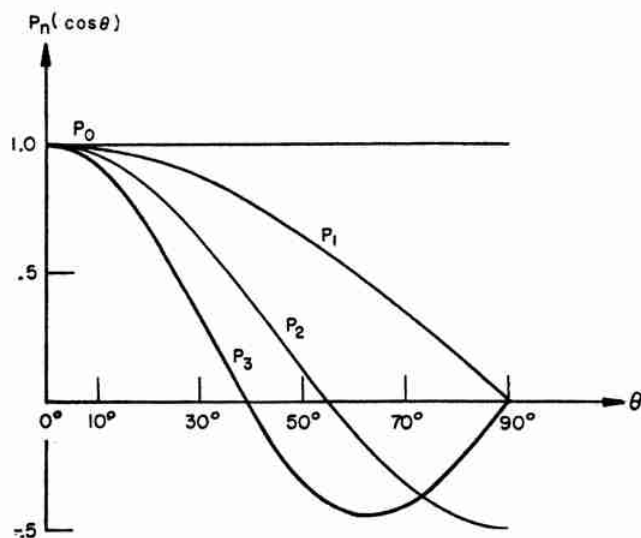
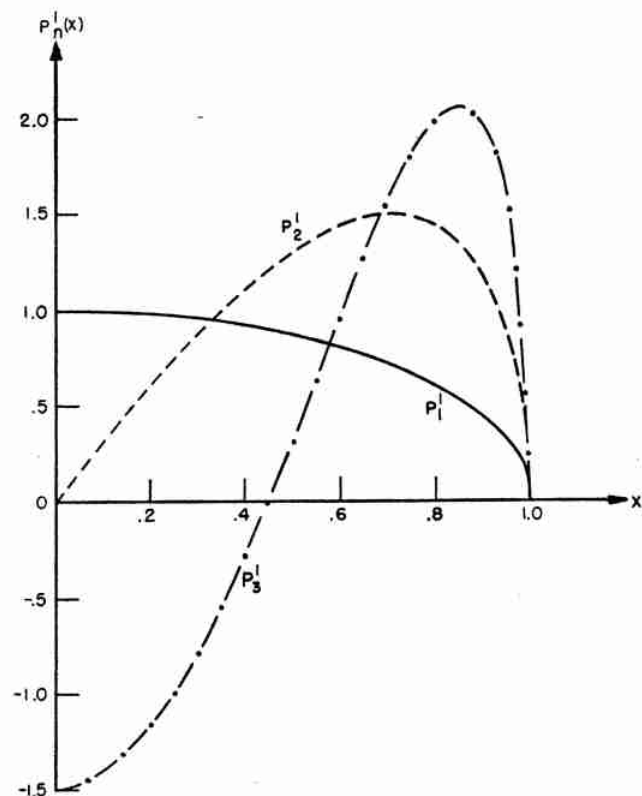
FIGURE 8.1.  $P_n(\cos \theta)$ .  $n=0(1)3$ .FIGURE 8.2.  $P_n^l(x)$ .  $n=1(1)3, x \leq 1$ .

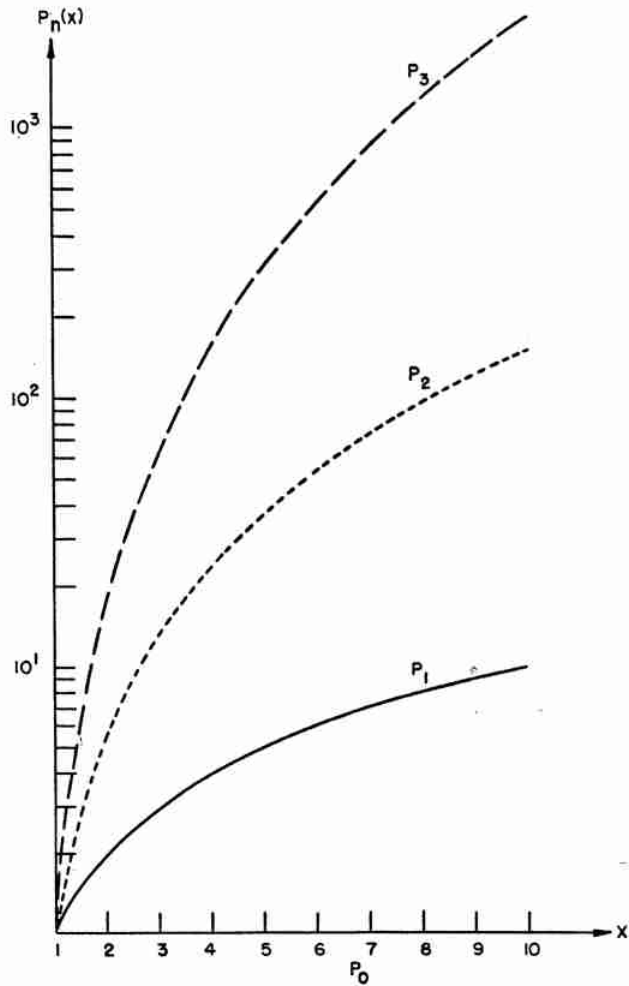

FIGURE 8.3.  $P_n(x)$ .  $n=0(1)3, x \geq 1$ .

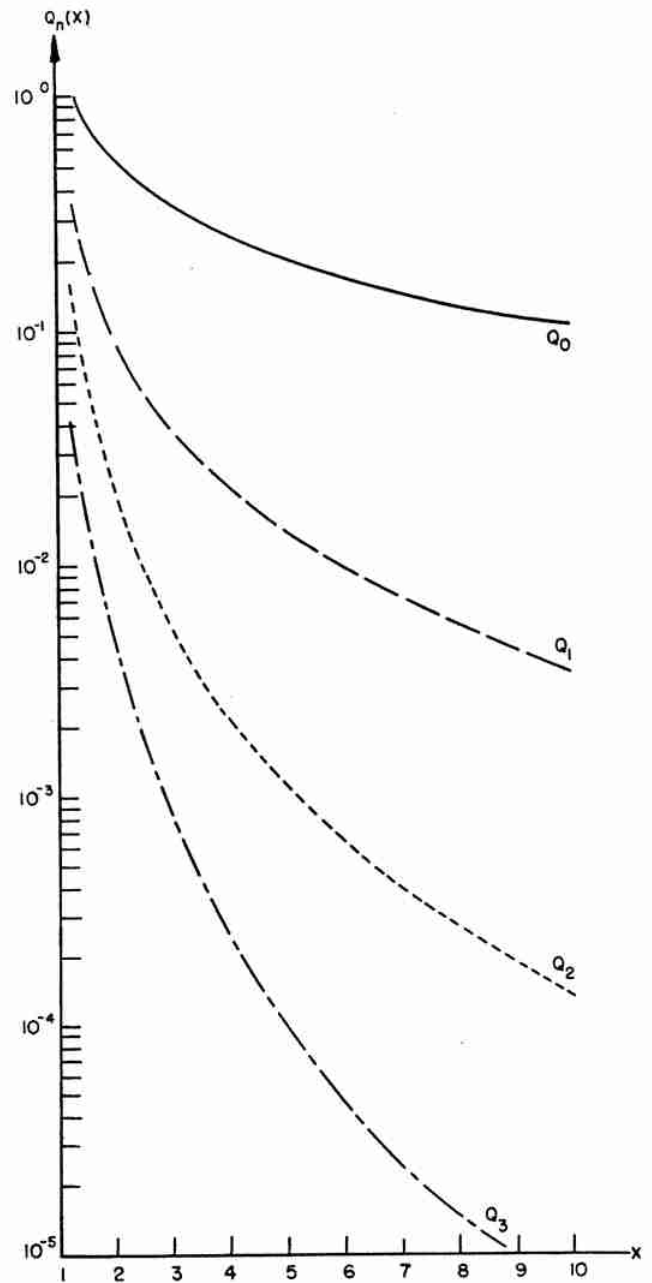

FIGURE 8.5.  $Q_n(x)$ .  $n=0(1)3, x > 1$ .

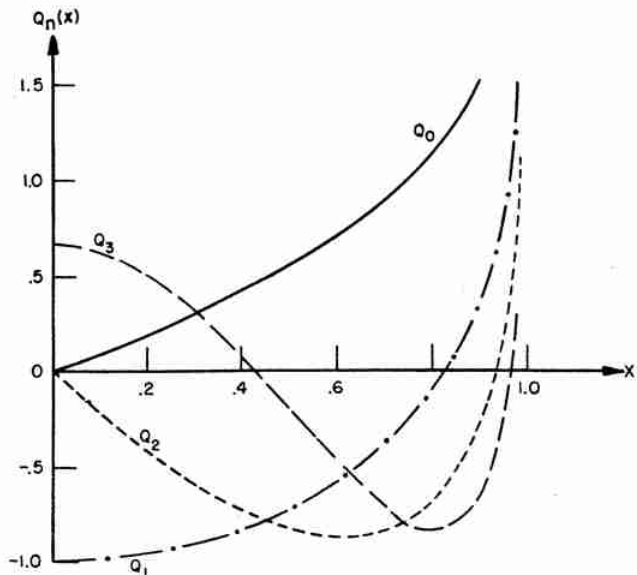

FIGURE 8.4.  $Q_n(x)$ .  $n=0(1)3, x < 1$ .

### Numerical Methods

#### 8.15. Use and Extension of the Tables

##### Computation of $P_n(x)$

For all values of  $x$  there is very little loss of significant figures (except at zeros) in using the recurrence relation 8.5.3 for increasing values of  $n$ .

**Example 1.** Compute  $P_n(x)$  for  $x=.31415\ 92654$  and  $x=2.6$  for  $n=2(1)8$ .

| $n$ | $P_n(.31415\ 92654)$ | $P_n(2.6)$  |
|-----|----------------------|-------------|
| 0   | 1                    | 1           |
| 1   | .31415 92654         | 2.6         |
| 2   | -.35195 59340        | 9.64        |
| 3   | -.39372 32064        | 40.04       |
| 4   | .04750 63122         | 174.952     |
| 5   | .34184 27517         | 786.74336   |
| 6   | .15729 86975         | 3604.350016 |
| 7   | -.20123 39354        | 16729.51005 |
| 8   | -.25617 29328        | 78402.55522 |

Computing  $P_8(x)$  using **Table 22.9** carrying ten significant figures,  $P_8(.31415\ 92654) = -.25617\ 29328$  and  $P_8(2.6) = 78402.55526$ .

#### Computation of $Q_n(x)$

For  $x < 1$ , use of **8.5.3** for increasing values of  $n$  leads to very little loss of significant figures. However, for  $x > 1$ , the recurrence relation **8.5.3** should be used only for decreasing values of  $n$ , after having first obtained  $Q_n$  using the formulas in terms of hypergeometric functions.

**Example 2.** Compute  $Q_n(x)$  for  $x = .31415\ 92654$  and  $n = 0(1)4$ .

With the aid of **8.4.2** and **8.4.4** we obtain

| $n$ | $Q_n(.31415\ 92654)$ |
|-----|----------------------|
| 0   | .32515 34813         |
| 1   | -.89785 00212        |
| 2   | -.58567 85953        |
| 3   | .29190 60854         |
| 4   | .59974 26989         |

Using the results of **Example 1** together with **8.6.19**, we find  $Q_4(x) = \frac{1}{2}P_4(x)\ln\left(\frac{1+x}{1-x}\right) - W_3(x)$  where  $W_3 = \frac{7}{4}P_3 + \frac{1}{3}P_1$ , giving  $Q_4(.31415\ 92654) = .59974\ 26989$ .

#### Texts

- [8.1] A. Erdélyi et al., Higher transcendental functions, vol. 1, ch. 3 (McGraw-Hill Book Co., Inc., New York, N.Y., 1953).
- [8.2] E. W. Hobson, The theory of spherical and ellipsoidal harmonics (Chelsea Publishing Co., New York, N.Y., 1955).
- [8.3] J. Lense, Kugelfunktionen (Akademische Verlagsgesellschaft, Leipzig, Germany, 1950).
- [8.4] T. M. MacRobert, Spherical harmonics, 2d rev. ed. (Dover Publications, Inc., New York, N.Y., 1948).
- [8.5] W. Magnus and F. Oberhettinger, Formulas and theorems for the special functions of mathematical physics (Chelsea Publishing Co., New York, N.Y., 1949).
- [8.6] G. Prasad, A treatise on spherical harmonics and the functions of Bessel and Lamé, Part II (Advanced) (Mahamandal Press, Benares City, India, 1932).

**Example 3.** Compute  $Q_5(x)$  for  $x = 2.6$ .

Ten terms in the series for  $F\left(\frac{\nu+2}{2}, \frac{\nu+1}{2}; \nu+\frac{3}{2}, \frac{1}{z^2}\right)$

of **8.1.3** are necessary to obtain nine significant figures giving  $Q_5(2.6) = 4.8182\ 4468 \times 10^{-5}$ . Using **8.5.3** with increasing values of  $n$  carrying ten significant figures we obtain

| $n$ | $Q_n(2.6)$   |
|-----|--------------|
| 0   | .40546 51081 |
| 1   | .05420 928   |
| 2   | .00868 364   |
| 3   | .00148 95    |
| 4   | .00026 49    |
| 5   | .00004 81    |

where  $Q_0$  and  $Q_1$  are obtained using **8.4.2** and **8.4.4**.

#### Computation of $P_{\pm\frac{1}{2}}(x)$ , $Q_{\pm\frac{1}{2}}(x)$

For all values of  $x$ ,  $P_{\pm\frac{1}{2}}(x)$  and  $Q_{\pm\frac{1}{2}}(x)$  are most easily computed by means of **8.13**.

**Example 4.** Compute  $Q_{-\frac{1}{2}}(x)$  for  $x = 2.6$ .

Using **8.13.3** and interpolating in **Table 17.1** for  $K(.5)$ , we find

$$\begin{aligned} Q_{-\frac{1}{2}}(2.6) &= \sqrt{\frac{2}{x+1}} K\left(\sqrt{\frac{2}{x+1}}\right) \\ &= (.74535\ 59925)(1.90424\ 1417) \\ &= 1.41933\ 7751. \end{aligned}$$

On the other hand, at least nine terms in the expansion of  $F\left(\frac{\nu+2}{2}, \frac{\nu+1}{2}; \nu+\frac{3}{2}, \frac{1}{z^2}\right)$  of **8.1.3** are necessary to obtain comparable accuracy.

## References

- [8.7] L. Robin, Fonctions sphériques de Legendre e fonctions sphéroidales. Tome I, II, III (Gauthier-Villars, Paris, France, 1957).
- [8.8] C. Snow, Hypergeometric and Legendre functions with applications to integral equations of potential theory, NBS Applied Math. Series 19 (U.S. Government Printing Office, Washington, D.C., 1952).
- [8.9] R. C. Thorne, The asymptotic expansion of Legendre functions of large degree and order, Philos. Trans. Roy. Soc. London **249**, 597-620 (1957).

#### Tables

- [8.10] H. Bateman, Some problems in potential theory, Mess. of Math., **617**, 52, 73-75 (1922).  $P_n(\cosh \sigma)$ ,  $Q_n(\cosh \sigma)$ ,  $P'_n(\cosh \sigma)$ ,  $Q'_n(\cosh \sigma)$ ;  $\cosh \sigma = 1.1$ ,  $n = 0(1)20$ , 10D;  $\cosh \sigma = 1.2$ , 2, 3;  $n = 0(1)10$ , exact or 10D.

- [8.11] Centre National d'Études des Télécommunications, Tables des fonctions de Legendre associées. Fonction associée de première espèce  $P_n^m(\cos \theta)$  (Éditions de La Revue d'Optique, Paris, France, 1952).  $n = -\frac{1}{2}(1)10$ ,  $m = 0(1)5$ ,  $\theta = 0^\circ(1^\circ)90^\circ$  (variable number of figures).
- [8.12] Centre National d'Études des Télécommunications, Tables numérique des fonctions associées de Legendre. Fonctions associées de première espèce  $P_n^m(\cos \theta)$  (Éditions de La Revue d'Optique, Paris, France, 1959).  $n = -\frac{1}{2}(1)10$ ,  $m = 0(1)2$ ,  $\theta = 0^\circ(1^\circ)180^\circ$  (variable number of figures).
- [8.13] G. C. Clark and S. W. Churchill, Table of Legendre polynomials  $P_n(\cos \theta)$  for  $n = 0(1)80$  and  $\theta = 0^\circ(1^\circ)180^\circ$ , Engineering Research Institute Publications (Univ. of Michigan Press, Ann Arbor, Mich., 1957).
- [8.14] R. O. Gumprecht and G. M. Sliepcevich, Tables of functions of the first and second partial derivatives of Legendre polynomials (Univ. of Michigan Press, Ann Arbor, Mich., 1951). Values of  $[x\pi_n - (1-x^2)\pi_n'] \cdot 10^4$  and  $\pi_n 10^4$  for  $\gamma = 0^\circ(10^\circ)170^\circ(1^\circ)180^\circ$ ,  $n = 1(1)420$ , 5S.
- [8.15] M. E. Lynam, Table of Legendre functions for complex arguments TG-323, The Johns Hopkins Univ. Applied Physics Laboratory, Baltimore, Md. (1958).
- [8.16] National Bureau of Standards, Tables of associated Legendre functions (Columbia Univ. Press, New York, N.Y., 1945).  $P_n^m(\cos \theta)$ ,  $\frac{d}{d\theta} P_n^m(\cos \theta)$ ,  $n = 1(1)10$ ,  $m(\leq n) = 0(1)4$ ,  $\theta = 0^\circ(1^\circ)90^\circ$ , 6S;
- $P_n^m(x)$ ,  $\frac{d}{dx} P_n^m(x)$ ,  $n = 1(1)10$ ,  $(-1)^m Q_n^m(x)$ ,  $(-1)^{m+1} \frac{d}{dx} Q_n^m(x)$ ,  $n = 0(1)10$ ,  $m(\leq n) = 0(1)4$ ,  $x = 1(.1)10$ , 6S or exact;  $i^{-n} P_n^m(ix)$ ,  $i^{-n} \frac{d}{dx} P_n^m(ix)$ ,  $n = 1(1)10$ ,  $i^{n+2m+1} Q_n^m(ix)$ ,  $i^{n+2m-1} \frac{d}{dx} Q_n^m(ix)$ ,  $n = 0(1)10$ ,  $m(\leq n) = 0(1)4$ ,  $x = 0(.1)10$ , 6S;  $P_{n+\frac{1}{2}}^m(x)$ ,  $\frac{d}{dx} P_{n-\frac{1}{2}}^m(x)$ ,  $(-1)^m Q_{n-\frac{1}{2}}^m(x)$ ,  $(-1)^{m+1} \frac{d}{dx} Q_{n+\frac{1}{2}}^m(x)$ ,  $n = -1(1)4$ ,  $m = 0(1)4$ ,  $x = 1(.1)10$ , 4-6S.
- [8.17] G. Prevost, Tables des fonctions sphériques et de leurs intégrales (Gauthier-Villars, Bordeaux and Paris, France, 1933).  $P_n(x)$ ,  $\int_0^x P_n(t) dt$ ,  $n = 1(1)10$ ;  $P_n^j(x)$ ,  $\int_0^x P_n^j(t) dt$ ,  $n = 0(1)8$ ,  $j = 0(1)n$ ,  $x = 0(.01)1$ , 5S.
- [8.18] H. Tallqvist, Sechstellige Tafeln der 32 ersten Kugelfunktionen  $P_n(\cos \theta)$ , Acta Soc. Sci. Fenn., Nova Series A, II, 11 (1938).  $P_n(\cos \theta)$ ,  $n = 1(1)32$ ,  $0^\circ(10')90^\circ$ ; 6D.
- [8.19] H. Tallqvist, Acta Soc. Sci. Fenn., Nova Series A, II, 4(1937).  $P_n(x)$ ,  $n = 1(1)16$ ,  $x = 0(.001)1$ , 6D.
- [8.20] H. Tallqvist, Tafeln der Kugelfunktionen  $P_{2s}(\cos \theta)$  bis  $P_{32}(\cos \theta)$ , Soc. Sci. Fenn. Comment. Phys.-Math., VI, 10(1932).  $P_n(\cos \theta)$ ,  $n = 25(1)32$ ,  $\theta = 0^\circ(1^\circ)90^\circ$ , 5D.
- [8.21] H. Tallqvist, Tafeln der 24 ersten Kugelfunktionen  $P_n(\cos \theta)$ , Soc. Sci. Fenn. Comment. Phys.-Math., VI, 3(1932).  $P_n(\cos \theta)$ ,  $n = 1(1)24$ ,  $\theta = 0^\circ(1^\circ)90^\circ$ , 5D.





# 9. Bessel Functions of Integer Order

F. W. J. OLVER<sup>1</sup>

## Contents

|  | Page |
|--|------|
| <b>Mathematical Properties</b> . . . . .   | 358  |
| <b>Notation.</b> . . . . .   | 358  |
| <b>Bessel Functions <math>J</math> and <math>Y</math>.</b> . . . . .                     | 358  |
| 9.1. Definitions and Elementary Properties . . . . .                                     | 358  |
| 9.2. Asymptotic Expansions for Large Arguments . . . . .                                 | 364  |
| 9.3. Asymptotic Expansions for Large Orders . . . . .                                    | 365  |
| 9.4. Polynomial Approximations . . . . .   | 369  |
| 9.5. Zeros. . . . .  | 370  |
| <b>Modified Bessel Functions <math>I</math> and <math>K</math>.</b> . . . . .            | 374  |
| 9.6. Definitions and Properties . . . . .  | 374  |
| 9.7. Asymptotic Expansions. . . . .  | 377  |
| 9.8. Polynomial Approximations. . . . .  | 378  |
| <b>Kelvin Functions.</b> . . . . .   | 379  |
| 9.9. Definitions and Properties . . . . .  | 379  |
| 9.10. Asymptotic Expansions . . . . .  | 381  |
| 9.11. Polynomial Approximations . . . . .  | 384  |
| <b>Numerical Methods</b> . . . . .   | 385  |
| 9.12. Use and Extension of the Tables. . . . .   | 385  |
| <b>References.</b> . . . . .   | 388  |
| <b>Table 9.1.</b> Bessel Functions—Orders 0, 1, and 2 ( $0 \leq x \leq 17.5$ ) . . . . . | 390  |
| $J_0(x)$ , 15D, $J_1(x)$ , $J_2(x)$ , $Y_0(x)$ , $Y_1(x)$ , 10D                          |      |
| $Y_2(x)$ , 8D  |      |
| $x=0(.1)17.5$  |      |
| Bessel Functions—Modulus and Phase of Orders 0, 1, 2                                     |      |
| ( $10 \leq x \leq \infty$ ) . . . . .  | 396  |
| $x^{\frac{1}{2}}M_n(x)$ , $\theta_n(x)-x$ , 8D   |      |
| $n=0(1)2$ , $x^{-1}=.1(-.01)0$   |      |
| Bessel Functions—Auxiliary Table for Small Arguments                                     |      |
| ( $0 \leq x \leq 2$ ) . . . . .  | 397  |
| $Y_0(x) - \frac{2}{\pi} J_0(x) \ln x$ , $x[Y_1(x) - \frac{2}{\pi} J_1(x) \ln x]$         |      |
| $x=0(.1)2$ , 8D  |      |
| <b>Table 9.2.</b> Bessel Functions—Orders 3–9 ( $0 \leq x \leq 20$ ) . . . . .           | 398  |
| $J_n(x)$ , $Y_n(x)$ , $n=3(1)9$  |      |
| $x=0(.2)20$ , 5D or 5S   |      |

<sup>1</sup> National Bureau of Standards, on leave from the National Physical Laboratory.

# 9. Bessel Functions of Integer Order

## Mathematical Properties

### Notation

The tables in this chapter are for Bessel functions of integer order; the text treats general orders. The conventions used are:

$$z = x + iy; x, y \text{ real.}$$

$n$  is a positive integer or zero.

$\nu, \mu$  are unrestricted except where otherwise indicated;  $\nu$  is supposed real in the sections devoted to Kelvin functions 9.9, 9.10, and 9.11.

The notation used for the Bessel functions is that of Watson [9.15] and the British Association and Royal Society Mathematical Tables. The function  $Y_\nu(z)$  is often denoted  $N_\nu(z)$  by physicists and European workers.

Other notations are those of:

Aldis, Airey:

$$G_n(z) \text{ for } -\frac{1}{2}\pi Y_n(z), K_n(z) \text{ for } (-)^n K_n(z).$$

Clifford:

$$C_n(x) \text{ for } x^{-1/2} J_n(2\sqrt{x}).$$

Gray, Mathews and MacRobert [9.9]:

$$Y_n(z) \text{ for } \frac{1}{2}\pi Y_n(z) + (\ln 2 - \gamma) J_n(z),$$

$$\bar{Y}_\nu(z) \text{ for } \pi e^{\nu\pi i} \sec(\nu\pi) Y_\nu(z),$$

$$G_\nu(z) \text{ for } \frac{1}{2}\pi i H_\nu^{(1)}(z).$$

Jahnke, Emde and Lösch [9.32]:

$$\Lambda_\nu(z) \text{ for } \Gamma(\nu+1) (\frac{1}{2}z)^{-\nu} J_\nu(z).$$

Jeffreys:

$$Hs_\nu(z) \text{ for } H_\nu^{(1)}(z), Hi_\nu(z) \text{ for } H_\nu^{(2)}(z),$$

$$Kh_\nu(z) \text{ for } (2/\pi) K_\nu(z).$$

Heine:

$$K_n(z) \text{ for } -\frac{1}{2}\pi Y_n(z).$$

Neumann:

$$Y^n(z) \text{ for } \frac{1}{2}\pi Y_n(z) + (\ln 2 - \gamma) J_n(z).$$

Whittaker and Watson [9.18]:

$$K_\nu(z) \text{ for } \cos(\nu\pi) K_\nu(z).$$

### Bessel Functions $J$ and $Y$

#### 9.1. Definitions and Elementary Properties

##### Differential Equation

$$9.1.1 \quad z^2 \frac{d^2 w}{dz^2} + z \frac{dw}{dz} + (z^2 - \nu^2) w = 0$$

Solutions are the Bessel functions of the first kind  $J_{\pm\nu}(z)$ , of the second kind  $Y_\nu(z)$  (also called Weber's function) and of the third kind  $H_\nu^{(1)}(z)$ ,  $H_\nu^{(2)}(z)$  (also called the Hankel functions). Each is a regular (holomorphic) function of  $z$  throughout the  $z$ -plane cut along the negative real axis, and for fixed  $z (\neq 0)$  each is an entire (integral) function of  $\nu$ . When  $\nu = \pm n$ ,  $J_\nu(z)$  has no branch point and is an entire (integral) function of  $z$ .

Important features of the various solutions are as follows:  $J_\nu(z)$  ( $\Re \nu \geq 0$ ) is bounded as  $z \rightarrow 0$  in any bounded range of  $\arg z$ .  $J_\nu(z)$  and  $J_{-\nu}(z)$  are linearly independent except when  $\nu$  is an integer.  $J_\nu(z)$  and  $Y_\nu(z)$  are linearly independent for all values of  $\nu$ .

$H_\nu^{(1)}(z)$  tends to zero as  $|z| \rightarrow \infty$  in the sector  $0 < \arg z < \pi$ ;  $H_\nu^{(2)}(z)$  tends to zero as  $|z| \rightarrow \infty$  in the sector  $-\pi < \arg z < 0$ . For all values of  $\nu$ ,  $H_\nu^{(1)}(z)$  and  $H_\nu^{(2)}(z)$  are linearly independent.

##### Relations Between Solutions

$$9.1.2 \quad Y_\nu(z) = \frac{J_\nu(z) \cos(\nu\pi) - J_{-\nu}(z)}{\sin(\nu\pi)}$$

The right of this equation is replaced by its limiting value if  $\nu$  is an integer or zero.

##### 9.1.3

$$H_\nu^{(1)}(z) = J_\nu(z) + iY_\nu(z) \\ = i \csc(\nu\pi) \{ e^{-\nu\pi i} J_\nu(z) - J_{-\nu}(z) \}$$

##### 9.1.4

$$H_\nu^{(2)}(z) = J_\nu(z) - iY_\nu(z) \\ = i \csc(\nu\pi) \{ J_{-\nu}(z) - e^{\nu\pi i} J_\nu(z) \}$$

$$9.1.5 \quad J_{-n}(z) = (-)^n J_n(z) \quad Y_{-n}(z) = (-)^n Y_n(z)$$

$$9.1.6 \quad H_{-\nu}^{(1)}(z) = e^{\nu\pi i} H_\nu^{(1)}(z) \quad H_{-\nu}^{(2)}(z) = e^{-\nu\pi i} H_\nu^{(2)}(z)$$

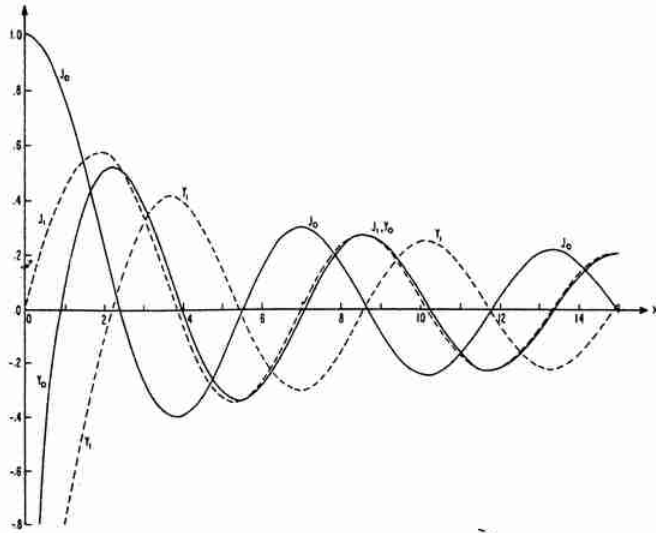

FIGURE 9.1.  $J_0(x)$ ,  $Y_0(x)$ ,  $J_1(x)$ ,  $Y_1(x)$ .

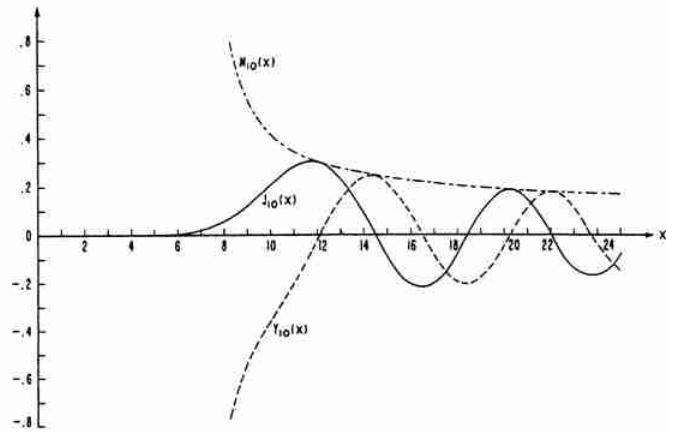

FIGURE 9.2.  $J_{10}(x)$ ,  $Y_{10}(x)$ , and  $M_{10}(x) = \sqrt{J_{10}^2(x) + Y_{10}^2(x)}$ .

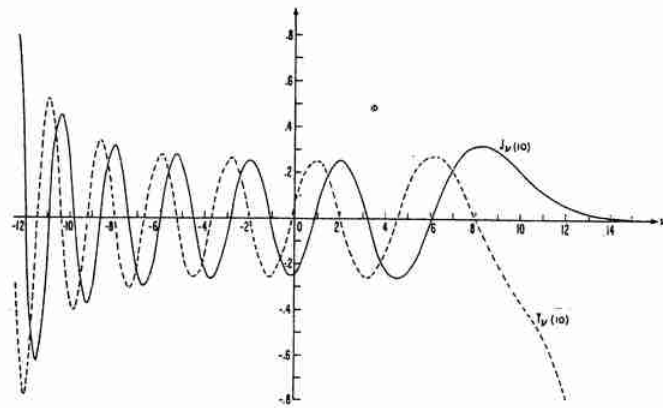

FIGURE 9.3.  $J_{10}(x)$  and  $Y_{10}(x)$ .

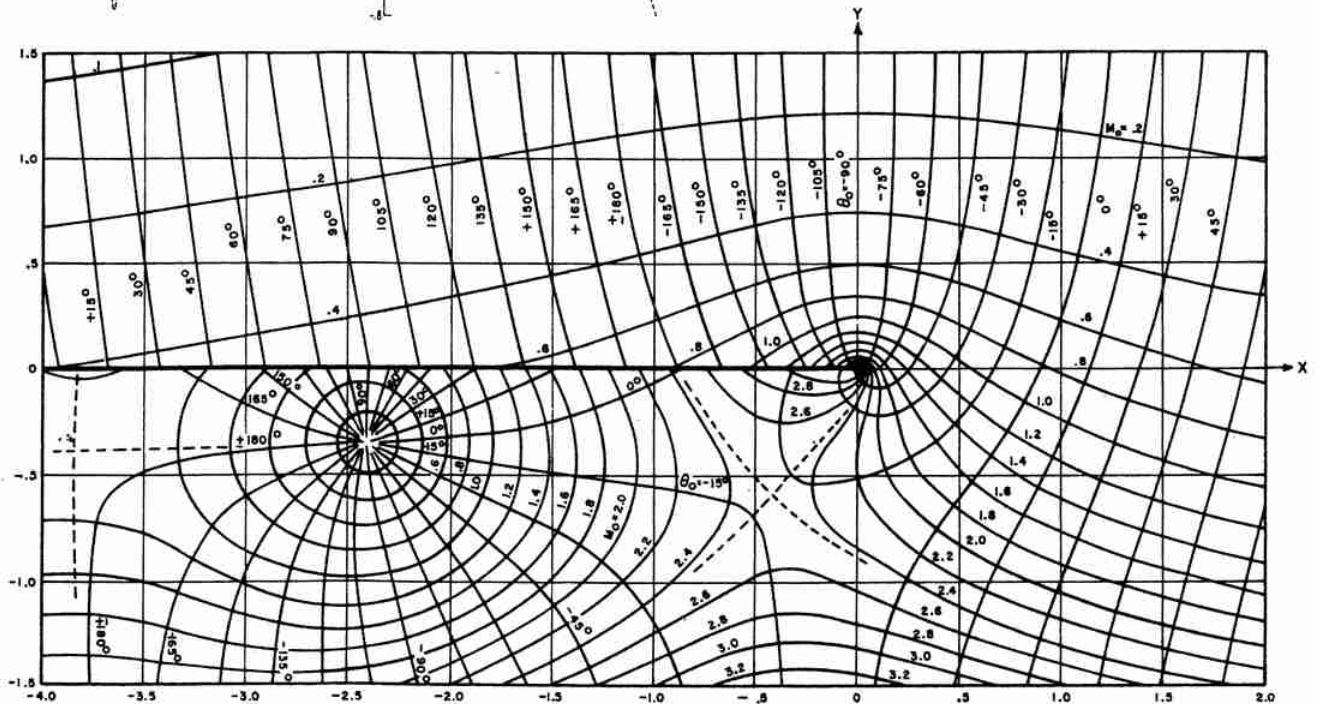

FIGURE 9.4. Contour lines of the modulus and phase of the Hankel Function  $H_0^{(1)}(x+iy) = M_0 e^{i\theta_0}$ . From E. Jahnke, F. Emde, and F. Lösch, Tables of higher functions, McGraw-Hill Book Co., Inc., New York, N.Y., 1960 (with permission).

## Limiting Forms for Small Arguments

When  $\nu$  is fixed and  $z \rightarrow 0$

## 9.1.7

$$J_\nu(z) \sim (\frac{1}{2}z)^\nu / \Gamma(\nu+1) \quad (\nu \neq -1, -2, -3, \dots)$$

$$9.1.8 \quad Y_0(z) \sim -iH_0^{(1)}(z) \sim iH_0^{(2)}(z) \sim (2/\pi) \ln z$$

## 9.1.9

$$Y_\nu(z) \sim -iH_\nu^{(1)}(z) \sim iH_\nu^{(2)}(z) \sim -(1/\pi) \Gamma(\nu) (\frac{1}{2}z)^{-\nu} \quad (\Re \nu > 0)$$

## Ascending Series

$$9.1.10 \quad J_\nu(z) = (\frac{1}{2}z)^\nu \sum_{k=0}^{\infty} \frac{(-\frac{1}{4}z^2)^k}{k! \Gamma(\nu+k+1)}$$

## 9.1.11

$$Y_n(z) = -\frac{(\frac{1}{2}z)^{-n}}{\pi} \sum_{k=0}^{n-1} \frac{(n-k-1)!}{k!} (\frac{1}{4}z^2)^k + \frac{2}{\pi} \ln(\frac{1}{2}z) J_n(z) - \frac{(\frac{1}{2}z)^n}{\pi} \sum_{k=0}^{\infty} \{\psi(k+1) + \psi(n+k+1)\} \frac{(-\frac{1}{4}z^2)^k}{k!(n+k)!}$$

where  $\psi(n)$  is given by 6.3.2.

$$9.1.12 \quad J_0(z) = 1 - \frac{\frac{1}{4}z^2}{(1!)^2} + \frac{(\frac{1}{4}z^2)^2}{(2!)^2} - \frac{(\frac{1}{4}z^2)^3}{(3!)^2} + \dots$$

## 9.1.13

$$Y_0(z) = \frac{2}{\pi} \{ \ln(\frac{1}{2}z) + \gamma \} J_0(z) + \frac{2}{\pi} \left\{ \frac{\frac{1}{4}z^2}{(1!)^2} - (1+\frac{1}{2}) \frac{(\frac{1}{4}z^2)^2}{(2!)^2} + (1+\frac{1}{2}+\frac{1}{3}) \frac{(\frac{1}{4}z^2)^3}{(3!)^2} - \dots \right\}$$

## 9.1.14

$$J_\nu(z) J_\mu(z) = (\frac{1}{2}z)^{\nu+\mu} \sum_{k=0}^{\infty} \frac{(-)^k \Gamma(\nu+\mu+2k+1) (\frac{1}{4}z^2)^k}{\Gamma(\nu+k+1) \Gamma(\mu+k+1) \Gamma(\nu+\mu+k+1) k!}$$

## Wronskians

## 9.1.15

$$W\{J_\nu(z), J_{-\nu}(z)\} = J_{\nu+1}(z) J_{-\nu}(z) + J_\nu(z) J_{-(\nu+1)}(z) = -2 \sin(\nu\pi) / (\pi z)$$

## 9.1.16

$$W\{J_\nu(z), Y_\nu(z)\} = J_{\nu+1}(z) Y_\nu(z) - J_\nu(z) Y_{\nu+1}(z) = 2 / (\pi z)$$

## 9.1.17

$$W\{H_\nu^{(1)}(z), H_\nu^{(2)}(z)\} = H_{\nu+1}^{(1)}(z) H_\nu^{(2)}(z) - H_\nu^{(1)}(z) H_{\nu+1}^{(2)}(z) = -4i / (\pi z)$$

## Integral Representations

## 9.1.18

$$J_0(z) = \frac{1}{\pi} \int_0^\pi \cos(z \sin \theta) d\theta = \frac{1}{\pi} \int_0^\pi \cos(z \cos \theta) d\theta$$

## 9.1.19

$$Y_0(z) = \frac{4}{\pi^2} \int_0^{\frac{1}{2}\pi} \cos(z \cos \theta) \{ \gamma + \ln(2z \sin^2 \theta) \} d\theta$$

## 9.1.20

$$J_\nu(z) = \frac{(\frac{1}{2}z)^\nu}{\pi^{\frac{1}{2}} \Gamma(\nu + \frac{1}{2})} \int_0^\pi \cos(z \cos \theta) \sin^{2\nu} \theta d\theta = \frac{2(\frac{1}{2}z)^\nu}{\pi^{\frac{1}{2}} \Gamma(\nu + \frac{1}{2})} \int_0^1 (1-t^2)^{\nu-1} \cos(zt) dt \quad (\Re \nu > -\frac{1}{2})$$

## 9.1.21

$$J_n(z) = \frac{1}{\pi} \int_0^\pi \cos(z \sin \theta - n\theta) d\theta = \frac{i^{-n}}{\pi} \int_0^\pi e^{iz \cos \theta} \cos(n\theta) d\theta$$

## 9.1.22

$$J_\nu(z) = \frac{1}{\pi} \int_0^\pi \cos(z \sin \theta - \nu\theta) d\theta - \frac{\sin(\nu\pi)}{\pi} \int_0^\infty e^{-z \sinh t - \nu t} dt \quad (|\arg z| < \frac{1}{2}\pi)$$

$$Y_\nu(z) = \frac{1}{\pi} \int_0^\pi \sin(z \sin \theta - \nu\theta) d\theta$$

$$- \frac{1}{\pi} \int_0^\infty \{ e^{\nu t} + e^{-\nu t} \cos(\nu\pi) \} e^{-z \sinh t} dt \quad (|\arg z| < \frac{1}{2}\pi)$$

## 9.1.23

$$J_0(x) = \frac{2}{\pi} \int_0^\infty \sin(x \cosh t) dt \quad (x > 0)$$

$$Y_0(x) = -\frac{2}{\pi} \int_0^\infty \cos(x \cosh t) dt \quad (x > 0)$$

## 9.1.24

$$J_\nu(x) = \frac{2(\frac{1}{2}x)^{-\nu}}{\pi^{\frac{1}{2}} \Gamma(\frac{1}{2}-\nu)} \int_1^\infty \frac{\sin(xt) dt}{(t^2-1)^{\nu+\frac{1}{2}}} \quad (|\Re \nu| < \frac{1}{2}, x > 0)$$

$$Y_\nu(x) = -\frac{2(\frac{1}{2}x)^{-\nu}}{\pi^{\frac{1}{2}} \Gamma(\frac{1}{2}-\nu)} \int_1^\infty \frac{\cos(xt) dt}{(t^2-1)^{\nu+\frac{1}{2}}} \quad (|\Re \nu| < \frac{1}{2}, x > 0)$$

## 9.1.25

$$H_\nu^{(1)}(z) = \frac{1}{\pi i} \int_{-\infty}^{\infty+\pi i} e^{z \sinh t - \nu t} dt \quad (|\arg z| < \frac{1}{2}\pi)$$

$$H_\nu^{(2)}(z) = -\frac{1}{\pi i} \int_{-\infty}^{\infty-\pi i} e^{z \sinh t - \nu t} dt \quad (|\arg z| < \frac{1}{2}\pi)$$

## 9.1.26

$$J_\nu(x) = \frac{1}{2\pi i} \int_{-i\infty}^{i\infty} \frac{\Gamma(-t) (\frac{1}{2}x)^{\nu+2t}}{\Gamma(\nu+t+1)} dt \quad (\Re \nu > 0, x > 0)$$

In the last integral the path of integration must lie to the left of the points  $t=0, 1, 2, \dots$

**Recurrence Relations**

9.1.27

$$\begin{aligned} \mathcal{C}_{\nu-1}(z) + \mathcal{C}_{\nu+1}(z) &= \frac{2\nu}{z} \mathcal{C}_{\nu}(z) \\ \mathcal{C}_{\nu-1}(z) - \mathcal{C}_{\nu+1}(z) &= 2\mathcal{C}'_{\nu}(z) \\ \mathcal{C}'_{\nu}(z) &= \mathcal{C}_{\nu-1}(z) - \frac{\nu}{z} \mathcal{C}_{\nu}(z) \\ \mathcal{C}'_{\nu}(z) &= -\mathcal{C}_{\nu+1}(z) + \frac{\nu}{z} \mathcal{C}_{\nu}(z) \end{aligned}$$

$\mathcal{C}$  denotes  $J, Y, H^{(1)}, H^{(2)}$  or any linear combination of these functions, the coefficients in which are independent of  $z$  and  $\nu$ .

9.1.28  $J'_0(z) = -J_1(z) \quad Y'_0(z) = -Y_1(z)$

If  $f_{\nu}(z) = z^p \mathcal{C}_{\nu}(\lambda z^q)$  where  $p, q, \lambda$  are independent of  $\nu$ , then

9.1.29

$$\begin{aligned} f_{\nu-1}(z) + f_{\nu+1}(z) &= (2\nu/\lambda) z^{-q} f_{\nu}(z) \\ (p + \nu q) f_{\nu-1}(z) + (p - \nu q) f_{\nu+1}(z) &= (2\nu/\lambda) z^{1-q} f'_{\nu}(z) \\ z f'_{\nu}(z) &= \lambda q z^q f_{\nu-1}(z) + (p - \nu q) f_{\nu}(z) \\ z f'_{\nu}(z) &= -\lambda q z^q f_{\nu+1}(z) + (p + \nu q) f_{\nu}(z) \end{aligned}$$

**Formulas for Derivatives**

9.1.30

$$\begin{aligned} \left(\frac{1}{z} \frac{d}{dz}\right)^k \{z^{\nu} \mathcal{C}_{\nu-k}(z)\} &= z^{\nu-k} \mathcal{C}_{\nu-k}(z) \\ \left(\frac{1}{z} \frac{d}{dz}\right)^k \{z^{-\nu} \mathcal{C}_{\nu}(z)\} &= (-1)^k z^{-\nu-k} \mathcal{C}_{\nu+k}(z) \quad (k=0, 1, 2, \dots) \end{aligned}$$

9.1.31

$$\begin{aligned} \mathcal{C}_{\nu}^{(k)}(z) &= \frac{1}{2^k} \left\{ \mathcal{C}_{\nu-k}(z) - \binom{k}{1} \mathcal{C}_{\nu-k+2}(z) \right. \\ &\quad \left. + \binom{k}{2} \mathcal{C}_{\nu-k+4}(z) - \dots + (-1)^k \mathcal{C}_{\nu+k}(z) \right\} \\ &\quad (k=0, 1, 2, \dots) \end{aligned}$$

**Recurrence Relations for Cross-Products**

If

9.1.32

$$\begin{aligned} p_{\nu} &= J_{\nu}(a) Y_{\nu}(b) - J_{\nu}(b) Y_{\nu}(a) \\ q_{\nu} &= J_{\nu}(a) Y'_{\nu}(b) - J'_{\nu}(b) Y_{\nu}(a) \\ r_{\nu} &= J'_{\nu}(a) Y_{\nu}(b) - J_{\nu}(b) Y'_{\nu}(a) \\ s_{\nu} &= J'_{\nu}(a) Y'_{\nu}(b) - J'_{\nu}(b) Y'_{\nu}(a) \end{aligned}$$

then

9.1.33

$$\begin{aligned} p_{\nu+1} - p_{\nu-1} &= -\frac{2\nu}{a} q_{\nu} - \frac{2\nu}{b} r_{\nu} \\ q_{\nu+1} + r_{\nu} &= \frac{\nu}{a} p_{\nu} - \frac{\nu+1}{b} p_{\nu+1} \\ r_{\nu+1} + q_{\nu} &= \frac{\nu}{b} p_{\nu} - \frac{\nu+1}{a} p_{\nu+1} \\ s_{\nu} &= \frac{1}{2} p_{\nu+1} + \frac{1}{2} p_{\nu-1} - \frac{\nu^2}{ab} p_{\nu} \end{aligned}$$

and

9.1.34  $p_{\nu} s_{\nu} - q_{\nu} r_{\nu} = \frac{4}{\pi^2 ab}$

**Analytic Continuation**

In 9.1.35 to 9.1.38,  $m$  is an integer.

9.1.35  $J_{\nu}(ze^{m\pi i}) = e^{m\nu\pi i} J_{\nu}(z)$

9.1.36

$$Y_{\nu}(ze^{m\pi i}) = e^{-m\nu\pi i} Y_{\nu}(z) + 2i \sin(m\nu\pi) \cot(\nu\pi) J_{\nu}(z)$$

9.1.37

$$\begin{aligned} \sin(\nu\pi) H_{\nu}^{(1)}(ze^{m\pi i}) &= -\sin\{(m-1)\nu\pi\} H_{\nu}^{(1)}(z) \\ &\quad - e^{-\nu\pi i} \sin(m\nu\pi) H_{\nu}^{(2)}(z) \end{aligned}$$

9.1.38

$$\begin{aligned} \sin(\nu\pi) H_{\nu}^{(2)}(ze^{m\pi i}) &= \sin\{(m+1)\nu\pi\} H_{\nu}^{(2)}(z) \\ &\quad + e^{\nu\pi i} \sin(m\nu\pi) H_{\nu}^{(1)}(z) \end{aligned}$$

9.1.39

$$\begin{aligned} H_{\nu}^{(1)}(ze^{\pi i}) &= -e^{-\nu\pi i} H_{\nu}^{(2)}(z) \\ H_{\nu}^{(2)}(ze^{-\pi i}) &= -e^{\nu\pi i} H_{\nu}^{(1)}(z) \end{aligned}$$

9.1.40

$$\begin{aligned} J_{\nu}(\bar{z}) &= \overline{J_{\nu}(z)} \quad Y_{\nu}(\bar{z}) = \overline{Y_{\nu}(z)} \\ H_{\nu}^{(1)}(\bar{z}) &= \overline{H_{\nu}^{(2)}(z)} \quad H_{\nu}^{(2)}(\bar{z}) = \overline{H_{\nu}^{(1)}(z)} \quad (\nu \text{ real}) \end{aligned}$$

**Generating Function and Associated Series**

9.1.41  $e^{\frac{1}{2}z(t-1/t)} = \sum_{k=-\infty}^{\infty} t^k J_k(z) \quad (t \neq 0)$

9.1.42  $\cos(z \sin \theta) = J_0(z) + 2 \sum_{k=1}^{\infty} J_{2k}(z) \cos(2k\theta)$

9.1.43  $\sin(z \sin \theta) = 2 \sum_{k=0}^{\infty} J_{2k+1}(z) \sin\{(2k+1)\theta\}$

9.1.44

$$\cos(z \cos \theta) = J_0(z) + 2 \sum_{k=1}^{\infty} (-1)^k J_{2k}(z) \cos(2k\theta)$$

9.1.45

$$\sin(z \cos \theta) = 2 \sum_{k=0}^{\infty} (-1)^k J_{2k+1}(z) \cos\{(2k+1)\theta\}$$

9.1.46  $1 = J_0(z) + 2J_2(z) + 2J_4(z) + 2J_6(z) + \dots$

9.1.47

$$\cos z = J_0(z) - 2J_2(z) + 2J_4(z) - 2J_6(z) + \dots$$

9.1.48  $\sin z = 2J_1(z) - 2J_3(z) + 2J_5(z) - \dots$

Other Differential Equations

9.1.49  $w'' + \left(\lambda^2 - \frac{\nu^2 - \frac{1}{4}}{z^2}\right)w = 0, \quad w = z^{\frac{1}{2}}\mathcal{C}_\nu(\lambda z)$

9.1.50  $w'' + \left(\frac{\lambda^2}{4z} - \frac{\nu^2 - 1}{4z^2}\right)w = 0, \quad w = z^{\frac{1}{2}}\mathcal{C}_\nu(\lambda z^{\frac{1}{2}})$

9.1.51  $w'' + \lambda^2 z^{2p-2}w = 0, \quad w = z^{\frac{1}{2}}\mathcal{C}_{1/p}(2\lambda z^{\frac{1}{2}}/p)$

9.1.52

$w'' - \frac{2\nu-1}{z}w' + \lambda^2 w = 0, \quad w = z^\nu \mathcal{C}_\nu(\lambda z)$

9.1.53

$z^2 w'' + (1-2p)zw' + (\lambda^2 q^2 z^{2q} + p^2 - \nu^2 q^2)w = 0, \quad w = z^p \mathcal{C}_\nu(\lambda z^q)$

9.1.54

$w'' + (\lambda^2 e^{2z} - \nu^2)w = 0, \quad w = \mathcal{C}_\nu(\lambda e^z)$

9.1.55

$z^2(z^2 - \nu^2)w'' + z(z^2 - 3\nu^2)w' + \{(z^2 - \nu^2)^2 - (z^2 + \nu^2)\}w = 0, \quad w = \mathcal{C}'_\nu(z)$

9.1.56

$w^{(2n)} = (-1)^n \lambda^{2n} z^{-n} w, \quad w = z^{\frac{1}{2}} \mathcal{C}_n(2\lambda \alpha z^{\frac{1}{2}})$

where  $\alpha$  is any of the  $2n$  roots of unity.

Differential Equations for Products

In the following  $\vartheta \equiv z \frac{d}{dz}$  and  $\mathcal{C}_\nu(z), \mathcal{D}_\mu(z)$  are any cylinder functions of orders  $\nu, \mu$  respectively.

9.1.57

$\{\vartheta^4 - 2(\nu^2 + \mu^2)\vartheta^2 + (\nu^2 - \mu^2)^2\}w + 4z^2(\vartheta + 1)(\vartheta + 2)w = 0, \quad w = \mathcal{C}_\nu(z)\mathcal{D}_\mu(z)$

9.1.58

$\vartheta(\vartheta^2 - 4\nu^2)w + 4z^2(\vartheta + 1)w = 0, \quad w = \mathcal{C}_\nu(z)\mathcal{D}_\nu(z)$

9.1.59

$z^3 w''' + z(4z^2 + 1 - 4\nu^2)w' + (4\nu^2 - 1)w = 0, \quad w = z \mathcal{C}_\nu(z)\mathcal{D}_\nu(z)$

Upper Bounds

9.1.60  $|J_\nu(x)| \leq 1 \ (\nu \geq 0), |J_\nu(x)| \leq 1/\sqrt{2} \ (\nu \geq 1)$

9.1.61  $0 < J_\nu(\nu) < \frac{2^{\frac{1}{2}}}{3^{\frac{1}{2}}\Gamma(\frac{3}{2})\nu^{\frac{1}{2}}} \ (\nu > 0)$

9.1.62  $|J_\nu(z)| \leq \frac{|\frac{1}{2}z|^\nu e^{|\Im z|}}{\Gamma(\nu+1)} \ (\nu \geq -\frac{1}{2}) \quad *$

9.1.63  $|J_n(nz)| \leq \frac{|z^n \exp\{n\sqrt{(1-z^2)}\}}{|1+\sqrt{(1-z^2)}|^n}$

Derivatives With Respect to Order

9.1.64

$\frac{\partial}{\partial \nu} J_\nu(z) = J_\nu(z) \ln(\frac{1}{2}z) - (\frac{1}{2}z)^\nu \sum_{k=0}^{\infty} (-1)^k \frac{\psi(\nu+k+1)}{\Gamma(\nu+k+1)} \frac{(\frac{1}{4}z^2)^k}{k!}$

9.1.65

$\frac{\partial}{\partial \nu} Y_\nu(z) = \cot(\nu\pi) \left\{ \frac{\partial}{\partial \nu} J_\nu(z) - \pi Y_\nu(z) \right\} - \csc(\nu\pi) \frac{\partial}{\partial \nu} J_{-\nu}(z) - \pi J_\nu(z) \ (\nu \neq 0, \pm 1, \pm 2, \dots)$

9.1.66

$\left[ \frac{\partial}{\partial \nu} J_\nu(z) \right]_{\nu=n} = \frac{\pi}{2} Y_n(z) + \frac{n!(\frac{1}{2}z)^{-n}}{2} \sum_{k=0}^{n-1} \frac{(\frac{1}{2}z)^k J_k(z)}{(n-k)k!}$

9.1.67

$\left[ \frac{\partial}{\partial \nu} Y_\nu(z) \right]_{\nu=n} = -\frac{\pi}{2} J_n(z) + \frac{n!(\frac{1}{2}z)^{-n}}{2} \sum_{k=0}^{n-1} \frac{(\frac{1}{2}z)^k Y_k(z)}{(n-k)k!}$

9.1.68

$\left[ \frac{\partial}{\partial \nu} J_\nu(z) \right]_{\nu=0} = \frac{\pi}{2} Y_0(z), \left[ \frac{\partial}{\partial \nu} Y_\nu(z) \right]_{\nu=0} = -\frac{\pi}{2} J_0(z)$

Expressions in Terms of Hypergeometric Functions

9.1.69

$J_\nu(z) = \frac{(\frac{1}{2}z)^\nu}{\Gamma(\nu+1)} {}_0F_1(\nu+1; -\frac{1}{4}z^2) = \frac{(\frac{1}{2}z)^\nu e^{-iz}}{\Gamma(\nu+1)} M(\nu+\frac{1}{2}, 2\nu+1, 2iz)$

9.1.70

$J_\nu(z) = \frac{(\frac{1}{2}z)^\nu}{\Gamma(\nu+1)} \lim F\left(\lambda, \mu; \nu+1; -\frac{z^2}{4\lambda\mu}\right)$

as  $\lambda, \mu \rightarrow \infty$  through real or complex values;  $z, \nu$  being fixed.

( ${}_0F_1$  is the generalized hypergeometric function. For  $M(a, b, z)$  and  $F(a, b; c; z)$  see chapters 13 and 15.)

Connection With Legendre Functions

If  $\mu$  and  $x$  are fixed and  $\nu \rightarrow \infty$  through real positive values

9.1.71

$\lim \{\nu^\mu P_\nu^{-\mu}\left(\cos \frac{x}{\nu}\right)\} = J_\mu(x) \quad (x > 0)$

\*See page 11.



9.1.72

$$\lim \{ \nu^\mu Q_\nu^{-\mu} \left( \cos \frac{x}{\nu} \right) \} = -\frac{1}{2} \pi Y_\mu(x) \quad (x > 0)$$

For  $P_\nu^{-\mu}$  and  $Q_\nu^{-\mu}$ , see chapter 8.

Continued Fractions

9.1.73

$$\frac{J_\nu(z)}{J_{\nu-1}(z)} = \frac{1}{2\nu z^{-1} - \frac{1}{2(\nu+1)z^{-1} - \frac{1}{2(\nu+2)z^{-1} - \dots}}}$$

$$= \frac{\frac{1}{2}z/\nu}{1 - \frac{\frac{1}{2}z^2/\{\nu(\nu+1)\}}{1 - \frac{\frac{1}{2}z^2/\{(\nu+1)(\nu+2)\}}{1 - \dots}}}$$

Multiplication Theorem

9.1.74

$$\mathcal{C}_\nu(\lambda z) = \lambda^{\pm \nu} \sum_{k=0}^{\infty} \frac{(\mp)^k (\lambda^2 - 1)^k (\frac{1}{2}z)^k}{k!} \mathcal{C}_{\nu \pm k}(z)$$

( $|\lambda^2 - 1| < 1$ )

If  $\mathcal{C} = J$  and the upper signs are taken, the restriction on  $\lambda$  is unnecessary.

This theorem will furnish expansions of  $\mathcal{C}_\nu(re^{i\theta})$  in terms of  $\mathcal{C}_{\nu \pm k}(r)$ .

Addition Theorems

Neumann's

9.1.75  $\mathcal{C}_\nu(u \pm v) = \sum_{k=-\infty}^{\infty} \mathcal{C}_{\nu \mp k}(u) J_k(v) \quad (|v| < |u|)$

The restriction  $|v| < |u|$  is unnecessary when  $\mathcal{C} = J$  and  $\nu$  is an integer or zero. Special cases are

9.1.76  $1 = J_0^2(z) + 2 \sum_{k=1}^{\infty} J_k^2(z)$

9.1.77

$$0 = \sum_{k=0}^{2n} (-)^k J_k(z) J_{2n-k}(z) + 2 \sum_{k=1}^{\infty} J_k(z) J_{2n+k}(z) \quad (n \geq 1)$$

9.1.78

$$J_n(2z) = \sum_{k=0}^n J_k(z) J_{n-k}(z) + 2 \sum_{k=1}^{\infty} (-)^k J_k(z) J_{n+k}(z)$$

Graf's

9.1.79

$$\mathcal{C}_\nu(w) \frac{\cos \nu \chi}{\sin \nu \chi} = \sum_{k=-\infty}^{\infty} \mathcal{C}_{\nu+k}(u) J_k(v) \frac{\cos k\alpha}{\sin k\alpha} \quad (|ve^{\pm i\alpha}| < |u|)$$

Gegenbauer's

9.1.80

$$\frac{\mathcal{C}_\nu(w)}{w^\nu} = 2^\nu \Gamma(\nu) \sum_{k=0}^{\infty} (\nu+k) \frac{\mathcal{C}_{\nu+k}(u)}{u^\nu} \frac{J_{\nu+k}(v)}{v^\nu} C_k^{(\nu)}(\cos \alpha)$$

( $\nu \neq 0, -1, \dots, |ve^{\pm i\alpha}| < |u|$ )

In 9.1.79 and 9.1.80,

$$w = \sqrt{(u^2 + v^2 - 2uv \cos \alpha)},$$

$$u - v \cos \alpha = w \cos \chi, \quad v \sin \alpha = w \sin \chi$$

the branches being chosen so that  $w \rightarrow u$  and  $\chi \rightarrow 0$  as  $v \rightarrow 0$ .  $C_k^{(\nu)}(\cos \alpha)$  is Gegenbauer's polynomial (see chapter 22).

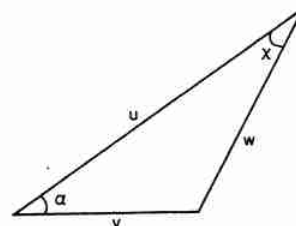

Gegenbauer's addition theorem.

If  $u, v$  are real and positive and  $0 \leq \alpha \leq \pi$ , then  $w, \chi$  are real and non-negative, and the geometrical relationship of the variables is shown in the diagram.

The restrictions  $|ve^{\pm i\alpha}| < |u|$  are unnecessary in 9.1.79 when  $\mathcal{C} = J$  and  $\nu$  is an integer or zero, and in 9.1.80 when  $\mathcal{C} = J$ .

Degenerate Form ( $u = \infty$ ):

9.1.81

$$e^{i\nu \cos \alpha} = \Gamma(\nu) \left(\frac{1}{2}\nu\right)^{-\nu} \sum_{k=0}^{\infty} (\nu+k) i^k J_{\nu+k}(v) C_k^{(\nu)}(\cos \alpha)$$

( $\nu \neq 0, -1, \dots$ )

Neumann's Expansion of an Arbitrary Function in a Series of Bessel Functions

9.1.82  $f(z) = a_0 J_0(z) + 2 \sum_{k=1}^{\infty} a_k J_k(z) \quad (|z| < c)$

where  $c$  is the distance of the nearest singularity of  $f(z)$  from  $z=0$ ,

9.1.83  $a_k = \frac{1}{2\pi i} \int_{|z|=c'} f(t) O_k(t) dt \quad (0 < c' < c)$

and  $O_k(t)$  is Neumann's polynomial. The latter is defined by the generating function

9.1.84

$$\frac{1}{t-z} = J_0(z) O_0(t) + 2 \sum_{k=1}^{\infty} J_k(z) O_k(t) \quad (|z| < |t|)$$

$O_n(t)$  is a polynomial of degree  $n+1$  in  $1/t$ ;  $O_0(t) = 1/t$ ,

9.1.85

$$O_n(t) = \frac{1}{4} \sum_{k=0}^{2n} \frac{n(n-k-1)!}{k!} \left(\frac{2}{t}\right)^{n-2k+1} \quad (n=1, 2, \dots)$$

The more general form of expansion

9.1.86  $f(z) = a_0 J_\nu(z) + 2 \sum_{k=1}^{\infty} a_k J_{\nu+k}(z)$

also called a Neumann expansion, is investigated in [9.7] and [9.15] together with further generalizations. Examples of Neumann expansions are 9.1.41 to 9.1.48 and the Addition Theorems. Other examples are

## 9.1.87

$$\left(\frac{1}{2}z\right)^\nu = \sum_{k=0}^{\infty} \frac{(\nu+2k)\Gamma(\nu+k)}{k!} J_{\nu+2k}(z) \quad (\nu \neq 0, -1, -2, \dots)$$

## 9.1.88

$$Y_n(z) = -\frac{n!(\frac{1}{2}z)^{-n}}{\pi} \sum_{k=0}^{n-1} \frac{(\frac{1}{2}z)^k J_k(z)}{(n-k)k!} + \frac{2}{\pi} \left\{ \ln\left(\frac{1}{2}z\right) - \psi(n+1) \right\} J_n(z) - \frac{2}{\pi} \sum_{k=1}^{\infty} (-)^k \frac{(n+2k)J_{n+2k}(z)}{k(n+k)}$$

where  $\psi(n)$  is given by 6.3.2.

## 9.1.89

$$Y_0(z) = \frac{2}{\pi} \left\{ \ln\left(\frac{1}{2}z\right) + \gamma \right\} J_0(z) - \frac{4}{\pi} \sum_{k=1}^{\infty} (-)^k \frac{J_{2k}(z)}{k}$$

## 9.2. Asymptotic Expansions for Large Arguments

### Principal Asymptotic Forms

When  $\nu$  is fixed and  $|z| \rightarrow \infty$

## 9.2.1

$$J_\nu(z) = \sqrt{2/(\pi z)} \left\{ \cos\left(z - \frac{1}{2}\nu\pi - \frac{1}{4}\pi\right) + e^{i\mathcal{J}z} O(|z|^{-1}) \right\} \quad (|\arg z| < \pi)$$

## 9.2.2

$$Y_\nu(z) = \sqrt{2/(\pi z)} \left\{ \sin\left(z - \frac{1}{2}\nu\pi - \frac{1}{4}\pi\right) + e^{i\mathcal{J}z} O(|z|^{-1}) \right\} \quad (|\arg z| < \pi)$$

## 9.2.3

$$H_\nu^{(1)}(z) \sim \sqrt{2/(\pi z)} e^{i(z - \frac{1}{2}\nu\pi - \frac{1}{4}\pi)} \quad (-\pi < \arg z < 2\pi)$$

## 9.2.4

$$H_\nu^{(2)}(z) \sim \sqrt{2/(\pi z)} e^{-i(z - \frac{1}{2}\nu\pi - \frac{1}{4}\pi)} \quad (-2\pi < \arg z < \pi)$$

### Hankel's Asymptotic Expansions

When  $\nu$  is fixed and  $|z| \rightarrow \infty$

## 9.2.5

$$J_\nu(z) = \sqrt{2/(\pi z)} \{ P(\nu, z) \cos \chi - Q(\nu, z) \sin \chi \} \quad (|\arg z| < \pi)$$

## 9.2.6

$$Y_\nu(z) = \sqrt{2/(\pi z)} \{ P(\nu, z) \sin \chi + Q(\nu, z) \cos \chi \} \quad (|\arg z| < \pi)$$

## 9.2.7

$$H_\nu^{(1)}(z) = \sqrt{2/(\pi z)} \{ P(\nu, z) + iQ(\nu, z) \} e^{i\chi} \quad (-\pi < \arg z < 2\pi)$$

## 9.2.8

$$H_\nu^{(2)}(z) = \sqrt{2/(\pi z)} \{ P(\nu, z) - iQ(\nu, z) \} e^{-i\chi} \quad (-2\pi < \arg z < \pi)$$

where  $\chi = z - (\frac{1}{2}\nu + \frac{1}{4})\pi$  and, with  $4\nu^2$  denoted by  $\mu$ ,

## 9.2.9

$$P(\nu, z) \sim \sum_{k=0}^{\infty} (-)^k \frac{(\nu, 2k)}{(2z)^{2k}} = 1 - \frac{(\mu-1)(\mu-9)}{2!(8z)^2} + \frac{(\mu-1)(\mu-9)(\mu-25)(\mu-49)}{4!(8z)^4} - \dots$$

## 9.2.10

$$Q(\nu, z) \sim \sum_{k=0}^{\infty} (-)^k \frac{(\nu, 2k+1)}{(2z)^{2k+1}} = \frac{\mu-1}{8z} - \frac{(\mu-1)(\mu-9)(\mu-25)}{3!(8z)^3} + \dots$$

If  $\nu$  is real and non-negative and  $z$  is positive, the remainder after  $k$  terms in the expansion of  $P(\nu, z)$  does not exceed the  $(k+1)$ th term in absolute value and is of the same sign, provided that  $k > \frac{1}{2}\nu - \frac{1}{4}$ . The same is true of  $Q(\nu, z)$  provided that  $k > \frac{1}{2}\nu - \frac{3}{4}$ .

### Asymptotic Expansions of Derivatives

With the conditions and notation of the preceding subsection

## 9.2.11

$$J'_\nu(z) = \sqrt{2/(\pi z)} \{ -R(\nu, z) \sin \chi - S(\nu, z) \cos \chi \} \quad (|\arg z| < \pi)$$

## 9.2.12

$$Y'_\nu(z) = \sqrt{2/(\pi z)} \{ R(\nu, z) \cos \chi - S(\nu, z) \sin \chi \} \quad (|\arg z| < \pi)$$

## 9.2.13

$$H_\nu^{(1)'}(z) = \sqrt{2/(\pi z)} \{ iR(\nu, z) - S(\nu, z) \} e^{i\chi} \quad (-\pi < \arg z < 2\pi)$$

## 9.2.14

$$H_\nu^{(2)'}(z) = \sqrt{2/(\pi z)} \{ -iR(\nu, z) - S(\nu, z) \} e^{-i\chi} \quad (-2\pi < \arg z < \pi)$$

9.2.15

$$R(\nu, z) \sim \sum_{k=0}^{\infty} (-)^k \frac{4\nu^2 + 16k^2 - 1}{4\nu^2 - (4k-1)^2} \frac{(\nu, 2k)}{(2z)^{2k}}$$

$$= 1 - \frac{(\mu-1)(\mu+15)}{2!(8z)^2} + \dots$$

9.2.16

$$S(\nu, z) \sim \sum_{k=0}^{\infty} (-)^k \frac{4\nu^2 + 4(2k+1)^2 - 1}{4\nu^2 - (4k+1)^2} \frac{(\nu, 2k+1)}{(2z)^{2k+1}}$$

$$= \frac{\mu+3}{8z} - \frac{(\mu-1)(\mu-9)(\mu+35)}{3!(8z)^3} + \dots$$

Modulus and Phase

For real  $\nu$  and positive  $x$

9.2.17

$$M_\nu = |H_\nu^{(1)}(x)| = \sqrt{\{J_\nu^2(x) + Y_\nu^2(x)\}}$$

$$\theta_\nu = \arg H_\nu^{(1)}(x) = \arctan \{Y_\nu(x)/J_\nu(x)\}$$

9.2.18

$$N_\nu = |H_\nu^{(1)'}(x)| = \sqrt{\{J_\nu'^2(x) + Y_\nu'^2(x)\}}$$

$$\varphi_\nu = \arg H_\nu^{(1)'}(x) = \arctan \{Y_\nu'(x)/J_\nu'(x)\}$$

9.2.19  $J_\nu(x) = M_\nu \cos \theta_\nu, \quad Y_\nu(x) = M_\nu \sin \theta_\nu,$

9.2.20  $J_\nu'(x) = N_\nu \cos \varphi_\nu, \quad Y_\nu'(x) = N_\nu \sin \varphi_\nu.$

In the following relations, primes denote differentiations with respect to  $x$ .

9.2.21  $M_\nu^2 \theta_\nu' = 2/(\pi x) \quad N_\nu^2 \varphi_\nu' = 2(x^2 - \nu^2)/(\pi x^3)$

9.2.22  $N_\nu^2 = M_\nu'^2 + M_\nu^2 \theta_\nu'^2 = M_\nu'^2 + 4/(\pi x M_\nu)^2$

9.2.23  $(x^2 - \nu^2)M_\nu M_\nu' + x^2 N_\nu N_\nu' + x N_\nu^2 = 0$

9.2.24

$$\tan(\varphi_\nu - \theta_\nu) = M_\nu \theta_\nu' / M_\nu' = 2/(\pi x M_\nu M_\nu')$$

$$M_\nu N_\nu \sin(\varphi_\nu - \theta_\nu) = 2/(\pi x)$$

9.2.25  $x^2 M_\nu'' + x M_\nu' + (x^2 - \nu^2)M_\nu - 4/(\pi^2 M_\nu^3) = 0$

9.2.26

$x^2 w'' + x(4x^2 + 1 - 4\nu^2)w' + (4\nu^2 - 1)w = 0, \quad w = xM_\nu^2$

9.2.27  $\theta_\nu'^2 + \frac{1}{2} \frac{\theta_\nu'''}{\theta_\nu'} - \frac{3}{4} \left(\frac{\theta_\nu''}{\theta_\nu'}\right)^2 = 1 - \frac{\nu^2 - \frac{1}{4}}{x^2}$

Asymptotic Expansions of Modulus and Phase

When  $\nu$  is fixed,  $x$  is large and positive, and  $\mu = 4\nu^2$

9.2.28

$$M_\nu^2 \sim \frac{2}{\pi x} \left\{ 1 + \frac{1}{2} \frac{\mu-1}{(2x)^2} + \frac{1 \cdot 3}{2 \cdot 4} \frac{(\mu-1)(\mu-9)}{(2x)^4} \right.$$

$$\left. + \frac{1 \cdot 3 \cdot 5}{2 \cdot 4 \cdot 6} \frac{(\mu-1)(\mu-9)(\mu-25)}{(2x)^6} + \dots \right\}$$

9.2.29

$$\theta_\nu \sim x - \left(\frac{1}{2}\nu + \frac{1}{4}\right)\pi + \frac{\mu-1}{2(4x)}$$

$$+ \frac{(\mu-1)(\mu-25)}{6(4x)^3} + \frac{(\mu-1)(\mu^2-114\mu+1073)}{5(4x)^5}$$

$$+ \frac{(\mu-1)(5\mu^3-1535\mu^2+54703\mu-375733)}{14(4x)^7} + \dots$$

9.2.30

$$N_\nu^2 \sim \frac{2}{\pi x} \left\{ 1 - \frac{1}{2} \frac{\mu-3}{(2x)^2} - \frac{1 \cdot 1}{2 \cdot 4} \frac{(\mu-1)(\mu-45)}{(2x)^4} - \dots \right\}$$

The general term in the last expansion is given by

$$\frac{1 \cdot 1 \cdot 3 \dots (2k-3)}{2 \cdot 4 \cdot 6 \dots (2k)}$$

$$\times \frac{(\mu-1)(\mu-9) \dots \{\mu - (2k-3)^2\} \{\mu - (2k+1)(2k-1)^2\}}{(2x)^{2k}}$$

9.2.31

$$\phi_\nu \sim x - \left(\frac{1}{2}\nu - \frac{1}{4}\right)\pi + \frac{\mu+3}{2(4x)} + \frac{\mu^2+46\mu-63}{6(4x)^3}$$

$$+ \frac{\mu^3+185\mu^2-2053\mu+1899}{5(4x)^5} + \dots$$

If  $\nu \geq 0$ , the remainder after  $k$  terms in 9.2.28 does not exceed the  $(k+1)$ th term in absolute value and is of the same sign, provided that  $k > \nu - \frac{1}{2}$ .

9.3. Asymptotic Expansions for Large Orders

Principal Asymptotic Forms

In the following equations it is supposed that  $\nu \rightarrow \infty$  through real positive values, the other variables being fixed.

9.3.1

$$J_\nu(z) \sim \frac{1}{\sqrt{2\pi\nu}} \left(\frac{ez}{2\nu}\right)^\nu$$

$$Y_\nu(z) \sim -\sqrt{\frac{2}{\pi\nu}} \left(\frac{ez}{2\nu}\right)^{-\nu}$$

9.3.2

$$J_\nu(\nu \operatorname{sech} \alpha) \sim \frac{e^{\nu(\tanh \alpha - \alpha)}}{\sqrt{2\pi\nu \tanh \alpha}} \quad (\alpha > 0)$$

$$Y_\nu(\nu \operatorname{sech} \alpha) \sim -\frac{e^{\nu(\alpha - \tanh \alpha)}}{\sqrt{\frac{1}{2}\pi\nu \tanh \alpha}} \quad (\alpha > 0)$$

\*See page II.

## 9.3.3

$$J_\nu(\nu \sec \beta) = \sqrt{2/(\pi\nu \tan \beta)} \left\{ \cos(\nu \tan \beta - \nu\beta - \frac{1}{4}\pi) + O(\nu^{-1}) \right\} \\ (0 < \beta < \frac{1}{2}\pi)$$

$$Y_\nu(\nu \sec \beta) = \sqrt{2/(\pi\nu \tan \beta)} \left\{ \sin(\nu \tan \beta - \nu\beta - \frac{1}{4}\pi) + O(\nu^{-1}) \right\} \\ (0 < \beta < \frac{1}{2}\pi)$$

## 9.3.4

$$J_\nu(\nu + z\nu^{3/2}) = 2^{1/2}\nu^{-1/2} \text{Ai}(-2^{1/2}z) + O(\nu^{-1})$$

$$Y_\nu(\nu + z\nu^{3/2}) = -2^{1/2}\nu^{-1/2} \text{Bi}(-2^{1/2}z) + O(\nu^{-1})$$

## 9.3.5

$$J_\nu(\nu) \sim \frac{2^{1/2}}{3^{3/2}\Gamma(\frac{2}{3})} \frac{1}{\nu^{1/2}}$$

$$Y_\nu(\nu) \sim -\frac{2^{1/2}}{3^{1/2}\Gamma(\frac{2}{3})} \frac{1}{\nu^{1/2}}$$

## 9.3.6

$$J_\nu(\nu z) = \left( \frac{4\zeta}{1-z^2} \right)^{1/4} \left\{ \frac{\text{Ai}(\nu^{3/2}\zeta)}{\nu^{1/2}} + \frac{\exp(-\frac{2}{3}\nu\zeta^{3/2})}{1+\nu^{1/2}|\zeta|^{1/2}} O\left(\frac{1}{\nu^{1/2}}\right) \right\} \quad (|\arg z| < \pi)$$

$$Y_\nu(\nu z) = -\left( \frac{4\zeta}{1-z^2} \right)^{1/4} \left\{ \frac{\text{Bi}(\nu^{3/2}\zeta)}{\nu^{1/2}} + \frac{\exp|\Re(\frac{2}{3}\nu\zeta^{3/2})|}{1+\nu^{1/2}|\zeta|^{1/2}} O\left(\frac{1}{\nu^{1/2}}\right) \right\} \quad (|\arg z| < \pi)$$

In the last two equations  $\zeta$  is given by 9.3.38 and 9.3.39 below.

## Debye's Asymptotic Expansions

(i) If  $\alpha$  is fixed and positive and  $\nu$  is large and positive

## 9.3.7

$$J_\nu(\nu \operatorname{sech} \alpha) \sim \frac{e^{\nu(\tanh \alpha - \alpha)}}{\sqrt{2\pi\nu \tanh \alpha}} \left\{ 1 + \sum_{k=1}^{\infty} \frac{u_k(\coth \alpha)}{\nu^k} \right\}$$

## 9.3.8

$$Y_\nu(\nu \operatorname{sech} \alpha) \sim \frac{e^{\nu(\alpha - \tanh \alpha)}}{\sqrt{\frac{1}{2}\pi\nu \tanh \alpha}} \left\{ 1 + \sum_{k=1}^{\infty} (-)^k \frac{u_k(\coth \alpha)}{\nu^k} \right\}$$

where

## 9.3.9

$$u_0(t) = 1 \\ u_1(t) = (3t - 5t^3)/24 \\ u_2(t) = (81t^2 - 462t^4 + 385t^6)/1152 \\ u_3(t) = (30375t^3 - 3\ 69603t^5 + 7\ 65765t^7 - 4\ 25425t^9)/4\ 14720 \\ u_4(t) = (44\ 65125t^4 - 941\ 21676t^6 + 3499\ 22430t^8 - 4461\ 85740t^{10} + 1859\ 10725t^{12})/398\ 13120$$

For  $u_5(t)$  and  $u_6(t)$  see [9.4] or [9.21].

## 9.3.10

$$u_{k+1}(t) = \frac{1}{2}t^2(1-t^2)u'_k(t) + \frac{1}{8} \int_0^t (1-5t^2)u_k(t)dt \\ (k=0, 1, \dots)$$

Also

## 9.3.11

$$J'_\nu(\nu \operatorname{sech} \alpha) \sim \sqrt{\frac{\sinh 2\alpha}{4\pi\nu}} e^{\nu(\tanh \alpha - \alpha)} \left\{ 1 + \sum_{k=1}^{\infty} \frac{v_k(\coth \alpha)}{\nu^k} \right\}$$

## 9.3.12

$$Y'_\nu(\nu \operatorname{sech} \alpha) \sim \sqrt{\frac{\sinh 2\alpha}{\pi\nu}} e^{\nu(\alpha - \tanh \alpha)} \left\{ 1 + \sum_{k=1}^{\infty} (-)^k \frac{v_k(\coth \alpha)}{\nu^k} \right\}$$

where

## 9.3.13

$$v_0(t) = 1 \\ v_1(t) = (-9t + 7t^3)/24 \\ v_2(t) = (-135t^2 + 594t^4 - 455t^6)/1152 \\ v_3(t) = (-42525t^3 + 4\ 51737t^5 - 8\ 83575t^7 + 4\ 75475t^9)/4\ 14720$$

## 9.3.14

$$v_k(t) = u_k(t) + t(t^2 - 1) \left\{ \frac{1}{2}u_{k-1}(t) + tu'_{k-1}(t) \right\} \\ (k=1, 2, \dots)$$

(ii) If  $\beta$  is fixed,  $0 < \beta < \frac{1}{2}\pi$  and  $\nu$  is large and positive

## 9.3.15

$$J_\nu(\nu \sec \beta) = \sqrt{2/(\pi\nu \tan \beta)} \left\{ L(\nu, \beta) \cos \Psi + M(\nu, \beta) \sin \Psi \right\}$$

## 9.3.16

$$Y_\nu(\nu \sec \beta) = \sqrt{2/(\pi\nu \tan \beta)} \left\{ L(\nu, \beta) \sin \Psi - M(\nu, \beta) \cos \Psi \right\}$$

where  $\Psi = \nu(\tan \beta - \beta) - \frac{1}{4}\pi$

## 9.3.17

$$L(\nu, \beta) \sim \sum_{k=0}^{\infty} \frac{u_{2k}(i \cot \beta)}{\nu^{2k}} \\ = 1 - \frac{81 \cot^2 \beta + 462 \cot^4 \beta + 385 \cot^6 \beta}{1152\nu^2} + \dots$$

9.3.18

$$M(\nu, \beta) \sim -i \sum_{k=0}^{\infty} \frac{u_{2k+1}(i \cot \beta)}{\nu^{2k+1}} \\ = \frac{3 \cot \beta + 5 \cot^3 \beta}{24\nu} \dots$$

Also

9.3.19

$$J'_\nu(\nu \sec \beta) = \sqrt{(\sin 2\beta)/(\pi\nu)} \{ -N(\nu, \beta) \sin \Psi \\ - O(\nu, \beta) \cos \Psi \}$$

9.3.20

$$Y'_\nu(\nu \sec \beta) = \sqrt{(\sin 2\beta)/(\pi\nu)} \{ N(\nu, \beta) \cos \Psi \\ - O(\nu, \beta) \sin \Psi \}$$

where

9.3.21

$$N(\nu, \beta) \sim \sum_{k=0}^{\infty} \frac{v_{2k}(i \cot \beta)}{\nu^{2k}} \\ = 1 + \frac{135 \cot^2 \beta + 594 \cot^4 \beta + 455 \cot^6 \beta}{1152\nu^2} \dots$$

9.3.22

$$O(\nu, \beta) \sim i \sum_{k=0}^{\infty} \frac{v_{2k+1}(i \cot \beta)}{\nu^{2k+1}} = \frac{9 \cot \beta + 7 \cot^3 \beta}{24\nu} \dots$$

Asymptotic Expansions in the Transition Regions

When  $z$  is fixed,  $|\nu|$  is large and  $|\arg \nu| < \frac{1}{2}\pi$

9.3.23

$$J_\nu(\nu + z\nu^{1/3}) \sim \frac{2^{1/3}}{\nu^{1/3}} \text{Ai}(-2^{1/3}z) \left\{ 1 + \sum_{k=1}^{\infty} \frac{f_k(z)}{\nu^{2k/3}} \right\} \\ + \frac{2^{2/3}}{\nu} \text{Ai}'(-2^{1/3}z) \sum_{k=0}^{\infty} \frac{g_k(z)}{\nu^{2k/3}}$$

9.3.24

$$Y_\nu(\nu + z\nu^{1/3}) \sim -\frac{2^{1/3}}{\nu^{1/3}} \text{Bi}(-2^{1/3}z) \left\{ 1 + \sum_{k=1}^{\infty} \frac{f_k(z)}{\nu^{2k/3}} \right\} \\ - \frac{2^{2/3}}{\nu} \text{Bi}'(-2^{1/3}z) \sum_{k=0}^{\infty} \frac{g_k(z)}{\nu^{2k/3}}$$

where

9.3.25

$$f_1(z) = -\frac{1}{5}z \\ f_2(z) = -\frac{9}{100}z^5 + \frac{3}{35}z^2 \\ f_3(z) = \frac{957}{7000}z^6 - \frac{173}{3150}z^3 - \frac{1}{225} \\ f_4(z) = \frac{27}{20000}z^{10} - \frac{23573}{147000}z^7 + \frac{5903}{138600}z^4 + \frac{947}{346500}z$$

9.3.26

$$g_0(z) = \frac{3}{10}z^2 \\ g_1(z) = -\frac{17}{70}z^3 + \frac{1}{70} \\ g_2(z) = -\frac{9}{1000}z^7 + \frac{611}{3150}z^4 - \frac{37}{3150}z \\ g_3(z) = \frac{549}{28000}z^8 - \frac{110767}{693000}z^5 + \frac{79}{12375}z^2$$

The corresponding expansions for  $H_\nu^{(1)}(\nu + z\nu^{1/3})$  and  $H_\nu^{(2)}(\nu + z\nu^{1/3})$  are obtained by use of 9.1.3 and 9.1.4; they are valid for  $-\frac{1}{2}\pi < \arg \nu < \frac{3}{2}\pi$  and  $-\frac{3}{2}\pi < \arg \nu < \frac{1}{2}\pi$ , respectively.

9.3.27

$$J'_\nu(\nu + z\nu^{1/3}) \sim -\frac{2^{2/3}}{\nu^{2/3}} \text{Ai}'(-2^{1/3}z) \left\{ 1 + \sum_{k=1}^{\infty} \frac{h_k(z)}{\nu^{2k/3}} \right\} \\ + \frac{2^{1/3}}{\nu^{4/3}} \text{Ai}(-2^{1/3}z) \sum_{k=0}^{\infty} \frac{l_k(z)}{\nu^{2k/3}}$$

9.3.28

$$Y'_\nu(\nu + z\nu^{1/3}) \sim \frac{2^{2/3}}{\nu^{2/3}} \text{Bi}'(-2^{1/3}z) \left\{ 1 + \sum_{k=1}^{\infty} \frac{h_k(z)}{\nu^{2k/3}} \right\} \\ - \frac{2^{1/3}}{\nu^{4/3}} \text{Bi}(-2^{1/3}z) \sum_{k=0}^{\infty} \frac{l_k(z)}{\nu^{2k/3}}$$

where

9.3.29

$$h_1(z) = -\frac{4}{5}z \\ h_2(z) = -\frac{9}{100}z^5 + \frac{57}{70}z^2 \\ h_3(z) = \frac{699}{3500}z^6 - \frac{2617}{3150}z^3 + \frac{23}{3150} \\ h_4(z) = \frac{27}{20000}z^{10} - \frac{46631}{147000}z^7 + \frac{3889}{4620}z^4 - \frac{1159}{115500}z$$

9.3.30

$$l_0(z) = \frac{3}{5}z^3 - \frac{1}{5} \\ l_1(z) = -\frac{131}{140}z^4 + \frac{1}{5}z \\ l_2(z) = -\frac{9}{500}z^8 + \frac{5437}{4500}z^5 - \frac{593}{3150}z^2 \\ l_3(z) = \frac{369}{7000}z^9 - \frac{999443}{693000}z^6 + \frac{31727}{173250}z^3 + \frac{947}{346500}$$

$$9.3.31 \quad J_\nu(\nu) \sim \frac{a}{\nu^{1/3}} \left\{ 1 + \sum_{k=1}^{\infty} \frac{\alpha_k}{\nu^{2k}} \right\} - \frac{b}{\nu^{5/3}} \sum_{k=0}^{\infty} \frac{\beta_k}{\nu^{2k}}$$

$$9.3.32 \quad Y_\nu(\nu) \sim -\frac{3^{1/2}a}{\nu^{1/3}} \left\{ 1 + \sum_{k=1}^{\infty} \frac{\alpha_k}{\nu^{2k}} \right\} - \frac{3^{1/2}b}{\nu^{5/3}} \sum_{k=0}^{\infty} \frac{\beta_k}{\nu^{2k}}$$

$$9.3.33 \quad J'_\nu(\nu) \sim \frac{b}{\nu^{2/3}} \left\{ 1 + \sum_{k=1}^{\infty} \frac{\gamma_k}{\nu^{2k}} \right\} - \frac{a}{\nu^{4/3}} \sum_{k=0}^{\infty} \frac{\delta_k}{\nu^{2k}}$$

$$9.3.34 \quad Y'_\nu(\nu) \sim \frac{3^{1/2}b}{\nu^{2/3}} \left\{ 1 + \sum_{k=1}^{\infty} \frac{\gamma_k}{\nu^{2k}} \right\} + \frac{3^{1/2}a}{\nu^{4/3}} \sum_{k=0}^{\infty} \frac{\delta_k}{\nu^{2k}}$$

where

$$a = \frac{2^{1/3}}{3^{2/3}\Gamma(\frac{2}{3})} = .44730 \ 73184, \quad 3^{\frac{1}{2}}a = .77475 \ 90021$$

$$b = \frac{2^{2/3}}{3^{1/3}\Gamma(\frac{1}{3})} = .41085 \ 01939, \quad 3^{\frac{1}{2}}b = .71161 \ 34101$$

$$\alpha_0 = 1, \quad \alpha_1 = -\frac{1}{225} = -.004\dot{4},$$

$$\alpha_2 = .00069 \ 3735 \dots, \quad \alpha_3 = -.00035 \ 38 \dots$$

$$\beta_0 = \frac{1}{70} = .01428 \ 57143 \dots,$$

$$\beta_1 = -\frac{1213}{10 \ 23750} = -.00118 \ 48596 \dots,$$

$$\beta_2 = .00043 \ 78 \dots, \quad \beta_3 = -.00038 \dots$$

$$\gamma_0 = 1, \quad \gamma_1 = \frac{23}{3150} = .00730 \ 15873 \dots,$$

$$\gamma_2 = -.00093 \ 7300 \dots, \quad \gamma_3 = .00044 \ 40 \dots$$

$$\delta_0 = \frac{1}{5}, \quad \delta_1 = -\frac{947}{3 \ 46500} = -.00273 \ 30447 \dots,$$

$$\delta_2 = .00060 \ 47 \dots, \quad \delta_3 = -.00038 \dots$$

**Uniform Asymptotic Expansions**

These are more powerful than the previous expansions of this section, save for 9.3.31 and 9.3.32, but their coefficients are more complicated. They reduce to 9.3.31 and 9.3.32 when the argument equals the order.

**9.3.35**

$$J_\nu(\nu z) \sim \left( \frac{4\zeta}{1-z^2} \right)^{1/4} \left\{ \frac{\text{Ai}(\nu^{2/3}\zeta)}{\nu^{1/3}} \sum_{k=0}^{\infty} \frac{a_k(\zeta)}{\nu^{2k}} + \frac{\text{Ai}'(\nu^{2/3}\zeta)}{\nu^{5/3}} \sum_{k=0}^{\infty} \frac{b_k(\zeta)}{\nu^{2k}} \right\}$$

**9.3.36**

$$Y_\nu(\nu z) \sim -\left( \frac{4\zeta}{1-z^2} \right)^{1/4} \left\{ \frac{\text{Bi}(\nu^{2/3}\zeta)}{\nu^{1/3}} \sum_{k=0}^{\infty} \frac{a_k(\zeta)}{\nu^{2k}} + \frac{\text{Bi}'(\nu^{2/3}\zeta)}{\nu^{5/3}} \sum_{k=0}^{\infty} \frac{b_k(\zeta)}{\nu^{2k}} \right\}$$

**9.3.37**

$$H_\nu^{(1)}(\nu z) \sim 2e^{-\pi i/3} \left( \frac{4\zeta}{1-z^2} \right)^{1/4} \left\{ \frac{\text{Ai}(e^{2\pi i/3}\nu^{2/3}\zeta)}{\nu^{1/3}} \sum_{k=0}^{\infty} \frac{a_k(\zeta)}{\nu^{2k}} + \frac{e^{2\pi i/3} \text{Ai}'(e^{2\pi i/3}\nu^{2/3}\zeta)}{\nu^{5/3}} \sum_{k=0}^{\infty} \frac{b_k(\zeta)}{\nu^{2k}} \right\}$$

When  $\nu \rightarrow +\infty$ , these expansions hold uniformly with respect to  $z$  in the sector  $|\arg z| \leq \pi - \epsilon$ , where  $\epsilon$  is an arbitrary positive number. The corresponding expansion for  $H_\nu^{(2)}(\nu z)$  is obtained by changing the sign of  $i$  in 9.3.37.

Here

**9.3.38**

$$\frac{2}{3} \zeta^{3/2} = \int_z^1 \frac{\sqrt{1-t^2}}{t} dt = \ln \frac{1+\sqrt{1-z^2}}{z} - \sqrt{1-z^2}$$

equivalently,

**9.3.39**

$$\frac{2}{3} (-\zeta)^{3/2} = \int_1^z \frac{\sqrt{t^2-1}}{t} dt = \sqrt{z^2-1} - \arccos \left( \frac{1}{z} \right)$$

the branches being chosen so that  $\zeta$  is real when  $z$  is positive. The coefficients are given by

**9.3.40**

$$a_k(\zeta) = \sum_{s=0}^{2k} \mu_s \zeta^{-3s/2} u_{2k-s} \{ (1-z^2)^{-\frac{1}{2}} \}$$

$$b_k(\zeta) = -\zeta^{-\frac{1}{2}} \sum_{s=0}^{2k+1} \lambda_s \zeta^{-3s/2} u_{2k-s+1} \{ (1-z^2)^{-\frac{1}{2}} \}$$

where  $u_k$  is given by 9.3.9 and 9.3.10,  $\lambda_0 = \mu_0 = 1$  and

**9.3.41**

$$\lambda_s = \frac{(2s+1)(2s+3)\dots(6s-1)}{s!(144)^s}, \quad \mu_s = -\frac{6s+1}{6s-1} \lambda_s$$

Thus  $a_0(\zeta) = 1$ ,

**9.3.42**

$$b_0(\zeta) = -\frac{5}{48\zeta^2} + \frac{1}{\zeta^{\frac{1}{2}}} \left\{ \frac{5}{24(1-z^2)^{3/2}} - \frac{1}{8(1-z^2)^{\frac{1}{2}}} \right\} \\ = -\frac{5}{48\zeta^2} + \frac{1}{(-\zeta)^{\frac{1}{2}}} \left\{ \frac{5}{24(z^2-1)^{3/2}} + \frac{1}{8(z^2-1)^{\frac{1}{2}}} \right\}$$

Tables of the early coefficients are given below. For more extensive tables of the coefficients and for bounds on the remainder terms in 9.3.35 and 9.3.36 see [9.38].



Uniform Expansions of the Derivatives

With the conditions of the preceding subsection

9.3.43

$$J'_\nu(\nu z) \sim -\frac{2}{z} \left(\frac{1-z^2}{4\zeta}\right)^{\frac{1}{2}} \left\{ \frac{\text{Ai}(\nu^{2/3}\zeta)}{\nu^{4/3}} \sum_{k=0}^{\infty} \frac{c_k(\zeta)}{\nu^{2k}} + \frac{\text{Ai}'(\nu^{2/3}\zeta)}{\nu^{2/3}} \sum_{k=0}^{\infty} \frac{d_k(\zeta)}{\nu^{2k}} \right\}$$

9.3.44

$$Y'_\nu(\nu z) \sim \frac{2}{z} \left(\frac{1-z^2}{4\zeta}\right)^{\frac{1}{2}} \left\{ \frac{\text{Bi}(\nu^{2/3}\zeta)}{\nu^{4/3}} \sum_{k=0}^{\infty} \frac{c_k(\zeta)}{\nu^{2k}} + \frac{\text{Bi}'(\nu^{2/3}\zeta)}{\nu^{2/3}} \sum_{k=0}^{\infty} \frac{d_k(\zeta)}{\nu^{2k}} \right\}$$

9.3.45

$$H^{(1)\prime}_\nu(\nu z) \sim \frac{4e^{2\pi i/3}}{z} \left(\frac{1-z^2}{4\zeta}\right)^{\frac{1}{2}} \left\{ \frac{\text{Ai}(e^{2\pi i/3}\nu^{2/3}\zeta)}{\nu^{4/3}} \sum_{k=0}^{\infty} \frac{c_k(\zeta)}{\nu^{2k}} + \frac{e^{2\pi i/3} \text{Ai}'(e^{2\pi i/3}\nu^{2/3}\zeta)}{\nu^{2/3}} \sum_{k=0}^{\infty} \frac{d_k(\zeta)}{\nu^{2k}} \right\}$$

where

9.3.46

$$c_k(\zeta) = -\zeta^{\frac{1}{2}} \sum_{s=0}^{2k+1} \mu_s \zeta^{-3s/2} \nu_{2k-s+1} \{ (1-z^2)^{-\frac{1}{2}} \}$$

$$d_k(\zeta) = \sum_{s=0}^{2k} \lambda_s \zeta^{-3s/2} \nu_{2k-s} \{ (1-z^2)^{-\frac{1}{2}} \}$$

and  $\nu_k$  is given by 9.3.13 and 9.3.14. For bounds on the remainder terms in 9.3.43 and 9.3.44 see [9.38].

| $\zeta$ | $b_0(\zeta)$ | $a_1(\zeta)$ | $c_0(\zeta)$ | $d_1(\zeta)$ |
|---------|--------------|--------------|--------------|--------------|
| 0       | 0.0180       | -0.004       | 0.1587       | 0.007        |
| 1       | .0278        | -.004        | .1785        | .009         |
| 2       | .0351        | -.001        | .1862        | .007         |
| 3       | .0366        | +.002        | .1927        | .005         |
| 4       | .0352        | .003         | .2031        | .004         |
| 5       | .0331        | .004         | .2155        | .003         |
| 6       | .0311        | .004         | .2284        | .003         |
| 7       | .0294        | .004         | .2413        | .003         |
| 8       | .0278        | .004         | .2539        | .003         |
| 9       | .0265        | .004         | .2662        | .003         |
| 10      | .0253        | .004         | .2781        | .003         |

| $-\zeta$ | $b_0(\zeta)$ | $a_1(\zeta)$ | $c_0(\zeta)$ | $d_1(\zeta)$ |
|----------|--------------|--------------|--------------|--------------|
| 0        | 0.0180       | -0.004       | 0.1587       | 0.007        |
| 1        | .0109        | -.003        | .1323        | .004         |
| 2        | .0067        | -.002        | .1087        | .002         |
| 3        | .0044        | -.001        | .0903        | .001         |
| 4        | .0031        | -.001        | .0764        | .001         |
| 5        | .0022        | -.000        | .0658        | .000         |
| 6        | .0017        | -.000        | .0576        | .000         |
| 7        | .0013        | -.000        | .0511        | .000         |
| 8        | .0011        | -.000        | .0459        | .000         |
| 9        | .0009        | -.000        | .0415        | .000         |
| 10       | .0007        | -.000        | .0379        | .000         |

For  $\zeta > 10$  use

$$b_0(\zeta) \sim \frac{1}{12} \zeta^{-\frac{1}{2}} - .104 \zeta^{-2}, \quad a_1(\zeta) = .003,$$

$$c_0(\zeta) \sim \frac{1}{12} \zeta^{\frac{1}{2}} + .146 \zeta^{-1}, \quad d_1(\zeta) = .003.$$

For  $\zeta < -10$  use

$$b_0(\zeta) \sim \frac{1}{12} \zeta^{-2}, \quad a_1(\zeta) = .000,$$

$$c_0(\zeta) \sim -\frac{5}{12} \zeta^{-1} - 1.33(-\zeta)^{-5/2}, \quad d_1(\zeta) = .000.$$

Maximum values of higher coefficients:

$$|b_1(\zeta)| = .003, \quad |a_2(\zeta)| = .0008, \quad |d_2(\zeta)| = .001$$

$$|c_1(\zeta)| = .008 \quad (\zeta < 10), \quad c_1(\zeta) \sim -.003 \zeta^{\frac{1}{2}} \text{ as } \zeta \rightarrow +\infty.$$

9.4. Polynomial Approximations<sup>2</sup>

9.4.1  $-3 \leq x \leq 3$

$$J_0(x) = 1 - 2.24999 \ 97(x/3)^2 + 1.26562 \ 08(x/3)^4$$

$$- .31638 \ 66(x/3)^6 + .04444 \ 79(x/3)^8$$

$$- .00394 \ 44(x/3)^{10} + .00021 \ 00(x/3)^{12} + \epsilon$$

$$|\epsilon| < 5 \times 10^{-8}$$

9.4.2  $0 < x \leq 3$

$$Y_0(x) = (2/\pi) \ln(\frac{1}{2}x) J_0(x) + .36746 \ 691$$

$$+ .60559 \ 366(x/3)^2 - .74350 \ 384(x/3)^4$$

$$+ .25300 \ 117(x/3)^6 - .04261 \ 214(x/3)^8$$

$$+ .00427 \ 916(x/3)^{10} - .00024 \ 846(x/3)^{12} + \epsilon$$

$$|\epsilon| < 1.4 \times 10^{-8}$$

9.4.3  $3 \leq x < \infty$

$$J_0(x) = x^{-\frac{1}{2}} f_0 \cos \theta_0 \quad Y_0(x) = x^{-\frac{1}{2}} f_0 \sin \theta_0$$

$$f_0 = .79788 \ 456 - .00000 \ 077(3/x) - .00552 \ 740(3/x)^2$$

$$- .00009 \ 512(3/x)^3 + .00137 \ 237(3/x)^4$$

$$- .00072 \ 805(3/x)^5 + .00014 \ 476(3/x)^6 + \epsilon$$

$$|\epsilon| < 1.6 \times 10^{-8}$$

<sup>2</sup> Equations 9.4.1 to 9.4.6 and 9.8.1 to 9.8.8 are taken from E. E. Allen, Analytical approximations, Math. Tables Aids Comp. 8, 240-241 (1954), and Polynomial approximations to some modified Bessel functions, Math. Tables Aids Comp. 10, 162-164 (1956) (with permission). They were checked at the National Physical Laboratory by systematic tabulation; new bounds for the errors,  $\epsilon$ , given here were obtained as a result.



$$\begin{aligned} \theta_0 = & x - .78539\ 816 - .04166\ 397(3/x) \\ & - .00003\ 954(3/x)^2 + .00262\ 573(3/x)^3 \\ & - .00054\ 125(3/x)^4 - .00029\ 333(3/x)^5 \\ & + .00013\ 558(3/x)^6 + \epsilon \end{aligned}$$

$$|\epsilon| < 7 \times 10^{-8}$$

9.4.4  $-3 \leq x \leq 3$

$$\begin{aligned} x^{-1} J_1(x) = & \frac{1}{2} - .56249\ 985(x/3)^2 + .21093\ 573(x/3)^4 \\ & - .03954\ 289(x/3)^6 + .00443\ 319(x/3)^8 \\ & - .00031\ 761(x/3)^{10} + .00001\ 109(x/3)^{12} + \epsilon \end{aligned}$$

$$|\epsilon| < 1.3 \times 10^{-8}$$

9.4.5  $0 < x \leq 3$

$$\begin{aligned} xY_1(x) = & (2/\pi)x \ln(\frac{1}{2}x)J_1(x) - .63661\ 98 \\ & + .22120\ 91(x/3)^2 + 2.16827\ 09(x/3)^4 \\ & - 1.31648\ 27(x/3)^6 + .31239\ 51(x/3)^8 \\ & - .04009\ 76(x/3)^{10} + .00278\ 73(x/3)^{12} + \epsilon \end{aligned}$$

$$|\epsilon| < 1.1 \times 10^{-7}$$

9.4.6  $3 \leq x < \infty$

$$J_1(x) = x^{-\frac{1}{2}} f_1 \cos \theta_1, \quad Y_1(x) = x^{-\frac{1}{2}} f_1 \sin \theta_1$$

$$\begin{aligned} f_1 = & .79788\ 456 + .00000\ 156(3/x) + .01659\ 667(3/x)^2 \\ & + .00017\ 105(3/x)^3 - .00249\ 511(3/x)^4 \\ & + .00113\ 653(3/x)^5 - .00020\ 033(3/x)^6 + \epsilon \end{aligned}$$

$$|\epsilon| < 4 \times 10^{-8}$$

$$\begin{aligned} \theta_1 = & x - 2.35619\ 449 + .12499\ 612(3/x) \\ & + .00005\ 650(3/x)^2 - .00637\ 879(3/x)^3 \\ & + .00074\ 348(3/x)^4 + .00079\ 824(3/x)^5 \\ & - .00029\ 166(3/x)^6 + \epsilon \end{aligned}$$

$$|\epsilon| < 9 \times 10^{-8}$$

For expansions of  $J_0(x)$ ,  $Y_0(x)$ ,  $J_1(x)$ , and  $Y_1(x)$  in series of Chebyshev polynomials for the ranges  $0 \leq x \leq 8$  and  $0 \leq 8/x \leq 1$ , see [9.37].

9.5. Zeros

Real Zeros

When  $\nu$  is real, the functions  $J_\nu(z)$ ,  $J'_\nu(z)$ ,  $Y_\nu(z)$  and  $Y'_\nu(z)$  each have an infinite number of real zeros, all of which are simple with the possible exception of  $z=0$ . For non-negative  $\nu$  the  $s$ th positive zeros of these functions are denoted by

$j_{\nu,s}$ ,  $j'_{\nu,s}$ ,  $y_{\nu,s}$  and  $y'_{\nu,s}$  respectively, except that  $z=0$  is counted as the first zero of  $J'_0(z)$ . Since  $J'_0(z) = -J_1(z)$ , it follows that

9.5.1  $j'_{0,1} = 0, \quad j'_{0,s} = j_{1,s-1} \quad (s=2, 3, \dots)$

The zeros interlace according to the inequalities

9.5.2

$$j_{\nu,1} < j_{\nu+1,1} < j'_{\nu,2} < j_{\nu+1,2} < j_{\nu,3} < \dots$$

$$y_{\nu,1} < y_{\nu+1,1} < y_{\nu,2} < y_{\nu+1,2} < y_{\nu,3} < \dots$$

$$\nu \leq j'_{\nu,1} < y_{\nu,1} < y'_{\nu,1} < j_{\nu,1} < j'_{\nu,2}$$

$$< y_{\nu,2} < y'_{\nu,2} < j_{\nu,2} < j'_{\nu,3} < \dots$$

The positive zeros of any two real distinct cylinder functions of the same order are interlaced, as are the positive zeros of any real cylinder function  $\mathcal{C}_\nu(z)$ , defined as in 9.1.27, and the contiguous function  $\mathcal{C}_{\nu+1}(z)$ .

If  $\rho_\nu$  is a zero of the cylinder function

9.5.3  $\mathcal{C}_\nu(z) = J_\nu(z) \cos(\pi t) + Y_\nu(z) \sin(\pi t)$

where  $t$  is a parameter, then

9.5.4  $\mathcal{C}'_\nu(\rho_\nu) = \mathcal{C}_{\nu-1}(\rho_\nu) = -\mathcal{C}_{\nu+1}(\rho_\nu)$

If  $\sigma_\nu$  is a zero of  $\mathcal{C}'_\nu(z)$  then

9.5.5  $\mathcal{C}_\nu(\sigma_\nu) = \frac{\sigma_\nu}{\nu} \mathcal{C}_{\nu-1}(\sigma_\nu) = \frac{\sigma_\nu}{\nu} \mathcal{C}_{\nu+1}(\sigma_\nu)$

The parameter  $t$  may be regarded as a continuous variable and  $\rho_\nu, \sigma_\nu$  as functions  $\rho_\nu(t), \sigma_\nu(t)$  of  $t$ . If these functions are fixed by

9.5.6  $\rho_\nu(0) = 0, \quad \sigma_\nu(0) = j'_{\nu,1}$

then

9.5.7

$$j_{\nu,s} = \rho_\nu(s), \quad y_{\nu,s} = \rho_\nu(s - \frac{1}{2}) \quad (s=1, 2, \dots)$$

9.5.8

$$j'_{\nu,s} = \sigma_\nu(s-1), \quad y'_{\nu,s} = \sigma_\nu(s - \frac{1}{2}) \quad (s=1, 2, \dots)$$

9.5.9  $\mathcal{C}'_\nu(\rho_\nu) = \left(\frac{\rho_\nu}{2} \frac{d\rho_\nu}{dt}\right)^{-\frac{1}{2}}, \quad \mathcal{C}_\nu(\sigma_\nu) = \left(\frac{\sigma_\nu^2 - \nu^2}{2\sigma_\nu} \frac{d\sigma_\nu}{dt}\right)^{-\frac{1}{2}}$

Infinite Products

9.5.10  $J_\nu(z) = \frac{(\frac{1}{2}z)^\nu}{\Gamma(\nu+1)} \prod_{s=1}^{\infty} \left(1 - \frac{z^2}{j_{\nu,s}^2}\right)$

9.5.11  $J'_\nu(z) = \frac{(\frac{1}{2}z)^{\nu-1}}{2\Gamma(\nu)} \prod_{s=1}^{\infty} \left(1 - \frac{z^2}{j'_{\nu,s}^2}\right) \quad (\nu > 0)$

McMahon's Expansions for Large Zeros

When  $\nu$  is fixed,  $s \gg \nu$  and  $\mu = 4\nu^2$

9.5.12

$$j_{\nu,s}, y_{\nu,s} \sim \beta - \frac{\mu-1}{8\beta} - \frac{4(\mu-1)(7\mu-31)}{3(8\beta)^3} - \frac{32(\mu-1)(83\mu^2-982\mu+3779)}{15(8\beta)^5} - \frac{64(\mu-1)(6949\mu^3-153855\mu^2+1585743\mu-6277237)}{105(8\beta)^7} - \dots$$

where  $\beta = (s + \frac{1}{2}\nu - \frac{1}{4})\pi$  for  $j_{\nu,s}$ ,  $\beta = (s + \frac{1}{2}\nu - \frac{3}{4})\pi$  for  $y_{\nu,s}$ . With  $\beta = (t + \frac{1}{2}\nu - \frac{1}{4})\pi$ , the right of 9.5.12 is the asymptotic expansion of  $\rho_\nu(t)$  for large  $t$ .

9.5.13

$$j'_{\nu,s}, y'_{\nu,s} \sim \beta' - \frac{\mu+3}{8\beta'} - \frac{4(7\mu^2+82\mu-9)}{3(8\beta')^3} - \frac{32(83\mu^3+2075\mu^2-3039\mu+3537)}{15(8\beta')^5} - \frac{64(6949\mu^4+296492\mu^3-1248002\mu^2+7414380\mu-5853627)}{105(8\beta')^7} - \dots$$

where  $\beta' = (s + \frac{1}{2}\nu - \frac{3}{4})\pi$  for  $j'_{\nu,s}$ ,  $\beta' = (s + \frac{1}{2}\nu - \frac{1}{4})\pi$  for  $y'_{\nu,s}$ ,  $\beta' = (t + \frac{1}{2}\nu + \frac{1}{4})\pi$  for  $\sigma_\nu(t)$ . For higher terms in 9.5.12 and 9.5.13 see [9.4] or [9.40].

Asymptotic Expansions of Zeros and Associated Values for Large Orders

9.5.14

$$j_{\nu,1} \sim \nu + 1.85575 71\nu^{1/3} + 1.03315 0\nu^{-1/3} - .00397\nu^{-1} - .0908\nu^{-5/3} + .043\nu^{-7/3} + \dots$$

9.5.15

$$y_{\nu,1} \sim \nu + .93157 68\nu^{1/3} + .26035 1\nu^{-1/3} + .01198\nu^{-1} - .0060\nu^{-5/3} - .001\nu^{-7/3} + \dots$$

9.5.16

$$j'_{\nu,1} \sim \nu + .80861 65\nu^{1/3} + .07249 0\nu^{-1/3} - .05097\nu^{-1} + .0094\nu^{-5/3} + \dots$$

9.5.17

$$y'_{\nu,1} \sim \nu + 1.82109 80\nu^{1/3} + .94000 7\nu^{-1/3} - .05808\nu^{-1} - .0540\nu^{-5/3} + \dots$$

9.5.18

$$J'_\nu(j_{\nu,1}) \sim -1.11310 28\nu^{-2/3} / (1 + 1.48460 6\nu^{-2/3} + .43294\nu^{-4/3} - .1943\nu^{-2} + .019\nu^{-8/3} + \dots)$$

9.5.19

$$Y'_\nu(y_{\nu,1}) \sim .95554 86\nu^{-2/3} / (1 + .74526 1\nu^{-2/3} + .10910\nu^{-4/3} - .0185\nu^{-2} - .003\nu^{-8/3} + \dots)$$

9.5.20

$$J_\nu(j'_{\nu,1}) \sim .67488 51\nu^{-1/3} (1 - .16172 3\nu^{-2/3} + .02918\nu^{-4/3} - .0068\nu^{-2} + \dots)$$

9.5.21

$$Y_\nu(y'_{\nu,1}) \sim .57319 40\nu^{-1/3} (1 - .36422 0\nu^{-2/3} + .09077\nu^{-4/3} + .0237\nu^{-2} + \dots)$$

Corresponding expansions for  $s=2, 3$  are given in [9.40]. These expansions become progressively weaker as  $s$  increases; those which follow do not suffer from this defect.

Uniform Asymptotic Expansions of Zeros and Associated Values for Large Orders

9.5.22  $j_{\nu,s} \sim \nu z(\zeta) + \sum_{k=1}^{\infty} \frac{f_k(\zeta)}{\nu^{2k-1}}$  with  $\zeta = \nu^{-2/3} a_s$

9.5.23

$$J'_\nu(j_{\nu,s}) \sim -\frac{2}{\nu^{2/3}} \frac{Ai'(a_s)}{z(\zeta)h(\zeta)} \left\{ 1 + \sum_{k=1}^{\infty} \frac{F_k(\zeta)}{\nu^{2k}} \right\}$$

with  $\zeta = \nu^{-2/3} a_s$

9.5.24  $j'_{\nu,s} \sim \nu z(\zeta) + \sum_{k=1}^{\infty} \frac{g_k(\zeta)}{\nu^{2k-1}}$  with  $\zeta = \nu^{-2/3} a'_s$

9.5.25

$$J_\nu(j'_{\nu,s}) \sim Ai(a'_s) \frac{h(\zeta)}{\nu^{1/3}} \left\{ 1 + \sum_{k=1}^{\infty} \frac{G_k(\zeta)}{\nu^{2k}} \right\}$$
 with  $\zeta = \nu^{-2/3} a'_s$

where  $a_s, a'_s$  are the  $s$ th negative zeros of  $Ai(z)$ ,  $Ai'(z)$  (see 10.4),  $z = z(\zeta)$  is the inverse function defined implicitly by 9.3.39, and

9.5.26

$$h(\zeta) = \{4\zeta/(1-z^2)\}^{1/2}$$

$$f_1(\zeta) = \frac{1}{2}z(\zeta)\{h(\zeta)\}^2 b_0(\zeta)$$

$$g_1(\zeta) = \frac{1}{2}\zeta^{-1}z(\zeta)\{h(\zeta)\}^2 c_0(\zeta)$$

where  $b_0(\zeta), c_0(\zeta)$  appear in 9.3.42 and 9.3.46. Tables of the leading coefficients follow. More extensive tables are given in [9.40].

The expansions of  $y_{\nu,s}, Y'_\nu(y_{\nu,s}), y'_{\nu,s}$  and  $Y_\nu(y'_{\nu,s})$  corresponding to 9.5.22 to 9.5.25 are obtained by changing the symbols  $j, J, Ai, Ai', a_s$  and  $a'_s$  to  $y, Y, -Bi, -Bi', b_s$  and  $b'_s$  respectively.

| $-\zeta$ | $z(\zeta)$ | $h(\zeta)$ | $f_1(\zeta)$ | $F_1(\zeta)$ | $(-\zeta)g_1(\zeta)$ | $(-\zeta)^2g_2(\zeta)$ | $(-\zeta)^3G_1(\zeta)$ |
|----------|------------|------------|--------------|--------------|----------------------|------------------------|------------------------|
| 0.0      | 1.000000   | 1.25992    | 0.0143       | -0.007       | -0.1260              | -0.010                 | 0.000                  |
| 0.2      | 1.166284   | 1.22076    | .0142        | -.005        | -.1335               | -.010                  | .002                   |
| 0.4      | 1.347557   | 1.18337    | .0139        | -.004        | -.1399               | -.009                  | .004                   |
| 0.6      | 1.543615   | 1.14780    | .0135        | -.003        | -.1453               | -.009                  | .005                   |
| 0.8      | 1.754187   | 1.11409    | .0131        | -.003        | -.1498               | -.008                  | .006                   |
| 1.0      | 1.978963   | 1.08220    | 0.0126       | -0.002       | -0.1533              | -0.008                 | 0.006                  |

| $-\zeta$ | $z(\zeta)$ | $h(\zeta)$ | $f_1(\zeta)$ | $F_1(\zeta)$ | $g_1(\zeta)$ | $g_2(\zeta)$ | $G_1(\zeta)$ |
|----------|------------|------------|--------------|--------------|--------------|--------------|--------------|
| 1.0      | 1.978963   | 1.08220    | 0.0126       | -0.002       | -0.1533      | -0.008       | 0.006        |
| 1.2      | 2.217607   | 1.05208    | .0121        | -.002        | -.1301       | -.004        | .004         |
| 1.4      | 2.469770   | 1.02367    | .0115        | -.001        | -.1130       | -.002        | .003         |
| 1.6      | 2.735103   | 0.99687    | .0110        | -.001        | -.0998       | -.001        | .002         |
| 1.8      | 3.013256   | .97159     | .0105        | -.001        | -.0893       | -.001        | .002         |
| 2.0      | 3.303889   | 0.94775    | 0.0100       | -0.001       | -0.0807      | -0.001       | 0.001        |
| 2.2      | 3.606673   | .92524     | .0095        | -0.001       | -.0734       |              | .001         |
| 2.4      | 3.921292   | .90397     | .0091        |              | -.0673       |              | .001         |
| 2.6      | 4.247441   | .88387     | .0086        |              | -.0619       |              | .001         |
| 2.8      | 4.584833   | .86484     | .0082        |              | -.0573       |              | 0.001        |
| 3.0      | 4.933192   | 0.84681    | 0.0078       |              | -0.0533      |              |              |
| 3.2      | 5.292257   | .82972     | .0075        |              | -.0497       |              |              |
| 3.4      | 5.661780   | .81348     | .0071        |              | -.0464       |              |              |
| 3.6      | 6.041525   | .79806     | .0068        |              | -.0436       |              |              |
| 3.8      | 6.431269   | .78338     | .0065        |              | -.0410       |              |              |
| 4.0      | 6.830800   | 0.76939    | 0.0062       |              | -0.0386      |              |              |
| 4.2      | 7.239917   | .75605     | .0060        |              | -.0365       |              |              |
| 4.4      | 7.658427   | .74332     | .0057        |              | -.0345       |              |              |
| 4.6      | 8.086150   | .73115     | .0055        |              | -.0328       |              |              |
| 4.8      | 8.522912   | .71951     | .0052        |              | -.0311       |              |              |
| 5.0      | 8.968548   | 0.70836    | 0.0050       |              | -0.0296      |              |              |
| 5.2      | 9.422900   | .69768     | .0048        |              | -.0282       |              |              |
| 5.4      | 9.885820   | .68742     | .0047        |              | -.0270       |              |              |
| 5.6      | 10.357162  | .67758     | .0045        |              | -.0258       |              |              |
| 5.8      | 10.836791  | .66811     | .0043        |              | -.0246       |              |              |
| 6.0      | 11.324575  | 0.65901    | 0.0042       |              | -0.0236      |              |              |
| 6.2      | 11.820388  | .65024     | .0040        |              | -.0227       |              |              |
| 6.4      | 12.324111  | .64180     | .0039        |              | -.0218       |              |              |
| 6.6      | 12.835627  | .63366     | .0037        |              | -.0209       |              |              |
| 6.8      | 13.354826  | .62580     | .0036        |              | -.0201       |              |              |
| 7.0      | 13.881601  | 0.61821    | 0.0035       |              | -0.0194      |              |              |

| $(-\zeta)^{-1}$ | $z(\zeta) - \frac{3}{2}(-\zeta)^{\frac{3}{2}}$ | $(-\zeta)^{\frac{1}{2}}h(\zeta)$ | $f_1(\zeta)$ | $g_1(\zeta)$ |
|-----------------|--|----------------------------------|--------------|--------------|
| 0.40            | 1.528915                                       | 1.62026                          | 0.0040       | -0.0224      |
| .35             | 1.541532                                       | 1.65351                          | .0029        | -.0158       |
| .30             | 1.551741                                       | 1.68067                          | .0020        | -.0104       |
| .25             | 1.559490                                       | 1.70146                          | .0012        | -.0062       |
| .20             | 1.564907                                       | 1.71607                          | .0006        | -.0033       |
| 0.15            | 1.568285                                       | 1.72523                          | 0.0003       | -0.0014      |
| .10             | 1.570048                                       | 1.73002                          | .0001        | -.0004       |
| .05             | 1.570703                                       | 1.73180                          | .0000        | -.0001       |
| .00             | 1.570796                                       | 1.73205                          | .0000        | -.0000       |

Maximum Values of Higher Coefficients

$|f_2(\zeta)| = .001, |F_2(\zeta)| = .0004 \quad (0 \leq -\zeta < \infty)$   
 $|g_3(\zeta)| = .001, |G_2(\zeta)| = .0007 \quad (1 \leq -\zeta < \infty)$   
 $|(-\zeta)^5g_3(\zeta)| = .002, |(-\zeta)^4G_2(\zeta)| = .0007$   
 $(0 \leq -\zeta \leq 1)$

Complex Zeros of  $J_\nu(x)$

When  $\nu \geq -1$  the zeros of  $J_\nu(z)$  are all real. If  $\nu < -1$  and  $\nu$  is not an integer the number of complex zeros of  $J_\nu(z)$  is twice the integer part of  $(-\nu)$ ; if the integer part of  $(-\nu)$  is odd two of these zeros lie on the imaginary axis.

If  $\nu \geq 0$ , all zeros of  $J'_\nu(z)$  are real.

Complex Zeros of  $Y_\nu(x)$

When  $\nu$  is real the pattern of the complex zeros of  $Y_\nu(z)$  and  $Y'_\nu(z)$  depends on the non-integer part of  $\nu$ . Attention is confined here to the case  $\nu = n$ , a positive integer or zero.

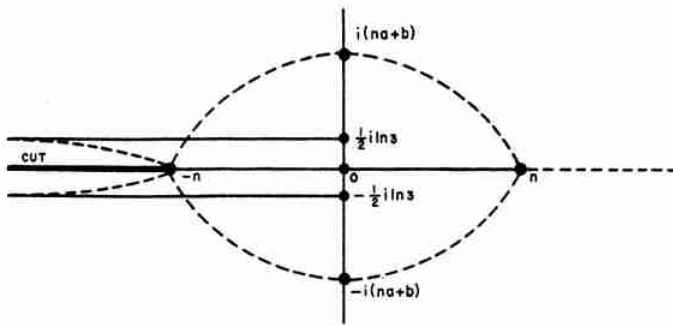

FIGURE 9.5. Zeros of  $Y_n(z)$  and  $Y'_n(z)$  . . .  
 $|\arg z| \leq \pi$ .

Figure 9.5 shows the approximate distribution of the complex zeros of  $Y_n(z)$  in the region  $|\arg z| \leq \pi$ . The figure is symmetrical about the real axis. The two curves on the left extend to infinity, having the asymptotes

$$\mathcal{I}z = \pm \frac{1}{2} \ln 3 = \pm .54931 \dots$$

There are an infinite number of zeros near each of these curves.

The two curves extending from  $z = -n$  to  $z = n$  and bounding an eye-shaped domain intersect the imaginary axis at the points  $\pm i(na + b)$ , where

$$a = \sqrt{t_0^2 - 1} = .66274 \dots$$

$$b = \frac{1}{2} \sqrt{1 - t_0^{-2}} \ln 2 = .19146 \dots$$

and  $t_0 = 1.19968 \dots$  is the positive root of  $\coth t = t$ . There are  $n$  zeros near each of these curves. Asymptotic expansions of these zeros for large  $n$

are given by the right of 9.5.22 with  $\nu = n$  and  $\zeta = n^{-2/3}\beta$ , or  $n^{-2/3}\bar{\beta}$ , where  $\beta_s, \bar{\beta}_s$  are the complex zeros of  $\text{Bi}(z)$  (see 10.4).

Figure 9.5 is also applicable to the zeros of  $Y'_n(z)$ . There are again an infinite number near the infinite curves, and  $n$  near each of the finite curves. Asymptotic expansions of the latter for large  $n$  are given by the right of 9.5.24 with  $\nu = n$  and  $\zeta = n^{-2/3}\beta'_s$ , or  $n^{-2/3}\bar{\beta}'_s$ ; where  $\beta'_s$  and  $\bar{\beta}'_s$  are the complex zeros of  $\text{Bi}'(z)$ .

Numerical values of the three smallest complex zeros of  $Y_0(z)$ ,  $Y_1(z)$  and  $Y'_1(z)$  in the region  $0 < \arg z < \pi$  are given below.

For further details see [9.36] and [9.13]. The latter reference includes tables to facilitate computation.

**Complex Zeros of the Hankel Functions**

The approximate distribution of the zeros of  $H_n^{(1)}(z)$  and its derivative in the region  $|\arg z| \leq \pi$  is indicated in a similar manner on Figure 9.6.

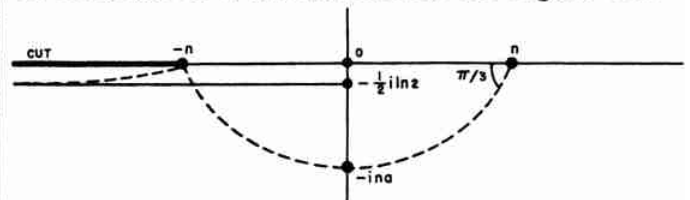

FIGURE 9.6. Zeros of  $H_n^{(1)}(z)$  and  $H_n^{(1)'}(z)$  . . .  
 $|\arg z| \leq \pi$ .

The asymptote of the solitary infinite curve is given by

$$\mathcal{I}z = -\frac{1}{2} \ln 2 = -.34657 \dots$$

*Zeros of  $Y_0(z)$  and Values of  $Y_1(z)$  at the Zeros<sup>3</sup>*

| Zero     |       | $Y_1$   |       |
|----------|-------|---------|-------|
| Real     | Imag. | Real    | Imag. |
| -2.40301 | 6632  | +.53988 | 2313  |
| -5.51987 | 6702  | +.54718 | 0011  |
| -8.65367 | 2403  | +.54841 | 2067  |

*Zeros of  $Y_1(z)$  and Values of  $Y_0(z)$  at the Zeros*

| Zero     |       | $Y_0$   |       |
|----------|-------|---------|-------|
| Real     | Imag. | Real    | Imag. |
| -0.50274 | 3273  | +.78624 | 3714  |
| -3.83353 | 5193  | +.56235 | 6538  |
| -7.01590 | 3683  | +.55339 | 3046  |

*Zeros of  $Y'_1(z)$  and Values of  $Y_1(z)$  at the Zeros*

| Zero     |       | $Y_1$   |       |
|----------|-------|---------|-------|
| Real     | Imag. | Real    | Imag. |
| +0.57678 | 5129  | +.90398 | 4792  |
| -1.94047 | 7342  | +.72118 | 5919  |
| -5.33347 | 8617  | +.56721 | 9637  |

<sup>3</sup> From National Bureau of Standards, Tables of the Bessel functions  $Y_0(z)$  and  $Y_1(z)$  for complex arguments, Columbia Univ. Press, New York, N.Y., 1950 (with permission).

There are  $n$  zeros of each function near the finite curve extending from  $z=-n$  to  $z=n$ ; the asymptotic expansions of these zeros for large  $n$  are given by the right side of 9.5.22 or 9.5.24 with  $\nu=n$  and  $\zeta=e^{-2\pi i/3}n^{-2/3}a_s$  or  $\zeta=e^{-2\pi i/3}n^{-2/3}a'_s$ .

**Zeros of Cross-Products**

If  $\nu$  is real and  $\lambda$  is positive, the zeros of the function

9.5.27  $J_\nu(z)Y_\nu(\lambda z) - J_\nu(\lambda z)Y_\nu(z)$

are real and simple. If  $\lambda > 1$ , the asymptotic expansion of the  $s$ th zero is

9.5.28  $\beta + \frac{p}{\beta} + \frac{q-p^2}{\beta^3} + \frac{r-4pq+2p^3}{\beta^5} + \dots$

where with  $4\nu^2$  denoted by  $\mu$ ,

9.5.29 
$$\beta = s\pi/(\lambda-1)$$

$$p = \frac{\mu-1}{8\lambda}, \quad q = \frac{(\mu-1)(\mu-25)(\lambda^3-1)}{6(4\lambda)^3(\lambda-1)}$$

$$r = \frac{(\mu-1)(\mu^2-114\mu+1073)(\lambda^5-1)}{5(4\lambda)^5(\lambda-1)}$$

The asymptotic expansion of the large positive zeros (not necessarily the  $s$ th) of the function

9.5.30  $J'_\nu(z)Y'_\nu(\lambda z) - J'_\nu(\lambda z)Y'_\nu(z) \quad (\lambda > 1)$

is given by 9.5.28 with the same value of  $\beta$ , but instead of 9.5.29 we have

9.5.31 
$$p = \frac{\mu+3}{8\lambda}, \quad q = \frac{(\mu^2+46\mu-63)(\lambda^3-1)}{6(4\lambda)^3(\lambda-1)}$$

$$r = \frac{(\mu^3+185\mu^2-2053\mu+1899)(\lambda^5-1)}{5(4\lambda)^5(\lambda-1)}$$

The asymptotic expansion of the large positive zeros of the function

9.5.32  $J'_\nu(z)Y_\nu(\lambda z) - Y'_\nu(z)J_\nu(\lambda z)$

is given by 9.5.28 with

9.5.33 
$$\beta = (s-\frac{1}{2})\pi/(\lambda-1)$$

$$p = \frac{(\mu+3)\lambda - (\mu-1)}{8\lambda(\lambda-1)}$$

$$q = \frac{(\mu^2+46\mu-63)\lambda^3 - (\mu-1)(\mu-25)}{6(4\lambda)^3(\lambda-1)}$$

$$5(4\lambda)^5(\lambda-1)r = (\mu^3+185\mu^2-2053\mu+1899)\lambda^5 - (\mu-1)(\mu^2-114\mu+1073)$$

**Modified Bessel Functions  $I$  and  $K$**

**9.6. Definitions and Properties**

**Differential Equation**

9.6.1  $z^2 \frac{d^2 w}{dz^2} + z \frac{dw}{dz} - (z^2 + \nu^2)w = 0$

Solutions are  $I_{\pm\nu}(z)$  and  $K_\nu(z)$ . Each is a regular function of  $z$  throughout the  $z$ -plane cut along the negative real axis, and for fixed  $z$  ( $\neq 0$ ) each is an entire function of  $\nu$ . When  $\nu = \pm n$ ,  $I_\nu(z)$  is an entire function of  $z$ .

$I_\nu(z)$  ( $\Re \nu \geq 0$ ) is bounded as  $z \rightarrow 0$  in any bounded range of  $\arg z$ .  $I_\nu(z)$  and  $I_{-\nu}(z)$  are linearly independent except when  $\nu$  is an integer.  $K_\nu(z)$  tends to zero as  $|z| \rightarrow \infty$  in the sector  $|\arg z| < \frac{1}{2}\pi$ , and for all values of  $\nu$ ,  $I_\nu(z)$  and  $K_\nu(z)$  are linearly independent.  $I_\nu(z)$ ,  $K_\nu(z)$  are real and positive when  $\nu > -1$  and  $z > 0$ .

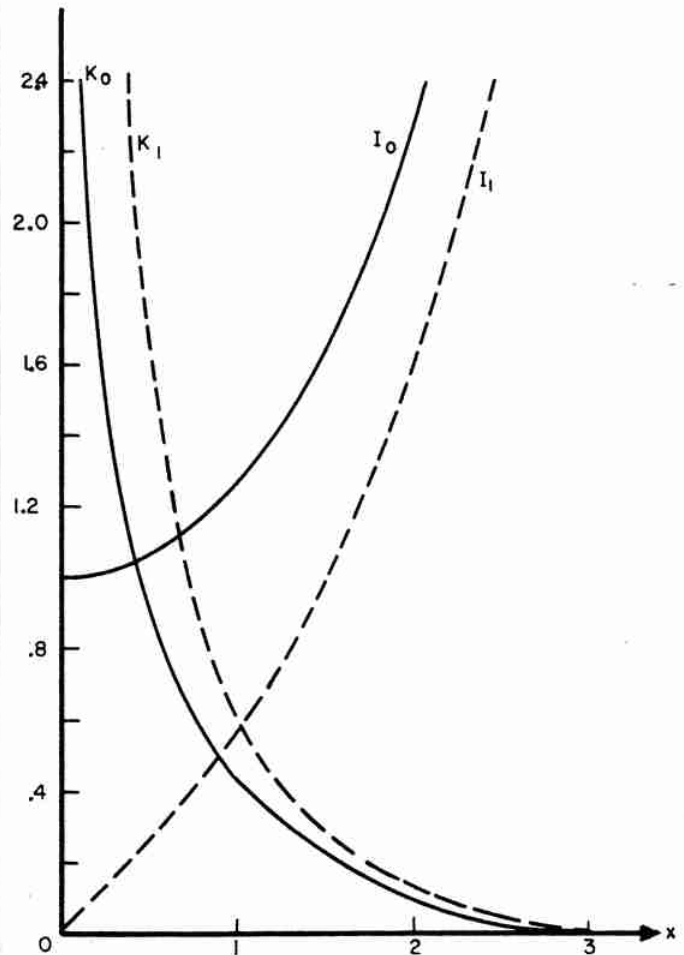

FIGURE 9.7.  $I_0(x)$ ,  $K_0(x)$ ,  $I_1(x)$  and  $K_1(x)$ .

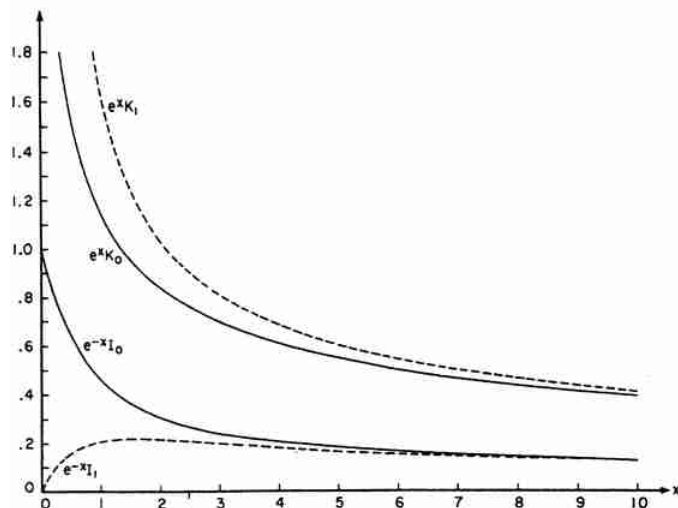

FIGURE 9.8.  $e^{-x}I_0(x), e^{-x}I_1(x), e^xK_0(x)$  and  $e^xK_1(x)$ .

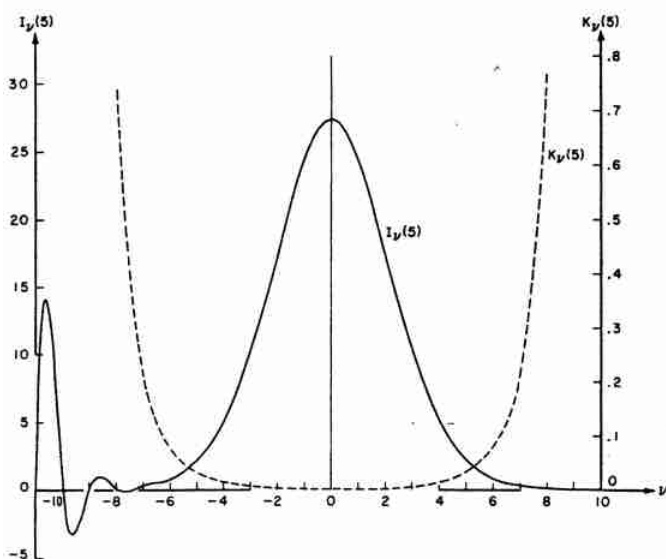

FIGURE 9.9.  $I_5(5)$  and  $K_5(5)$ .

**Relations Between Solutions**

9.6.2 
$$K_\nu(z) = \frac{1}{2}\pi \frac{I_{-\nu}(z) - I_\nu(z)}{\sin(\nu\pi)}$$

The right of this equation is replaced by its limiting value if  $\nu$  is an integer or zero.

9.6.3

$$I_\nu(z) = e^{-i\nu\pi} J_\nu(ze^{i\pi/2}) \quad (-\pi < \arg z \leq \frac{1}{2}\pi)$$

$$I_\nu(z) = e^{3i\nu\pi/2} J_\nu(ze^{-3\pi i/2}) \quad (\frac{1}{2}\pi < \arg z \leq \pi)$$

9.6.4

$$K_\nu(z) = \frac{1}{2}\pi i e^{i\nu\pi} H_\nu^{(1)}(ze^{i\pi/2}) \quad (-\pi < \arg z \leq \frac{1}{2}\pi)$$

$$K_\nu(z) = -\frac{1}{2}\pi i e^{-i\nu\pi} H_\nu^{(2)}(ze^{-i\pi/2}) \quad (-\frac{1}{2}\pi < \arg z \leq \pi)$$

9.6.5

$$Y_\nu(ze^{i\pi/2}) = e^{i(\nu+1)\pi} I_\nu(z) - (2/\pi) e^{-i\nu\pi} K_\nu(z)$$

$(-\pi < \arg z \leq \frac{1}{2}\pi)$

9.6.6  $I_{-\nu}(z) = I_\nu(z), K_{-\nu}(z) = K_\nu(z)$

Most of the properties of modified Bessel functions can be deduced immediately from those of ordinary Bessel functions by application of these relations.

**Limiting Forms for Small Arguments**

When  $\nu$  is fixed and  $z \rightarrow 0$

9.6.7

$$I_\nu(z) \sim (\frac{1}{2}z)^\nu / \Gamma(\nu+1) \quad (\nu \neq -1, -2, \dots)$$

9.6.8

$$K_0(z) \sim -\ln z$$

9.6.9

$$K_\nu(z) \sim \frac{1}{2}\Gamma(\nu)(\frac{1}{2}z)^{-\nu} \quad (\Re \nu > 0)$$

**Ascending Series**

9.6.10 
$$I_\nu(z) = (\frac{1}{2}z)^\nu \sum_{k=0}^{\infty} \frac{(\frac{1}{4}z^2)^k}{k! \Gamma(\nu+k+1)}$$

9.6.11

$$K_n(z) = \frac{1}{2}(\frac{1}{2}z)^{-n} \sum_{k=0}^{n-1} \frac{(n-k-1)!}{k!} (-\frac{1}{4}z^2)^k$$

$$+ (-)^{n+1} \ln(\frac{1}{2}z) I_n(z)$$

$$+ (-)^n \frac{1}{2} (\frac{1}{2}z)^n \sum_{k=0}^{\infty} \{ \psi(k+1) + \psi(n+k+1) \} \frac{(\frac{1}{4}z^2)^k}{k!(n+k)!}$$

where  $\psi(n)$  is given by 6.3.2.

9.6.12 
$$I_0(z) = 1 + \frac{\frac{1}{4}z^2}{(1!)^2} + \frac{(\frac{1}{4}z^2)^2}{(2!)^2} + \frac{(\frac{1}{4}z^2)^3}{(3!)^2} + \dots$$

9.6.13

$$K_0(z) = -\{ \ln(\frac{1}{2}z) + \gamma \} I_0(z) + \frac{\frac{1}{4}z^2}{(1!)^2}$$

$$+ (1 + \frac{1}{2}) \frac{(\frac{1}{4}z^2)^2}{(2!)^2} + (1 + \frac{1}{2} + \frac{1}{3}) \frac{(\frac{1}{4}z^2)^3}{(3!)^2} + \dots$$

**Wronskians**

9.6.14

$$W\{I_\nu(z), I_{-\nu}(z)\} = I_\nu(z) I_{-(\nu+1)}(z) - I_{\nu+1}(z) I_{-\nu}(z)$$

$$= -2 \sin(\nu\pi) / (\pi z)$$

9.6.15

$$W\{K_\nu(z), I_\nu(z)\} = I_\nu(z) K_{\nu+1}(z) + I_{\nu+1}(z) K_\nu(z) = 1/z$$



## Integral Representations

9.6.16

$$I_0(z) = \frac{1}{\pi} \int_0^\pi e^{\pm z \cos \theta} d\theta = \frac{1}{\pi} \int_0^\pi \cosh(z \cos \theta) d\theta$$

$$9.6.17 \quad K_0(z) = -\frac{1}{\pi} \int_0^\pi e^{\pm z \cos \theta} \{\gamma + \ln(2z \sin^2 \theta)\} d\theta$$

9.6.18

$$I_\nu(z) = \frac{(\frac{1}{2}z)^\nu}{\pi^{1/2} \Gamma(\nu + \frac{1}{2})} \int_0^\pi e^{\pm z \cos \theta} \sin^{2\nu} \theta d\theta$$

$$= \frac{(\frac{1}{2}z)^\nu}{\pi^{1/2} \Gamma(\nu + \frac{1}{2})} \int_{-1}^1 (1-t^2)^{\nu-1/2} e^{\pm z t} dt \quad (\Re \nu > -\frac{1}{2})$$

$$9.6.19 \quad I_n(z) = \frac{1}{\pi} \int_0^\pi e^{z \cos \theta} \cos(n\theta) d\theta$$

9.6.20

$$I_\nu(z) = \frac{1}{\pi} \int_0^\pi e^{z \cos \theta} \cos(\nu\theta) d\theta$$

$$= \frac{\sin(\nu\pi)}{\pi} \int_0^\infty e^{-z \cosh t - \nu t} dt \quad (|\arg z| < \frac{1}{2}\pi)$$

9.6.21

$$K_0(x) = \int_0^\infty \cos(x \sinh t) dt = \int_0^\infty \frac{\cos(xt)}{\sqrt{t^2+1}} dt \quad (x > 0)$$

9.6.22

$$K_\nu(x) = \sec(\frac{1}{2}\nu\pi) \int_0^\infty \cos(x \sinh t) \cosh(\nu t) dt$$

$$= \csc(\frac{1}{2}\nu\pi) \int_0^\infty \sin(x \sinh t) \sinh(\nu t) dt$$

$$(|\Re \nu| < 1, x > 0)$$

9.6.23

$$K_\nu(z) = \frac{\pi^{1/2} (\frac{1}{2}z)^\nu}{\Gamma(\nu + \frac{1}{2})} \int_0^\infty e^{-z \cosh t} \sinh^{2\nu} t dt$$

$$= \frac{\pi^{1/2} (\frac{1}{2}z)^\nu}{\Gamma(\nu + \frac{1}{2})} \int_1^\infty e^{-z(t^2-1)^{\nu-1/2}} dt$$

$$(\Re \nu > -\frac{1}{2}, |\arg z| < \frac{1}{2}\pi)$$

$$9.6.24 \quad K_\nu(z) = \int_0^\infty e^{-z \cosh t} \cosh(\nu t) dt \quad (|\arg z| < \frac{1}{2}\pi)$$

9.6.25

$$K_\nu(xz) = \frac{\Gamma(\nu + \frac{1}{2})(2z)^\nu}{\pi^{1/2} x^\nu} \int_0^\infty \frac{\cos(xt) dt}{(t^2+z^2)^{\nu+1/2}}$$

$$(\Re \nu > -\frac{1}{2}, x > 0, |\arg z| < \frac{1}{2}\pi)^*$$

## Recurrence Relations

9.6.26

$$\mathcal{L}_{\nu-1}(z) - \mathcal{L}_{\nu+1}(z) = \frac{2\nu}{z} \mathcal{L}_\nu(z)$$

$$\mathcal{L}'_\nu(z) = \mathcal{L}_{\nu-1}(z) - \frac{\nu}{z} \mathcal{L}_\nu(z)$$

$$\mathcal{L}_{\nu-1}(z) + \mathcal{L}_{\nu+1}(z) = 2\mathcal{L}'_\nu(z)$$

$$\mathcal{L}'_\nu(z) = \mathcal{L}_{\nu+1}(z) + \frac{\nu}{z} \mathcal{L}_\nu(z)$$

$\mathcal{L}_\nu$  denotes  $I_\nu$ ,  $e^{\nu\pi i} K_\nu$ , or any linear combination of these functions, the coefficients in which are independent of  $z$  and  $\nu$ .

$$9.6.27 \quad I'_0(z) = I_1(z), \quad K'_0(z) = -K_1(z)$$

## Formulas for Derivatives

9.6.28

$$\left(\frac{1}{z} \frac{d}{dz}\right)^k \{z^\nu \mathcal{L}_\nu(z)\} = z^{\nu-k} \mathcal{L}_{\nu-k}(z)$$

$$\left(\frac{1}{z} \frac{d}{dz}\right)^k \{z^{-\nu} \mathcal{L}_\nu(z)\} = z^{-\nu-k} \mathcal{L}_{\nu+k}(z) \quad (k=0, 1, 2, \dots)$$

9.6.29

$$\mathcal{L}_\nu^{(k)}(z) = \frac{1}{2^k} \left\{ \mathcal{L}_{\nu-k}(z) + \binom{k}{1} \mathcal{L}_{\nu-k+2}(z) \right. \\ \left. + \binom{k}{2} \mathcal{L}_{\nu-k+4}(z) + \dots + \mathcal{L}_{\nu+k}(z) \right\}$$

$$(k=0, 1, 2, \dots)$$

## Analytic Continuation

$$9.6.30 \quad I_\nu(ze^{m\pi i}) = e^{m\nu\pi i} I_\nu(z) \quad (m \text{ an integer})$$

9.6.31

$$K_\nu(ze^{m\pi i}) = e^{-m\nu\pi i} K_\nu(z) - \pi i \sin(m\nu\pi) \csc(\nu\pi) I_\nu(z)$$

$$(m \text{ an integer})$$

$$9.6.32 \quad I_\nu(\bar{z}) = \overline{I_\nu(z)}, \quad K_\nu(\bar{z}) = \overline{K_\nu(z)} \quad (\nu \text{ real})$$

## Generating Function and Associated Series

$$9.6.33 \quad e^{\frac{1}{2}z(t+1/t)} = \sum_{k=-\infty}^{\infty} t^k I_k(z) \quad (t \neq 0)$$

$$9.6.34 \quad e^{z \cos \theta} = I_0(z) + 2 \sum_{k=1}^{\infty} I_k(z) \cos(k\theta)$$

9.6.35

$$e^{z \sin \theta} = I_0(z) + 2 \sum_{k=0}^{\infty} (-1)^k I_{2k+1}(z) \sin\{(2k+1)\theta\}$$

$$+ 2 \sum_{k=1}^{\infty} (-1)^k I_{2k}(z) \cos(2k\theta)$$

$$9.6.36 \quad 1 = I_0(z) - 2I_2(z) + 2I_4(z) - 2I_6(z) + \dots$$

$$9.6.37 \quad e^z = I_0(z) + 2I_1(z) + 2I_2(z) + 2I_3(z) + \dots$$

$$9.6.38 \quad e^{-z} = I_0(z) - 2I_1(z) + 2I_2(z) - 2I_3(z) + \dots$$

9.6.39

$$\cosh z = I_0(z) + 2I_2(z) + 2I_4(z) + 2I_6(z) + \dots$$

$$9.6.40 \quad \sinh z = 2I_1(z) + 2I_3(z) + 2I_5(z) + \dots$$



Other Differential Equations

The quantity  $\lambda^2$  in equations 9.1.49 to 9.1.54 and 9.1.56 can be replaced by  $-\lambda^2$  if at the same time the symbol  $\mathcal{C}$  in the given solutions is replaced by  $\mathcal{L}$ .

9.6.41

$$z^2 w'' + z(1 \pm 2z)w' + (\pm z - \nu^2)w = 0, \quad w = e^{\mp z} \mathcal{L}_\nu(z)$$

Differential equations for products may be obtained from 9.1.57 to 9.1.59 by replacing  $z$  by  $iz$ .

Derivatives With Respect to Order

9.6.42

$$\frac{\partial}{\partial \nu} I_\nu(z) = I_\nu(z) \ln\left(\frac{1}{2}z\right) - \left(\frac{1}{2}z\right)^\nu \sum_{k=0}^{\infty} \frac{\psi(\nu+k+1)}{\Gamma(\nu+k+1)} \frac{\left(\frac{1}{2}z\right)^k}{k!}$$

9.6.43

$$\frac{\partial}{\partial \nu} K_\nu(z) = \frac{1}{2}\pi \csc(\nu\pi) \left\{ \frac{\partial}{\partial \nu} I_{-\nu}(z) - \frac{\partial}{\partial \nu} I_\nu(z) \right\} - \pi \cot(\nu\pi) K_\nu(z) \quad (\nu \neq 0, \pm 1, \pm 2, \dots)$$

9.6.44

$$(-1)^n \left[ \frac{\partial}{\partial \nu} I_\nu(z) \right]_{\nu=-n} = -K_n(z) + \frac{n! \left(\frac{1}{2}z\right)^{-n}}{2} \sum_{k=0}^{n-1} (-1)^k \frac{\left(\frac{1}{2}z\right)^k I_k(z)}{(n-k)k!}$$

9.6.45

$$\left[ \frac{\partial}{\partial \nu} K_\nu(z) \right]_{\nu=-n} = \frac{n! \left(\frac{1}{2}z\right)^{-n}}{2} \sum_{k=0}^{n-1} \frac{\left(\frac{1}{2}z\right)^k K_k(z)}{(n-k)k!}$$

9.6.46

$$\left[ \frac{\partial}{\partial \nu} I_\nu(z) \right]_{\nu=0} = -K_0(z), \quad \left[ \frac{\partial}{\partial \nu} K_\nu(z) \right]_{\nu=0} = 0$$

Expressions in Terms of Hypergeometric Functions

9.6.47

$$I_\nu(z) = \frac{\left(\frac{1}{2}z\right)^\nu}{\Gamma(\nu+1)} {}_0F_1(\nu+1; \frac{1}{2}z^2) = \frac{\left(\frac{1}{2}z\right)^\nu e^{-z}}{\Gamma(\nu+1)} M\left(\nu+\frac{1}{2}, 2\nu+1, 2z\right) = \frac{z^{-\frac{1}{2}} M_{0,\nu}(2z)}{2^{2\nu+1} \Gamma(\nu+1)}$$

9.6.48

$$K_\nu(z) = \left(\frac{\pi}{2z}\right)^{\frac{1}{2}} W_{0,\nu}(2z)$$

( ${}_0F_1$  is the generalized hypergeometric function. For  $M(a, b, z)$ ,  $M_{0,\nu}(z)$  and  $W_{0,\nu}(z)$  see chapter 13.)

Connection With Legendre Functions

If  $\mu$  and  $z$  are fixed,  $\Re z > 0$ , and  $\nu \rightarrow \infty$  through real positive values

9.6.49  $\lim \{ \nu^{-\mu} P_{\nu}^{-\mu} \left( \cosh \frac{z}{\nu} \right) \} = I_\mu(z)$

9.6.50  $\lim \{ \nu^{-\mu} e^{-\mu x} Q_{\nu}^{\mu} \left( \cosh \frac{z}{\nu} \right) \} = K_\mu(z)$

For the definition of  $P_{\nu}^{-\mu}$  and  $Q_{\nu}^{\mu}$ , see chapter 8.

Multiplication Theorems

9.6.51

$$\mathcal{L}_\nu(\lambda z) = \lambda^{\pm \nu} \sum_{k=0}^{\infty} \frac{(\lambda^2 - 1)^k \left(\frac{1}{2}z\right)^k}{k!} \mathcal{L}_{\nu \pm k}(z) \quad (|\lambda^2 - 1| < 1)$$

If  $\mathcal{L} = I$  and the upper signs are taken, the restriction on  $\lambda$  is unnecessary.

9.6.52

$$I_\nu(z) = \sum_{k=0}^{\infty} \frac{z^k}{k!} J_{\nu+k}(z), \quad J_\nu(z) = \sum_{k=0}^{\infty} (-1)^k \frac{z^k}{k!} I_{\nu+k}(z)$$

Neumann Series for  $K_n(z)$

9.6.53

$$K_n(z) = (-1)^{n-1} \{ \ln\left(\frac{1}{2}z\right) - \psi(n+1) \} I_n(z) + \frac{n! \left(\frac{1}{2}z\right)^{-n}}{2} \sum_{k=0}^{n-1} (-1)^k \frac{\left(\frac{1}{2}z\right)^k I_k(z)}{(n-k)k!} + (-1)^n \sum_{k=1}^{\infty} \frac{(n+2k) I_{n+2k}(z)}{k(n+k)}$$

9.6.54  $K_0(z) = - \{ \ln\left(\frac{1}{2}z\right) + \gamma \} I_0(z) + 2 \sum_{k=1}^{\infty} \frac{I_{2k}(z)}{k}$

Zeros

Properties of the zeros of  $I_\nu(z)$  and  $K_\nu(z)$  may be deduced from those of  $J_\nu(z)$  and  $H_\nu^{(1)}(z)$  respectively, by application of the transformations 9.6.3 and 9.6.4.

For example, if  $\nu$  is real the zeros of  $I_\nu(z)$  are all complex unless  $-2k < \nu < -(2k-1)$  for some positive integer  $k$ , in which event  $I_\nu(z)$  has two real zeros.

The approximate distribution of the zeros of  $K_n(z)$  in the region  $-\frac{3}{2}\pi \leq \arg z \leq \frac{1}{2}\pi$  is obtained on rotating Figure 9.6 through an angle  $-\frac{1}{2}\pi$  so that the cut lies along the positive imaginary axis. The zeros in the region  $-\frac{1}{2}\pi \leq \arg z \leq \frac{3}{2}\pi$  are their conjugates.  $K_n(z)$  has no zeros in the region  $|\arg z| \leq \frac{1}{2}\pi$ ; this result remains true when  $n$  is replaced by any real number  $\nu$ .

9.7. Asymptotic Expansions

Asymptotic Expansions for Large Arguments

When  $\nu$  is fixed,  $|z|$  is large and  $\mu = 4\nu^2$

9.7.1

$$I_\nu(z) \sim \frac{e^z}{\sqrt{2\pi z}} \left\{ 1 - \frac{\mu-1}{8z} + \frac{(\mu-1)(\mu-9)}{2!(8z)^2} - \frac{(\mu-1)(\mu-9)(\mu-25)}{3!(8z)^3} + \dots \right\} \quad (|\arg z| < \frac{1}{2}\pi)$$

## 9.7.2

$$K_\nu(z) \sim \sqrt{\frac{\pi}{2z}} e^{-z} \left\{ 1 + \frac{\mu-1}{8z} + \frac{(\mu-1)(\mu-9)}{2!(8z)^2} + \frac{(\mu-1)(\mu-9)(\mu-25)}{3!(8z)^3} + \dots \right\} \quad (|\arg z| < \frac{3}{2}\pi)$$

## 9.7.3

$$I'_\nu(z) \sim \frac{e^z}{\sqrt{2\pi z}} \left\{ 1 - \frac{\mu+3}{8z} + \frac{(\mu-1)(\mu+15)}{2!(8z)^2} - \frac{(\mu-1)(\mu-9)(\mu+35)}{3!(8z)^3} + \dots \right\} \quad (|\arg z| < \frac{1}{2}\pi)$$

## 9.7.4

$$K'_\nu(z) \sim -\sqrt{\frac{\pi}{2z}} e^{-z} \left\{ 1 + \frac{\mu+3}{8z} + \frac{(\mu-1)(\mu+15)}{2!(8z)^2} + \frac{(\mu-1)(\mu-9)(\mu+35)}{3!(8z)^3} + \dots \right\} \quad (|\arg z| < \frac{3}{2}\pi)$$

The general terms in the last two expansions can be written down by inspection of 9.2.15 and 9.2.16.

If  $\nu$  is real and non-negative and  $z$  is positive the remainder after  $k$  terms in the expansion 9.7.2 does not exceed the  $(k+1)$ th term in absolute value and is of the same sign, provided that  $k \geq \nu - \frac{1}{2}$ .

## 9.7.5

$$I_\nu(z)K_\nu(z) \sim \frac{1}{2z} \left\{ 1 - \frac{1}{2} \frac{\mu-1}{(2z)^2} + \frac{1 \cdot 3}{2 \cdot 4} \frac{(\mu-1)(\mu-9)}{(2z)^4} - \dots \right\} \quad (|\arg z| < \frac{1}{2}\pi)$$

## 9.7.6

$$I'_\nu(z)K'_\nu(z) \sim -\frac{1}{2z} \left\{ 1 + \frac{1}{2} \frac{\mu-3}{(2z)^2} - \frac{1 \cdot 1}{2 \cdot 4} \frac{(\mu-1)(\mu-45)}{(2z)^4} + \dots \right\} \quad (|\arg z| < \frac{1}{2}\pi)$$

The general terms can be written down by inspection of 9.2.28 and 9.2.30.

## Uniform Asymptotic Expansions for Large Orders

$$9.7.7 \quad I_\nu(\nu z) \sim \frac{1}{\sqrt{2\pi\nu}} \frac{e^{\nu\eta}}{(1+z^2)^{1/4}} \left\{ 1 + \sum_{k=1}^{\infty} \frac{u_k(t)}{\nu^k} \right\}$$

## 9.7.8

$$K_\nu(\nu z) \sim \sqrt{\frac{\pi}{2\nu}} \frac{e^{-\nu\eta}}{(1+z^2)^{1/4}} \left\{ 1 + \sum_{k=1}^{\infty} (-)^k \frac{u_k(t)}{\nu^k} \right\}$$

$$9.7.9 \quad I'_\nu(\nu z) \sim \frac{1}{\sqrt{2\pi\nu}} \frac{(1+z^2)^{1/4}}{z} e^{\nu\eta} \left\{ 1 + \sum_{k=1}^{\infty} \frac{v_k(t)}{\nu^k} \right\}$$

## 9.7.10

$$K'_\nu(\nu z) \sim -\sqrt{\frac{\pi}{2\nu}} \frac{(1+z^2)^{1/4}}{z} e^{-\nu\eta} \left\{ 1 + \sum_{k=1}^{\infty} (-)^k \frac{v_k(t)}{\nu^k} \right\}$$

When  $\nu \rightarrow +\infty$ , these expansions hold uniformly with respect to  $z$  in the sector  $|\arg z| \leq \frac{1}{2}\pi - \epsilon$ , where  $\epsilon$  is an arbitrary positive number. Here

$$9.7.11 \quad t = 1/\sqrt{1+z^2}, \quad \eta = \sqrt{1+z^2} + \ln \frac{z}{1+\sqrt{1+z^2}}$$

and  $u_k(t)$ ,  $v_k(t)$  are given by 9.3.9, 9.3.10, 9.3.13 and 9.3.14. See [9.38] for tables of  $\eta$ ,  $u_k(t)$ ,  $v_k(t)$ , and also for bounds on the remainder terms in 9.7.7 to 9.7.10.

9.8. Polynomial Approximations<sup>4</sup>

In equations 9.8.1 to 9.8.4,  $t = x/3.75$ .

$$9.8.1 \quad -3.75 \leq x \leq 3.75$$

$$I_0(x) = 1 + 3.51562 29t^2 + 3.08994 24t^4 + 1.20674 92t^6 + .26597 32t^8 + .03607 68t^{10} + .00458 13t^{12} + \epsilon$$

$$|\epsilon| < 1.6 \times 10^{-7}$$

$$9.8.2 \quad 3.75 \leq x < \infty$$

$$x^{\frac{1}{2}} e^{-x} I_0(x) = .39894 228 + .01328 592t^{-1} + .00225 319t^{-2} - .00157 565t^{-3} + .00916 281t^{-4} - .02057 706t^{-5} + .02635 537t^{-6} - .01647 633t^{-7} + .00392 377t^{-8} + \epsilon$$

$$|\epsilon| < 1.9 \times 10^{-7}$$

$$9.8.3 \quad -3.75 \leq x \leq 3.75$$

$$x^{-1} I_1(x) = \frac{1}{2} + .87890 594t^2 + .51498 869t^4 + .15084 934t^6 + .02658 733t^8 + .00301 532t^{10} + .00032 411t^{12} + \epsilon$$

$$|\epsilon| < 8 \times 10^{-9}$$

$$9.8.4 \quad 3.75 \leq x < \infty$$

$$x^{\frac{1}{2}} e^{-x} I_1(x) = .39894 228 - .03988 024t^{-1} - .00362 018t^{-2} + .00163 801t^{-3} - .01031 555t^{-4} + .02282 967t^{-5} - .02895 312t^{-6} + .01787 654t^{-7} - .00420 059t^{-8} + \epsilon$$

$$|\epsilon| < 2.2 \times 10^{-7}$$

<sup>4</sup> See footnote 2, section 9.4.

9.8.5  $0 < x \leq 2$

$$K_0(x) = -\ln(x/2)I_0(x) - .57721\ 566 \\ + .42278\ 420(x/2)^2 + .23069\ 756(x/2)^4 \\ + .03488\ 590(x/2)^6 + .00262\ 698(x/2)^8 \\ + .00010\ 750(x/2)^{10} + .00000\ 740(x/2)^{12} + \epsilon \\ |\epsilon| < 1 \times 10^{-8}$$

9.8.6  $2 \leq x < \infty$

$$x^{\frac{1}{2}}e^x K_0(x) = 1.25331\ 414 - .07832\ 358(2/x) \\ + .02189\ 568(2/x)^2 - .01062\ 446(2/x)^3 \\ + .00587\ 872(2/x)^4 - .00251\ 540(2/x)^5 \\ + .00053\ 208(2/x)^6 + \epsilon \\ |\epsilon| < 1.9 \times 10^{-7}$$

9.8.7  $0 < x \leq 2$

$$xK_1(x) = x \ln(x/2)I_1(x) + 1 + .15443\ 144(x/2)^2 \\ - .67278\ 579(x/2)^4 - .18156\ 897(x/2)^6 \\ - .01919\ 402(x/2)^8 - .00110\ 404(x/2)^{10} \\ - .00004\ 686(x/2)^{12} + \epsilon \\ |\epsilon| < 8 \times 10^{-9}$$

9.8.8  $2 \leq x < \infty$

$$x^{\frac{1}{2}}e^x K_1(x) = 1.25331\ 414 + .23498\ 619(2/x) \\ - .03655\ 620(2/x)^2 + .01504\ 268(2/x)^3 \\ - .00780\ 353(2/x)^4 + .00325\ 614(2/x)^5 \\ - .00068\ 245(2/x)^6 + \epsilon \\ |\epsilon| < 2.2 \times 10^{-7}$$

For expansions of  $I_0(x)$ ,  $K_0(x)$ ,  $I_1(x)$ , and  $K_1(x)$  in series of Chebyshev polynomials for the ranges  $0 \leq x \leq 8$  and  $0 \leq 8/x \leq 1$ , see [9.37].

**Kelvin Functions**

**9.9. Definitions and Properties**

In this and the following section  $\nu$  is real,  $x$  is real and non-negative, and  $n$  is again a positive integer or zero.

**Definitions**

9.9.1

$$\text{ber}_\nu x + i \text{bei}_\nu x = J_\nu(xe^{3\pi i/4}) = e^{\nu\pi i} J_\nu(xe^{-\pi i/4}) \\ = e^{\frac{1}{2}\nu\pi i} I_\nu(xe^{\pi i/4}) = e^{\frac{3}{2}\nu\pi i/2} I_\nu(xe^{-3\pi i/4})$$

9.9.2

$$\text{ker}_\nu x + i \text{kei}_\nu x = e^{-\frac{1}{2}\nu\pi i} K_\nu(xe^{\pi i/4}) \\ = \frac{1}{2}\pi i H_\nu^{(1)}(xe^{3\pi i/4}) = -\frac{1}{2}\pi i e^{-\nu\pi i} H_\nu^{(2)}(xe^{-\pi i/4})$$

When  $\nu=0$ , suffices are usually suppressed.

**Differential Equations**

9.9.3

$$x^2 w'' + xw' - (ix^2 + \nu^2)w = 0, \\ w = \text{ber}_\nu x + i \text{bei}_\nu x, \quad \text{ber}_{-\nu} x + i \text{bei}_{-\nu} x, \\ \text{ker}_\nu x + i \text{kei}_\nu x, \quad \text{ker}_{-\nu} x + i \text{kei}_{-\nu} x$$

9.9.4

$$x^4 w^{(4)} + 2x^3 w''' - (1 + 2\nu^2)(x^2 w'' - xw') \\ + (\nu^4 - 4\nu^2 + x^4)w = 0, \\ w = \text{ber}_{\pm\nu} x, \text{bei}_{\pm\nu} x, \text{ker}_{\pm\nu} x, \text{kei}_{\pm\nu} x$$

**Relations Between Solutions**

9.9.5

$$\text{ber}_{-\nu} x = \cos(\nu\pi) \text{ber}_\nu x + \sin(\nu\pi) \text{bei}_\nu x \\ + (2/\pi) \sin(\nu\pi) \text{ker}_\nu x \\ \text{bei}_{-\nu} x = -\sin(\nu\pi) \text{ber}_\nu x + \cos(\nu\pi) \text{bei}_\nu x \\ + (2/\pi) \sin(\nu\pi) \text{kei}_\nu x$$

9.9.6

$$\text{ker}_{-\nu} x = \cos(\nu\pi) \text{ker}_\nu x - \sin(\nu\pi) \text{kei}_\nu x \\ \text{kei}_{-\nu} x = \sin(\nu\pi) \text{ker}_\nu x + \cos(\nu\pi) \text{kei}_\nu x$$

9.9.7  $\text{ber}_{-n} x = (-1)^n \text{ber}_n x, \text{bei}_{-n} x = (-1)^n \text{bei}_n x$

9.9.8  $\text{ker}_{-n} x = (-1)^n \text{ker}_n x, \text{kei}_{-n} x = (-1)^n \text{kei}_n x$

**Ascending Series**

9.9.9

$$\text{ber}_\nu x = \left(\frac{1}{2}x\right)^\nu \sum_{k=0}^{\infty} \frac{\cos\left\{\left(\frac{3}{4}\nu + \frac{1}{2}k\right)\pi\right\}}{k! \Gamma(\nu+k+1)} \left(\frac{1}{4}x^2\right)^k \\ \text{bei}_\nu x = \left(\frac{1}{2}x\right)^\nu \sum_{k=0}^{\infty} \frac{\sin\left\{\left(\frac{3}{4}\nu + \frac{1}{2}k\right)\pi\right\}}{k! \Gamma(\nu+k+1)} \left(\frac{1}{4}x^2\right)^k$$

9.9.10

$$\text{ber } x = 1 - \frac{\left(\frac{1}{4}x^2\right)^2}{(2!)^2} + \frac{\left(\frac{1}{4}x^2\right)^4}{(4!)^2} - \dots \\ \text{bei } x = \frac{1}{4}x^2 - \frac{\left(\frac{1}{4}x^2\right)^3}{(3!)^2} + \frac{\left(\frac{1}{4}x^2\right)^5}{(5!)^2} - \dots$$

9.9.11

$$\text{ker}_n x = \frac{1}{2} \left(\frac{1}{2}x\right)^{-n} \sum_{k=0}^{n-1} \cos\left\{\left(\frac{3}{4}n + \frac{1}{2}k\right)\pi\right\} \\ \times \frac{(n-k-1)!}{k!} \left(\frac{1}{4}x^2\right)^k - \ln\left(\frac{1}{2}x\right) \text{ber}_n x + \frac{1}{4}\pi \text{bei}_n x \\ + \frac{1}{2} \left(\frac{1}{2}x\right)^n \sum_{k=0}^{\infty} \cos\left\{\left(\frac{3}{4}n + \frac{1}{2}k\right)\pi\right\} \\ \times \frac{\{\psi(k+1) + \psi(n+k+1)\}}{k!(n+k)!} \left(\frac{1}{4}x^2\right)^k$$

$$\begin{aligned} \text{kei}_n x &= -\frac{1}{2} \left(\frac{1}{2}x\right)^{-n} \sum_{k=0}^{n-1} \sin \left\{ \left(\frac{1}{2}n + \frac{1}{2}k\right)\pi \right\} \\ &\times \frac{(n-k-1)!}{k!} \left(\frac{1}{2}x^2\right)^k - \ln \left(\frac{1}{2}x\right) \text{bei}_n x - \frac{1}{4}\pi \text{ber}_n x \\ &+ \frac{1}{2} \left(\frac{1}{2}x\right)^n \sum_{k=0}^{\infty} \sin \left\{ \left(\frac{1}{2}n + \frac{1}{2}k\right)\pi \right\} \\ &\times \frac{\{\psi(k+1) + \psi(n+k+1)\}}{k!(n+k)!} \left(\frac{1}{2}x^2\right)^k \end{aligned}$$

where  $\psi(n)$  is given by 6.3.2.

### 9.9.12

$$\begin{aligned} \text{ker } x &= -\ln \left(\frac{1}{2}x\right) \text{ber } x + \frac{1}{4}\pi \text{bei } x \\ &+ \sum_{k=0}^{\infty} (-1)^k \frac{\psi(2k+1)}{\{(2k)!\}^2} \left(\frac{1}{2}x^2\right)^{2k} \\ \text{kei } x &= -\ln \left(\frac{1}{2}x\right) \text{bei } x - \frac{1}{4}\pi \text{ber } x \\ &+ \sum_{k=0}^{\infty} (-1)^k \frac{\psi(2k+2)}{\{(2k+1)!\}^2} \left(\frac{1}{2}x^2\right)^{2k+1} \end{aligned}$$

### Functions of Negative Argument

In general Kelvin functions have a branch point at  $x=0$  and individual functions with arguments  $xe^{\pm\pi i}$  are complex. The branch point is absent however in the case of  $\text{ber}_\nu$  and  $\text{bei}_\nu$  when  $\nu$  is an integer, and

### 9.9.13

$$\text{ber}_n(-x) = (-1)^n \text{ber}_n x, \quad \text{bei}_n(-x) = (-1)^n \text{bei}_n x$$

### Recurrence Relations

#### 9.9.14

$$\begin{aligned} f_{\nu+1} + f_{\nu-1} &= -\frac{\nu\sqrt{2}}{x} (f_\nu - g_\nu) \\ f'_\nu &= \frac{1}{2\sqrt{2}} (f_{\nu+1} + g_{\nu+1} - f_{\nu-1} - g_{\nu-1}) \\ f'_\nu - \frac{\nu}{x} f_\nu &= \frac{1}{\sqrt{2}} (f_{\nu+1} + g_{\nu+1}) \\ f'_\nu + \frac{\nu}{x} f_\nu &= -\frac{1}{\sqrt{2}} (f_{\nu-1} + g_{\nu-1}) \end{aligned}$$

where

#### 9.9.15

$$\left. \begin{aligned} f_\nu &= \text{ber}_\nu x \\ g_\nu &= \text{bei}_\nu x \end{aligned} \right\} \left. \begin{aligned} f_\nu &= \text{bei}_\nu x \\ g_\nu &= -\text{ber}_\nu x \end{aligned} \right\}$$

$$\left. \begin{aligned} f_\nu &= \text{ker}_\nu x \\ g_\nu &= \text{kei}_\nu x \end{aligned} \right\} \left. \begin{aligned} f_\nu &= \text{kei}_\nu x \\ g_\nu &= -\text{ker}_\nu x \end{aligned} \right\}$$

#### 9.9.16

$$\sqrt{2} \text{ber}' x = \text{ber}_1 x + \text{bei}_1 x$$

$$\sqrt{2} \text{bei}' x = -\text{ber}_1 x + \text{bei}_1 x$$

#### 9.9.17

$$\sqrt{2} \text{ker}' x = \text{ker}_1 x + \text{kei}_1 x$$

$$\sqrt{2} \text{kei}' x = -\text{ker}_1 x + \text{kei}_1 x$$

### Recurrence Relations for Cross-Products

If

#### 9.9.18

$$\begin{aligned} p_\nu &= \text{ber}_\nu^2 x + \text{bei}_\nu^2 x \\ q_\nu &= \text{ber}_\nu x \text{bei}'_\nu x - \text{ber}'_\nu x \text{bei}_\nu x \\ r_\nu &= \text{ber}_\nu x \text{ber}'_\nu x + \text{bei}_\nu x \text{bei}'_\nu x \\ s_\nu &= \text{ber}_\nu'^2 x + \text{bei}_\nu'^2 x \end{aligned}$$

then

#### 9.9.19

$$\begin{aligned} p_{\nu+1} &= p_{\nu-1} - \frac{4\nu}{x} r_\nu \\ q_{\nu+1} &= -\frac{\nu}{x} p_\nu + r_\nu = -q_{\nu-1} + 2r_\nu \\ r_{\nu+1} &= -\frac{(\nu+1)}{x} p_{\nu+1} + q_\nu \\ s_\nu &= \frac{1}{2} p_{\nu+1} + \frac{1}{2} p_{\nu-1} - \frac{\nu^2}{x^2} p_\nu \end{aligned}$$

and

#### 9.9.20

$$p_\nu s_\nu = r_\nu^2 + q_\nu^2$$

The same relations hold with  $\text{ber}$ ,  $\text{bei}$  replaced throughout by  $\text{ker}$ ,  $\text{kei}$ , respectively.

### Indefinite Integrals

In the following  $f_\nu$ ,  $g_\nu$  are any one of the pairs given by equations 9.9.15 and  $f'_\nu$ ,  $g'_\nu$  are either the same pair or any other pair.

#### 9.9.21

$$\int x^{1+\nu} f_\nu dx = -\frac{x^{1+\nu}}{\sqrt{2}} (f_{\nu+1} - g_{\nu+1}) = -x^{1+\nu} \left(\frac{\nu}{x} g_\nu - g'_\nu\right)$$

#### 9.9.22

$$\int x^{1-\nu} f_\nu dx = \frac{x^{1-\nu}}{\sqrt{2}} (f_{\nu-1} - g_{\nu-1}) = x^{1-\nu} \left(\frac{\nu}{x} g_\nu + g'_\nu\right)$$

#### 9.9.23

$$\begin{aligned} \int x(f_\nu g'_\nu - g_\nu f'_\nu) dx &= \frac{x}{2\sqrt{2}} \{f'_\nu (f_{\nu+1} + g_{\nu+1}) \\ &- g'_\nu (f_{\nu+1} - g_{\nu+1}) - f_\nu (f'_{\nu+1} + g'_{\nu+1}) + g_\nu (f'_{\nu+1} - g'_{\nu+1})\} \\ &= \frac{1}{2} x (f'_\nu f'_\nu - f_\nu f'_\nu + g'_\nu g'_\nu - g_\nu g'_\nu) \end{aligned}$$

9.9.24

$$\int x(f_\nu g_\nu^* + g_\nu f_\nu^*) dx = \frac{1}{4} x^2 (2f_\nu g_\nu^* - f_{\nu-1} g_{\nu+1}^* - f_{\nu+1} g_{\nu-1}^* + 2g_\nu f_\nu^* - g_{\nu-1} f_{\nu+1}^* - g_{\nu+1} f_{\nu-1}^*)$$

9.9.25

$$\int x(f_\nu^2 + g_\nu^2) dx = x(f_\nu g_\nu' - f_\nu' g_\nu) = -(x/\sqrt{2})(f_\nu f_{\nu+1} + g_\nu g_{\nu+1} - f_\nu g_{\nu+1} + f_{\nu+1} g_\nu)$$

9.9.26

$$\int x f_\nu g_\nu dx = \frac{1}{4} x^2 (2f_\nu g_\nu - f_{\nu-1} g_{\nu+1} - f_{\nu+1} g_{\nu-1})$$

9.9.27

$$\int x(f_\nu^2 - g_\nu^2) dx = \frac{1}{2} x^2 (f_\nu^2 - f_{\nu-1} f_{\nu+1} - g_\nu^2 + g_{\nu-1} g_{\nu+1})$$

Ascending Series for Cross-Products

9.9.28

$$\text{ber}_\nu^2 x + \text{bei}_\nu^2 x = \left(\frac{1}{2}x\right)^{2\nu} \sum_{k=0}^{\infty} \frac{1}{\Gamma(\nu+k+1)\Gamma(\nu+2k+1)} \frac{\left(\frac{1}{2}x^2\right)^{2k}}{k!}$$

9.9.29

$$\text{ber}_\nu x \text{ bei}'_\nu x - \text{ber}'_\nu x \text{ bei}_\nu x = \left(\frac{1}{2}x\right)^{2\nu+1} \sum_{k=0}^{\infty} \frac{1}{\Gamma(\nu+k+1)\Gamma(\nu+2k+2)} \frac{\left(\frac{1}{2}x^2\right)^{2k}}{k!}$$

9.9.30

$$\text{ber}_\nu x \text{ ber}'_\nu x + \text{bei}_\nu x \text{ bei}'_\nu x = \frac{1}{2} \left(\frac{1}{2}x\right)^{2\nu-1} \sum_{k=0}^{\infty} \frac{1}{\Gamma(\nu+k+1)\Gamma(\nu+2k)} \frac{\left(\frac{1}{2}x^2\right)^{2k}}{k!}$$

9.9.31

$$\text{ber}'_\nu x + \text{bei}'_\nu x = \left(\frac{1}{2}x\right)^{2\nu-2} \sum_{k=0}^{\infty} \frac{(2k^2 + 2\nu k + \frac{1}{2}\nu^2)}{\Gamma(\nu+k+1)\Gamma(\nu+2k+1)} \frac{\left(\frac{1}{2}x^2\right)^{2k}}{k!}$$

Expansions in Series of Bessel Functions

9.9.32

$$\text{ber}_\nu x + i \text{bei}_\nu x = \sum_{k=0}^{\infty} \frac{e^{(3\nu+k)\pi i/4} x^{2k} J_{\nu+k}(x)}{2^{2k} k!} = \sum_{k=0}^{\infty} \frac{e^{(3\nu+3k)\pi i/4} x^{2k} I_{\nu+k}(x)}{2^{2k} k!}$$

9.9.33

$$\text{ber}_\nu(x\sqrt{2}) = \sum_{k=-\infty}^{\infty} (-)^{n+k} J_{n+2k}(x) I_{2k}(x)$$

$$\text{bei}_\nu(x\sqrt{2}) = \sum_{k=-\infty}^{\infty} (-)^{n+k} J_{n+2k+1}(x) I_{2k+1}(x)$$

Zeros of Functions of Order Zero <sup>5</sup>

|          | ber x     | bei x     | ker x     | kei x     |
|----------|-----------|-----------|-----------|-----------|
| 1st zero | 2. 84892  | 5. 02622  | 1. 71854  | 3. 91467  |
| 2nd zero | 7. 23883  | 9. 45541  | 6. 12728  | 8. 34422  |
| 3rd zero | 11. 67396 | 13. 89349 | 10. 56294 | 12. 78256 |
| 4th zero | 16. 11356 | 18. 33398 | 15. 00269 | 17. 22314 |
| 5th zero | 20. 55463 | 22. 77544 | 19. 44381 | 21. 66464 |
|          | ber' x    | bei' x    | ker' x    | kei' x    |
| 1st zero | 6. 03871  | 3. 77320  | 2. 66584  | 4. 93181  |
| 2nd zero | 10. 51364 | 8. 28099  | 7. 17212  | 9. 40405  |
| 3rd zero | 14. 96844 | 12. 74215 | 11. 63218 | 13. 85827 |
| 4th zero | 19. 41758 | 17. 19343 | 16. 08312 | 18. 30717 |
| 5th zero | 23. 86430 | 21. 64114 | 20. 53068 | 22. 75379 |

9.10. Asymptotic Expansions

Asymptotic Expansions for Large Arguments

When  $\nu$  is fixed and  $x$  is large

9.10.1

$$\text{ber}_\nu x = \frac{e^{x/\sqrt{2}}}{\sqrt{2\pi x}} \{f_\nu(x) \cos \alpha + g_\nu(x) \sin \alpha\} - \frac{1}{\pi} \{ \sin(2\nu\pi) \text{ker}_\nu x + \cos(2\nu\pi) \text{kei}_\nu x \}$$

9.10.2

$$\text{bei}_\nu x = \frac{e^{x/\sqrt{2}}}{\sqrt{2\pi x}} \{f_\nu(x) \sin \alpha - g_\nu(x) \cos \alpha\} + \frac{1}{\pi} \{ \cos(2\nu\pi) \text{ker}_\nu x - \sin(2\nu\pi) \text{kei}_\nu x \}$$

9.10.3

$$\text{ker}_\nu x = \sqrt{\pi/(2x)} e^{-x/\sqrt{2}} \{f_\nu(-x) \cos \beta - g_\nu(-x) \sin \beta\}$$

9.10.4

$$\text{kei}_\nu x = \sqrt{\pi/(2x)} e^{-x/\sqrt{2}} \{-f_\nu(-x) \sin \beta - g_\nu(-x) \cos \beta\}$$

where

9.10.5

$$\alpha = (x/\sqrt{2}) + (\frac{1}{2}\nu - \frac{1}{8})\pi, \quad \beta = (x/\sqrt{2}) + (\frac{1}{2}\nu + \frac{1}{8})\pi = \alpha + \frac{1}{4}\pi$$

and, with  $4\nu^2$  denoted by  $\mu$ ,

9.10.6

$$f_\nu(\pm x) \sim 1 + \sum_{k=1}^{\infty} (\mp)^k \frac{(\mu-1)(\mu-9) \dots \{\mu - (2k-1)^2\}}{k!(8x)^k} \cos\left(\frac{k\pi}{4}\right)$$

<sup>5</sup> From British Association for the Advancement of Science, Annual Report (J. R. Airey), 254 (1927) with permission. This reference also gives 5-decimal values of the next five zeros of each function.

9.10.7

$g_\nu(\pm x)$

$$\sim \sum_{k=1}^{\infty} (\mp)^k \frac{(\mu-1)(\mu-9) \dots \{\mu-(2k-1)^2\}}{k!(8x)^k} \sin\left(\frac{k\pi}{4}\right)$$

The terms<sup>6</sup> in  $\ker, x$  and  $\text{kei}, x$  in equations 9.10.1 and 9.10.2 are asymptotically negligible compared with the other terms, but their inclusion in numerical calculations yields improved accuracy.

The corresponding series for  $\text{ber}'_v x, \text{bei}'_v x, \text{ker}'_v x$  and  $\text{kei}'_v x$  can be derived from 9.2.11 and 9.2.13 with  $z = xe^{3\pi i/4}$ ; the extra terms in the expansions of  $\text{ber}'_v x$  and  $\text{bei}'_v x$  are respectively

$$-(1/\pi) \{ \sin(2\nu\pi) \text{ker}'_v x + \cos(2\nu\pi) \text{kei}'_v x \}$$

and

$$(1/\pi) \{ \cos(2\nu\pi) \text{ker}'_v x - \sin(2\nu\pi) \text{kei}'_v x \}.$$

Modulus and Phase

9.10.8

$$M_\nu = \sqrt{(\text{ber}_\nu^2 x + \text{bei}_\nu^2 x)}, \quad \theta_\nu = \arctan(\text{bei}_\nu x / \text{ber}_\nu x)$$

9.10.9  $\text{ber}_\nu x = M_\nu \cos \theta_\nu, \quad \text{bei}_\nu x = M_\nu \sin \theta_\nu,$

9.10.10  $M_{-\nu} = M_\nu, \quad \theta_{-\nu} = \theta_\nu - \nu\pi$

9.10.11

$$\begin{aligned} \text{ber}'_\nu x &= \frac{1}{2} M_{\nu+1} \cos(\theta_{\nu+1} - \frac{1}{4}\pi) - \frac{1}{2} M_{\nu-1} \cos(\theta_{\nu-1} - \frac{1}{4}\pi) \\ &= (\nu/x) M_\nu \cos \theta_\nu + M_{\nu+1} \cos(\theta_{\nu+1} - \frac{1}{4}\pi) \\ &= -(\nu/x) M_\nu \cos \theta_\nu - M_{\nu-1} \cos(\theta_{\nu-1} - \frac{1}{4}\pi) \end{aligned}$$

9.10.12

$$\begin{aligned} \text{bei}'_\nu x &= \frac{1}{2} M_{\nu+1} \sin(\theta_{\nu+1} - \frac{1}{4}\pi) - \frac{1}{2} M_{\nu-1} \sin(\theta_{\nu-1} - \frac{1}{4}\pi) \\ &= (\nu/x) M_\nu \sin \theta_\nu + M_{\nu+1} \sin(\theta_{\nu+1} - \frac{1}{4}\pi) \\ &= -(\nu/x) M_\nu \sin \theta_\nu - M_{\nu-1} \sin(\theta_{\nu-1} - \frac{1}{4}\pi) \end{aligned}$$

9.10.13

$$\text{ber}'_\nu x = M_\nu \cos(\theta_\nu - \frac{1}{4}\pi), \quad \text{bei}'_\nu x = M_\nu \sin(\theta_\nu - \frac{1}{4}\pi)$$

9.10.14

$$\begin{aligned} M'_\nu &= (\nu/x) M_\nu + M_{\nu+1} \cos(\theta_{\nu+1} - \theta_\nu - \frac{1}{4}\pi) \\ &= -(\nu/x) M_\nu - M_{\nu-1} \cos(\theta_{\nu-1} - \theta_\nu - \frac{1}{4}\pi) \end{aligned}$$

9.10.15

$$\begin{aligned} \theta'_\nu &= (M_{\nu+1}/M_\nu) \sin(\theta_{\nu+1} - \theta_\nu - \frac{1}{4}\pi) \\ &= -(M_{\nu-1}/M_\nu) \sin(\theta_{\nu-1} - \theta_\nu - \frac{1}{4}\pi) \end{aligned}$$

<sup>6</sup> The coefficients of these terms given in [9.17] are incorrect. The present results are due to Mr. G. F. Miller.

9.10.16

$$\begin{aligned} M'_0 &= M_1 \cos(\theta_1 - \theta_0 - \frac{1}{4}\pi) \\ \theta'_0 &= (M_1/M_0) \sin(\theta_1 - \theta_0 - \frac{1}{4}\pi) \end{aligned}$$

9.10.17

$$d(xM_\nu^2 \theta'_\nu)/dx = 2M_\nu^2, \quad x^2 M''_\nu + xM'_\nu - \nu^2 M_\nu = x^2 M_\nu \theta_\nu'^2$$

9.10.18

$$N_\nu = \sqrt{(\text{ker}_\nu^2 x + \text{kei}_\nu^2 x)}, \quad \phi_\nu = \arctan(\text{kei}_\nu x / \text{ker}_\nu x)$$

9.10.19  $\text{ker}_\nu x = N_\nu \cos \phi_\nu, \quad \text{kei}_\nu x = N_\nu \sin \phi_\nu,$

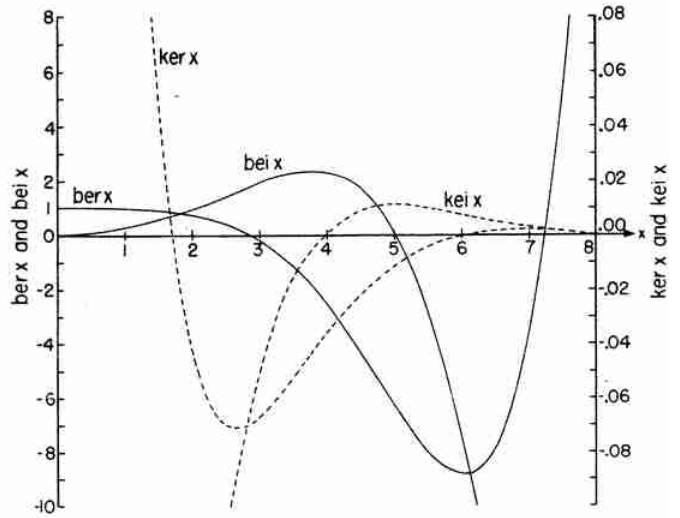

FIGURE 9.10.  $\text{ber } x, \text{bei } x, \text{ker } x$  and  $\text{kei } x.$

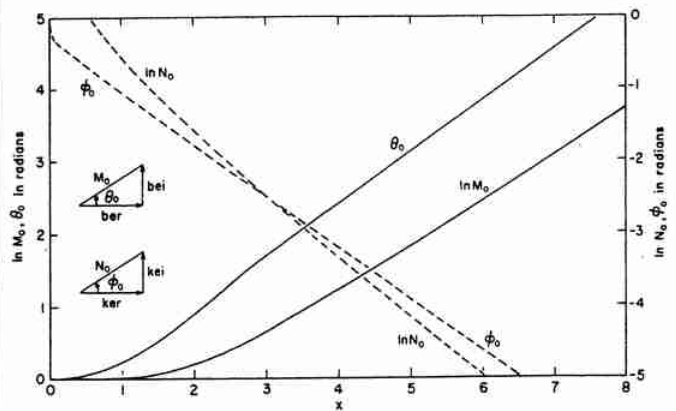

FIGURE 9.11.  $\ln M_0(x), \theta_0(x), \ln N_0(x)$  and  $\phi_0(x).$

Equations 9.10.11 to 9.10.17 hold with the symbols  $b, M, \theta$  replaced throughout by  $k, N, \phi$ , respectively. In place of 9.10.10

9.10.20  $N_{-\nu} = N_\nu, \quad \phi_{-\nu} = \phi_\nu + \nu\pi$



Asymptotic Expansions of Modulus and Phase

When  $\nu$  is fixed,  $x$  is large and  $\mu=4\nu^2$

9.10.21

$$M_\nu = \frac{e^{x/\sqrt{2}}}{\sqrt{2\pi x}} \left\{ 1 - \frac{\mu-1}{8\sqrt{2}} \frac{1}{x} + \frac{(\mu-1)^2}{256} \frac{1}{x^2} - \frac{(\mu-1)(\mu^2+14\mu-399)}{6144\sqrt{2}} \frac{1}{x^3} + O\left(\frac{1}{x^4}\right) \right\}$$

9.10.22

$$\ln M_\nu = \frac{x}{\sqrt{2}} - \frac{1}{2} \ln(2\pi x) - \frac{\mu-1}{8\sqrt{2}} \frac{1}{x} - \frac{(\mu-1)(\mu-25)}{384\sqrt{2}} \frac{1}{x^2} - \frac{(\mu-1)(\mu-13)}{128} \frac{1}{x^3} + O\left(\frac{1}{x^5}\right)$$

9.10.23

$$\theta_\nu = \frac{x}{\sqrt{2}} + \left(\frac{1}{2}\nu - \frac{1}{8}\right)\pi + \frac{\mu-1}{8\sqrt{2}} \frac{1}{x} + \frac{\mu-1}{16} \frac{1}{x^2} - \frac{(\mu-1)(\mu-25)}{384\sqrt{2}} \frac{1}{x^3} + O\left(\frac{1}{x^5}\right)$$

9.10.24

$$N_\nu = \sqrt{\frac{\pi}{2x}} e^{-x/\sqrt{2}} \left\{ 1 + \frac{\mu-1}{8\sqrt{2}} \frac{1}{x} + \frac{(\mu-1)^2}{256} \frac{1}{x^2} + \frac{(\mu-1)(\mu^2+14\mu-399)}{6144\sqrt{2}} \frac{1}{x^3} + O\left(\frac{1}{x^4}\right) \right\}$$

9.10.25

$$\ln N_\nu = -\frac{x}{\sqrt{2}} + \frac{1}{2} \ln\left(\frac{\pi}{2x}\right) + \frac{\mu-1}{8\sqrt{2}} \frac{1}{x} + \frac{(\mu-1)(\mu-25)}{384\sqrt{2}} \frac{1}{x^2} - \frac{(\mu-1)(\mu-13)}{128} \frac{1}{x^3} + O\left(\frac{1}{x^5}\right)$$

9.10.26

$$\phi_\nu = -\frac{x}{\sqrt{2}} - \left(\frac{1}{2}\nu + \frac{1}{8}\right)\pi - \frac{\mu-1}{8\sqrt{2}} \frac{1}{x} + \frac{\mu-1}{16} \frac{1}{x^2} + \frac{(\mu-1)(\mu-25)}{384\sqrt{2}} \frac{1}{x^3} + O\left(\frac{1}{x^5}\right)$$

Asymptotic Expansions of Cross-Products

If  $x$  is large

9.10.27

$$\text{ber}^2 x + \text{bei}^2 x \sim \frac{e^{x\sqrt{2}}}{2\pi x} \left( 1 + \frac{1}{4\sqrt{2}} \frac{1}{x} + \frac{1}{64} \frac{1}{x^2} - \frac{33}{256\sqrt{2}} \frac{1}{x^3} - \frac{1797}{8192} \frac{1}{x^4} + \dots \right)$$

9.10.28

$$\text{ber } x \text{ bei}' x - \text{ber}' x \text{ bei } x \sim \frac{e^{x\sqrt{2}}}{2\pi x} \left( \frac{1}{\sqrt{2}} + \frac{1}{8} \frac{1}{x} + \frac{9}{64\sqrt{2}} \frac{1}{x^2} + \frac{39}{512} \frac{1}{x^3} + \frac{75}{8192\sqrt{2}} \frac{1}{x^4} + \dots \right)$$

9.10.29

$$\text{ber } x \text{ ber}' x + \text{bei } x \text{ bei}' x \sim \frac{e^{x\sqrt{2}}}{2\pi x} \left( \frac{1}{\sqrt{2}} - \frac{3}{8} \frac{1}{x} - \frac{15}{64\sqrt{2}} \frac{1}{x^2} - \frac{45}{512} \frac{1}{x^3} + \frac{315}{8192\sqrt{2}} \frac{1}{x^4} + \dots \right)$$

9.10.30

$$\text{ber}'^2 x + \text{bei}'^2 x \sim \frac{e^{x\sqrt{2}}}{2\pi x} \left( 1 - \frac{3}{4\sqrt{2}} \frac{1}{x} + \frac{9}{64} \frac{1}{x^2} + \frac{75}{256\sqrt{2}} \frac{1}{x^3} + \frac{2475}{8192} \frac{1}{x^4} + \dots \right)$$

9.10.31

$$\text{ker}^2 x + \text{kei}^2 x \sim \frac{\pi}{2x} e^{-x\sqrt{2}} \left( 1 - \frac{1}{4\sqrt{2}} \frac{1}{x} + \frac{1}{64} \frac{1}{x^2} + \frac{33}{256\sqrt{2}} \frac{1}{x^3} - \frac{1797}{8192} \frac{1}{x^4} + \dots \right)$$

9.10.32

$$\text{ker } x \text{ kei}' x - \text{ker}' x \text{ kei } x \sim -\frac{\pi}{2x} e^{-x\sqrt{2}} \left( \frac{1}{\sqrt{2}} - \frac{1}{8} \frac{1}{x} + \frac{9}{64\sqrt{2}} \frac{1}{x^2} - \frac{39}{512} \frac{1}{x^3} + \frac{75}{8192\sqrt{2}} \frac{1}{x^4} + \dots \right)$$

9.10.33

$$\text{ker } x \text{ ker}' x + \text{kei } x \text{ kei}' x \sim -\frac{\pi}{2x} e^{-x\sqrt{2}} \left( \frac{1}{\sqrt{2}} + \frac{3}{8} \frac{1}{x} - \frac{15}{64\sqrt{2}} \frac{1}{x^2} + \frac{45}{512} \frac{1}{x^3} + \frac{315}{8192\sqrt{2}} \frac{1}{x^4} + \dots \right)$$

9.10.34

$$\text{ker}'^2 x + \text{kei}'^2 x \sim \frac{\pi}{2x} e^{-x\sqrt{2}} \left( 1 + \frac{3}{4\sqrt{2}} \frac{1}{x} + \frac{9}{64} \frac{1}{x^2} - \frac{75}{256\sqrt{2}} \frac{1}{x^3} + \frac{2475}{8192} \frac{1}{x^4} + \dots \right)$$

Asymptotic Expansions of Large Zeros

Let

9.10.35

$$f(\delta) = \frac{\mu-1}{16\delta} + \frac{\mu-1}{32\delta^2} + \frac{(\mu-1)(5\mu+19)}{1536\delta^3} + \frac{3(\mu-1)^2}{512\delta^4} + \dots$$

where  $\mu=4\nu^2$ . Then if  $s$  is a large positive integer

9.10.36

|  |  |
|--|--|
| Zeros of ber, $x \sim \sqrt{2}\{\delta - f(\delta)\}$ ,  | $\delta = (s - \frac{1}{2}\nu - \frac{3}{8})\pi$ |
| Zeros of bei, $x \sim \sqrt{2}\{\delta - f(\delta)\}$ ,  | $\delta = (s - \frac{1}{2}\nu + \frac{1}{8})\pi$ |
| Zeros of ker, $x \sim \sqrt{2}\{\delta + f(-\delta)\}$ , | $\delta = (s - \frac{1}{2}\nu - \frac{5}{8})\pi$ |
| Zeros of kei, $x \sim \sqrt{2}\{\delta + f(-\delta)\}$ , | $\delta = (s - \frac{1}{2}\nu - \frac{1}{8})\pi$ |



For  $\nu=0$  these expressions give the sth zero of each function; for other values of  $\nu$  the zeros represented may not be the sth.

### Uniform Asymptotic Expansions for Large Orders

When  $\nu$  is large and positive

#### 9.10.37

$\text{ber}_\nu(\nu x) + i \text{bei}_\nu(\nu x) \sim$

$$\frac{e^{\nu\xi}}{\sqrt{2\pi\nu\xi}} \left( \frac{x e^{3\pi i/4}}{1+\xi} \right)^\nu \left\{ 1 + \sum_{k=1}^{\infty} \frac{u_k(\xi^{-1})}{\nu^k} \right\}$$

#### 9.10.38

$\text{ker}_\nu(\nu x) + i \text{kei}_\nu(\nu x)$

$$\sim \sqrt{\frac{\pi}{2\nu\xi}} e^{-\nu\xi} \left( \frac{x e^{3\pi i/4}}{1+\xi} \right)^{-\nu} \left\{ 1 + \sum_{k=1}^{\infty} (-)^k \frac{u_k(\xi^{-1})}{\nu^k} \right\}$$

#### 9.10.39

$\text{ber}'_\nu(\nu x) + i \text{bei}'_\nu(\nu x)$

$$\sim \sqrt{\frac{\xi}{2\pi\nu}} \frac{e^{\nu\xi}}{x} \left( \frac{x e^{3\pi i/4}}{1+\xi} \right)^\nu \left\{ 1 + \sum_{k=1}^{\infty} \frac{v_k(\xi^{-1})}{\nu^k} \right\}$$

#### 9.10.40

$\text{ker}'_\nu(\nu x) + i \text{kei}'_\nu(\nu x)$

$$\sim -\sqrt{\frac{\pi\xi}{2\nu}} \frac{e^{-\nu\xi}}{x} \left( \frac{x e^{3\pi i/4}}{1+\xi} \right)^{-\nu} \left\{ 1 + \sum_{k=1}^{\infty} (-)^k \frac{v_k(\xi^{-1})}{\nu^k} \right\}$$

where

$$9.10.41 \quad \xi = \sqrt{1+i} x^2$$

and  $u_k(t), v_k(t)$  are given by 9.3.9 and 9.3.13. All fractional powers take their principal values.

### 9.11. Polynomial Approximations

#### 9.11.1 $-8 \leq x \leq 8$

$$\begin{aligned} \text{ber } x = & 1 - 64(x/8)^4 + 113.77777 \ 774(x/8)^8 \\ & - 32.36345 \ 652(x/8)^{12} + 2.64191 \ 397(x/8)^{16} \\ & - .08349 \ 609(x/8)^{20} + .00122 \ 552(x/8)^{24} \\ & - .00000 \ 901(x/8)^{28} + \epsilon \\ & |\epsilon| < 1 \times 10^{-9} \end{aligned}$$

#### 9.11.2 $-8 \leq x \leq 8$

$$\begin{aligned} \text{bei } x = & 16(x/8)^2 - 113.77777 \ 774(x/8)^6 \\ & + 72.81777 \ 742(x/8)^{10} - 10.56765 \ 779(x/8)^{14} \\ & + .52185 \ 615(x/8)^{18} - .01103 \ 667(x/8)^{22} \\ & + .00011 \ 346(x/8)^{26} + \epsilon \\ & |\epsilon| < 6 \times 10^{-9} \end{aligned}$$

#### 9.11.3 $0 < x \leq 8$

$$\begin{aligned} \text{ker } x = & -\ln(\tfrac{1}{2}x) \text{ber } x + \tfrac{1}{4}\pi \text{bei } x - .57721 \ 566 \\ & - 59.05819 \ 744(x/8)^4 + 171.36272 \ 133(x/8)^8 \\ & - 60.60977 \ 451(x/8)^{12} + 5.65539 \ 121(x/8)^{16} \\ & - .19636 \ 347(x/8)^{20} + .00309 \ 699(x/8)^{24} \\ & - .00002 \ 458(x/8)^{28} + \epsilon \\ & |\epsilon| < 1 \times 10^{-8} \end{aligned}$$

#### 9.11.4 $0 < x \leq 8$

$$\begin{aligned} \text{kei } x = & -\ln(\tfrac{1}{2}x) \text{bei } x - \tfrac{1}{4}\pi \text{ber } x + 6.76454 \ 936(x/8)^2 \\ & - 142.91827 \ 687(x/8)^6 + 124.23569 \ 650(x/8)^{10} \\ & - 21.30060 \ 904(x/8)^{14} + 1.17509 \ 064(x/8)^{18} \\ & - .02695 \ 875(x/8)^{22} + .00029 \ 532(x/8)^{26} + \epsilon \\ & |\epsilon| < 3 \times 10^{-9} \end{aligned}$$

#### 9.11.5 $-8 \leq x \leq 8$

$$\begin{aligned} \text{ber}' x = & x[-4(x/8)^2 + 14.22222 \ 222(x/8)^6 \\ & - 6.06814 \ 810(x/8)^{10} + .66047 \ 849(x/8)^{14} \\ & - .02609 \ 253(x/8)^{18} + .00045 \ 957(x/8)^{22} \\ & - .00000 \ 394(x/8)^{26}] + \epsilon \\ & |\epsilon| < 2.1 \times 10^{-8} \end{aligned}$$

#### 9.11.6 $-8 \leq x \leq 8$

$$\begin{aligned} \text{bei}' x = & x[\tfrac{1}{2} - 10.66666 \ 666(x/8)^4 \\ & + 11.37777 \ 772(x/8)^8 - 2.31167 \ 514(x/8)^{12} \\ & + .14677 \ 204(x/8)^{16} - .00379 \ 386(x/8)^{20} \\ & + .00004 \ 609(x/8)^{24}] + \epsilon \\ & |\epsilon| < 7 \times 10^{-8} \end{aligned}$$

#### 9.11.7 $0 < x \leq 8$

$$\begin{aligned} \text{ker}' x = & -\ln(\tfrac{1}{2}x) \text{ber}' x - x^{-1} \text{ber } x + \tfrac{1}{4}\pi \text{bei}' x \\ & + x[-3.69113 \ 734(x/8)^2 + 21.42034 \ 017(x/8)^6 \\ & - 11.36433 \ 272(x/8)^{10} + 1.41384 \ 780(x/8)^{14} \\ & - .06136 \ 358(x/8)^{18} + .00116 \ 137(x/8)^{22} \\ & - .00001 \ 075(x/8)^{26}] + \epsilon \\ & |\epsilon| < 8 \times 10^{-8} \end{aligned}$$

**9.11.8**  $0 < x \leq 8$   
 $kei' x = -\ln(\frac{1}{2}x) bei' x - x^{-1} bei x - \frac{1}{4}\pi ber' x -$   
 $+x[.21139 217 - 13.39858 846(x/8)^4$   
 $+ 19.41182 758(x/8)^8 - 4.65950 823(x/8)^{12}$   
 $+ .33049 424(x/8)^{16} - .00926 707(x/8)^{20}$   
 $+ .00011 997(x/8)^{24}] + \epsilon$   
 $|\epsilon| < 7 \times 10^{-8}$

**9.11.9**  $8 \leq x < \infty$   
 $ker x + i kei x = f(x)(1 + \epsilon_1)$   
 $f(x) = \sqrt{\frac{\pi}{2x}} \exp\left[-\frac{1+i}{\sqrt{2}}x + \theta(-x)\right]$   
 $|\epsilon_1| < 1 \times 10^{-7}$

**9.11.10**  $8 \leq x < \infty$   
 $ber x + i bei x - \frac{i}{\pi}(ker x + i kei x) = g(x)(1 + \epsilon_2)$   
 $g(x) = \frac{1}{\sqrt{2\pi x}} \exp\left[\frac{1+i}{\sqrt{2}}x + \theta(x)\right]$   
 $|\epsilon_2| < 3 \times 10^{-7}$

where

**9.11.11**  
 $\theta(x) = (.00000 00 - .39269 91i)$   
 $+ (.01104 86 - .01104 85i)(8/x)$   
 $+ (.00000 00 - .00097 65i)(8/x)^2$   
 $+ (-.00009 06 - .00009 01i)(8/x)^3$   
 $+ (-.00002 52 + .00000 00i)(8/x)^4$   
 $+ (-.00000 34 + .00000 51i)(8/x)^5$   
 $+ (.00000 06 + .00000 19i)(8/x)^6$

**9.11.12**  $8 \leq x < \infty$   
 $ker' x + i kei' x = -f(x)\phi(-x)(1 + \epsilon_3)$   
 $|\epsilon_3| < 2 \times 10^{-7}$

**9.11.13**  $8 \leq x < \infty$   
 $ber' x + i bei' x - \frac{i}{\pi}(ker' x + i kei' x) = g(x)\phi(x)(1 + \epsilon_4)$   
 $|\epsilon_4| < 3 \times 10^{-7}$

where

**9.11.14**  
 $\phi(x) = (.70710 68 + .70710 68i)$   
 $+ (-.06250 01 - .00000 01i)(8/x)$   
 $+ (-.00138 13 + .00138 11i)(8/x)^2$   
 $+ (.00000 05 + .00024 52i)(8/x)^3$   
 $+ (.00003 46 + .00003 38i)(8/x)^4$   
 $+ (.00001 17 - .00000 24i)(8/x)^5$   
 $+ (.00000 16 - .00000 32i)(8/x)^6$

**Numerical Methods**

**9.12. Use and Extension of the Tables**

**Example 1.** To evaluate  $J_n(1.55)$ ,  $n=0, 1, 2, \dots$ , each to 5 decimals.

The recurrence relation

$$J_{n-1}(x) + J_{n+1}(x) = (2n/x)J_n(x)$$

can be used to compute  $J_0(x), J_1(x), J_2(x), \dots$ , successively provided that  $n < x$ , otherwise severe accumulation of rounding errors will occur. Since, however,  $J_n(x)$  is a decreasing function of  $n$  when  $n > x$ , recurrence can always be carried out in the direction of decreasing  $n$ .

Inspection of **Table 9.2** shows that  $J_n(1.55)$  vanishes to 5 decimals when  $n > 7$ . Taking arbitrary values zero for  $J_9$  and unity for  $J_8$ , we compute by recurrence the entries in the second column of the following table, rounding off to the nearest integer at each step.

| $n$ | <i>Trial values</i> | $J_n(1.55)$ |
|-----|---------------------|-------------|
| 9   | 0                   | .00000      |
| 8   | 1                   | .00000      |
| 7   | 10                  | .00003      |
| 6   | 89                  | .00028      |
| 5   | 679                 | .00211      |
| 4   | 4292                | .01331      |
| 3   | 21473               | .06661      |
| 2   | 78829               | .24453      |
| 1   | 181957              | .56442      |
| 0   | 155954              | .48376      |

We normalize the results by use of the equation **9.1.46**, namely

$$J_0(x) + 2J_2(x) + 2J_4(x) + \dots = 1$$

This yields the normalization factor

$$1/322376 = .00000 31019 7$$

and multiplying the trial values by this factor we obtain the required results, given in the third column. As a check we may verify the value of  $J_0(1.55)$  by interpolation in **Table 9.1**.

**Remarks.** (i) In this example it was possible to estimate immediately the value of  $n=N$ , say, at which to begin the recurrence. This may not always be the case and an arbitrary value of  $N$  may have to be taken. The number of correct significant figures in the final values is the same as the number of digits in the respective trial values. If the chosen  $N$  is too small the trial values will have too few digits and insufficient accuracy is obtained in the results. The calculation must then be repeated taking a higher value. On the other hand if  $N$  were too large unnecessary effort would be expended. This could be offset to some extent by discarding significant figures in the trial values which are in excess of the number of decimals required in  $J_n$ .

(ii) If we had required, say,  $J_0(1.55)$ ,  $J_1(1.55)$ , . . . ,  $J_{10}(1.55)$ , each to 5 significant figures, we would have found the values of  $J_{10}(1.55)$  and  $J_{11}(1.55)$  to 5 significant figures by interpolation in **Table 9.3** and then computed by recurrence  $J_9, J_8, \dots, J_0$ , no normalization being required.

Alternatively, we could begin the recurrence at a higher value of  $N$  and retain only 5 significant figures in the trial values for  $n \leq 10$ .

(iii) Exactly similar methods can be used to compute the modified Bessel function  $I_n(x)$  by means of the relations 9.6.26 and 9.6.36. If  $x$  is large, however, considerable cancellation will take place in using the latter equation, and it is preferable to normalize by means of 9.6.37.

**Example 2.** To evaluate  $Y_n(1.55)$ ,  $n=0, 1, 2, \dots, 10$ , each to 5 significant figures.

The recurrence relation

$$Y_{n-1}(x) + Y_{n+1}(x) = (2n/x)Y_n(x)$$

can be used to compute  $Y_n(x)$  in the direction of increasing  $n$  both for  $n < x$  and  $n > x$ , because in the latter event  $Y_n(x)$  is a numerically increasing function of  $n$ .

We therefore compute  $Y_0(1.55)$  and  $Y_1(1.55)$  by interpolation in **Table 9.1**, generate  $Y_2(1.55)$ ,  $Y_3(1.55)$ , . . . ,  $Y_{10}(1.55)$  by recurrence and check  $Y_{10}(1.55)$  by interpolation in **Table 9.3**.

|     |             |     |                           |
|-----|-------------|-----|---------------------------|
| $n$ | $Y_n(1.55)$ | $n$ | $Y_n(1.55)$               |
| 0   | +0.40225    | 6   | -1.9917 × 10 <sup>2</sup> |
| 1   | -0.37970    | 7   | -1.5100 × 10 <sup>3</sup> |
| 2   | -0.89218    | 8   | -1.3440 × 10 <sup>4</sup> |
| 3   | -1.9227     | 9   | -1.3722 × 10 <sup>5</sup> |
| 4   | -6.5505     | 10  | -1.5801 × 10 <sup>6</sup> |
| 5   | -31.886     |     |                           |

**Remarks.** (i) An alternative way of computing  $Y_0(x)$ , should  $J_0(x)$ ,  $J_2(x)$ ,  $J_4(x)$ , . . . , be available (see **Example 1**), is to use formula 9.1.89. The other starting value for the recurrence,  $Y_1(x)$ , can then be found from the Wronskian relation  $J_1(x)Y_0(x) - J_0(x)Y_1(x) = 2/(\pi x)$ . This is a convenient procedure for use with an automatic computer.

(ii) Similar methods can be used to compute the modified Bessel function  $K_n(x)$  by means of the recurrence relation 9.6.26 and the relation 9.6.54, except that if  $x$  is large severe cancellation will occur in the use of 9.6.54 and other methods for evaluating  $K_0(x)$  may be preferable, for example, use of the asymptotic expansion 9.7.2 or the polynomial approximation 9.8.6.

**Example 3.** To evaluate  $J_0(.36)$  and  $Y_0(.36)$  each to 5 decimals, using the multiplication theorem.

From 9.1.74 we have

$$\mathcal{C}_0(\lambda z) = \sum_{k=0}^{\infty} a_k \mathcal{C}_k(z), \text{ where } a_k = \frac{(-)^k (\lambda^2 - 1)^k (\frac{1}{2}z)^k}{k!}.$$

We take  $z=.4$ . Then  $\lambda=.9$ ,  $(\lambda^2 - 1)(\frac{1}{2}z) = -.038$ , and extracting the necessary values of  $J_k(.4)$  and  $Y_k(.4)$  from **Tables 9.1** and **9.2**, we compute the required results as follows:

|     |                            |                      |                      |
|-----|----------------------------|----------------------|----------------------|
| $k$ | $a_k$                      | $a_k J_k(.4)$        | $a_k Y_k(.4)$        |
| 0   | +1.0                       | + .96040             | - .60602             |
| 1   | +0.038                     | + .00745             | - .06767             |
| 2   | +0.7220 × 10 <sup>-3</sup> | + .00001             | - .00599             |
| 3   | +0.914 × 10 <sup>-5</sup>  |                      | - .00074             |
| 4   | +0.87 × 10 <sup>-7</sup>   |                      | - .00011             |
| 5   | +0.7 × 10 <sup>-9</sup>    |                      | - .00002             |
|     |                            | <hr/>                | <hr/>                |
|     |                            | $J_0(.36) = +.96786$ | $Y_0(.36) = -.68055$ |

**Remark.** This procedure is equivalent to interpolating by means of the Taylor series

$$\mathcal{C}_0(z+h) = \sum_{k=0}^{\infty} \frac{h^k}{k!} \mathcal{C}_0^{(k)}(z)$$

at  $z=.4$ , and expressing the derivatives  $\mathcal{C}_0^{(k)}(z)$  in terms of  $\mathcal{C}_k(z)$  by means of the recurrence relations and differential equation for the Bessel functions.

**Example 4.** To evaluate  $J_\nu(x)$ ,  $J'_\nu(x)$ ,  $Y_\nu(x)$  and  $Y'_\nu(x)$  for  $\nu=50$ ,  $x=75$ , each to 6 decimals.

We use the asymptotic expansions 9.3.35, 9.3.36, 9.3.43, and 9.3.44. Here  $z=x/\nu=3/2$ . From 9.3.39 we find

$$\frac{2}{3} (-\zeta)^{3/2} = \frac{1}{2} \sqrt{5} - \arccos \frac{2}{3} = +.2769653.$$

Hence

$$\zeta = -.5567724 \text{ and } \left(\frac{4\zeta}{1-\zeta^2}\right)^{1/4} = +1.155332.$$

Next,

$$\nu^{1/3} = 3.684031, \quad \nu^{2/3}\zeta = -7.556562.$$

Interpolating in **Table 10.11**, we find that

$$\begin{aligned} \text{Ai}(\nu^{2/3}\zeta) &= +.299953, & \text{Ai}'(\nu^{2/3}\zeta) &= +.451441, \\ \text{Bi}(\nu^{2/3}\zeta) &= -.160565, & \text{Bi}'(\nu^{2/3}\zeta) &= +.819542. \end{aligned}$$

As a check on the interpolation, we may verify that  $\text{Ai Bi}' - \text{Ai}' \text{Bi} = 1/\pi$ .

Interpolating in the table following **9.3.46** we obtain

$$b_0(\zeta) = +.0136, \quad c_0(\zeta) = +.1442.$$

The contributions of the terms involving  $a_1(\zeta)$  and  $d_1(\zeta)$  are negligible, and substituting in the asymptotic expansions we find that

$$\begin{aligned} J_{50}(75) &= +1.155332(50^{-1/3} \times .299953 \\ &\quad + 50^{-5/3} \times .451441 \times .0136) = +.094077, \end{aligned}$$

$$\begin{aligned} J'_{50}(75) &= -(4/3)(1.155332)^{-1}(50^{-4/3} \times .299953 \\ &\quad \times .1442 + 50^{-2/3} \times .451441) = -.038658, \end{aligned}$$

$$\begin{aligned} Y_{50}(75) &= -1.155332(-50^{-1/3} \times .160565 \\ &\quad + 50^{-5/3} \times .819542 \times .0136) = +.050335, \end{aligned}$$

$$\begin{aligned} Y'_{50}(75) &= +(4/3)(1.155332)^{-1}(-50^{-4/3} \times .160565 \\ &\quad \times .1442 + 50^{-2/3} \times .819542) = +.069543. \end{aligned}$$

As a check we may verify that

$$JY' - J'Y = 2/(75\pi).$$

**Remarks.** This example may also be computed using the Debye expansions **9.3.15**, **9.3.16**, **9.3.19**, and **9.3.20**. Four terms of each of these series are required, compared with two in the computations above. The closer the argument-order ratio is to unity, the less effective the Debye expansions become. In the neighborhood of unity the expansions **9.3.23**, **9.3.24**, **9.3.27**, and **9.3.28** will furnish results of moderate accuracy; for high-accuracy work the uniform expansions should again be used.

**Example 5.** To evaluate the 5th positive zero of  $J_{10}(x)$  and the corresponding value of  $J'_{10}(x)$ , each to 5 decimals.

We use the asymptotic expansions **9.5.22** and **9.5.23** setting  $\nu=10$ ,  $s=5$ . From **Table 10.11**

we find

$$a_5 = -7.944134, \quad \text{Ai}'(a_5) = +.947336.$$

Hence

$$\zeta = 10^{-2/3}a_5 = .21544347a_5 = -1.7115118.$$

Interpolating in the table following **9.5.26** we obtain

$$\begin{aligned} z(\zeta) &= +2.888631, & h(\zeta) &= +.98259, \\ f_1(\zeta) &= +.0107, & F_1(\zeta) &= -.001. \end{aligned}$$

The bounds given at the foot of the table show that the contributions of higher terms to the asymptotic series are negligible. Hence

$$j_{10,5} = 28.88631 + .00107 + \dots = 28.88738,$$

$$\begin{aligned} J'_{10}(j_{10,5}) &= -\frac{2}{10^{2/3}} \frac{.947336}{2.888631 \times .98259} \\ &\quad \times (1 - .00001 + \dots) = -.14381. \end{aligned}$$

**Example 6.** To evaluate the first root of  $J_0(x)Y_0(\lambda x) - Y_0(x)J_0(\lambda x) = 0$  for  $\lambda = \frac{3}{2}$  to 4 significant figures.

Let  $\alpha_\lambda^{(1)}$  denote the root. Direct interpolation in **Table 9.7** is impracticable owing to the divergence of the differences. Inspection of **9.5.28** suggests that a smoother function is  $(\lambda-1)\alpha_\lambda^{(1)}$ . Using **Table 9.7** we compute the following values

| $1/\lambda$ | $(\lambda-1)\alpha_\lambda^{(1)}$ | $\delta$ | $\delta^2$ |
|-------------|-----------------------------------|----------|------------|
| 0.4         | 3.110                             |          |            |
|             |                                   | +21      |            |
| 0.6         | 3.131                             |          | -12        |
|             |                                   | +9       |            |
| 0.8         | 3.140                             |          | -7         |
|             |                                   | +2       |            |
| 1.0         | 3.142( $\pi$ )                    |          |            |

Interpolating for  $1/\lambda = .667$ , we obtain  $(\lambda-1)\alpha_\lambda^{(1)} = 3.134$  and thence the required root  $\alpha_{1.5}^{(1)} = 6.268$ .

**Example 7.** To evaluate  $\text{ber}_n 1.55$ ,  $\text{bei}_n 1.55$ ,  $n=0, 1, 2, \dots$ , each to 5 decimals.

We use the recurrence relation

$$\begin{aligned} J_{n-1}(xe^{3\pi i/4}) + J_{n+1}(xe^{3\pi i/4}) \\ = -\frac{n\sqrt{2}}{x}(1+i)J_n(xe^{3\pi i/4}), \end{aligned}$$

taking arbitrary values zero for  $J_0(xe^{3\pi i/4})$  and  $1+0i$  for  $J_8(xe^{3\pi i/4})$  (see **Example 1**).

| $n$      | Real trial values | Imag. trial values | $\text{ber}_n x$ | $\text{bei}_n x$ |
|----------|-------------------|--------------------|------------------|------------------|
| 9        | 0                 | 0                  | .00000           | .00000           |
| 8        | +1                | 0                  | .00000           | .00000           |
| 7        | -7                | -7                 | -.00002          | -.00003          |
| 6        | -1                | +89                | -.00003          | +.00030          |
| 5        | +500              | -475               | +.00181          | -.00148          |
| 4        | -4447             | -203               | -.01494          | -.00180          |
| 3        | +14989            | +17446             | +.04614          | +.06258          |
| 2        | +11172            | -88578             | +.05994          | -.29580          |
| 1        | -197012           | +123804            | -.69531          | +.36781          |
| 0        | +281539           | +155373            | +.91004          | +.59461          |
| $\Sigma$ | +106734           | +207449            | +.30763          | +.72619          |

The values of  $\text{ber}_n x$  and  $\text{bei}_n x$  are computed by multiplication of the trial values by the normalizing factor

$$1/(294989 - 22011i) = (.337119 + .025155i) \times 10^{-5},$$

obtained from the relation

$$J_0(xe^{3\pi i/4}) + 2J_2(xe^{3\pi i/4}) + 2J_4(xe^{3\pi i/4}) + \dots = 1.$$

Adequate checks are furnished by interpolating in **Table 9.12** for  $\text{ber}$  1.55 and  $\text{bei}$  1.55, and the use of a simple sum check on the normalization.

Should  $\text{ker}_n x$  and  $\text{kei}_n x$  be required they can be computed by forward recurrence using formulas **9.9.14**, taking the required starting values for  $n=0$  and 1 from **Table 9.12** (see **Example 2**). If an independent check on the recurrence is required the asymptotic expansion **9.10.38** can be used.

## References

### Texts

- [9.1] E. E. Allen, Analytical approximations, *Math. Tables Aids Comp.* **8**, 240-241 (1954).
- [9.2] E. E. Allen, Polynomial approximations to some modified Bessel functions, *Math. Tables Aids Comp.* **10**, 162-164 (1956).
- [9.3] H. Bateman and R. C. Archibald, A guide to tables of Bessel functions, *Math. Tables Aids Comp.* **1**, 205-308 (1944).
- [9.4] W. G. Bickley, Bessel functions and formulae (Cambridge Univ. Press, Cambridge, England, 1953). This is a straight reprint of part of the preliminaries to [9.21].
- [9.5] H. S. Carslaw and J. C. Jaeger, Conduction of heat in solids (Oxford Univ. Press, London, England, 1947).
- [9.6] E. T. Copson, An introduction to the theory of functions of a complex variable (Oxford Univ. Press, London, England, 1935).
- [9.7] A. Erdélyi et al., Higher transcendental functions, vol 2, ch. 7 (McGraw-Hill Book Co., Inc., New York, N.Y., 1953).
- [9.8] E. T. Goodwin, Recurrence relations for cross-products of Bessel functions, *Quart. J. Mech. Appl. Math.* **2**, 72-74 (1949).
- [9.9] A. Gray, G. B. Mathews and T. M. MacRobert, A treatise on the theory of Bessel functions, 2d ed. (Macmillan and Co., Ltd., London, England; 1931).
- [9.10] W. Magnus and F. Oberhettinger, Formeln und Sätze für die speziellen Funktionen der mathematischen Physik, 2d ed. (Springer-Verlag; Berlin, Germany, 1948).
- [9.11] N. W. McLachlan, Bessel functions for engineers, 2d ed. (Clarendon Press, Oxford, England, 1955).
- [9.12] F. W. J. Olver, Some new asymptotic expansions for Bessel functions of large orders. *Proc. Cambridge Philos. Soc.* **48**, 414-427 (1952).

- [9.13] F. W. J. Olver, The asymptotic expansion of Bessel functions of large order. *Philos. Trans. Roy. Soc. London A* **247**, 328-368 (1954).
- [9.14] G. Petiau, La théorie des fonctions de Bessel (Centre National de la Recherche Scientifique, Paris, France, 1955).
- [9.15] G. N. Watson, A treatise on the theory of Bessel functions, 2d ed. (Cambridge Univ. Press, Cambridge, England, 1958).
- [9.16] R. Weyrich, Die Zylinderfunktionen und ihre Anwendungen (B. G. Teubner, Leipzig, Germany, 1937).
- [9.17] C. S. Whitehead, On a generalization of the functions  $\text{ber } x$ ,  $\text{bei } x$ ,  $\text{ker } x$ ,  $\text{kei } x$ . *Quart. J. Pure Appl. Math.* **42**, 316-342 (1911).
- [9.18] E. T. Whittaker and G. N. Watson, A course of modern analysis, 4th ed. (Cambridge Univ. Press, Cambridge, England, 1952).

### Tables

- [9.19] J. F. Bridge and S. W. Angrist, An extended table of roots of  $J'_n(x)Y'_n(\beta x) - J_n(\beta x)Y'_n(x) = 0$ , *Math. Comp.* **16**, 198-204 (1962).
- [9.20] British Association for the Advancement of Science, Bessel functions, Part I. Functions of orders zero and unity, *Mathematical Tables*, vol. VI (Cambridge Univ. Press, Cambridge, England, 1950).
- [9.21] British Association for the Advancement of Science, Bessel functions, Part II. Functions of positive integer order, *Mathematical Tables*, vol. X (Cambridge Univ. Press, Cambridge, England, 1952).
- [9.22] British Association for the Advancement of Science, Annual Report (J. R. Airey), 254 (1927).
- [9.23] E. Cambi, Eleven- and fifteen-place tables of Bessel functions of the first kind, to all significant orders (Dover Publications, Inc., New York, N.Y., 1948).



- [9.24] E. A. Chistova, *Tablitsy funktsii Besselya ot deistvitel'nogo argumenta i integralov ot nikh* (Izdat. Akad. Nauk SSSR, Moscow, U.S.S.R., 1958). (Table of Bessel functions with real argument and their integrals).
- [9.25] H. B. Dwight, *Tables of integrals and other mathematical data* (The Macmillan Co., New York, N.Y., 1957).  
This includes formulas for, and tables of Kelvin functions.
- [9.26] H. B. Dwight, Table of roots for natural frequencies in coaxial type cavities, *J. Math. Phys.* **27**, 84-89 (1948).  
This gives zeros of the functions **9.5.27** and **9.5.30** for  $n=0,1,2,3$ .
- [9.27] V. N. Faddeeva and M. K. Gavurin, *Tablitsy funktsii Besselia  $J_n(x)$  tselykh numerov ot 0 do 120* (Izdat. Akad. Nauk SSSR, Moscow, U.S.S.R., 1950). (Table of  $J_n(x)$  for orders 0 to 120).
- [9.28] L. Fox, A short table for Bessel functions of integer orders and large arguments. *Royal Society Shorter Mathematical Tables No. 3* (Cambridge Univ. Press, Cambridge, England, 1954).
- [9.29] E. T. Goodwin and J. Staton, Table of  $J_0(j_{0,n}r)$ , *Quart. J. Mech. Appl. Math.* **1**, 220-224 (1948).
- [9.30] Harvard Computation Laboratory, *Tables of the Bessel functions of the first kind of orders 0 through 135*, vols. 3-14 (Harvard Univ. Press, Cambridge, Mass., 1947-1951).
- [9.31] K. Hayashi, *Tafeln der Besselschen, Theta, Kugel- und anderer Funktionen* (Springer, Berlin, Germany, 1930).
- [9.32] E. Jahnke, F. Emde, and F. Lösch, *Tables of higher functions*, ch. IX, 6th ed. (McGraw-Hill Book Co., Inc., New York, N.Y., 1960).
- [9.33] L. N. Karmazina and E. A. Chistova, *Tablitsy funktsii Besselya ot mnimogo argumenta i integralov ot nikh* (Izdat. Akad. Nauk SSSR, Moscow, U.S.S.R., 1958). (Tables of Bessel functions with imaginary argument and their integrals).
- [9.34] Mathematical Tables Project, Table of  $f_n(x) = n!(\frac{1}{2}x)^{-n}J_n(x)$ . *J. Math. Phys.* **23**, 45-60 (1944).
- [9.35] National Bureau of Standards, *Table of the Bessel functions  $J_0(z)$  and  $J_1(z)$  for complex arguments*, 2d ed. (Columbia Univ. Press, New York, N.Y., 1947).
- [9.36] National Bureau of Standards, *Tables of the Bessel functions  $Y_0(z)$  and  $Y_1(z)$  for complex arguments* (Columbia Univ. Press, New York, N.Y., 1950).
- [9.37] National Physical Laboratory *Mathematical Tables*, vol. 5, Chebyshev series for mathematical functions, by C. W. Clenshaw (Her Majesty's Stationery Office, London, England, 1962).
- [9.38] National Physical Laboratory *Mathematical Tables*, vol. 6, *Tables for Bessel functions of moderate or large orders*, by F. W. J. Olver (Her Majesty's Stationery Office, London, England, 1962).
- [9.39] L. N. Nosova, *Tables of Thomson (Kelvin) functions and their first derivatives*, translated from the Russian by P. Basu (Pergamon Press, New York, N.Y., 1961).
- [9.40] *Royal Society Mathematical Tables*, vol. 7, *Bessel functions, Part III. Zeros and associated values*, edited by F. W. J. Olver (Cambridge Univ. Press, Cambridge, England, 1960).  
The introduction includes many formulas connected with zeros.
- [9.41] *Royal Society Mathematical Tables*, vol. 10, *Bessel functions, Part IV. Kelvin functions*, by A. Young and A. Kirk (Cambridge Univ. Press, Cambridge, England, 1963).  
The introduction includes many formulas for Kelvin functions.
- [9.42] W. Sibagaki, 0.01 % tables of modified Bessel functions, with the account of the methods used in the calculation (Baifukan, Tokyo, Japan, 1955).





# 10. Bessel Functions of Fractional Order

H. A. ANTOSIEWICZ<sup>1</sup>

## Contents

|  | Page |
|--|------|
| <b>Mathematical Properties</b> . . . . .   | 437  |
| 10.1. Spherical Bessel Functions . . . . .   | 437  |
| 10.2. Modified Spherical Bessel Functions . . . . .  | 443  |
| 10.3. Riccati-Bessel Functions . . . . .   | 445  |
| 10.4. Airy Functions . . . . .   | 446  |
| <b>Numerical Methods</b> . . . . .   | 452  |
| 10.5. Use and Extension of the Tables . . . . .  | 452  |
| <b>References</b> . . . . .  | 455  |
| <b>Table 10.1.</b> Spherical Bessel Functions—Orders 0, 1, and 2 ( $0 \leq x \leq 10$ ) .  | 457  |
| $j_n(x), y_n(x)$<br>$n=0, 1, 2; x=0(.1)5, 6-8S, x=5(.1)10, 5S$   |      |
| <b>Table 10.2.</b> Spherical Bessel Functions—Orders 3-10 ( $0 \leq x \leq 10$ ) . . .   | 459  |
| $j_n(x), y_n(x)$<br>$n=3(1)8; x=0(.1)10, 5S$<br>$x^{-n}j_n(x), x^{n+1}y_n(x)$<br>$n=9, 10; x=0(.1)10, 7-8S$  |      |
| <b>Table 10.3.</b> Spherical Bessel Functions—Orders 20 and 21 ( $0 \leq x \leq 25$ ) .  | 463  |
| $x^{-n} \exp(x^2/(4n+2))j_n(x)$<br>$x^{n+1} \exp(-x^2/(4n+2))y_n(x)$<br>$n=20, 21; x=0(.5)25, 6-8S$  |      |
| <b>Table 10.4.</b> Spherical Bessel Functions—Modulus and Phase—Orders<br>9, 10, 20 and 21 . . . . .   | 464  |
| $\sqrt{\frac{1}{2}\pi x}M_{n+\frac{1}{2}}(x), \theta_{n+\frac{1}{2}}(x) - x$ where<br>$j_n(x) = \sqrt{\frac{1}{2}\pi/x}M_{n+\frac{1}{2}}(x) \cos \theta_{n+\frac{1}{2}}(x)$<br>$y_n(x) = \sqrt{\frac{1}{2}\pi/x}M_{n+\frac{1}{2}}(x) \sin \theta_{n+\frac{1}{2}}(x)$<br>$n=9, 10; x^{-1}=.1(-.005)0, 8D$<br>$n=20, 21; x^{-1}=.04(-.002)0, 8D$ |      |
| <b>Table 10.5.</b> Spherical Bessel Functions—Various Orders ( $0 \leq n \leq 100$ ) .   | 465  |
| $j_n(x), y_n(x)$<br>$n=0(1)20, 30, 40, 50, 100$<br>$x=1, 2, 5, 10, 50, 100, 10S$   |      |
| <b>Table 10.6.</b> Zeros of Bessel Functions of Half-Integer Order ( $0 \leq n \leq 19$ ) .  | 467  |
| Zeros $j_{\nu, s}, y_{\nu, s}$ of $J_\nu(x), Y_\nu(x)$ and Values of $J'_\nu(j_{\nu, s}), Y'_\nu(y_{\nu, s})$<br>$\nu=n+\frac{1}{2}, n=0(1)19, 6-7D$   |      |
| <b>Table 10.7.</b> Zeros of the Derivative of Bessel Functions of Half-Integer<br>Order ( $0 \leq n \leq 19$ ) . . . . .   | 468  |
| Zeros $j'_{\nu, s}, y'_{\nu, s}$ of $J'_\nu(x), Y'_\nu(x)$ and Values of $J_\nu(j'_{\nu, s}), Y_\nu(y'_{\nu, s})$<br>$\nu=n+\frac{1}{2}, n=0(1)19, 6D$   |      |

<sup>1</sup> National Bureau of Standards. (Presently, University of Southern California.)

# 10. Bessel Functions of Fractional Order

## Mathematical Properties

### 10.1. Spherical Bessel Functions

#### Definitions

#### Differential Equation

##### 10.1.1

$$z^2 w'' + 2zw' + [z^2 - n(n+1)]w = 0$$

( $n=0, \pm 1, \pm 2, \dots$ )

Particular solutions are the *Spherical Bessel functions of the first kind*

$$j_n(z) = \sqrt{\frac{1}{2}\pi/z} J_{n+\frac{1}{2}}(z),$$

the *Spherical Bessel functions of the second kind*

$$y_n(z) = \sqrt{\frac{1}{2}\pi/z} Y_{n+\frac{1}{2}}(z),$$

and the *Spherical Bessel functions of the third kind*

$$h_n^{(1)}(z) = j_n(z) + iy_n(z) = \sqrt{\frac{1}{2}\pi/z} H_{n+\frac{1}{2}}^{(1)}(z),$$

$$h_n^{(2)}(z) = j_n(z) - iy_n(z) = \sqrt{\frac{1}{2}\pi/z} H_{n+\frac{1}{2}}^{(2)}(z).$$

The pairs  $j_n(z)$ ,  $y_n(z)$  and  $h_n^{(1)}(z)$ ,  $h_n^{(2)}(z)$  are linearly independent solutions for every  $n$ . For general properties see the remarks after 9.1.1.

#### Ascending Series (See 9.1.2, 9.1.10)

##### 10.1.2

$$j_n(z) = \frac{z^n}{1 \cdot 3 \cdot 5 \dots (2n+1)} \left\{ 1 - \frac{\frac{1}{2}z^2}{1!(2n+3)} + \frac{(\frac{1}{2}z^2)^2}{2!(2n+3)(2n+5)} - \dots \right\}$$

##### 10.1.3

$$y_n(z) = -\frac{1 \cdot 3 \cdot 5 \dots (2n-1)}{z^{n+1}} \left\{ 1 - \frac{\frac{1}{2}z^2}{1!(1-2n)} + \frac{(\frac{1}{2}z^2)^2}{2!(1-2n)(3-2n)} - \dots \right\}$$

( $n=0, 1, 2, \dots$ )

#### Limiting Values as $z \rightarrow 0$

##### 10.1.4

$$z^{-n} j_n(z) \rightarrow \frac{1}{1 \cdot 3 \cdot 5 \dots (2n+1)}$$

##### 10.1.5

$$z^{n+1} y_n(z) \rightarrow -1 \cdot 3 \cdot 5 \dots (2n-1) \quad (n=0, 1, 2, \dots)$$

#### Wronskians

##### 10.1.6

$$W\{j_n(z), y_n(z)\} = z^{-2}$$

##### 10.1.7

$$W\{h_n^{(1)}(z), h_n^{(2)}(z)\} = -2iz^{-2} \quad (n=0, 1, 2, \dots)$$

#### Representations by Elementary Functions

##### 10.1.8

$$j_n(z) = z^{-1} [P(n+\frac{1}{2}, z) \sin(z - \frac{1}{2}n\pi) + Q(n+\frac{1}{2}, z) \cos(z - \frac{1}{2}n\pi)]$$

##### 10.1.9

$$y_n(z) = (-1)^{n+1} z^{-1} [P(n+\frac{1}{2}, z) \cos(z + \frac{1}{2}n\pi) - Q(n+\frac{1}{2}, z) \sin(z + \frac{1}{2}n\pi)]$$

$$P(n+\frac{1}{2}, z) = 1 - \frac{(n+2)!}{2! \Gamma(n-1)} (2z)^{-2} + \frac{(n+4)!}{4! \Gamma(n-3)} (2z)^{-4} - \dots$$

$$= \sum_0^{[n]} (-1)^k (n+\frac{1}{2}, 2k) (2z)^{-2k}$$

$$Q(n+\frac{1}{2}, z) = \frac{(n+1)!}{1! \Gamma(n)} (2z)^{-1} - \frac{(n+3)!}{3! \Gamma(n-2)} (2z)^{-3} + \frac{(n+5)!}{5! \Gamma(n-4)} (2z)^{-5} - \dots$$

$$= \sum_0^{[n-1]} (-1)^k (n+\frac{1}{2}, 2k+1) (2z)^{-2k-1}$$

( $n=0, 1, 2, \dots$ )

$$(n+\frac{1}{2}, k) = \frac{(n+k)!}{k! \Gamma(n-k+1)}$$

| $n \backslash k$ | 1  | 2   | 3    | 4     | 5     |
|------------------|----|-----|------|-------|-------|
| 1                | 2  |     |      |       |       |
| 2                | 6  | 12  |      |       |       |
| 3                | 12 | 60  | 120  |       |       |
| 4                | 20 | 180 | 840  | 1680  |       |
| 5                | 30 | 420 | 3360 | 15120 | 30240 |

10.1.10

$$j_n(z) = f_n(z) \sin z + (-1)^{n+1} f_{-n-1}(z) \cos z$$

$$f_0(z) = z^{-1}, \quad f_1(z) = z^{-2}$$

$$f_{n-1}(z) + f_{n+1}(z) = (2n+1)z^{-1}f_n(z)$$

( $n=0, \pm 1, \pm 2, \dots$ )

The Functions  $j_n(z)$ ,  $y_n(z)$  for  $n=0, 1, 2$

10.1.11

$$j_0(z) = \frac{\sin z}{z}$$

$$j_1(z) = \frac{\sin z}{z^2} - \frac{\cos z}{z}$$

$$j_2(z) = \left(\frac{3}{z^3} - \frac{1}{z}\right) \sin z - \frac{3}{z^2} \cos z$$

10.1.12

$$y_0(z) = -j_{-1}(z) = -\frac{\cos z}{z}$$

$$y_1(z) = j_{-2}(z) = -\frac{\cos z}{z^2} - \frac{\sin z}{z}$$

$$y_2(z) = -j_{-3}(z) = \left(-\frac{3}{z^3} + \frac{1}{z}\right) \cos z - \frac{3}{z^2} \sin z$$

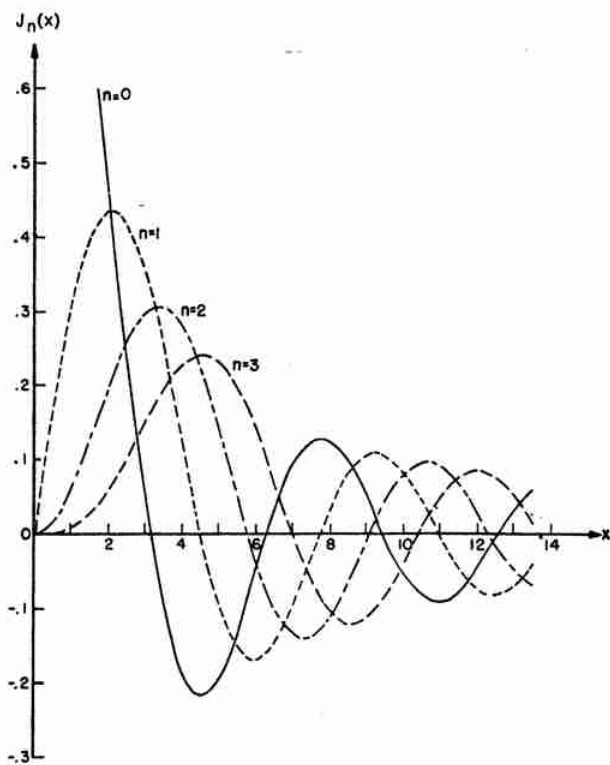

FIGURE 10.1.  $j_n(x)$ .  $n=0(1)3$ .

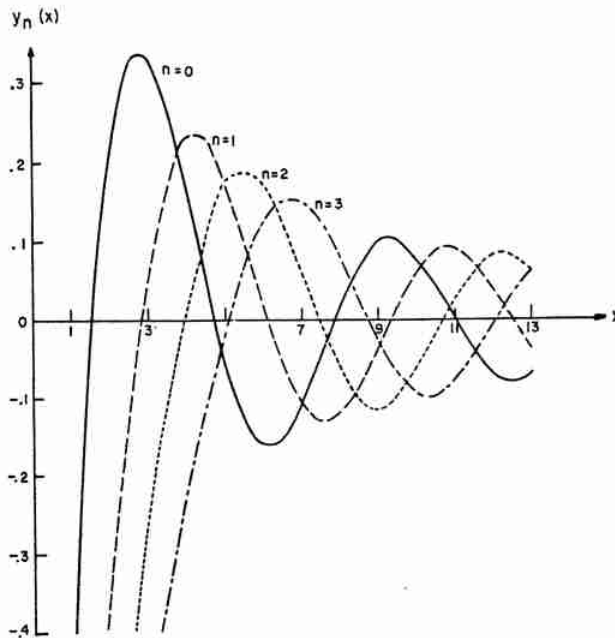

FIGURE 10.2.  $y_n(x)$ .  $n=0(1)3$ .

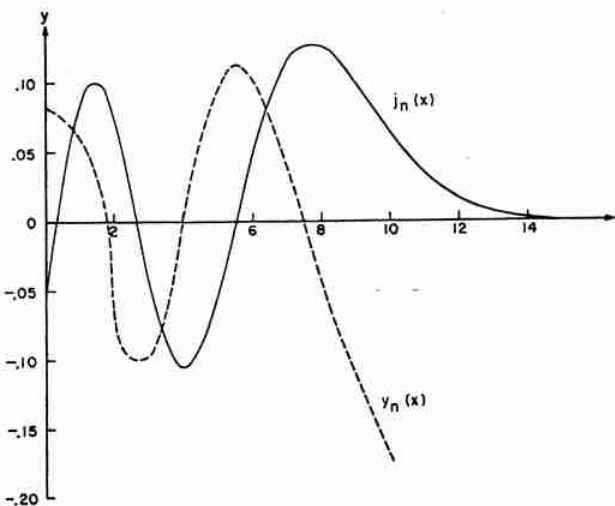

FIGURE 10.3.  $j_n(x)$ ,  $y_n(x)$ .  $x=10$ .

Poisson's Integral and Gegenbauer's Generalization

10.1.13 
$$j_n(z) = \frac{z^n}{2^{n+1}n!} \int_0^\pi \cos(z \cos \theta) \sin^{2n+1} \theta \, d\theta$$
  
(See 9.1.20.)

10.1.14

$$= \frac{1}{2} (-i)^n \int_0^\pi e^{iz \cos \theta} P_n(\cos \theta) \sin \theta \, d\theta$$

( $n=0, 1, 2, \dots$ )

\*See page II.

**Spherical Bessel Functions of the Second and Third Kind**

**10.1.15**

$$y_n(z) = (-1)^{n+1} j_{-n-1}(z) \quad (n=0, \pm 1, \pm 2, \dots)$$

**10.1.16**

$$h_n^{(1)}(z) = i^{-n-1} z^{-1} e^{iz} \sum_0^n (n + \frac{1}{2}, k) (-2iz)^{-k}$$

**10.1.17**

$$h_n^{(2)}(z) = i^{n+1} z^{-1} e^{-iz} \sum_0^n (n + \frac{1}{2}, k) (2iz)^{-k} \quad *$$

**10.1.18**

$$h_{-n-1}^{(1)}(z) = i(-1)^n h_n^{(1)}(z)$$

$$h_{-n-1}^{(2)}(z) = -i(-1)^n h_n^{(2)}(z) \quad (n=0, 1, 2, \dots)$$

**Elementary Properties  
Recurrence Relations**

$$f_n(z) : j_n(z), y_n(z), h_n^{(1)}(z), h_n^{(2)}(z)$$

$$(n=0, \pm 1, \pm 2, \dots)$$

**10.1.19**  $f_{n-1}(z) + f_{n+1}(z) = (2n+1)z^{-1}f_n(z)$

**10.1.20**  $nf_{n-1}(z) - (n+1)f_{n+1}(z) = (2n+1) \frac{d}{dz} f_n(z)$

**10.1.21**  $\frac{n+1}{z} f_n(z) + \frac{d}{dz} f_n(z) = f_{n-1}(z)$

(See 10.1.23.)

**10.1.22**  $\frac{n}{z} f_n(z) - \frac{d}{dz} f_n(z) = f_{n+1}(z)$

(See 10.1.24.)

**Differentiation Formulas**

$$f_n(z) : j_n(z), y_n(z), h_n^{(1)}(z), h_n^{(2)}(z)$$

$$(n=0, \pm 1, \pm 2, \dots)$$

**10.1.23**  $(\frac{1}{z} \frac{d}{dz})^m [z^{n+1} f_n(z)] = z^{n-m+1} f_{n-m}(z)$

**10.1.24**  $(\frac{1}{z} \frac{d}{dz})^m [z^{-n} f_n(z)] = (-1)^m z^{-n-m} f_{n+m}(z)$

$$(m=1, 2, 3, \dots)$$

**Rayleigh's Formulas**

**10.1.25**

$$j_n(z) = z^n \left( -\frac{1}{z} \frac{d}{dz} \right)^n \frac{\sin z}{z}$$

**10.1.26**

$$y_n(z) = -z^n \left( -\frac{1}{z} \frac{d}{dz} \right)^n \frac{\cos z}{z} \quad (n=0, 1, 2, \dots)$$

**Modulus and Phase**

$$j_n(z) = \sqrt{\frac{1}{2}\pi/z} M_{n+\frac{1}{2}}(z) \cos \theta_{n+\frac{1}{2}}(z),$$

$$y_n(z) = \sqrt{\frac{1}{2}\pi/z} M_{n+\frac{1}{2}}(z) \sin \theta_{n+\frac{1}{2}}(z)$$

(See 9.2.17.)

**10.1.27**

$$(\frac{1}{2}\pi/z) M_{n+\frac{1}{2}}^2(z) = \frac{1}{z^2} \sum_0^n \frac{(2n-k)!(2n-2k)!}{k![(n-k)!]^2} (2z)^{2k-2n}$$

(See 9.2.28.)

**10.1.28**  $(\frac{1}{2}\pi/z) M_{1/2}^2(z) = j_0^2(z) + y_0^2(z) = z^{-2}$

**10.1.29**

$$(\frac{1}{2}\pi/z) M_{3/2}^2(z) = j_1^2(z) + y_1^2(z) = z^{-2} + z^{-4}$$

**10.1.30**

$$(\frac{1}{2}\pi/z) M_{5/2}^2(z) = j_2^2(z) + y_2^2(z) = z^{-2} + 3z^{-4} + 9z^{-6}$$

**Cross Products**

**10.1.31**  $j_n(z)y_{n-1}(z) - j_{n-1}(z)y_n(z) = z^{-2}$

**10.1.32**

$$j_{n+1}(z)y_{n-1}(z) - j_{n-1}(z)y_{n+1}(z) = (2n+1)z^{-3}$$

**10.1.33**

$$j_0(z)j_n(z) + y_0(z)y_n(z)$$

$$= z^{-2} \sum_0^{[n]} (-1)^k 2^{n-2k} \binom{k+\frac{1}{2}}{n-2k} \binom{n-k}{k} z^{2k-n}$$

$$(n=0, 1, 2, \dots)$$

**Analytic Continuation**

**10.1.34**  $j_n(ze^{m\pi i}) = e^{mn\pi i} j_n(z)$

**10.1.35**  $y_n(ze^{m\pi i}) = (-1)^m e^{mn\pi i} y_n(z)$

**10.1.36**  $h_n^{(1)}(ze^{(2m+1)\pi i}) = (-1)^n h_n^{(2)}(z)$

**10.1.37**  $h_n^{(2)}(ze^{(2m+1)\pi i}) = (-1)^n h_n^{(1)}(z)$

**10.1.38**  $h_n^{(1)}(ze^{2m\pi i}) = h_n^{(1)}(z)$

$$(l=1, 2; m, n=0, 1, 2, \dots)$$

**Generating Functions**

**10.1.39**

$$\frac{1}{z} \sin \sqrt{z^2+2zt} = \sum_0^\infty \frac{(-t)^n}{n!} y_{n-1}(z) \quad (2|t| < |z|)$$

**10.1.40**  $\frac{1}{z} \cos \sqrt{z^2-2zt} = \sum_0^\infty \frac{t^n}{n!} j_{n-1}(z)$

\*See page 11

## Derivatives With Respect to Order

10.1.41

$$\left[ \frac{\partial}{\partial \nu} j_\nu(x) \right]_{\nu=0} = (\frac{1}{2}\pi/x) \{ \text{Ci}(2x) \sin x - \text{Si}(2x) \cos x \}$$

10.1.42

$$\left[ \frac{\partial}{\partial \nu} j_\nu(x) \right]_{\nu=-1} = (\frac{1}{2}\pi/x) \{ \text{Ci}(2x) \cos x + \text{Si}(2x) \sin x \}$$

10.1.43

$$\left[ \frac{\partial}{\partial \nu} y_\nu(x) \right]_{\nu=0} = (\frac{1}{2}\pi/x) \{ \text{Ci}(2x) \cos x + [\text{Si}(2x) - \pi] \sin x \}$$

10.1.44

$$\left[ \frac{\partial}{\partial \nu} y_\nu(x) \right]_{\nu=-1} = (\frac{1}{2}\pi/x) \{ \text{Ci}(2x) \sin x - [\text{Si}(2x) - \pi] \cos x \}$$

## Addition Theorems and Degenerate Forms

$r, \rho, \theta, \lambda$  arbitrary complex;  $R = \sqrt{(r^2 + \rho^2 - 2r\rho \cos \theta)}$

$$10.1.45 \quad \frac{\sin \lambda R}{\lambda R} = \sum_0^\infty (2n+1) j_n(\lambda r) j_n(\lambda \rho) P_n(\cos \theta)$$

$$*10.1.46 \quad -\frac{\cos \lambda R}{\lambda R} = \sum_0^\infty (2n+1) j_n(\lambda r) y_n(\lambda \rho) P_n(\cos \theta)$$

$|r e^{\pm i\theta}| < |\rho|$

$$10.1.47 \quad e^{iz \cos \theta} = \sum_0^\infty (2n+1) e^{i n \pi t} j_n(z) P_n(\cos \theta)$$

10.1.48

$$J_0(z \sin \theta) = \sum_0^\infty (4n+1) \frac{(2n)!}{2^{2n}(n!)^2} j_{2n}(z) P_{2n}(\cos \theta)$$

## Duplication Formula

10.1.49

$$j_n(2z) =$$

$$* \quad -n! z^{n+1} \sum_0^n \frac{2n-2k+1}{k!(2n-k+1)!} j_{n-k}(z) y_{n-k}(z)$$

Some Infinite Series Involving  $j_n^2(z)$ 

$$10.1.50 \quad \sum_0^\infty (2n+1) j_n^2(z) = 1$$

$$10.1.51 \quad \sum_0^\infty (-1)^n (2n+1) j_n^2(z) = \frac{\sin 2z}{2z}$$

$$10.1.52 \quad \sum_0^\infty j_n^2(z) = \frac{\text{Si}(2z)}{2z}$$

\*See page II.

## Fresnel Integrals

10.1.53

$$C(\sqrt{2x/\pi}) = \frac{1}{2} \int_0^x J_{-1/2}(t) dt$$

$$= \sqrt{2} [\cos \frac{1}{2}x \sum_0^\infty (-1)^n J_{2n+1/2}(\frac{1}{2}x) + \sin \frac{1}{2}x \sum_0^\infty (-1)^n J_{2n+3/2}(\frac{1}{2}x)]$$

10.1.54

$$S(\sqrt{2x/\pi}) = \frac{1}{2} \int_0^x J_{1/2}(t) dt$$

$$= \sqrt{2} [\sin \frac{1}{2}x \sum_0^\infty (-1)^n J_{2n+1}(\frac{1}{2}x) - \cos \frac{1}{2}x \sum_0^\infty (-1)^n J_{2n+3/2}(\frac{1}{2}x)].$$

(See also 11.1.1, 11.1.2.)

## Zeros and Their Asymptotic Expansions

The zeros of  $j_n(x)$  and  $y_n(x)$  are the same as the zeros of  $J_{n+1/2}(x)$  and  $Y_{n+1/2}(x)$  and the formulas for  $j_{\nu,s}$  and  $y_{\nu,s}$  given in 9.5 are applicable with  $\nu = n + \frac{1}{2}$ . There are, however, no simple relations connecting the zeros of the derivatives. Accordingly, we now give formulas for  $a'_{n,s}$ ,  $b'_{n,s}$ , the  $s$ -th positive zero of  $j'_n(z)$ ,  $y'_n(z)$ , respectively;  $z=0$  is counted as the first zero of  $j'_0(z)$ .

(Tables of  $a'_{n,s}$ ,  $b'_{n,s}$ ,  $j_n(a'_{n,s})$ ,  $y_n(b'_{n,s})$  are given in [10.31].)

## Elementary Relations

$$f_n(z) = j_n(z) \cos \pi t + y_n(z) \sin \pi t$$

( $t$  a real parameter,  $0 \leq t \leq 1$ )

If  $\tau_n$  is a zero of  $f'_n(z)$  then

$$10.1.55 \quad f_n(\tau_n) = [\tau_n/(n+1)] f_{n-1}(\tau_n)$$

(See 10.1.21.)

$$10.1.56 \quad = (\tau_n/n) f_{n+1}(\tau_n)$$

(See 10.1.22.)

$$10.1.57 \quad = \left\{ \frac{1}{\pi} [\tau_n^2 - n(n+1)] \frac{d\tau_n}{d\tau} \right\}^{-1}$$

McMahon's Expansions for  $n$  Fixed and  $s$  Large

10.1.58

$$a'_{n,s}, b'_{n,s} \sim \beta - (\mu + 7)(8\beta)^{-1} - \frac{4}{3}(7\mu^2 + 154\mu + 95)(8\beta)^{-3} - \frac{32}{15}(85\mu^3 + 3535\mu^2 + 3561\mu + 6133)(8\beta)^{-5} - \frac{64}{105}(6949\mu^4 + 474908\mu^3 + 330638\mu^2 + 9046780\mu - 5075147)(8\beta)^{-7} - \dots$$

$$\beta = \pi(s + \frac{1}{2}n - \frac{1}{2}) \text{ for } a'_{n,s}, \beta = \pi(s + \frac{1}{2}n) \text{ for } b'_{n,s};$$

$$\mu = (2n + 1)^2$$

Asymptotic Expansions of Zeros and Associated Values for  $n$  Large

10.1.59

$$a'_{n,1} \sim (n + \frac{1}{2}) + .8086165(n + \frac{1}{2})^{1/3} - .236680(n + \frac{1}{2})^{-1/3} - .20736(n + \frac{1}{2})^{-1} + .0233(n + \frac{1}{2})^{-5/3} + \dots$$

10.1.60

$$b'_{n,1} \sim (n + \frac{1}{2}) + 1.8210980(n + \frac{1}{2})^{1/3} + .802728(n + \frac{1}{2})^{-1/3} - .11740(n + \frac{1}{2})^{-1} + .0249(n + \frac{1}{2})^{-5/3} + \dots$$

10.1.61

$$j_n(a'_{n,1}) \sim .8458430(n + \frac{1}{2})^{-5/6} \{ 1 - .566032(n + \frac{1}{2})^{-2/3} + .38081(n + \frac{1}{2})^{-4/3} - .2203(n + \frac{1}{2})^{-2} + \dots \}$$

10.1.62

$$y_n(b'_{n,1}) \sim .7183921(n + \frac{1}{2})^{-5/6} \{ 1 - 1.274769(n + \frac{1}{2})^{-2/3} + 1.23038(n + \frac{1}{2})^{-4/3} - 1.0070(n + \frac{1}{2})^{-2} + \dots \}$$

See [10.31] for corresponding expansions for  $s=2, 3$ .

Uniform Asymptotic Expansions of Zeros and Associated Values for  $n$  Large

10.1.63

$$a'_{n,s} \sim (n + \frac{1}{2}) \{ z[(n + \frac{1}{2})^{-2/3} a'_s] + \sum_{k=1}^{\infty} h_k [(n + \frac{1}{2})^{-2/3} a'_s] (n + \frac{1}{2})^{-2k} \}$$

10.1.64

$$b'_{n,s} \sim (n + \frac{1}{2}) \{ z[(n + \frac{1}{2})^{-2/3} b'_s] + \sum_{k=1}^{\infty} h_k [(n + \frac{1}{2})^{-2/3} b'_s] (n + \frac{1}{2})^{-2k} \}$$

10.1.65

$$j_n(a'_{n,s}) \sim \sqrt{\frac{1}{2}\pi} \text{Ai}(a'_s) (n + \frac{1}{2})^{-5/6} h[(n + \frac{1}{2})^{-2/3} a'_s] \{ z[(n + \frac{1}{2})^{-2/3} a'_s] \}^{-1/2} \{ 1 + \sum_{k=1}^{\infty} H_k [(n + \frac{1}{2})^{-2/3} a'_s] (n + \frac{1}{2})^{-2k} \}$$

10.1.66

$$y_n(b'_{n,s}) \sim -\sqrt{\frac{1}{2}\pi} \text{Bi}(b'_s) (n + \frac{1}{2})^{-5/6} h[(n + \frac{1}{2})^{-2/3} b'_s] \{ z[(n + \frac{1}{2})^{-2/3} b'_s] \}^{-1/2} \{ 1 + \sum_{k=1}^{\infty} H_k [(n + \frac{1}{2})^{-2/3} b'_s] (n + \frac{1}{2})^{-2k} \}$$

$h(\xi), z(\xi)$  are defined as in 9.5.26, 9.3.38, 9.3.39.  $a'_s, b'_s$   $s$ -th (negative) real zero of  $\text{Ai}'(z), \text{Bi}'(z)$  (see 10.4.95, 10.4.99.)

Complex Zeros of  $h_n^{(1)}(z), h_n^{(1)'}(z)$

$h_n^{(1)}(z)$  and  $h_n^{(1)}(ze^{2m\pi i})$ ,  $m$  any integer, have the same zeros.

$h_n^{(1)}(z)$  has  $n$  zeros, symmetrically distributed with respect to the imaginary axis and lying approximately on the finite arc joining  $z = -n$  and  $z = n$  shown in Figure 9.6. If  $n$  is odd, one zero lies on the imaginary axis.

$h_n^{(1)'}(z)$  has  $n + 1$  zeros lying approximately on the same curve. If  $n$  is even, one zero lies on the imaginary axis.

10.2. Modified Spherical Bessel Functions

Definitions

Differential Equation

10.2.1

$$z^2 w'' + 2zw' - [z^2 + n(n+1)]w = 0$$

( $n=0, \pm 1, \pm 2, \dots$ )

Particular solutions are the *Modified Spherical Bessel functions of the first kind*,

10.2.2

$$\begin{aligned} \sqrt{\frac{1}{2}\pi/z} I_{n+\frac{1}{2}}(z) &= e^{-n\pi i/2} j_n(ze^{\pi i/2}) & (-\pi < \arg z \leq \frac{1}{2}\pi) \\ &= e^{3n\pi i/2} j_n(ze^{-3\pi i/2}) & (\frac{1}{2}\pi < \arg z \leq \pi) \end{aligned}$$

of the second kind,

10.2.3

$$\begin{aligned} \sqrt{\frac{1}{2}\pi/z} I_{-n-\frac{1}{2}}(z) &= e^{3(n+1)\pi i/2} y_n(ze^{\pi i/2}) & (-\pi < \arg z \leq \frac{1}{2}\pi) \\ &= e^{-(n+1)\pi i/2} y_n(ze^{-3\pi i/2}) & (\frac{1}{2}\pi < \arg z \leq \pi) \end{aligned}$$

of the third kind,

10.2.4

$$\sqrt{\frac{1}{2}\pi/z} K_{n+\frac{1}{2}}(z) = \frac{1}{2}\pi (-1)^{n+1} \sqrt{\frac{1}{2}\pi/z} [I_{n+\frac{1}{2}}(z) - I_{-n-\frac{1}{2}}(z)]$$

The pairs

$$\sqrt{\frac{1}{2}\pi/z} I_{n+\frac{1}{2}}(z), \sqrt{\frac{1}{2}\pi/z} I_{-n-\frac{1}{2}}(z)$$

and

$$\sqrt{\frac{1}{2}\pi/z} I_{n+\frac{1}{2}}(z), \sqrt{\frac{1}{2}\pi/z} K_{n+\frac{1}{2}}(z)$$

are linearly independent solutions for every  $n$ .

Most properties of the Modified Spherical Bessel functions can be derived from those of the Spherical Bessel functions by use of the above relations.

Ascending Series

10.2.5

$$\begin{aligned} \sqrt{\frac{1}{2}\pi/z} I_{n+\frac{1}{2}}(z) &= \frac{z^n}{1 \cdot 3 \cdot 5 \dots (2n+1)} \\ &\left\{ 1 + \frac{\frac{1}{2}z^2}{1!(2n+3)} + \frac{(\frac{1}{2}z^2)^2}{2!(2n+3)(2n+5)} + \dots \right\} \end{aligned}$$

10.2.6

$$\begin{aligned} \sqrt{\frac{1}{2}\pi/z} I_{-n-\frac{1}{2}}(z) &= \frac{1 \cdot 3 \cdot 5 \dots (2n-1)}{(-1)^n z^{n+1}} \\ &\left\{ 1 + \frac{\frac{1}{2}z^2}{1!(1-2n)} + \frac{(\frac{1}{2}z^2)^2}{2!(1-2n)(3-2n)} + \dots \right\} \end{aligned}$$

( $n=0, 1, 2, \dots$ )

Wronskians

10.2.7

$$W\{\sqrt{\frac{1}{2}\pi/z} I_{n+\frac{1}{2}}(z), \sqrt{\frac{1}{2}\pi/z} I_{-n-\frac{1}{2}}(z)\} = (-1)^{n+1} z^{-2}$$

10.2.8

$$W\{\sqrt{\frac{1}{2}\pi/z} I_{n+\frac{1}{2}}(z), \sqrt{\frac{1}{2}\pi/z} K_{n+\frac{1}{2}}(z)\} = -\frac{1}{2}\pi z^{-2}$$

Representations by Elementary Functions

10.2.9

$$\begin{aligned} \sqrt{\frac{1}{2}\pi/z} I_{n+\frac{1}{2}}(z) &= (2z)^{-1} [R(n+\frac{1}{2}, -z) e^z \\ &\quad - (-1)^n R(n+\frac{1}{2}, z) e^{-z}] \end{aligned}$$

10.2.10

$$\begin{aligned} \sqrt{\frac{1}{2}\pi/z} I_{-n-\frac{1}{2}}(z) &= (2z)^{-1} [R(n+\frac{1}{2}, -z) e^z \\ &\quad + (-1)^n R(n+\frac{1}{2}, z) e^{-z}] \end{aligned}$$

10.2.11

$$\begin{aligned} R(n+\frac{1}{2}, z) &= 1 + \frac{(n+1)!}{1! \Gamma(n)} (2z)^{-1} \\ &\quad + \frac{(n+2)!}{2! \Gamma(n-1)} (2z)^{-2} + \dots \\ &= \sum_0^n (n+\frac{1}{2}, k) (2z)^{-k} \end{aligned}$$

( $n=0, 1, 2, \dots$ )

(See 10.1.9.)

10.2.12

$$\begin{aligned} \sqrt{\frac{1}{2}\pi/z} I_{n+\frac{1}{2}}(z) &= g_n(z) \sinh z + g_{-n-1}(z) \cosh z \\ g_0(z) &= z^{-1}, g_1(z) = -z^{-2} \\ g_{n-1}(z) - g_{n+1}(z) &= (2n+1) z^{-1} g_n(z) \end{aligned}$$

( $n=0, \pm 1, \pm 2, \dots$ )

The Functions  $\sqrt{\frac{1}{2}\pi/z} I_{\pm(n+\frac{1}{2})}(z)$ ,  $n=0, 1, 2$

10.2.13

$$\begin{aligned} \sqrt{\frac{1}{2}\pi/z} I_{1/2}(z) &= \frac{\sinh z}{z} \\ \sqrt{\frac{1}{2}\pi/z} I_{3/2}(z) &= -\frac{\sinh z}{z^2} + \frac{\cosh z}{z} \\ \sqrt{\frac{1}{2}\pi/z} I_{5/2}(z) &= \left(\frac{3}{z^3} + \frac{1}{z}\right) \sinh z - \frac{3}{z^2} \cosh z \end{aligned}$$

10.2.14

$$\begin{aligned} \sqrt{\frac{1}{2}\pi/z} I_{-1/2}(z) &= \frac{\cosh z}{z} \\ \sqrt{\frac{1}{2}\pi/z} I_{-3/2}(z) &= \frac{\sinh z}{z} - \frac{\cosh z}{z^2} \\ \sqrt{\frac{1}{2}\pi/z} I_{-5/2}(z) &= -\frac{3}{z^2} \sinh z + \left(\frac{3}{z^3} + \frac{1}{z}\right) \cosh z \end{aligned}$$



Modified Spherical Bessel Functions of the Third Kind

10.2.15

$$\begin{aligned} \sqrt{\frac{1}{2}\pi/z}K_{n+\frac{1}{2}}(z) &= \frac{1}{2}\pi i e^{(n+1)\pi i/2} h_n^{(1)}(ze^{\frac{1}{2}\pi i}) \\ &\quad (-\pi < \arg z \leq \frac{1}{2}\pi) \\ &= -\frac{1}{2}\pi i e^{-(n+1)\pi i/2} h_n^{(2)}(ze^{-\frac{1}{2}\pi i}) \\ &\quad (\frac{1}{2}\pi < \arg z \leq \pi) \\ &= (\frac{1}{2}\pi/z) e^{-z} \sum_0^n (n+\frac{1}{2}, k) (2z)^{-k} \end{aligned}$$

10.2.16

$$K_{n+\frac{1}{2}}(z) = K_{-n-\frac{1}{2}}(z) \quad (n=0, 1, 2, \dots)$$

The Functions  $\sqrt{\frac{1}{2}\pi/z}K_{n+\frac{1}{2}}(z), n=0, 1, 2$

$$\begin{aligned} 10.2.17 \quad \sqrt{\frac{1}{2}\pi/z}K_{1/2}(z) &= (\frac{1}{2}\pi/z) e^{-z} \\ \sqrt{\frac{1}{2}\pi/z}K_{3/2}(z) &= (\frac{1}{2}\pi/z) e^{-z} (1+z^{-1}) \\ \sqrt{\frac{1}{2}\pi/z}K_{5/2}(z) &= (\frac{1}{2}\pi/z) e^{-z} (1+3z^{-1}+3z^{-2}) \end{aligned}$$

Elementary Properties

Recurrence Relations

$$f_n(z) : \sqrt{\frac{1}{2}\pi/z}I_{n+\frac{1}{2}}(z), (-1)^{n+1}\sqrt{\frac{1}{2}\pi/z}K_{n+\frac{1}{2}}(z) \quad (n=0, \pm 1, \pm 2, \dots)$$

$$10.2.18 \quad f_{n-1}(z) - f_{n+1}(z) = (2n+1)z^{-1}f_n(z)$$

$$10.2.19 \quad nf_{n-1}(z) + (n+1)f_{n+1}(z) = (2n+1)\frac{d}{dz}f_n(z)$$

$$10.2.20 \quad \frac{n+1}{z}f_n(z) + \frac{d}{dz}f_n(z) = f_{n-1}(z)$$

(See 10.2.22.)

$$10.2.21 \quad -\frac{n}{z}f_n(z) + \frac{d}{dz}f_n(z) = f_{n+1}(z)$$

(See 10.2.23.)

Differentiation Formulas

$$f_n(z) : \sqrt{\frac{1}{2}\pi/z}I_{n+\frac{1}{2}}(z), (-1)^{n+1}\sqrt{\frac{1}{2}\pi/z}K_{n+\frac{1}{2}}(z) \quad (n=0, \pm 1, \pm 2, \dots)$$

$$10.2.22 \quad \left(\frac{1}{z}\frac{d}{dz}\right)^m [z^{n+1}f_n(z)] = z^{n-m+1}f_{n-m}(z)$$

$$10.2.23 \quad \left(\frac{1}{z}\frac{d}{dz}\right)^m [z^{-n}f_n(z)] = z^{-n-m}f_{n+m}(z) \quad (m=1, 2, 3, \dots)$$

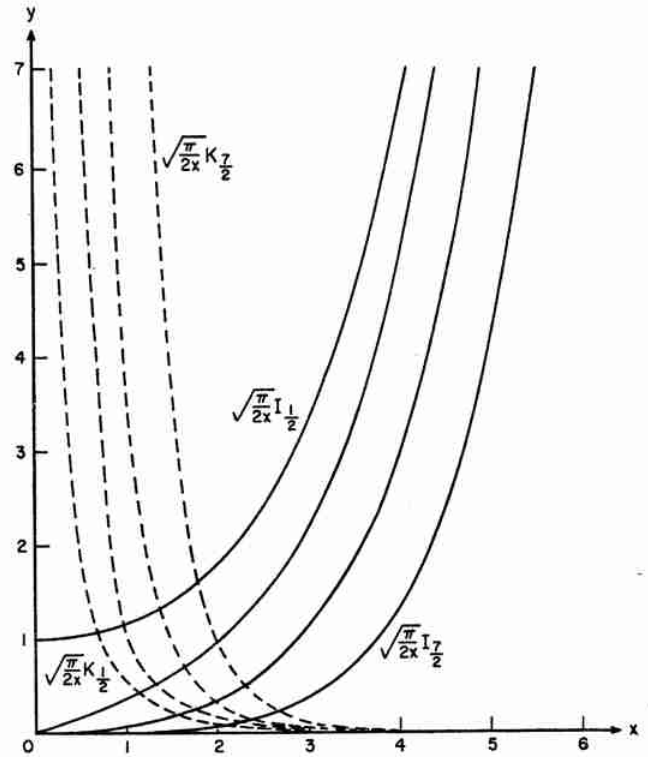

FIGURE 10.4.  $\sqrt{\frac{\pi}{2x}}I_{n+\frac{1}{2}}(x), \sqrt{\frac{\pi}{2x}}K_{n+\frac{1}{2}}(x), n=0(1)3.$

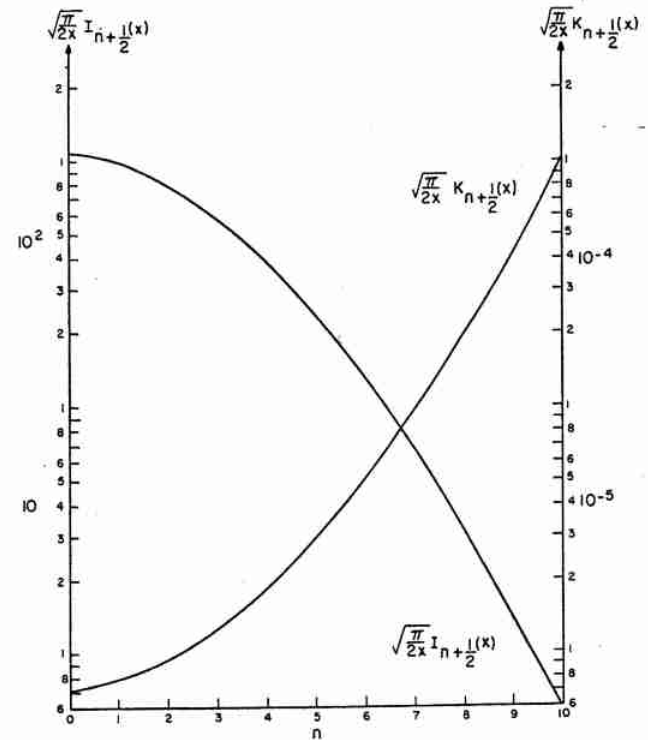

FIGURE 10.5.  $\sqrt{\frac{\pi}{2x}}I_{n+\frac{1}{2}}(x), \sqrt{\frac{\pi}{2x}}K_{n+\frac{1}{2}}(x), x=10.$

**Formulas of Rayleigh's Type**

10.2.24  $\sqrt{\frac{1}{2}\pi/z} I_{n+\frac{1}{2}}(z) = z^n \left(\frac{1}{z} \frac{d}{dz}\right)^n \frac{\sinh z}{z}$

10.2.25

$\sqrt{\frac{1}{2}\pi/z} I_{-n-\frac{1}{2}}(z) = z^n \left(\frac{1}{z} \frac{d}{dz}\right)^n \frac{\cosh z}{z}$   
 ( $n=0, 1, 2, \dots$ )

**Formulas for  $I_{n+\frac{1}{2}}^2(z) - I_{-n-\frac{1}{2}}^2(z)$**

10.2.26

$\left(\frac{1}{2}\pi/z\right)[I_{n+\frac{1}{2}}^2(z) - I_{-n-\frac{1}{2}}^2(z)]$   
 $= \frac{1}{z^2} \sum_0^n (-1)^{k+1} \frac{(2n-k)!(2n-2k)!}{k![(n-k)!]^2} (2z)^{2k-2n}$   
 ( $n=0, 1, 2, \dots$ )

10.2.27  $\left(\frac{1}{2}\pi/z\right)[I_{1/2}^2(z) - I_{-1/2}^2(z)] = -z^{-2}$

10.2.28  $\left(\frac{1}{2}\pi/z\right)[I_{3/2}^2(z) - I_{-3/2}^2(z)] = z^{-2} - z^{-4}$

10.2.29

$\left(\frac{1}{2}\pi/z\right)[I_{5/2}^2(z) - I_{-5/2}^2(z)] = -z^{-2} + 3z^{-4} - 9z^{-6}$

**Generating Functions**

10.2.30

$\frac{1}{z} \sinh \sqrt{z^2 - 2izt} = \sum_0^\infty \frac{(-it)^n}{n!} [\sqrt{\frac{1}{2}\pi/z} I_{-n+\frac{1}{2}}(z)]$   
 ( $2|t| < |z|$ )

10.2.31

$\frac{1}{z} \cosh \sqrt{z^2 + 2izt} = \sum_0^\infty \frac{(it)^n}{n!} [\sqrt{\frac{1}{2}\pi/z} I_{n-\frac{1}{2}}(z)]$

**Derivatives With Respect to Order**

10.2.32

$\left[\frac{\partial}{\partial \nu} I_\nu(x)\right]_{\nu=\frac{1}{2}} = -\frac{1}{2\pi x} [\text{Ei}(2x)e^{-x} - E_1(-2x)e^x]$

10.2.33

$\left[\frac{\partial}{\partial \nu} I_\nu(x)\right]_{\nu=-\frac{1}{2}} = \frac{1}{2\pi x} [\text{Ei}(2x)e^{-x} + E_1(-2x)e^x]$

10.2.34  $\left[\frac{\partial}{\partial \nu} K_\nu(x)\right]_{\nu=\pm\frac{1}{2}} = \mp \sqrt{\pi/2x} \text{Ei}(-2x)e^x$

For  $E_1(x)$  and  $\text{Ei}(x)$ , see 5.1.1, 5.1.2.

**Addition Theorems and Degenerate Forms**

$r, \rho, \theta, \lambda$  arbitrary complex;  $R = \sqrt{r^2 + \rho^2 - 2r\rho \cos \theta}$

10.2.35

$\frac{e^{-\lambda R}}{\lambda R} = \frac{2}{\pi} \sum_0^\infty (2n+1) [\sqrt{\frac{1}{2}\pi/\lambda r} I_{n+\frac{1}{2}}(\lambda r)]$   
 $[\sqrt{\frac{1}{2}\pi/\lambda \rho} K_{n+\frac{1}{2}}(\lambda \rho)] P_n(\cos \theta)$

10.2.36

$e^{z \cos \theta} = \sum_0^\infty (2n+1) [\sqrt{\frac{1}{2}\pi/z} I_{n+\frac{1}{2}}(z)] P_n(\cos \theta)$

10.2.37

$e^{-z \cos \theta} = \sum_0^\infty (-1)^n (2n+1) [\sqrt{\frac{1}{2}\pi/z} I_{n+\frac{1}{2}}(z)] P_n(\cos \theta)$

**Duplication Formula**

10.2.38

$K_{n+\frac{1}{2}}(2z) = n! \pi^{-\frac{1}{2}} z^{n+\frac{1}{2}} \sum_0^n \frac{(-1)^k (2n-2k+1)}{k!(2n-k+1)!} K_{n-k+\frac{1}{2}}^2(z)$

**10.3. Riccati-Bessel Functions**

**Differential Equation**

10.3.1

$z^2 w'' + [z^2 - n(n+1)]w = 0$   
 ( $n=0, \pm 1, \pm 2, \dots$ )

Pairs of linearly independent solutions are

$zj_n(z), zy_n(z)$   
 $zh_n^{(1)}(z), zh_n^{(2)}(z)$

All properties of these functions follow directly from those of the Spherical Bessel functions.

The Functions  $zj_n(z), zy_n(z), n=0, 1, 2$

10.3.2

$zj_0(z) = \sin z, \quad zj_1(z) = z^{-1} \sin z - \cos z$   
 $zy_0(z) = (3z^{-2} - 1) \sin z - 3z^{-1} \cos z$

10.3.3

$zy_0(z) = -\cos z, \quad zy_1(z) = -\sin z - z^{-1} \cos z$   
 $zy_2(z) = -3z^{-1} \sin z - (3z^{-2} - 1) \cos z$

**Wronskians**

10.3.4  $W\{zj_n(z), zy_n(z)\} = 1$

10.3.5  $W\{zh_n^{(1)}(z), zh_n^{(2)}(z)\} = -2i$   
 ( $n=0, 1, 2, \dots$ )

\*See page II.

10.4. Airy Functions

Definitions and Elementary Properties

Differential Equation

10.4.1  $w'' - zw = 0$

Pairs of linearly independent solutions are

- $Ai(z), Bi(z),$
- $Ai(z), Ai(ze^{2\pi i/3}),$
- $Ai(z), Ai(ze^{-2\pi i/3}).$

Ascending Series

10.4.2  $Ai(z) = c_1 f(z) - c_2 g(z)$

10.4.3  $Bi(z) = \sqrt{3}[c_1 f(z) + c_2 g(z)]$

$$f(z) = 1 + \frac{1}{3!} z^3 + \frac{1 \cdot 4}{6!} z^6 + \frac{1 \cdot 4 \cdot 7}{9!} z^9 + \dots$$

$$= \sum_0^{\infty} 3^k \left(\frac{1}{3}\right)_k \frac{z^{3k}}{(3k)!}$$

$$g(z) = z + \frac{2}{4!} z^4 + \frac{2 \cdot 5}{7!} z^7 + \frac{2 \cdot 5 \cdot 8}{10!} z^{10} + \dots$$

$$= \sum_0^{\infty} 3^k \left(\frac{2}{3}\right)_k \frac{z^{3k+1}}{(3k+1)!}$$

$$\left(\alpha + \frac{1}{3}\right)_0 = 1$$

$$3^k \left(\alpha + \frac{1}{3}\right)_k = (3\alpha + 1)(3\alpha + 4) \dots (3\alpha + 3k - 2)$$

( $\alpha$  arbitrary;  $k = 1, 2, 3, \dots$ )

(See 6.1.22.)

10.4.4

$$c_1 = Ai(0) = Bi(0) / \sqrt{3} = 3^{-2/3} / \Gamma(2/3)$$

$$= .35502 \ 80538 \ 87817$$

10.4.5

$$c_2 = -Ai'(0) = Bi'(0) / \sqrt{3} = 3^{-1/3} / \Gamma(1/3)$$

$$= .25881 \ 94037 \ 92807$$

Relations Between Solutions

10.4.6  $Bi(z) = e^{\pi i/6} Ai(ze^{2\pi i/3}) + e^{-\pi i/6} Ai(ze^{-2\pi i/3})$

10.4.7

$$Ai(z) + e^{2\pi i/3} Ai(ze^{2\pi i/3}) + e^{-2\pi i/3} Ai(ze^{-2\pi i/3}) = 0$$

10.4.8

$$Bi(z) + e^{2\pi i/3} Bi(ze^{2\pi i/3}) + e^{-2\pi i/3} Bi(ze^{-2\pi i/3}) = 0$$

10.4.9  $Ai(ze^{\pm 2\pi i/3}) = \frac{1}{2} e^{\pm \pi i/3} [Ai(z) \mp i Bi(z)]$

Wronskians

10.4.10  $W\{Ai(z), Bi(z)\} = \pi^{-1}$

10.4.11  $W\{Ai(z), Ai(ze^{2\pi i/3})\} = \frac{1}{2} \pi^{-1} e^{-\pi i/6}$

10.4.12  $W\{Ai(z), Ai(ze^{-2\pi i/3})\} = \frac{1}{2} \pi^{-1} e^{\pi i/6}$

10.4.13  $W\{Ai(ze^{2\pi i/3}), Ai(ze^{-2\pi i/3})\} = \frac{1}{2} i \pi^{-1}$

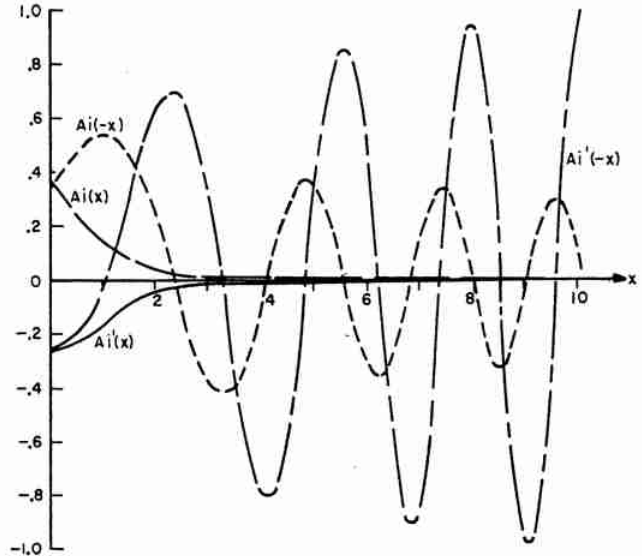

FIGURE 10.6.  $Ai(\pm x), Ai'(\pm x).$

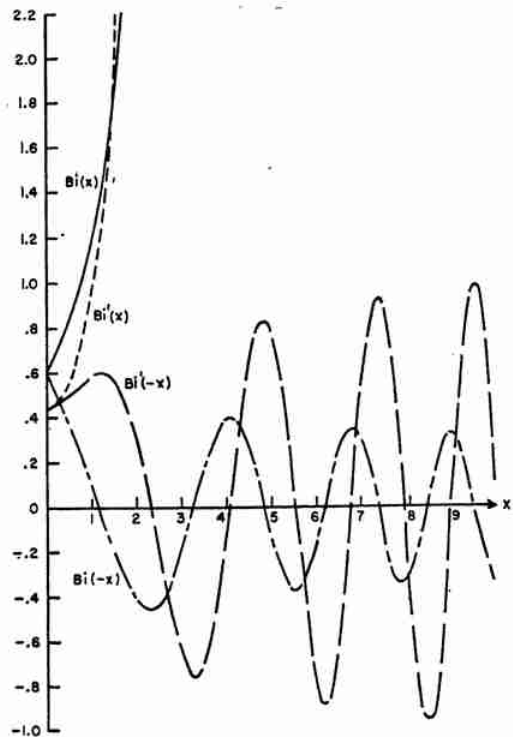

FIGURE 10.7.  $Bi(\pm x), Bi'(\pm x).$

Representations in Terms of Bessel Functions

$$\zeta = \frac{2}{3}z^{3/2}$$

10.4.14

$$\text{Ai}(z) = \frac{1}{3}\sqrt{z}[I_{-1/3}(\zeta) - I_{1/3}(\zeta)] = \pi^{-1}\sqrt{z/3}K_{1/3}(\zeta)$$

10.4.15

$$\begin{aligned} \text{Ai}(-z) &= \frac{1}{3}\sqrt{z}[J_{1/3}(\zeta) + J_{-1/3}(\zeta)] \\ &= \frac{1}{2}\sqrt{z/3}[e^{\pi i/6}H_{1/3}^{(1)}(\zeta) + e^{-\pi i/6}H_{1/3}^{(2)}(\zeta)] \end{aligned}$$

10.4.16

$$* -\text{Ai}'(z) = \frac{1}{3}z[I_{-2/3}(\zeta) - I_{2/3}(\zeta)] = \pi^{-1}(z/\sqrt{3})K_{2/3}(\zeta)$$

10.4.17

$$\begin{aligned} \text{Ai}'(-z) &= -\frac{1}{3}z[J_{-2/3}(\zeta) - J_{2/3}(\zeta)] \\ &= \frac{1}{2}(z/\sqrt{3})[e^{-\pi i/6}H_{2/3}^{(1)}(\zeta) + e^{\pi i/6}H_{2/3}^{(2)}(\zeta)] \end{aligned}$$

10.4.18  $\text{Bi}(z) = \sqrt{z/3}[I_{-1/3}(\zeta) + I_{1/3}(\zeta)]$

10.4.19

$$\begin{aligned} \text{Bi}(-z) &= \sqrt{z/3}[J_{-1/3}(\zeta) - J_{1/3}(\zeta)] \\ &= \frac{1}{2}i\sqrt{z/3}[e^{\pi i/6}H_{1/3}^{(1)}(\zeta) - e^{-\pi i/6}H_{1/3}^{(2)}(\zeta)] \end{aligned}$$

10.4.20  $\text{Bi}'(z) = (z/\sqrt{3})[I_{-2/3}(\zeta) + I_{2/3}(\zeta)]$

10.4.21

$$\begin{aligned} \text{Bi}'(-z) &= (z/\sqrt{3})[J_{-2/3}(\zeta) + J_{2/3}(\zeta)] \\ &= \frac{1}{2}i(z/\sqrt{3})[e^{-\pi i/6}H_{2/3}^{(1)}(\zeta) - e^{\pi i/6}H_{2/3}^{(2)}(\zeta)] \end{aligned}$$

Representations of Bessel Functions in Terms of Airy Functions

$$z = \left(\frac{3}{2}\zeta\right)^{2/3}$$

10.4.22  $J_{\pm 1/3}(\zeta) = \frac{1}{2}\sqrt{3/z}[\sqrt{3}\text{Ai}(-z) \mp \text{Bi}(-z)]$

\*10.4.23  $H_{\pm 1/3}^{(1)}(\zeta) = e^{\mp \pi i/6}\sqrt{3/z}[\text{Ai}(-z) - i\text{Bi}(-z)]$

10.4.24  $H_{\pm 1/3}^{(2)}(\zeta) = e^{\pm \pi i/6}\sqrt{3/z}[\text{Ai}(-z) + i\text{Bi}(-z)]$

10.4.25  $I_{\pm 1/3}(\zeta) = \frac{1}{2}\sqrt{3/z}[\mp \sqrt{3}\text{Ai}(z) + \text{Bi}(z)]$

10.4.26  $K_{\pm 1/3}(\zeta) = \pi\sqrt{3/z}\text{Ai}(z)$

10.4.27  $J_{\pm 2/3}(\zeta) = (\sqrt{3}/2z)[\pm \sqrt{3}\text{Ai}'(-z) + \text{Bi}'(-z)]$

10.4.28

$$\begin{aligned} H_{2/3}^{(1)}(\zeta) &= e^{-2\pi i/3}H_{-2/3}^{(1)}(\zeta) \\ &= e^{\pi i/6}(\sqrt{3}/z)[\text{Ai}'(-z) - i\text{Bi}'(-z)] \end{aligned}$$

10.4.29

$$\begin{aligned} H_{2/3}^{(2)}(\zeta) &= e^{2\pi i/3}H_{-2/3}^{(2)}(\zeta) \\ &= e^{-\pi i/6}(\sqrt{3}/z)[\text{Ai}'(-z) + i\text{Bi}'(-z)] \end{aligned}$$

\*See page II.

10.4.30  $I_{\pm 2/3}(\zeta) = (\sqrt{3}/2z)[\pm \sqrt{3}\text{Ai}'(z) + \text{Bi}'(z)]$

10.4.31  $K_{\pm 2/3}(\zeta) = -\pi(\sqrt{3}/z)\text{Ai}'(z)$

Integral Representations

10.4.32

$$(3a)^{-1/3}\pi \text{Ai}[\pm(3a)^{-1/3}x] = \int_0^\infty \cos(at^3 \pm xt)dt$$

10.4.33

$$\begin{aligned} (3a)^{-1/3}\pi \text{Bi}[\pm(3a)^{-1/3}x] \\ = \int_0^\infty [\exp(-at^3 \pm xt) + \sin(at^3 \pm xt)]dt \end{aligned}$$

The Integrals  $\int_0^z \text{Ai}(\pm t)dt, \int_0^z \text{Bi}(\pm t)dt$

$$\zeta = \frac{2}{3}z^{3/2}$$

10.4.34  $\int_0^z \text{Ai}(t)dt = \frac{1}{3}\int_0^\zeta [I_{-1/3}(t) - I_{1/3}(t)]dt$

10.4.35  $\int_0^z \text{Ai}(-t)dt = \frac{1}{3}\int_0^\zeta [J_{-1/3}(t) + J_{1/3}(t)]dt$

10.4.36  $\int_0^z \text{Bi}(t)dt = \frac{1}{\sqrt{3}}\int_0^\zeta [I_{-1/3}(t) + I_{1/3}(t)]dt$

10.4.37  $\int_0^z \text{Bi}(-t)dt = \frac{1}{\sqrt{3}}\int_0^\zeta [J_{-1/3}(t) - J_{1/3}(t)]dt$

Ascending Series for  $\int_0^z \text{Ai}(\pm t)dt, \int_0^z \text{Bi}(\pm t)dt$

10.4.38  $\int_0^z \text{Ai}(t)dt = c_1F(z) - c_2G(z)$

(See 10.4.2.)

10.4.39  $\int_0^z \text{Ai}(-t)dt = -c_1F(-z) + c_2G(-z)$

10.4.40  $\int_0^z \text{Bi}(t)dt = \sqrt{3}[c_1F(z) + c_2G(z)]$

(See 10.4.3.)

10.4.41

$$\int_0^z \text{Bi}(-t)dt = -\sqrt{3}[c_1F(-z) + c_2G(-z)]$$

$$F(z) = z + \frac{1}{4!}z^4 + \frac{1 \cdot 4}{7!}z^7 + \frac{1 \cdot 4 \cdot 7}{10!}z^{10} + \dots$$

$$= \sum_0^\infty 3^k \left(\frac{1}{3}\right)_k \frac{z^{3k+1}}{(3k+1)!}$$

$$G(z) = \frac{1}{2!}z^2 + \frac{2}{5!}z^5 + \frac{2 \cdot 5}{8!}z^8 + \frac{2 \cdot 5 \cdot 8}{11!}z^{11} + \dots$$

$$= \sum_0^\infty 3^k \left(\frac{2}{3}\right)_k \frac{z^{3k+2}}{(3k+2)!}$$

The constants  $c_1, c_2$  are given in 10.4.4, 10.4.5.

The Functions  $Gi(z)$ ,  $Hi(z)$ 

10.4.42

$$Gi(z) = \pi^{-1} \int_0^{\infty} \sin\left(\frac{1}{3}t^3 + zt\right) dt$$

$$= \frac{1}{3} Bi(z) + \int_0^z [Ai(z) Bi(t) - Ai(t) Bi(z)] dt$$

10.4.43

$$Gi'(z) = \frac{1}{3} Bi'(z) + \int_0^z [Ai'(z) Bi(t) - Ai(t) Bi'(z)] dt$$

10.4.44

$$Hi(z) = \pi^{-1} \int_0^{\infty} \exp\left(-\frac{1}{3}t^3 + zt\right) dt$$

$$= \frac{2}{3} Bi(z) + \int_0^z [Ai(t) Bi(z) - Ai(z) Bi(t)] dt$$

10.4.45

$$Hi'(z) = \frac{2}{3} Bi'(z) + \int_0^z [Ai(t) Bi'(z) - Ai'(z) Bi(t)] dt$$

$$10.4.46 \quad Gi(z) + Hi(z) = Bi(z)$$

Representations of  $\int_0^z Ai(\pm t) dt$ ,  $\int_0^z Bi(\pm t) dt$   
by  $Gi(\pm z)$ ,  $Hi(\pm z)$

10.4.47

$$\int_0^z Ai(t) dt = \frac{1}{3} + \pi [Ai'(z) Gi(z) - Ai(z) Gi'(z)]$$

10.4.48

$$= -\frac{2}{3} \pi [Ai'(z) Hi(z) - Ai(z) Hi'(z)]$$

10.4.49

$$\int_0^z Ai(-t) dt = -\frac{1}{3} - \pi [Ai'(-z) Gi(-z) - Ai(-z) Gi'(-z)]$$

10.4.50

$$= \frac{2}{3} + \pi [Ai'(-z) Hi(-z) - Ai(-z) Hi'(-z)]$$

10.4.51

$$\int_0^z Bi(t) dt = \pi [Bi'(z) Gi(z) - Bi(z) Gi'(z)]$$

$$10.4.52 \quad = -\pi [Bi'(z) Hi(z) - Bi(z) Hi'(z)]$$

10.4.53

$$\int_0^z Bi(-t) dt = -\pi [Bi'(-z) Gi(-z) - Bi(-z) Gi'(-z)]$$

$$10.4.54 \quad = \pi [Bi'(-z) Hi(-z) - Bi(-z) Hi'(-z)]$$

Differential Equations for  $Gi(z)$ ,  $Hi(z)$ 

$$10.4.55 \quad w'' - zw = -\pi^{-1}$$

$$w(0) = \frac{1}{3} Bi(0) = \frac{1}{\sqrt{3}} Ai(0) = .20497 55424 78$$

$$w'(0) = \frac{1}{3} Bi'(0) = -\frac{1}{\sqrt{3}} Ai'(0) = .14942 94524 49$$

$$w(z) = Gi(z)$$

$$10.4.56 \quad w'' - zw = \pi^{-1}$$

$$w(0) = \frac{2}{3} Bi(0) = \frac{2}{\sqrt{3}} Ai(0) = .40995 10849 56$$

$$w'(0) = \frac{2}{3} Bi'(0) = -\frac{2}{\sqrt{3}} Ai'(0) = .29885 89048 98$$

$$w(z) = Hi(z)$$

## Differential Equation for Products of Airy Functions

$$10.4.57 \quad w''' - 4zw' - 2w = 0$$

Linearly independent solutions are  $Ai^2(z)$ ,  $Ai(z) Bi(z)$ ,  $Bi^2(z)$ .

## Wronskian for Products of Airy Functions

$$10.4.58 \quad W\{Ai^2(z), Ai(z) Bi(z), Bi^2(z)\} = 2\pi^{-3}$$

Asymptotic Expansions for  $|z|$  Large

$$c_0 = 1, c_k = \frac{\Gamma(3k + \frac{1}{2})}{54^k k! \Gamma(k + \frac{1}{2})} = \frac{(2k+1)(2k+3)\dots(6k-1)}{216^k k!}$$

$$d_0 = 1, d_k = -\frac{6k+1}{6k-1} c_k \quad (k=1, 2, 3, \dots)$$

$$\zeta = \frac{2}{3} z^{3/2}$$

10.4.59

$$Ai(z) \sim \frac{1}{2} \pi^{-1/2} z^{-1/4} e^{-\zeta} \sum_0^{\infty} (-1)^k c_k \zeta^{-k} \quad (|\arg z| < \pi)$$

10.4.60

$$Ai(-z) \sim \pi^{-1/2} z^{-1/4} \left[ \sin\left(\zeta + \frac{\pi}{4}\right) \sum_0^{\infty} (-1)^k c_{2k} \zeta^{-2k} - \cos\left(\zeta + \frac{\pi}{4}\right) \sum_0^{\infty} (-1)^k c_{2k+1} \zeta^{-2k-1} \right]$$

$$(|\arg z| < \frac{3}{2}\pi)$$

10.4.61

$$Ai'(z) \sim -\frac{1}{2} \pi^{-1/2} z^{1/4} e^{-\zeta} \sum_0^{\infty} (-1)^k d_k \zeta^{-k}$$

$$(|\arg z| < \pi)$$

10.4.62

$$\begin{aligned} \text{Ai}'(-z) \sim & -\pi^{-1/2} z^{\dagger} \left[ \cos\left(\zeta + \frac{\pi}{4}\right) \sum_0^{\infty} (-1)^k d_{2k} \zeta^{-2k} \right. \\ & \left. + \sin\left(\zeta + \frac{\pi}{4}\right) \sum_0^{\infty} (-1)^k d_{2k+1} \zeta^{-2k-1} \right] \\ & \quad (|\arg z| < \frac{2}{3}\pi) \end{aligned}$$

10.4.63

$$\text{Bi}(z) \sim \pi^{-1/2} z^{-1/2} e^{\zeta} \sum_0^{\infty} c_k \zeta^{-k} \quad (|\arg z| < \frac{1}{3}\pi)$$

10.4.64

$$\begin{aligned} \text{Bi}(-z) \sim & \pi^{-1/2} z^{-1/2} \left[ \cos\left(\zeta + \frac{\pi}{4}\right) \sum_0^{\infty} (-1)^k c_{2k} \zeta^{-2k} \right. \\ & \left. + \sin\left(\zeta + \frac{\pi}{4}\right) \sum_0^{\infty} (-1)^k c_{2k+1} \zeta^{-2k-1} \right] \\ & \quad (|\arg z| < \frac{2}{3}\pi) \end{aligned}$$

10.4.65

$$\begin{aligned} \text{Bi}(ze^{\pm\pi i/3}) \\ \sim & \sqrt{2/\pi} e^{\pm\pi i/6} z^{-1/2} \left[ \sin\left(\zeta + \frac{\pi}{4} \mp \frac{i}{2} \ln 2\right) \sum_0^{\infty} (-1)^k c_{2k} \zeta^{-2k} \right. \\ & \left. - \cos\left(\zeta + \frac{\pi}{4} \mp \frac{i}{2} \ln 2\right) \sum_0^{\infty} (-1)^k c_{2k+1} \zeta^{-2k-1} \right] \\ & \quad (|\arg z| < \frac{2}{3}\pi) \end{aligned}$$

10.4.66

$$* \text{Bi}'(z) \sim \pi^{-1/2} z^{\dagger} e^{\zeta} \sum_0^{\infty} d_k \zeta^{-k} \quad (|\arg z| < \frac{1}{3}\pi)$$

10.4.67

$$\begin{aligned} \text{Bi}'(-z) \sim & \pi^{-1/2} z^{\dagger} \left[ \sin\left(\zeta + \frac{\pi}{4}\right) \sum_0^{\infty} (-1)^k d_{2k} \zeta^{-2k} \right. \\ & \left. - \cos\left(\zeta + \frac{\pi}{4}\right) \sum_0^{\infty} (-1)^k d_{2k+1} \zeta^{-2k-1} \right] \\ & \quad (|\arg z| < \frac{2}{3}\pi) \end{aligned}$$

10.4.68

$$\begin{aligned} \text{Bi}'(ze^{\pm\pi i/3}) \\ \sim & \sqrt{2/\pi} e^{\mp\pi i/6} z^{\dagger} \left[ \cos\left(\zeta + \frac{\pi}{4} \mp \frac{i}{2} \ln 2\right) \sum_0^{\infty} (-1)^k d_{2k} \zeta^{-2k} \right. \\ & \left. + \sin\left(\zeta + \frac{\pi}{4} \mp \frac{i}{2} \ln 2\right) \sum_0^{\infty} (-1)^k d_{2k+1} \zeta^{-2k-1} \right] \\ & \quad (|\arg z| < \frac{2}{3}\pi) \end{aligned}$$

Modulus and Phase

10.4.69

$$\begin{aligned} \text{Ai}(-x) = M(x) \cos \theta(x), \text{Bi}(-x) = M(x) \sin \theta(x) \\ M(x) = \sqrt{[\text{Ai}^2(-x) + \text{Bi}^2(-x)]}, \\ \theta(x) = \arctan [\text{Bi}(-x)/\text{Ai}(-x)] \end{aligned}$$

10.4.70

$$\begin{aligned} \text{Ai}'(-x) = N(x) \cos \phi(x), \text{Bi}'(-x) = N(x) \sin \phi(x) \\ N(x) = \sqrt{[\text{Ai}'^2(-x) + \text{Bi}'^2(-x)]}, \\ \phi(x) = \arctan [\text{Bi}'(-x)/\text{Ai}'(-x)] \end{aligned}$$

Differential Equations for Modulus and Phase

Primes denote differentiation with respect to  $x$

10.4.71  $M^2 \theta' = -\pi^{-1}, N^2 \phi' = -\pi^{-1} x$

10.4.72  $N^2 = M'^2 + M^2 \theta'^2 = M'^2 + \pi^{-2} M^{-2} \quad *$

10.4.73  $NN' = -xMM'$

10.4.74

$$\begin{aligned} \tan(\phi - \theta) = M\theta'/M' = -(\pi MM')^{-1}, \\ MN \sin(\phi - \theta) = \pi^{-1} \end{aligned}$$

10.4.75  $M'' + xM - \pi^{-2} M^{-3} = 0$

10.4.76  $(M^2)''' + 4x(M^2)' - 2M^2 = 0$

10.4.77  $\theta'^2 + \frac{1}{2}(\theta''/\theta') - \frac{3}{4}(\theta''/\theta')^2 = x$

Asymptotic Expansions of Modulus and Phase for Large  $x$

10.4.78  $M^2(x) \sim \frac{1}{\pi} x^{-1/2} \sum_0^{\infty} \frac{(-1)^k}{12^k k!} 2^{3k} \left(\frac{1}{2}\right)_{3k} (2x)^{-3k}$

10.4.79

$$\begin{aligned} \theta(x) \sim & \frac{1}{4}\pi - \frac{2}{3}x^{3/2} \left[ 1 - \frac{5}{4}(2x)^{-3} + \frac{1105}{96}(2x)^{-6} \right. \\ & \left. - \frac{82825}{128}(2x)^{-9} + \frac{1282031525}{14336}(2x)^{-12} - \dots \right] \end{aligned}$$

10.4.80

$$N^2(x) \sim \frac{1}{\pi} x^{\dagger} \sum_0^{\infty} \frac{(-1)^{k+1} 6k+1}{12^k k!} 2^{3k} \left(\frac{1}{2}\right)_{3k} (2x)^{-3k}$$

10.4.81

$$\begin{aligned} \phi(x) \sim & \frac{3}{4}\pi - \frac{2}{3}x^{3/2} \left[ 1 + \frac{7}{4}(2x)^{-3} - \frac{1463}{96}(2x)^{-6} \right. \\ & \left. + \frac{495271}{640}(2x)^{-9} - \frac{206530429}{2048}(2x)^{-12} + \dots \right] \end{aligned}$$

Asymptotic Forms of  $\int_0^x \text{Ai}(\pm t) dt, \int_0^x \text{Bi}(\pm t) dt$  for Large  $x$

10.4.82  $\int_0^x \text{Ai}(t) dt \sim \frac{1}{3} - \frac{1}{2}\pi^{-1/2} x^{-3/4} \exp\left(-\frac{2}{3}x^{3/2}\right)$

10.4.83

$$\int_0^x \text{Ai}(-t) dt \sim \frac{2}{3} - \pi^{-1/2} x^{-3/4} \cos\left(\frac{2}{3}x^{3/2} + \frac{\pi}{4}\right)$$

\*See page II.

10.4.84  $\int_0^x \text{Bi}(t) dt \sim \pi^{-1/2} x^{-3/4} \exp\left(\frac{2}{3} x^{3/2}\right)$

10.4.85  $\int_0^x \text{Bi}(-t) dt \sim \pi^{-1/2} x^{-3/4} \sin\left(\frac{2}{3} x^{3/2} + \frac{\pi}{4}\right)$

Asymptotic Forms of  $\text{Gi}(\pm x)$ ,  $\text{Gi}'(\pm x)$ ,  $\text{Hi}(\pm x)$ ,  $\text{Hi}'(\pm x)$  for Large  $x$

10.4.86  $\text{Gi}(x) \sim \pi^{-1} x^{-1}$

10.4.87  $\text{Gi}(-x) \sim \pi^{-1/2} x^{-1/4} \cos\left(\frac{2}{3} x^{3/2} + \frac{\pi}{4}\right)$

10.4.88  $\text{Gi}'(x) \sim \frac{7}{96} \pi^{-1} x^{-2}$

10.4.89  $\text{Gi}'(-x) \sim \pi^{-1/2} x^{1/4} \sin\left(\frac{2}{3} x^{3/2} + \frac{\pi}{4}\right)$

10.4.90  $\text{Hi}(x) \sim \pi^{-1/2} x^{-1/4} \exp\left(\frac{2}{3} x^{3/2}\right)$

10.4.91  $\text{Hi}(-x) \sim \pi^{-1} x^{-1}$

10.4.92  $\text{Hi}'(x) \sim \pi^{-1/2} x^{1/4} \exp\left(\frac{2}{3} x^{3/2}\right)$

10.4.93  $\text{Hi}'(-x) \sim -\frac{3}{2} \pi^{-1} x^{-2}$

Zeros and Their Asymptotic Expansions

$\text{Ai}(z)$ ,  $\text{Ai}'(z)$  have zeros on the negative real axis only.  $\text{Bi}(z)$ ,  $\text{Bi}'(z)$  have zeros on the negative real axis and in the sector  $\frac{1}{2}\pi < \arg z < \frac{3}{2}\pi$ .  $a_s, a'_s; b_s, b'_s$   $s$ -th (real) negative zero of  $\text{Ai}(z)$ ,  $\text{Ai}'(z)$ ;  $\text{Bi}(z)$ ,  $\text{Bi}'(z)$ , respectively.  $\beta_s, \beta'_s; \bar{\beta}_s, \bar{\beta}'_s$   $s$ -th complex zero of  $\text{Bi}(z)$ ,  $\text{Bi}'(z)$  in the sectors  $\frac{1}{2}\pi < \arg z < \frac{3}{2}\pi$ ,  $-\frac{1}{2}\pi < \arg z < -\frac{3}{2}\pi$ , respectively.

10.4.94  $a_s = -f[3\pi(4s-1)/8]$

10.4.95  $a'_s = -g[3\pi(4s-3)/8]$

10.4.96  $\text{Ai}'(a_s) = (-1)^{s-1} f_1[3\pi(4s-1)/8]$

10.4.97  $\text{Ai}(a'_s) = (-1)^{s-1} g_1[3\pi(4s-3)/8]$

10.4.98  $b_s = -f[3\pi(4s-3)/8]$

10.4.99  $b'_s = -g[3\pi(4s-1)/8]$

10.4.100  $\text{Bi}'(b_s) = (-1)^s f_1[3\pi(4s-3)/8]$

10.4.101  $\text{Bi}(b'_s) = (-1)^s g_1[3\pi(4s-1)/8]$

10.4.102  $\beta_s = e^{\pi i/3} f \left[ \frac{3\pi}{8} (4s-1) + \frac{3i}{4} \ln 2 \right]$

10.4.103  $\beta'_s = e^{\pi i/3} g \left[ \frac{3\pi}{8} (4s-3) + \frac{3i}{4} \ln 2 \right]$

10.4.104

$\text{Bi}'(\beta_s) = (-1)^s \sqrt{2} e^{-\pi i/6} f_1 \left[ \frac{3\pi}{8} (4s-1) + \frac{3i}{4} \ln 2 \right]$

10.4.105

$\text{Bi}(\beta'_s) = (-1)^{s-1} \sqrt{2} e^{\pi i/6} g_1 \left[ \frac{3\pi}{8} (4s-3) + \frac{3i}{4} \ln 2 \right]$

$|z|$  sufficiently large

$f(z) \sim z^{2/3} \left( 1 + \frac{5}{48} z^{-2} - \frac{5}{36} z^{-4} + \frac{77125}{82944} z^{-6} - \frac{108056875}{6967296} z^{-8} + \frac{162375596875}{334430208} z^{-10} - \dots \right)$

$g(z) \sim z^{2/3} \left( 1 - \frac{7}{48} z^{-2} + \frac{35}{288} z^{-4} - \frac{181223}{207360} z^{-6} + \frac{18683371}{1244160} z^{-8} - \frac{91145884361}{191102976} z^{-10} + \dots \right)$

$f_1(z) \sim \pi^{-1/2} z^{1/6} \left( 1 + \frac{5}{48} z^{-2} - \frac{1525}{4608} z^{-4} + \frac{2397875}{663552} z^{-6} - \dots \right)$

$g_1(z) \sim \pi^{-1/2} z^{-1/6} \left( 1 - \frac{7}{96} z^{-2} + \frac{1673}{6144} z^{-4} - \frac{84394709}{26542080} z^{-6} + \dots \right)$  \*

Formal and Asymptotic Solutions of Ordinary Differential Equations of Second Order With Turning Points

An equation

10.4.106  $W'' + a(z, \lambda)W' + b(z, \lambda)W = 0$

in which  $\lambda$  is a real or complex parameter and, for fixed  $\lambda$ ,  $a(z, \lambda)$  is analytic in  $z$  and  $b(z, \lambda)$  is continuous in  $z$  in some region of the  $z$ -plane, may be reduced by the transformation

10.4.107  $W(z) = w(z) \exp\left(-\frac{1}{2} \int^z a(t, \lambda) dt\right)$

to the equation

10.4.108

$w'' + \varphi(z, \lambda)w = 0$

$\varphi(z, \lambda) = b(z, \lambda) - \frac{1}{4} a^2(z, \lambda) - \frac{1}{2} \frac{d}{dz} a(z, \lambda).$

\*See page 11.



If  $\varphi(z, \lambda)$  can be written in the form

**10.4.109**  $\varphi(z, \lambda) = \lambda^2 p(z) + q(z, \lambda)$

where  $q(z, \lambda)$  is bounded in a region  $R$  of the  $z$ -plane, then the zeros of  $p(z)$  in  $R$  are said to be turning points of the equation **10.4.108**.

**The Special Case**  $w'' + [\lambda^2 z + q(z, \lambda)]w = 0$

Let  $\lambda = |\lambda|e^{i\omega}$  vary over a sectorial domain  $S$ :  $|\lambda| \geq \lambda_0 (> 0)$ ,  $\omega_1 \leq \omega \leq \omega_2$ , and suppose that  $q(z, \lambda)$  is continuous in  $z$  for  $|z| < r$  and  $\lambda$  in  $S$ , and  $q(z, \lambda)$

$\sim \sum_0^\infty q_n(z)\lambda^{-n}$  as  $\lambda \rightarrow \infty$  in  $S$ .

**Formal Series Solution**

**10.4.110**

$w(z) = u(z) \sum_0^\infty \varphi_n(z)\lambda^{-n} + \lambda^{-1}u'(z) \sum_0^\infty \psi_n(z)\lambda^{-n}$

$u'' + \lambda^2 zu = 0$

$\varphi_0(z) = c_0, \quad \psi_0(z) = z^{-1}c_1, \quad c_0, c_1$  constants

$\varphi_{n+1}(z) = -\frac{1}{2}\psi_n'(z) - \frac{1}{2} \int_0^z \sum_0^n q_{n-k}(t)\psi_k(t)dt$

$\psi_n(z) = \frac{1}{2}z^{-1} \int_0^z t^{-1} \left[ \varphi_n''(t) + \sum_0^n q_{n-k}(t)\varphi_k(t) \right] dt$   
( $n=0, 1, 2, \dots$ )

**Uniform Asymptotic Expansions of Solutions**

For  $z$  real, i.e. for the equation

**10.4.111**  $y'' + [\lambda^2 x + q(x, \lambda)]y = 0$

where  $x$  varies in a bounded interval  $a \leq x \leq b$  that includes the origin and where, for each fixed  $\lambda$  in  $S$ ,  $q(x, \lambda)$  is continuous in  $x$  for  $a \leq x \leq b$ , the following asymptotic representations hold.

(i) If  $\lambda$  is real and positive, there are solutions  $y_0(x), y_1(x)$  such that, uniformly in  $x$  on  $a \leq x \leq 0$ ,

**10.4.112**

$y_0(x) = \text{Ai}(-\lambda^{2/3}x)[1 + O(\lambda^{-1})] \quad (\lambda \rightarrow \infty)$

$y_1(x) = \text{Bi}(-\lambda^{2/3}x)[1 + O(\lambda^{-1})]$

and, uniformly in  $x$  on  $0 \leq x \leq b$

**10.4.113**

$y_0(x) = \text{Ai}(-\lambda^{2/3}x)[1 + O(\lambda^{-1})] + \text{Bi}(-\lambda^{2/3}x)O(\lambda^{-1}),$

$y_1(x) = \text{Bi}(-\lambda^{2/3}x)[1 + O(\lambda^{-1})] + \text{Ai}(-\lambda^{2/3}x)O(\lambda^{-1})$

( $\lambda \rightarrow \infty$ )

(ii) If  $\Re \lambda \geq 0, \Im \lambda \neq 0$ , there are solutions  $y_0(x), y_1(x)$  such that, uniformly in  $x$  on  $a \leq x \leq b$ ,

**10.4.114**

$y_0(x) = \text{Ai}(-\lambda^{2/3}x)[1 + O(\lambda^{-1})]$

$y_1(x) = \text{Bi}(-\lambda^{2/3}x)[1 + O(\lambda^{-1})] \quad (|\lambda| \rightarrow \infty)$

For further representations and details, we refer to [10.4].

When  $z$  is complex (bounded or unbounded), conditions under which the formal series **10.4.110** yields a uniform asymptotic expansion of a solution are given in [10.12] if  $q(z, \lambda)$  is independent of  $\lambda$  and  $|\lambda| \rightarrow \infty$  with fixed  $\omega$ , and in [10.14] if  $\lambda$  lies in any region of the complex plane. Further references are [10.2; 10.9; 10.10].

**The General Case**  $w'' + [\lambda^2 p(z) + q(z, \lambda)]w = 0$

Let  $\lambda = |\lambda|e^{i\omega}$  where  $|\lambda| \geq \lambda_0 (> 0)$  and  $-\pi \leq \omega \leq \pi$ ; suppose that  $p(z)$  is analytic in a region  $R$  and has a zero  $z = z_0$  in  $R$ , and that, for fixed  $\lambda$ ,  $q(z, \lambda)$  is analytic in  $z$  for  $z$  in  $R$ . The transformation  $\xi = \xi(z), v = [p(z)/\xi]^{1/4}w(z)$ , where  $\xi$  is defined as the (unique) solution of the equation

**10.4.115**  $\xi \left( \frac{d\xi}{dz} \right)^2 = p(z),$

yields the special case

**10.4.116**  $\frac{d^2v}{d\xi^2} + [\lambda^2 \xi + f(\xi, \lambda)]v = 0, \quad *$

$f(\xi, \lambda) = \left( \frac{d\xi}{dz} \right)^{-2} q(z, \lambda) - \left( \frac{d\xi}{dz} \right)^{-1} \frac{d^2}{d\xi^2} \left[ \left( \frac{d\xi}{dz} \right)^{\frac{1}{2}} \right].$

*Example:*

Consider the equation

**10.4.117**  $y'' + [\lambda^2 - (\lambda^2 - \frac{1}{4})x^{-2}]y = 0$

for which the points  $x=0, \infty$  are singular points and  $x=1$  is a turning point. It has the functions  $x^{\frac{1}{2}}J_\lambda(\lambda x), x^{\frac{1}{2}}Y_\lambda(\lambda x)$  as particular solutions (see **9.1.49**).

The equation **10.4.115** becomes

$\xi \left( \frac{d\xi}{dx} \right)^2 = \frac{x^2 - 1}{x^2}$

whence

$\frac{2}{3}(-\xi)^{3/2} = -\sqrt{1-x^2} + \ln x^{-1}(1 + \sqrt{1-x^2}) \quad (0 < x \leq 1)$

$\frac{2}{3}\xi^{3/2} = \sqrt{x^2-1} - \arccos x^{-1} \quad (1 \leq x < \infty).$

Thus

**10.4.118**  $v(\xi) = \left( \frac{x^2 - 1}{x^2 \xi} \right)^{1/4} y(x)$

\*See page II.

satisfies the equation

$$10.4.119 \quad \frac{d^2v}{d\xi^2} + \left[ \lambda^2 \xi - \frac{5}{16\xi^2} + \frac{\xi^2 x^2(x^2+4)}{4(x^2-1)^3} \right] v = 0$$

which is of the form 10.4.111 with  $x$  replaced by  $\xi$  and  $q(\xi, \lambda)$  independent of  $\lambda$ .

Suppose  $\Re \lambda \geq 0$ ,  $\Im \lambda \neq 0$ . By the first equation of 10.4.114 there is a solution  $v_0(\xi)$  of 10.4.119, i.e., a solution  $y_0(x)$  of 10.4.117 for which the representation

#### 10.4.120

$$v_0(\xi) = \left( \frac{x^2-1}{x^2\xi} \right)^{1/4} y_0(x) = \text{Ai}(-\lambda^{2/3}\xi)[1 + O(\lambda^{-1})]$$

holds uniformly in  $x$  on  $0 < x < \infty$  as  $|\lambda| \rightarrow \infty$ .

To identify  $y_0(x)$  in terms of  $x^{1/2}J_\lambda(\lambda x)$ ,  $x^{1/2}Y_\lambda(\lambda x)$ , restrict  $x$  to  $0 < x \leq b < 1$  so that by 10.4.118  $\xi$  is negative, and replace the Airy function by its asymptotic representation 10.4.59. This yields

#### 10.4.121

$$y_0(x) = \left( \frac{x^2-1}{x^2\xi} \right)^{-1/4} \frac{1}{2} \pi^{-1/2} \lambda^{-1/6} (-\xi)^{1/4} \exp\left(\frac{2}{3} \lambda (-\xi)^{3/2}\right) [1 + O(\lambda^{-1})]$$

$$= \frac{1}{2} \pi^{-1/2} \lambda^{-1/6} \left( \frac{1-x^2}{x^2} \right)^{-1/4} \exp\left(\frac{2}{3} \lambda (-\xi)^{3/2}\right) [1 + O(\lambda^{-1})]$$

Let now  $\lambda$  be fixed and  $x \rightarrow 0$  in 10.4.121. There results

$$10.4.122 \quad y_0(x) \sim \frac{1}{2} \pi^{-1/2} \lambda^{-1/6} x^{1/2} \left(\frac{2}{3} x\right)^\lambda e^\lambda.$$

On the other hand,  $y_0(x)$  is a solution of 10.4.117 and therefore it can be written in the form

$$10.4.123 \quad y_0(x) = x^{1/2} [c_1 J_\lambda(\lambda x) + c_2 Y_\lambda(\lambda x)]$$

where, from 9.1.7 for  $\lambda$  fixed and  $x \rightarrow 0$

$$J_\lambda(\lambda x) \sim \frac{(\frac{1}{2}\lambda x)^\lambda}{\Gamma(\lambda+1)},$$

$$Y_\lambda(\lambda x) \sim \frac{(\frac{1}{2}\lambda x)^\lambda}{\Gamma(\lambda+1)} \cot \lambda\pi - \frac{(\frac{1}{2}\lambda x)^{-\lambda}}{\Gamma(1-\lambda)} \csc \lambda\pi.$$

Thus, letting  $x \rightarrow 0$  in 10.4.123 and comparing the resulting relation with 10.4.122 one finds that  $c_2 = 0$  and

$$10.4.124 \quad y_0(x) = \frac{1}{2} \pi^{-1/2} \lambda^{-\lambda-1/6} e^\lambda \Gamma(\lambda+1) x^{1/2} J_\lambda(\lambda x).$$

It follows from 10.4.120 that uniformly in  $x$  on  $0 < x < \infty$

#### 10.4.125

$$J_\lambda(\lambda x) = \frac{2\pi^{1/2}}{\Gamma(\lambda+1)} \lambda^{\lambda+1/6} e^{-\lambda} \left( \frac{x^2-1}{\xi} \right)^{-1/4} \text{Ai}(-\lambda^{2/3}\xi) [1 + O(\lambda^{-1})] \quad (|\lambda| \rightarrow \infty)$$

## Numerical Methods

### 10.5. Use and Extension of the Tables

#### Spherical Bessel Functions

To compute  $j_n(x)$ ,  $y_n(x)$ ,  $n=0, 1, 2$ , for values of  $x$  outside the range of Table 10.1, use formulas 10.1.11, 10.1.12 and obtain values for the circular functions from Tables 4.6–4.8.

**Example 1.** Compute  $j_1(x)$  for  $x=11.425$ .

From 10.1.11,  $j_1(x) = \frac{\sin x}{x^2} - \frac{\cos x}{x}$ . Hence, using Tables 4.6 and 4.8,

$$j_1(11.425) = -\frac{.90920\ 500}{(11.425)^2} - \frac{.41634\ 873}{11.425}$$

$$= -.00696\ 54535 - .03644\ 1902$$

$$= -.04340\ 7356.$$

To compute  $j_n(x)$ ,  $11 \leq n \leq 20$ , for a value of  $x$  within the range of Table 10.3, obtain from Table 10.3, directly or possibly by linear interpolation,  $j_{21}(x)$ ,  $j_{20}(x)$  and use these as starting values in the recurrence relation 10.1.19 for decreasing  $n$ .

An alternative procedure which often yields better accuracy and which also applies to computations of  $j_n(x)$  when both  $n$  and  $x$  are outside the range of Table 10.1 is the following device essentially due to J. C. P. Miller [9.20].

At some value  $N$  larger than the desired value  $n$ , assume tentatively  $F_{N+1} = 0$ ,  $F_N = 1$  and use recurrence relation 10.1.19 for decreasing  $N$  to obtain the sequence  $F_{N-1}, \dots, F_0$ . If  $N$  was chosen large enough, each term of this sequence up to  $F_n$  is proportional, to a certain number of significant figures, to the corresponding term in the sequence  $j_{N-1}(x), \dots, j_0(x)$  of true values. The factor of proportionality,  $p$ , may be obtained by comparing, say,  $F_0$  with the true value  $j_0(x)$  computed separately. The terms in the sequence  $pF_0, \dots, pF_n$  are then accurate to the number of significant figures present in the tentative values. If the accuracy obtained is not sufficient, the process may be repeated by starting from a larger value  $N$ .

## References

## Texts

- [10.1] H. Bateman and R. C. Archibald, A guide to tables of Bessel functions, *Math. Tables Aids Comp.* **1**, 205-308 (1944), in particular, pp. 229-240.
- [10.2] T. M. Cherry, Uniform asymptotic formulae for functions with transition points, *Trans. Amer. Math. Soc.* **68**, 224-257 (1950).
- [10.3] A. Erdélyi et al., Higher transcendental functions, vol. 1, 2 (McGraw-Hill Book Co., Inc., New York, N.Y., 1953).
- [10.4] A. Erdélyi, Asymptotic expansions, California Institute of Technology, Dept. of Math., Technical Report No. 3, Pasadena, Calif. (1955).
- [10.5] A. Erdélyi, Asymptotic solutions of differential equations with transition points or singularities, *J. Mathematical Physics* **1**, 16-26 (1960).
- [10.6] H. Jeffreys, On certain approximate solutions of linear differential equations of the second order, *Proc. London Math. Soc.* **23**, 428-436 (1925).
- [10.7] H. Jeffreys, The effect on Love waves of heterogeneity in the lower layer, *Monthly Nat. Roy. Astr. Soc., Geophys. Suppl.* **2**, 101-111 (1928).
- [10.8] H. Jeffreys, On the use of asymptotic approximations of Green's type when the coefficient has zeros, *Proc. Cambridge Philos. Soc.* **52**, 61-66 (1956).
- [10.9] R. E. Langer, On the asymptotic solutions of differential equations with an application to the Bessel functions of large complex order, *Trans. Amer. Math. Soc.* **34**, 447-480 (1932).
- [10.10] R. E. Langer, The asymptotic solutions of ordinary linear differential equations of the second order, with special reference to a turning point, *Trans. Amer. Math. Soc.* **67**, 461-490 (1949).
- [10.11] W. Magnus and F. Oberhettinger, Formeln und Sätze für die speziellen Funktionen der mathematischen Physik, 2d ed. (Springer-Verlag, Berlin, Germany, 1948).
- [10.12] F. W. J. Olver, The asymptotic solution of linear differential equations of the second order for large values of a parameter, *Philos. Trans. Roy. Soc. London [A]* **247**, 307-327 (1954-55).
- [10.13] F. W. J. Olver, The asymptotic expansion of Bessel functions of large order, *Philos. Trans. Roy. Soc. London [A]* **247**, 328-368 (1954).
- [10.14] F. W. J. Olver, Uniform asymptotic expansions of solutions of linear second-order differential equations for large values of a parameter, *Philos. Trans. Roy. Soc. London [A]* **250**, 479-517 (1958).
- [10.15] W. R. Wasow, Turning point problems for systems of linear differential equations. Part I: The formal theory; Part II: The analytic theory. *Comm. Pure Appl. Math.* **14**, 657-673 (1961); **15**, 173-187 (1962).
- [10.16] G. N. Watson, A treatise on the theory of Bessel functions, 2d ed. (Cambridge Univ. Press, Cambridge, England, 1958).

## Tables

- [10.17] H. K. Crowder and G. C. Francis, Tables of spherical Bessel functions and ordinary Bessel functions of order half and odd integer of the first and second kind, Ballistic Research Laboratory Memorandum Report No. 1027, Aberdeen Proving Ground, Md. (1956).
- [10.18] A. T. Doodson, Bessel functions of half integral order [Riccati-Bessel functions], *British Assoc. Adv. Sci. Report*, 87-102 (1914).
- [10.19] A. T. Doodson, Riccati-Bessel functions, *British Assoc. Adv. Sci. Report*, 97-107 (1916).
- [10.20] A. T. Doodson, Riccati-Bessel functions, *British Assoc. Adv. Sci. Report*, 263-270 (1922).
- [10.21] Harvard University, Tables of the modified Hankel functions of order one-third and of their derivatives (Harvard Univ. Press, Cambridge, Mass., 1945).
- [10.22] E. Jahnke and F. Emde, Tables of functions, 4th ed. (Dover Publications, Inc., New York, N.Y., 1945).
- [10.23] C. W. Jones, A short table for the Bessel functions  $I_{n+\frac{1}{2}}(x)$ ,  $(2/\pi)K_{n+\frac{1}{2}}(x)$  (Cambridge Univ. Press, Cambridge, England, 1952).
- [10.24] J. C. P. Miller, The Airy integral, *British Assoc. Adv. Sci. Mathematical Tables, Part-vol. B* (Cambridge Univ. Press, Cambridge, England, 1946).
- [10.25] National Bureau of Standards, Tables of spherical Bessel functions, vols. I, II (Columbia Univ. Press, New York, N.Y., 1947).
- [10.26] National Bureau of Standards, Tables of Bessel functions of fractional order, vols. I, II (Columbia Univ. Press, New York, N.Y., 1948-49).
- [10.27] National Bureau of Standards, Integrals of Airy functions, Applied Math. Series 52 (U.S. Government Printing Office, Washington, D.C., 1958).
- [10.28] J. Proudman, A. T. Doodson and G. Kennedy, Numerical results of the theory of the diffraction of a plane electromagnetic wave by a conducting sphere, *Philos. Trans. Roy. Soc. London [A]* **217**, 279-314 (1916-18), in particular pp. 284-288.
- [10.29] M. Rothman, The problem of an infinite plate under an inclined loading, with tables of the integrals of  $Ai(\pm x)$ ,  $Bi(\pm x)$ , *Quart. J. Mech. Appl. Math.* **7**, 1-7 (1954).
- [10.30] M. Rothman, Tables of the integrals and differential coefficients of  $Gi(+x)$ ,  $Hi(-x)$ , *Quart. J. Mech. Appl. Math.* **7**, 379-384 (1954).
- [10.31] Royal Society Mathematical Tables, vol. 7, Bessel functions, Part III. Zeros and associated values (Cambridge Univ. Press, Cambridge, England, 1960).

[10.32] R. S. Scorer, Numerical evaluation of integrals of the form

$$I = \int_{x_1}^{x_2} f(x) e^{i\psi(x)} dx$$

and the tabulation of the function

$$\text{Gi}(z) = (1/\pi) \int_0^\infty \sin(uz + 1/3u^3) du,$$

Quart. J. Mech. Appl. Math. **3**, 107-112 (1950).

[10.33] A. D. Smirnov, Tables of Airy functions (and special confluent hypergeometric functions). Translated from the Russian by D. G. Fry (Pergamon Press, New York, N.Y., 1960).

[10.34] I. M. Vinogradov and N. G. Cetaev, Tables of Bessel functions of imaginary argument (Izdat. Akad. Nauk SSSR., Moscow, U.S.S.R., 1950).

[10.35] P. M. Woodward, A. M. Woodward, R. Hensman, H. H. Davies and N. Gamble, Four-figure tables of the Airy functions in the complex plane, Phil. Mag. (7) **37**, 236-261 (1946).

# 11. Integrals of Bessel Functions

YUDELL L. LUKE<sup>1</sup>

## Contents

|   | Page |
|---|------|
| <b>Mathematical Properties</b> . . . . .                    | 480  |
| 11.1. Simple Integrals of Bessel Functions . . . . .        | 480  |
| 11.2. Repeated Integrals of $J_n(z)$ and $K_0(z)$ . . . . . | 482  |
| 11.3. Reduction Formulas for Indefinite Integrals . . . . . | 483  |
| 11.4. Definite Integrals . . . . .                          | 485  |
| <b>Numerical Methods</b> . . . . .                          | 488  |
| 11.5. Use and Extension of the Tables . . . . .             | 488  |
| <b>References</b> . . . . .                                 | 490  |
| <b>Table 11.1</b> Integrals of Bessel Functions . . . . .   | 492  |

$$\left. \begin{array}{l} \int_0^x J_0(t)dt, \int_0^x Y_0(t)dt, 10D \\ e^{-x} \int_0^x I_0(t)dt, e^x \int_x^\infty K_0(t)dt, 7D \end{array} \right\} x=0(.1)10$$

|   |     |
|---|-----|
| <b>Table 11.2</b> Integrals of Bessel Functions . . . . . | 494 |
|---|-----|

$$\left. \begin{array}{l} \int_0^x \frac{[1-J_0(t)]dt}{t}, \int_x^\infty \frac{Y_0(t)dt}{t}, 8D \\ e^{-x} \int_0^x \frac{[I_0(t)-1]dt}{t}, 8D; xe^x \int_x^\infty \frac{K_0(t)dt}{t}, 6D \end{array} \right\} x=0(.1)5$$

The author acknowledges the assistance of Geraldine Coombs, Betty Kahn, Marilyn Kemp, Betty Ruhlman, and Anna Lee Samuels for checking formulas and developing numerical examples, only a portion of which could be accommodated here.

<sup>1</sup> Midwest Research Institute. (Prepared under contract with the National Bureau of Standards.)

# 11. Integrals of Bessel Functions

## Mathematical Properties

### 11.1. Simple Integrals of Bessel Functions

$$\int_0^z t^\nu J_\nu(t) dt$$

#### 11.1.1

$$\int_0^z t^\nu J_\nu(t) dt = \frac{z^\mu \Gamma\left(\frac{\nu+\mu+1}{2}\right)}{\Gamma\left(\frac{\nu-\mu+1}{2}\right)}$$

$$\times \sum_{k=0}^{\infty} \frac{(\nu+2k+1) \Gamma\left(\frac{\nu-\mu+1}{2}+k\right)}{\Gamma\left(\frac{\nu+\mu+3}{2}+k\right)} J_{\nu+2k+1}(z)$$

( $\Re(\mu+\nu+1) > 0$ )

#### 11.1.2

$$\int_0^z J_\nu(t) dt = 2 \sum_{k=0}^{\infty} J_{\nu+2k+1}(z) \quad (\Re \nu > -1)$$

#### 11.1.3

$$\int_0^z J_{2n}(t) dt = \int_0^z J_0(t) dt - 2 \sum_{k=0}^{n-1} J_{2k+1}(z)$$

#### 11.1.4

$$\int_0^z J_{2n+1}(t) dt = 1 - J_0(z) - 2 \sum_{k=1}^n J_{2k}(z)$$

#### Recurrence Relations

#### 11.1.5

$$\int_0^z J_{n+1}(t) dt = \int_0^z J_{n-1}(t) dt - 2J_n(z) \quad (n > 0)$$

#### 11.1.6

$$\int_0^z J_1(t) dt = 1 - J_0(z)$$

$$\int J_0(t) dt, \int Y_0(t) dt, \int I_0(t) dt, \int K_0(t) dt$$

#### 11.1.7

$$\int_0^z \mathcal{C}_0(t) dt = x \mathcal{C}_0(x) + \frac{1}{2} \pi x \{ \mathbf{H}_0(x) \mathcal{C}_1(x) - \mathbf{H}_1(x) \mathcal{C}_0(x) \}$$

$$\mathcal{C}_\nu(x) = A J_\nu(x) + B Y_\nu(x), \nu = 0, 1$$

$A$  and  $B$  are constants.

#### 11.1.8

$$\int_0^z Z_0(t) dt = x Z_0(x) + \frac{1}{2} \pi x \{ -\mathbf{L}_0(x) Z_1(x) + \mathbf{L}_1(x) Z_0(x) \}$$

$$Z_\nu(x) = A I_\nu(x) + B e^{i\pi\nu} K_\nu(x), \nu = 0, 1$$

$A$  and  $B$  are constants.

$\mathbf{H}_\nu(x)$  and  $\mathbf{L}_\nu(x)$  are Struve functions (see chapter 12).

#### 11.1.9

$$\int_0^z K_0(t) dt = -\left(\gamma + \ln \frac{x}{2}\right) x \sum_{k=0}^{\infty} \frac{(x/2)^{2k}}{(k!)^2 (2k+1)}$$

$$+ x \sum_{k=0}^{\infty} \frac{(x/2)^{2k}}{(k!)^2 (2k+1)^2}$$

$$+ x \sum_{k=1}^{\infty} \frac{(x/2)^{2k}}{(k!)^2 (2k+1)} \left(1 + \frac{1}{2} + \dots + \frac{1}{k}\right)$$

$$\gamma \text{ (Euler's constant)} = .57721\ 56649 \dots$$

In this and all other integrals of 11.1,  $x$  is real and positive although all the results remain valid for extended portions of the complex plane unless stated to the contrary.

#### 11.1.10

$$\int_0^{-iz} K_0(t) dt = \frac{\pi}{2} \int_0^z J_0(t) dt + i \frac{\pi}{2} \int_0^z Y_0(t) dt$$

#### Asymptotic Expansions

#### 11.1.11

$$\int_x^\infty [J_0(t) + iY_0(t)] dt \sim \left(\frac{2}{\pi x}\right)^{\frac{1}{2}} e^{i(x-\pi/4)}$$

$$\times \left[ \sum_{k=0}^{\infty} (-)^k a_{2k+1} x^{-2k-1} + i \sum_{k=0}^{\infty} (-)^k a_{2k} x^{-2k} \right]$$

#### 11.1.12

$$a_k = \frac{\Gamma(k+\frac{1}{2})}{\Gamma(\frac{1}{2})} \sum_{s=0}^k \frac{\Gamma(s+\frac{1}{2})}{2^s s! \Gamma(\frac{1}{2})}$$

#### 11.1.13

$$2(k+1)a_{k+1} = 3 \left(k + \frac{1}{2}\right) \left(k + \frac{5}{6}\right) a_k$$

$$- \left(k + \frac{1}{2}\right)^2 \left(k - \frac{1}{2}\right) a_{k-1}$$



11.1.14  $x^{\frac{1}{2}}e^{-x} \int_0^x I_0(t)dt \sim (2\pi)^{-\frac{1}{2}} \sum_{k=0}^{\infty} a_k x^{-k}$

where the  $a_k$  are defined as in 11.1.12.

11.1.15  $x^{\frac{1}{2}}e^x \int_x^{\infty} K_0(t)dt \sim \left(\frac{\pi}{2}\right)^{\frac{1}{2}} \sum_{k=0}^{\infty} (-)^k a_k x^{-k}$

where the  $a_k$  are defined as in 11.1.12.

Polynomial Approximations<sup>2</sup>

11.1.16  $8 \leq x \leq \infty$

$$\int_x^{\infty} [J_0(t) + iY_0(t)]dt = x^{-\frac{1}{2}}e^{i(x-\pi/4)} \left[ \sum_{k=0}^7 (-)^k a_k (x/8)^{-2k-1} + i \sum_{k=0}^7 (-)^k b_k (x/8)^{-2k} + \epsilon(x) \right]$$

$|\epsilon(x)| \leq 2 \times 10^{-9}$

| k | $a_k$        | $b_k$        |
|---|--------------|--------------|
| 0 | .06233 47304 | .79788 45600 |
| 1 | .00404 03539 | .01256 42405 |
| 2 | .00100 89872 | .00178 70944 |
| 3 | .00053 66189 | .00067 40148 |
| 4 | .00039 92825 | .00041 00676 |
| 5 | .00027 55037 | .00025 43955 |
| 6 | .00012 70039 | .00011 07299 |
| 7 | .00002 68482 | .00002 26238 |

11.1.17  $8 \leq x \leq \infty$

$$x^{\frac{1}{2}}e^{-x} \int_0^x I_0(t)dt = \sum_{k=0}^6 d_k (x/8)^{-k} + \epsilon(x)$$

$|\epsilon(x)| \leq 2 \times 10^{-8}$

| k | $d_k$      |
|---|------------|
| 0 | .39894 23  |
| 1 | .03117 34  |
| 2 | .00591 91  |
| 3 | .00559 56  |
| 4 | -.01148 58 |
| 5 | .01774 40  |
| 6 | -.00739 95 |

<sup>2</sup> Approximation 11.1.16 is from A. J. M. Hitchcock. Polynomial approximations to Bessel functions of order zero and one and to related functions, Math. Tables Aids Comp. 11, 86-88 (1957) (with permission).

11.1.18  $7 \leq x \leq \infty$

$$x^{\frac{1}{2}}e^x \int_x^{\infty} K_0(t)dt = \sum_{k=0}^6 (-)^k e_k (x/7)^{-k} + \epsilon(x)$$

$|\epsilon(x)| \leq 2 \times 10^{-7}$

| k | $e_k$       |
|---|-------------|
| 0 | 1.25331 414 |
| 1 | 0.11190 289 |
| 2 | .02576 646  |
| 3 | .00933 994  |
| 4 | .00417 454  |
| 5 | .00163 271  |
| 6 | .00033 934  |

$$\frac{\int J_0(t)dt}{t}, \frac{\int Y_0(t)dt}{t}, \frac{\int K_0(t)dt}{t}$$

11.1.19

$$\int_0^x \frac{1-J_0(t)}{t} dt$$

$$= 2x^{-1} \sum_{k=0}^{\infty} (2k+3)[\psi(k+2) - \psi(1)] J_{2k+3}(x)$$

$$= 1 - 2x^{-1} J_1(x)$$

$$+ 2x^{-1} \sum_{k=0}^{\infty} (2k+5)[\psi(k+3) - \psi(1) - 1] J_{2k+5}(x)$$

For  $\psi(z)$ , see 6.3.

11.1.20

$$\int_x^{\infty} \frac{J_0(t)dt}{t} + \gamma + \ln \frac{x}{2} = \int_0^x \frac{[1-J_0(t)]dt}{t} = - \sum_{k=1}^{\infty} \frac{(-)^k \left(\frac{x}{2}\right)^{2k}}{2k(k!)^2}$$

11.1.21

$$\int_x^{\infty} \frac{Y_0(t)dt}{t} = -\frac{1}{\pi} \left(\ln \frac{x}{2}\right)^2 - \frac{2\gamma}{\pi} \left(\ln \frac{x}{2}\right) + \frac{1}{\pi} \left(\frac{\pi^2}{6} - \gamma^2\right)$$

$$+ \frac{2}{\pi} \sum_{k=1}^{\infty} \frac{(-)^k \left(\frac{x}{2}\right)^{2k}}{2k(k!)^2} \left\{ \psi(k+1) + \frac{1}{2k} - \ln \frac{x}{2} \right\}$$

11.1.22

$$\int_x^{\infty} \frac{K_0(t)dt}{t} = \frac{1}{2} \left(\ln \frac{x}{2}\right)^2 + \gamma \ln \frac{x}{2} + \frac{\pi^2}{24} + \frac{\gamma^2}{2}$$

$$- \sum_{k=1}^{\infty} \frac{\left(\frac{x}{2}\right)^{2k}}{2k(k!)^2} \left\{ \psi(k+1) + \frac{1}{2k} - \ln \frac{x}{2} \right\}$$

11.1.23

$$\int_{-ix}^{-i\infty} \frac{K_0(t)dt}{t} = \frac{i\pi}{2} \int_x^{\infty} \frac{J_0(t)dt}{t} - \frac{\pi}{2} \int_x^{\infty} \frac{Y_0(t)dt}{t}$$



Asymptotic Expansions

$$11.1.24 \int_x^\infty \frac{\mathcal{C}_0(t)dt}{t} = \frac{2g_1(x)\mathcal{C}_0(x)}{x^2} - \frac{g_0(x)\mathcal{C}_1(x)}{x}$$

where

$$g_0(x) \sim \sum_{k=0}^\infty (-)^k \left(\frac{x}{2}\right)^{-2k} (k!)^2,$$

$$g_1(x) \sim \sum_{k=0}^\infty (-)^k \left(\frac{x}{2}\right)^{-2k} k!(k+1)!$$

$$11.1.25 \quad g_0(x) = 2x^2 \int_x^\infty \frac{g_1(t)dt}{t^3}$$

$$11.1.26 \quad x^{3/2}e^x \int_x^\infty \frac{K_0(t)dt}{t} \sim \left(\frac{\pi}{2}\right)^{1/2} \sum_{k=0}^\infty (-)^k c_k x^{-k}$$

where

$$11.1.27 \quad c_0 = 1, c_1 = \frac{13}{8}$$

$$2(k+1)c_{k+1} = \left[3(k+1)^2 + \frac{1}{4}\right]c_k - \left(k + \frac{1}{2}\right)^3 c_{k-1}$$

$$11.1.28 \quad x^{3/2}e^{-x} \int_0^x \frac{[I_0(t)-1]dt}{t} \sim (2\pi)^{-1/2} \sum_{k=0}^\infty c_k x^{-k}$$

where  $c_k$  is defined as in 11.1.27.

Polynomial Approximations

$$11.1.29 \quad 5 \leq x \leq \infty$$

$$\int_x^\infty \frac{\mathcal{C}_0(t)dt}{t} = \frac{2g_1(x)\mathcal{C}_0(x)}{x^2} - \frac{g_0(x)\mathcal{C}_1(x)}{x}$$

where

$$g_0(x) = \sum_{k=0}^9 (-)^k a_k (x/5)^{-2k} + \epsilon(x),$$

$$g_1(x) = \sum_{k=0}^9 (-)^k b_k (x/5)^{-2k} + \epsilon(x)$$

$$|\epsilon(x)| \leq 2 \times 10^{-7}$$

| k | $a_k$        | $b_k$        |
|---|--------------|--------------|
| 0 | 1.0          | 1.0          |
| 1 | 0.15999 2815 | 0.31998 5629 |
| 2 | .10161 9385  | .30485 8155  |
| 3 | .13081 1585  | .52324 6341  |
| 4 | .20740 4022  | 1.03702 0112 |
| 5 | .28330 0508  | 1.69980 3050 |
| 6 | .27902 9488  | 1.95320 6413 |
| 7 | .17891 5710  | 1.43132 5684 |
| 8 | .06622 8328  | 0.59605 4956 |
| 9 | .01070 2234  | .10702 2336  |

$$11.1.30 \quad 4 \leq x \leq \infty$$

$$x^{3/2}e^x \int_x^\infty \frac{K_0(t)dt}{t} = \sum_{k=0}^6 (-)^k d_k \left(\frac{x}{4}\right)^{-k} + \epsilon(x)$$

$$|\epsilon(x)| \leq 6 \times 10^{-6}$$

| k | $d_k$      |
|---|------------|
| 0 | 1.25331 41 |
| 1 | 0.50913 39 |
| 2 | .32191 84  |
| 3 | .26214 46  |
| 4 | .20601 26  |
| 5 | .11103 96  |
| 6 | .02724 00  |

$$11.1.31 \quad 5 \leq x \leq \infty$$

$$x^{3/2}e^{-x} \int_0^x \frac{[I_0(t)-1]dt}{t} = \sum_{k=0}^{10} f_k \left(\frac{x}{5}\right)^{-k} + \epsilon(x)$$

$$|\epsilon(x)| \leq 1.1 \times 10^{-5}$$

| k  | $f_k$        |
|----|--------------|
| 0  | 0.39893 14   |
| 1  | .13320 55    |
| 2  | -.04938 43   |
| 3  | 1.47800 44   |
| 4  | -8.65560 13  |
| 5  | 28.12214 78  |
| 6  | -48.05241 15 |
| 7  | 40.39473 40  |
| 8  | -11.90943 95 |
| 9  | -3.51950 09  |
| 10 | 2.19454 64   |

11.2. Repeated Integrals of  $J_n(z)$  and  $K_0(z)$

Repeated Integrals of  $J_n(z)$

Let

$$11.2.1$$

$$f_{0,n}(z) = J_n(z),$$

$$f_{1,n}(z) = \int_0^z J_n(t)dt, \dots, f_{r,n}(z) = \int_0^z f_{r-1,n}(t)dt$$

$$11.2.2$$

$$f_{-r,n}(z) = \frac{d^r}{dz^r} J_n(z)$$

Then

$$11.2.3$$

$$f_{r,n}(z) = \frac{1}{\Gamma(r)} \int_0^z (z-t)^{r-1} J_n(t)dt \quad (\Re r > 0)$$

$$11.2.4 \quad f_{r,n}(z) = \frac{2^r}{\Gamma(r)} \sum_{k=0}^\infty \frac{\Gamma(k+r)}{k!} J_{n+r+2k}(z)$$

**Recurrence Relations**

11.2.5

$$r(r-1)f_{r+1, n}(z) = 2(r-1)zf_{r, n}(z) - [(1-r)^2 - n^2 + z^2]f_{r-1, n}(z) + (2r-3)zf_{r-2, n}(z) - z^2f_{r-3, n}(z)$$

11.2.6

$$rf_{r+1, 0}(z) = zf_{r, 0}(z) - (r-1)f_{r-1, 0}(z) + zf_{r-2, 0}(z)$$

11.2.7  $f_{r+1, n+1}(z) = f_{r+1, n-1}(z) - 2f_{r, n}(z)$

**Repeated Integrals of  $K_0(z)$**

Let

11.2.8

$$Ki_0(z) = K_0(z),$$

$$Ki_1(z) = \int_z^\infty K_0(t)dt, \dots, Ki_r(z) = \int_z^\infty Ki_{r-1}(t)dt$$

11.2.9  $Ki_{-r}(z) = (-1)^r \frac{d^r}{dz^r} K_0(z)$

Then

11.2.10

$$Ki_r(z) = \int_0^\infty \frac{e^{-z \cosh t}}{\cosh^r t} dt$$

$(\Re z \geq 0, \Re r > 0, \Re z > 0, r=0)$

11.2.11

$$Ki_r(z) = \frac{1}{\Gamma(r)} \int_z^\infty (t-z)^{r-1} K_0(t) dt$$

$(\Re z \geq 0, \Re r > 0)$

11.2.12  $Ki_{2r}(0) = \frac{\Gamma(r)\Gamma(\frac{3}{2})}{\Gamma(r+\frac{1}{2})}$   $(\Re r > 0)$

11.2.13  $Ki_{2r+1}(0) = \frac{\pi}{2} \frac{\Gamma(r+\frac{1}{2})}{\Gamma(\frac{1}{2})\Gamma(r+1)}$   $(\Re r > -\frac{1}{2})$

11.2.14

$$rKi_{r+1}(z) = -zKi_r(z) + (r-1)Ki_{r-1}(z) + zKi_{r-2}(z)$$

**11.3. Reduction Formulas for Indefinite Integrals**

Let

11.3.1  $g_{\mu, \nu}(z) = \int^z e^{-\nu t} t^\mu Z_\nu(t) dt$

where  $Z_\nu(z)$  represents any of the Bessel functions of the first three kinds or the modified Bessel functions. The parameters  $a$  and  $b$  appearing in the reduction formulae are associated with the particular type of Bessel function as delineated in the following table.

| 11.3.2 | $Z_\nu(z)$   | $a$ | $b$ |
|--------|--|-----|-----|
|        | $J_\nu(z), Y_\nu(z), H_\nu^{(1)}(z), H_\nu^{(2)}(z)$ | 1   | 1   |
|        | $I_\nu(z)$   | -1  | 1   |
|        | $K_\nu(z)$   | 1   | -1  |

11.3.3

$$pg_{\mu, \nu}(z) = -e^{-\nu z} z^\mu Z_\nu(z) + (\mu + \nu)g_{\mu-1, \nu}(z) - ag_{\mu, \nu+1}(z)$$

11.3.4

$$pg_{\mu, \nu+1}(z) = -e^{-\nu z} z^\mu Z_{\nu+1}(z) + (\mu - \nu - 1)g_{\mu-1, \nu+1}(z) + bg_{\mu, \nu}(z)$$

11.3.5

$$(p^2 + ab)g_{\mu, \nu}(z) = ae^{-\nu z} z^\mu Z_{\nu+1}(z) + (\mu - \nu - 1)e^{-\nu z} z^{\mu-1} Z_\nu(z) - pe^{-\nu z} z^\mu Z_\nu(z) + p(2\mu - 1)g_{\mu-1, \nu}(z) + [\nu^2 - (\mu - 1)^2]g_{\mu-2, \nu}(z)$$

11.3.6

$$a(\nu - \mu)g_{\mu, \nu+1}(z) = -2\nu e^{-\nu z} z^\mu Z_\nu(z) - 2\nu pg_{\mu, \nu}(z) + b(\mu + \nu)g_{\mu, \nu-1}(z)$$

Case 1:  $p^2 + ab = 0, \nu = \pm(\mu - 1)$

11.3.7  $g_{\nu, \nu}(z) = \frac{e^{-\nu z} z^{\nu+1}}{2\nu + 1} \left\{ Z_\nu(z) - \frac{a}{p} Z_{\nu+1}(z) \right\}$

11.3.8  $g_{-\nu, \nu}(z) = -\frac{e^{-\nu z} z^{-\nu+1}}{2\nu - 1} \left\{ Z_\nu(z) + \frac{b}{p} Z_{\nu-1}(z) \right\}$

11.3.9

$$\int_0^z e^{it} t^\nu J_\nu(t) dt = \frac{e^{iz} z^{\nu+1}}{2\nu + 1} [J_\nu(z) - iJ_{\nu+1}(z)]$$

$(\Re \nu > -\frac{1}{2})$

11.3.10

$$\int_0^z e^{it} t^{-\nu} J_\nu(t) dt = -\frac{e^{iz} z^{-\nu+1}}{2\nu - 1} [J_\nu(z) + iJ_{\nu-1}(z)] + \frac{i}{2^{\nu-1}(2\nu-1)\Gamma(\nu)}$$

$(\nu \neq \frac{1}{2})$

11.3.11

$$\int_0^z e^{it} t^\nu Y_\nu(t) dt = \frac{e^{iz} z^{\nu+1}}{2\nu + 1} [Y_\nu(z) - iY_{\nu+1}(z)] - \frac{i2^{\nu+1}\Gamma(\nu+1)}{\pi(2\nu+1)}$$

$(\Re \nu > -\frac{1}{2})$

11.3.12

$$\int_0^z e^{\pm it} t^\nu I_\nu(t) dt = \frac{e^{\pm iz} z^{\nu+1}}{2\nu + 1} [I_\nu(z) \mp I_{\nu+1}(z)]$$

$(\Re \nu > -\frac{1}{2})$

## 11.3.13

$$\int_0^z e^{-t} I_n(t) dt = z e^{-z} [I_0(z) + I_1(z)] \\ + n [e^{-z} I_0(z) - 1] + 2e^{-z} \sum_{k=1}^{n-1} (n-k) I_k(z)$$

## 11.3.14

$$\int_0^z e^{\pm t} t^{-\nu} I_\nu(t) dt = -\frac{e^{\pm z} z^{-\nu+1}}{2\nu-1} [I_\nu(z) \mp I_{\nu-1}(z)] \\ \mp \frac{1}{2^{\nu-1} (2\nu-1) \Gamma(\nu)} \quad (\nu \neq \frac{1}{2})$$

## 11.3.15

$$\int_0^z e^{\pm t} t^\nu K_\nu(t) dt = \frac{e^{\pm z} z^{\nu+1}}{2\nu+1} [K_\nu(z) \pm K_{\nu+1}(z)] \\ \mp \frac{2^\nu \Gamma(\nu+1)}{2\nu+1} \quad (\Re \nu > -\frac{1}{2})$$

King's integral (see [11.5])

$$11.3.16 \quad \int_0^z e^t K_0(t) dt = z e^z [K_0(z) + K_1(z)] - 1$$

## 11.3.17

$$\int_z^\infty e^t t^{-\nu} K_\nu(t) dt \\ = \frac{e^z z^{-\nu+1}}{2\nu-1} [K_\nu(z) + K_{\nu-1}(z)] \quad (\Re \nu > \frac{1}{2})$$

Case 2:  $p=0, \mu=\pm\nu$

$$11.3.18 \quad b g_{\nu, \nu-1}(z) = z^\nu Z_\nu(z)$$

$$11.3.19 \quad a g_{-\nu, \nu+1}(z) = -z^{-\nu} Z_\nu(z)$$

$$11.3.20 \quad \int_0^z t^\nu J_{\nu-1}(t) dt = z^\nu J_\nu(z) \quad (\Re \nu > 0)$$

$$11.3.21 \quad \int_0^z t^{-\nu} J_{\nu+1}(t) dt = \frac{1}{2^\nu \Gamma(\nu+1)} - z^{-\nu} J_\nu(z)$$

## 11.3.22

$$2n \int_0^z \frac{J_{2n}(t) dt}{t} = 1 - \frac{2}{z} \sum_{k=1}^n (2k-1) J_{2k-1}(z) \\ = \frac{2}{z} \sum_{k=n+1}^\infty (2k-1) J_{2k-1}(z) \quad (n > 0)$$

## 11.3.23

$$(2n+1) \int_0^z \frac{J_{2n+1}(t) dt}{t} = \int_0^z J_0(t) dt \\ - J_1(z) - \frac{4}{z} \sum_{k=1}^n k J_{2k}(z)$$

## 11.3.24

$$\int_0^z t^\nu Y_{\nu-1}(t) dt = z^\nu Y_\nu(z) + \frac{2^\nu \Gamma(\nu)}{\pi} \quad (\Re \nu > 0)$$

$$11.3.25 \quad \int_0^z t^\nu I_{\nu-1}(t) dt = z^\nu I_\nu(z) \quad (\Re \nu > 0)$$

$$11.3.26 \quad \int_0^z t^{-\nu} I_{\nu+1}(t) dt = z^{-\nu} I_\nu(z) - \frac{1}{2^\nu \Gamma(\nu+1)}$$

## 11.3.27

$$\int_0^z t^\nu K_{\nu-1}(t) dt = -z^\nu K_\nu(z) + 2^{\nu-1} \Gamma(\nu) \quad (\Re \nu > 0)$$

$$11.3.28 \quad \int_z^\infty t^{-\nu} K_{\nu+1}(t) dt = z^{-\nu} K_\nu(z)$$

## Indefinite Integrals of Products of Bessel Functions

Let  $\mathcal{C}_\mu(z)$  and  $\mathcal{D}_\nu(z)$  denote any two cylinder functions of orders  $\mu$  and  $\nu$  respectively.

## 11.3.29

$$\int^z \left\{ (k^2 - l^2) t - \frac{(\mu^2 - \nu^2)}{t} \right\} \mathcal{C}_\mu(kt) \mathcal{D}_\nu(lt) dt \\ = z \{ k \mathcal{C}_{\mu+1}(kz) \mathcal{D}_\nu(lz) - l \mathcal{C}_\mu(kz) \mathcal{D}_{\nu+1}(lz) \} \\ - (\mu - \nu) \mathcal{C}_\mu(kz) \mathcal{D}_\nu(lz) \quad *$$

## 11.3.30

$$\int^z t^{-\mu-\nu-1} \mathcal{C}_{\mu+1}(t) \mathcal{D}_{\nu+1}(t) dt \\ = -\frac{z^{-\mu-\nu}}{2(\mu+\nu+1)} \{ \mathcal{C}_\mu(z) \mathcal{D}_\nu(z) + \mathcal{C}_{\mu+1}(z) \mathcal{D}_{\nu+1}(z) \}$$

## 11.3.31

$$\int^z t^{\mu+\nu+1} \mathcal{C}_\mu(t) \mathcal{D}_\nu(t) dt \\ = \frac{z^{\mu+\nu+2}}{2(\mu+\nu+1)} \{ \mathcal{C}_\mu(z) \mathcal{D}_\nu(z) + \mathcal{C}_{\mu+1}(z) \mathcal{D}_{\nu+1}(z) \}$$

## 11.3.32

$$\int_0^z t J_{\nu-1}^2(t) dt = 2 \sum_{k=0}^\infty (\nu+2k) J_{\nu+2k}^2(z) \quad (\Re \nu > 0)$$

## 11.3.33

$$\int_0^z t [J_{\nu-1}^2(t) - J_{\nu+1}^2(t)] dt = 2\nu J_\nu^2(z) \quad (\Re \nu > 0)$$

$$11.3.34 \quad \int_0^z t J_0^2(t) dt = \frac{z^2}{2} [J_0^2(z) + J_1^2(z)]$$

## 11.3.35

$$\int_0^z J_n(t) J_{n+1}(t) dt = \frac{1}{2} [1 - J_0^2(z)] - \sum_{k=1}^n J_k^2(z) \\ = \sum_{k=n+1}^\infty J_k^2(z)$$

\*See page II.

11.3.36

$$\begin{aligned} & (\mu + \nu) \int^z t^{-1} \mathcal{C}_\mu(t) \mathcal{D}_\nu(t) dt \\ & - (\mu + \nu + 2n) \int^z t^{-1} \mathcal{C}_{\mu+n}(t) \mathcal{D}_{\nu+n}(t) dt \\ & = \mathcal{C}_\mu(z) \mathcal{D}_\nu(z) + \mathcal{C}_{\mu+n}(z) \mathcal{D}_{\nu+n}(z) + 2 \sum_{k=1}^{n-1} \mathcal{C}_{\mu+k}(z) \mathcal{D}_{\nu+k}(z) \end{aligned}$$

Convolution Type Integrals

11.3.37

$$\int_0^z J_\mu(t) J_\nu(z-t) dt = 2 \sum_{k=0}^{\infty} (-1)^k J_{\mu+\nu+2k+1}(z) \quad (\Re \mu > -1, \Re \nu > -1)$$

11.3.38

$$\int_0^z J_\nu(t) J_{1-\nu}(z-t) dt = J_0(z) - \cos z \quad (-1 < \Re \nu < 2)$$

11.3.39

$$\int_0^z J_\nu(t) J_{-\nu}(z-t) dt = \sin z \quad (|\Re \nu| < 1)$$

11.3.40

$$\int_0^z t^{-1} J_\mu(t) J_\nu(z-t) dt = \frac{J_{\mu+\nu}(z)}{\mu} \quad (\Re \mu > 0, \Re \nu > -1)$$

11.3.41

$$\int_0^z \frac{J_\mu(t) J_\nu(z-t) dt}{t(z-t)} = \frac{(\mu + \nu) J_{\mu+\nu}(z)}{\mu \nu z} \quad (\Re \mu > 0, \Re \nu > 0)$$

11.4. Definite Integrals

Orthogonality Properties of Bessel Functions

Let  $\mathcal{C}_\nu(z)$  be a cylinder function of order  $\nu$ . In particular, let

11.4.1  $\mathcal{C}_\nu(z) = AJ_\nu(z) + BY_\nu(z)$

where  $A$  and  $B$  are real constants. Then

11.4.2

$$\begin{aligned} & \int_a^b t \mathcal{C}_\nu(\lambda_m t) \mathcal{C}_\nu(\lambda_n t) dt = 0 \quad (m \neq n) \\ & = \left[ \frac{1}{2} t^2 \left\{ \left( 1 - \frac{\nu^2}{\lambda_n^2 t^2} \right) \mathcal{C}_\nu'(\lambda_n t) + \mathcal{C}_\nu'^2(\lambda_n t) \right\} \right]_a^b \\ & \quad (m=n) (0 < a < b) \end{aligned}$$

provided the following two conditions hold:

1.  $\lambda_n$  is a real zero of

11.4.3  $h_1 \lambda \mathcal{C}_{\nu+1}(\lambda b) - h_2 \mathcal{C}_\nu(\lambda b) = 0$

2. There must exist numbers  $k_1$  and  $k_2$  (both not zero) so that for all  $n$

11.4.4  $k_1 \lambda_n \mathcal{C}_{\nu+1}(\lambda_n a) - k_2 \mathcal{C}_\nu(\lambda_n a) = 0$

In connection with these formulae, see 11.3.29. If  $a=0$ , the above is, valid provided  $B=0$ . This case is covered by the following result.

11.4.5

$$\begin{aligned} & \int_0^1 t J_\nu(\alpha_m t) J_\nu(\alpha_n t) dt = 0 \quad (m \neq n, \nu > -1) \\ & = \frac{1}{2} [J_\nu'(\alpha_n)]^2 \quad (m=n, b=0, \nu > -1) \\ & = \frac{1}{2\alpha_n^2} \left[ \frac{a^2}{b^2} + \alpha_n^2 - \nu^2 \right] [J_\nu(\alpha_n)]^2 \quad (m=n, b \neq 0, \nu \geq -1) \end{aligned}$$

$\alpha_1, \alpha_2, \dots$  are the positive zeros of  $aJ_\nu(x) + bxJ_\nu'(x) = 0$ , where  $a$  and  $b$  are real constants.

11.4.6

$$\begin{aligned} & \int_0^\infty t^{-1} J_{\nu+2n+1}(t) J_{\nu+2m+1}(t) dt = 0 \quad (m \neq n) \\ & = \frac{1}{2(2n+\nu+1)} \quad (m=n) (\nu+n+m > -1) \end{aligned}$$

Definite Integrals Over a Finite Range

11.4.7  $\int_0^{\frac{\pi}{2}} J_{2n}(2z \sin t) dt = \frac{\pi}{2} J_n^2(z)$

11.4.8  $\int_0^\pi J_0(2z \sin t) \cos 2nt dt = \pi J_n^2(z)$

11.4.9  $\int_0^{\frac{\pi}{2}} Y_0(2z \sin t) \cos 2nt dt = \frac{\pi}{2} J_n(z) Y_n(z)$

11.4.10

$$\begin{aligned} & \int_0^{\frac{\pi}{2}} J_\nu(z \sin t) \sin^{\mu+1} t \cos^{2\nu+1} t dt \\ & = \frac{2^\nu \Gamma(\nu+1)}{z^{\nu+1}} J_{\mu+\nu+1}(z) \quad (\Re \mu > -1, \Re \nu > -1) \end{aligned}$$

11.4.11

$$\begin{aligned} & \int_0^{\frac{\pi}{2}} J_\nu(z \sin^2 t) J_\nu(z \cos^2 t) \csc 2t dt \\ & = \frac{(\mu + \nu)}{4\mu\nu} J_{\mu+\nu}(z) \quad (\Re \mu > 0, \Re \nu > 0) \end{aligned}$$

## Infinite Integrals

Integrals of the Form  $\int_0^\infty e^{-\nu t} t^\mu Z_\nu(t) dt$ 

11.4.12

$$\int_0^\infty e^{it} t^{\mu-1} J_\nu(t) dt = \frac{e^{\frac{1}{2}i\pi(\mu+\nu)} \Gamma(\mu+\nu) \Gamma(\frac{1}{2}-\mu)}{\Gamma(\frac{1}{2}) 2^\mu \Gamma(\nu-\mu+1)}$$

$$\left( \Re \mu < \frac{1}{2}, \Re(\mu+\nu) > 0 \right)$$

11.4.13

$$\int_0^\infty e^{-t} t^{\mu-1} I_\nu(t) dt = \frac{\Gamma(\mu+\nu) \Gamma(\frac{1}{2}-\mu)}{\Gamma(\frac{1}{2}) 2^\mu \Gamma(\nu-\mu+1)}$$

$$\left( \Re \mu < \frac{1}{2}, \Re(\mu+\nu) > 0 \right)$$

11.4.14

$$\int_0^\infty \cos bt K_0(t) dt = \frac{\frac{1}{2}\pi}{(1+b^2)^{\frac{1}{2}}} \quad (|\Im b| < 1)$$

11.4.15

$$\int_0^\infty \sin bt K_0(t) dt = \frac{\text{arc sinh } b}{(1+b^2)^{\frac{1}{2}}} \quad (|\Im b| < 1)$$

11.4.16

$$\int_0^\infty t^\mu J_\nu(t) dt = \frac{2^\mu \Gamma\left(\frac{\nu+\mu+1}{2}\right)}{\Gamma\left(\frac{\nu-\mu+1}{2}\right)}$$

$$\left( \Re(\mu+\nu) > -1, \Re \mu < \frac{1}{2} \right)$$

11.4.17

$$\int_0^\infty J_\nu(t) dt = 1 \quad (\Re \nu > -1)$$

11.4.18

$$\int_0^\infty \frac{[1-J_0(t)] dt}{t^\mu} = \frac{\Gamma\left(\frac{\mu-1}{2}\right) \Gamma\left(\frac{3-\mu}{2}\right)}{2^\mu \left\{ \Gamma\left(\frac{\mu+1}{2}\right) \right\}^2} \quad (1 < \Re \mu < 3)$$

11.4.19

$$\int_0^\infty t^\mu Y_\nu(t) dt = \frac{2^\mu}{\pi} \Gamma\left(\frac{\mu+\nu+1}{2}\right) \Gamma\left(\frac{\mu-\nu+1}{2}\right)$$

$$\times \sin \frac{\pi}{2} (\mu-\nu) \left( \Re(\mu\pm\nu) > -1, \Re \mu < \frac{1}{2} \right)$$

11.4.20

$$\int_0^\infty Y_\nu(t) dt = -\tan \frac{\nu\pi}{2} \quad (|\Re \nu| < 1)$$

11.4.21

$$\int_0^\infty Y_0(t) dt = 0$$

11.4.22

$$\int_0^\infty t^\mu K_\nu(t) dt = 2^{\mu-1} \Gamma\left(\frac{\mu+\nu+1}{2}\right) \Gamma\left(\frac{\mu-\nu+1}{2}\right)$$

$$\left( \Re(\mu\pm\nu) > -1 \right)$$

11.4.23

$$\int_0^\infty K_0(t) dt = \frac{\pi}{2}$$

11.4.24

$$\int_{-\infty}^\infty e^{-i\omega t} J_n(t) dt = \frac{2(-i)^n T_n(\omega)}{(1-\omega^2)^{\frac{1}{2}}} \quad (\omega^2 < 1)$$

$$= 0 \quad (\omega^2 > 1)$$

where  $T_n(\omega)$  is the Chebyshev polynomial of the first kind (see chapter 22).

11.4.25

$$\int_{-\infty}^\infty t^{-1} e^{-i\omega t} J_n(t) dt$$

$$= \frac{2i}{n} (-i)^n (1-\omega^2)^{\frac{1}{2}} U_{n-1}(\omega) \quad (\omega^2 < 1)$$

$$= 0 \quad (\omega^2 > 1)$$

where  $U_n(\omega)$  is the Chebyshev polynomial of the second kind (see chapter 22).

11.4.26

$$\int_{-\infty}^\infty t^{-\frac{1}{2}} e^{-i\omega t} J_{n+\frac{1}{2}}(t) dt = (-i)^n (2\pi)^{\frac{1}{2}} P_n(\omega) \quad (\omega^2 < 1)$$

$$= 0 \quad (\omega^2 > 1)$$

where  $P_n(\omega)$  is the Legendre polynomial (see chapter 22).

11.4.27

$$\int_0^\infty e^{-t} t^{\frac{a}{2}-1} J_a[2(zt)^{\frac{1}{2}}] dt = \frac{\gamma(a, z)}{z^{a/2}} \quad (\Re a > 0, \Re z > 0)$$

where  $\gamma(a, z)$  is the incomplete gamma function (see chapter 6).

Integrals of the Form  $\int_0^\infty e^{-a^2 t^2} t^\mu Z_\nu(bt) dt$ 

11.4.28

$$\int_0^\infty e^{-a^2 t^2} t^{\mu-1} J_\nu(bt) dt$$

$$= \frac{\Gamma\left(\frac{1}{2}\nu + \frac{1}{2}\mu\right) \left(\frac{1}{2}\frac{b}{a}\right)^\nu}{2a^\mu \Gamma(\nu+1)} M\left(\frac{1}{2}\nu + \frac{1}{2}\mu, \nu+1, -\frac{b^2}{4a^2}\right)$$

$$\left( \Re(\mu+\nu) > 0, \Re a^2 > 0 \right)$$

where the notation  $M(a, b, z)$  stands for the confluent hypergeometric function (see chapter 13).

11.4.29

$$\int_0^\infty e^{-a^2 t^2} t^{\nu+1} J_\nu(bt) dt$$

$$= \frac{b^\nu}{(2a^2)^{\nu+1}} e^{-\frac{b^2}{4a^2}} \quad (\Re \nu > -1, \Re a^2 > 0)$$

11.4.30

$$\int_0^\infty e^{-a^2 t} Y_{2\nu}(bt) dt = -\frac{\pi^{\frac{1}{2}}}{2a} e^{-\frac{b^2}{8a^2}} \left[ I_\nu \left( \frac{b^2}{8a^2} \right) \tan \nu\pi + \frac{1}{\pi} K_\nu \left( \frac{b^2}{8a^2} \right) \sec \nu\pi \right] \quad \left( |\Re \nu| < \frac{1}{2}, \Re a^2 > 0 \right)$$

11.4.31

$$\int_0^\infty e^{-a^2 t^2} I_\nu(bt) dt = \frac{\pi^{\frac{1}{2}}}{2a} e^{\frac{b^2}{8a^2}} I_{\frac{1}{2}\nu} \left( \frac{b^2}{8a^2} \right) \quad (\Re \nu > -1, \Re a^2 > 0)$$

11.4.32

$$\int_0^\infty e^{-a^2 t^2} K_0(bt) dt = \frac{\pi^{\frac{1}{2}}}{4a} e^{\frac{b^2}{8a^2}} K_0 \left( \frac{b^2}{8a^2} \right) \quad (\Re a^2 > 0)$$

Weber-Schafheitlin Type Integrals

11.4.33

$$\int_0^\infty \frac{J_\mu(at) J_\nu(bt) dt}{t^\lambda} = \frac{b^\nu \Gamma \left( \frac{\mu + \nu - \lambda + 1}{2} \right)}{2^\lambda a^{\nu - \lambda + 1} \Gamma(\nu + 1) \Gamma \left( \frac{\mu - \nu + \lambda + 1}{2} \right)} \times {}_2F_1 \left( \frac{\mu + \nu - \lambda + 1}{2}, \frac{\nu - \mu - \lambda + 1}{2}; \nu + 1; \frac{b^2}{a^2} \right) \quad (\Re(\mu + \nu - \lambda + 1) > 0, \Re \lambda > -1, 0 < b < a)$$

11.4.34

$$\int_0^\infty \frac{J_\mu(at) J_\nu(bt) dt}{t^\lambda} = \frac{a^\mu \Gamma \left( \frac{\mu + \nu - \lambda + 1}{2} \right)}{2^\lambda b^{\mu - \lambda + 1} \Gamma(\mu + 1) \Gamma \left( \frac{\nu - \mu + \lambda + 1}{2} \right)} \times {}_2F_1 \left( \frac{\mu + \nu - \lambda + 1}{2}, \frac{\mu - \nu - \lambda + 1}{2}; \mu + 1; \frac{a^2}{b^2} \right) \quad (\Re(\mu + \nu - \lambda + 1) > 0, \Re \lambda > -1, 0 < a < b)$$

For  ${}_2F_1$ , see chapter 15.

Special Cases of the Discontinuous Weber-Schafheitlin Integral

11.4.35

$$\int_0^\infty \frac{J_\mu(at) \sin bt}{t} dt = \frac{1}{\mu} \sin \left[ \mu \arcsin \frac{b}{a} \right] \quad (0 \leq b \leq a) \\ = \frac{a^\mu \sin \frac{\pi\mu}{2}}{\mu [b + (b^2 - a^2)^{\frac{1}{2}}]^\mu} \quad (b \geq a > 0) \\ (\Re \mu > -1)$$

11.4.36

$$\int_0^\infty \frac{J_\mu(at) \cos bt}{t} dt = \frac{1}{\mu} \cos \left[ \mu \arcsin \frac{b}{a} \right] \quad (0 \leq b \leq a) \\ = \frac{a^\mu \cos \frac{\pi\mu}{2}}{\mu [b + (b^2 - a^2)^{\frac{1}{2}}]^\mu} \quad (b \geq a > 0) \\ (\Re \mu > 0)$$

11.4.37

$$\int_0^\infty J_\mu(at) \cos bt dt = \frac{\cos \left[ \mu \arcsin \frac{b}{a} \right]}{(a^2 - b^2)^{\frac{1}{2}}} \quad (0 \leq b < a) \\ = \frac{-a^\mu \sin \frac{\pi\mu}{2}}{(b^2 - a^2)^{\frac{1}{2}} [b + (b^2 - a^2)^{\frac{1}{2}}]^\mu} \quad (b > a > 0) \quad (\Re \mu > -1)$$

11.4.38

$$\int_0^\infty J_\mu(at) \sin bt dt = \frac{\sin \left[ \mu \arcsin \frac{b}{a} \right]}{(a^2 - b^2)^{\frac{1}{2}}} \quad (0 \leq b < a) \\ = \frac{a^\mu \cos \frac{\pi\mu}{2}}{(b^2 - a^2)^{\frac{1}{2}} [b + (b^2 - a^2)^{\frac{1}{2}}]^\mu} \quad (b > a > 0) \quad (\Re \mu > -2)$$

11.4.39

$$\int_0^\infty e^{i\theta t} J_0(at) dt = \frac{1}{(a^2 - b^2)^{\frac{1}{2}}} \quad (0 \leq b < a) \\ = \frac{i}{(b^2 - a^2)^{\frac{1}{2}}} \quad (0 < a < b)$$

11.4.40

$$\int_0^\infty e^{i\theta t} Y_0(at) dt = \frac{2i}{\pi(a^2 - b^2)^{\frac{1}{2}}} \arcsin \frac{b}{a} \quad (0 \leq b < a) \\ = \frac{-1}{(b^2 - a^2)^{\frac{1}{2}}} + \frac{2i}{\pi(b^2 - a^2)^{\frac{1}{2}}} \\ \times \ln \left\{ \frac{b - (b^2 - a^2)^{\frac{1}{2}}}{a} \right\} \quad (0 < a < b)$$

11.4.41

$$\int_0^\infty t^{\mu - \nu + 1} J_\mu(at) J_\nu(bt) dt = 0 \quad (0 < b < a) \\ = \frac{2^{\mu - \nu + 1} a^\mu (b^2 - a^2)^{\nu - \mu - 1}}{b^\nu \Gamma(\nu - \mu)} \quad (b > a > 0) \\ (\Re \nu > \Re \mu > -1)$$

11.4.42

$$\int_0^\infty J_\mu(at) \mathcal{Y}_{\mu-1}(bt) dt = \frac{b^{\mu-1}}{a^\mu} \quad (0 < b < a) \\ = \frac{1}{2b} \quad (0 < b = a) \\ = 0 \quad (b > a > 0) \quad (\Re \mu > 0)$$

11.4.43

$$\int_0^\infty \frac{J_0(at)}{t} \{1 - J_0(bt)\} dt = 0 \quad (0 < b \leq a) \\ = \ln \frac{b}{a} \quad (b \geq a > 0)$$

## Hankel-Nicholson Type Integrals

11.4.44

$$\int_0^\infty \frac{t^{\nu+1} J_\nu(at) dt}{(t^2+z^2)^{\mu+1}} = \frac{a^\mu z^{\nu-\mu}}{2^\mu \Gamma(\mu+1)} K_{\nu-\mu}(az)$$

$$\left(a > 0, \Re z > 0, -1 < \Re \nu < 2\Re \mu + \frac{3}{2}\right)$$

11.4.45

$$\int_0^\infty \frac{J_\nu(at) dt}{t^\nu (t^2+z^2)} = \frac{\pi}{2z^{\nu+1}} [I_\nu(az) - L_\nu(az)]$$

$$\left(a > 0, \Re z > 0, \Re \nu > -\frac{5}{2}\right)$$

11.4.46

$$\int_0^\infty \frac{Y_0(at) dt}{t^2+z^2} = -\frac{K_0(az)}{z} \quad (a > 0, \Re z > 0)$$

11.4.47

$$\int_0^\infty \frac{K_\nu(at) dt}{t^\nu (t^2+z^2)} = \frac{\pi^2}{4z^{\nu+1} \cos \nu\pi} [\mathbf{H}_\nu(az) - Y_\nu(az)]$$

$$(\Re a > 0, \Re z > 0, \Re \nu < \frac{1}{2})$$

11.4.48

$$\int_0^\infty \frac{J_\nu(at) dt}{(t^2+z^2)^{\frac{1}{2}}} = I_{\frac{1}{2}\nu}(\frac{1}{2}az) K_{\frac{1}{2}\nu}(\frac{1}{2}az)$$

$$(a > 0, \Re z > 0, \Re \nu > -1)$$

11.4.49

$$\int_0^\infty \frac{J_\nu(at) dt}{t^\nu (t^2+z^2)^{\nu+\frac{1}{2}}} = \frac{\left(\frac{2a}{z^2}\right)^\nu \Gamma(\nu+1)}{\Gamma(2\nu+1)} I_\nu(\frac{1}{2}az) K_\nu(\frac{1}{2}az)$$

$$(a > 0, \Re z > 0, \Re \nu > -\frac{1}{2})$$

## Numerical Methods

## 11.5. Use and Extension of the Tables

$$\int_0^x J_0(t) dt, \int_0^x Y_0(t) dt, \int_0^x I_0(t) dt, \int_x^\infty K_0(t) dt$$

For moderate values of  $x$ , use 11.1.2 and 11.1.7-11.1.10 as appropriate. For  $x$  sufficiently large, use the asymptotic expansions or the polynomial approximations 11.1.11-11.1.18.

**Example 1.** Compute  $\int_0^{3.05} J_0(t) dt$  to 5D.

Using 11.1.2 and interpolating in Tables 9.1 and 9.2, we have

$$\int_0^{3.05} J_0(t) dt = 2[.32019 \ 09 + .31783 \ 69 + .04611 \ 52$$

$$+ .00283 \ 19 + .00009 \ 72 + .00000 \ 21]$$

$$= 1.37415$$

**Example 2.** Compute  $\int_0^{3.05} J_0(t) dt$  to 5D by interpolation of Table 11.1 using Taylor's formula. We have

$$\int_0^{x+h} J_0(t) dt = \int_0^x J_0(t) dt + hJ_0(x) - \frac{h^2}{2} J_1(x)$$

$$+ \frac{h^3}{12} [J_2(x) - J_0(x)] + \frac{h^4}{96} [3J_1(x) - J_3(x)] + \dots$$

Then with  $x=3.0$  and  $h=.05$ ,

$$\int_0^{3.05} J_0(t) dt = 1.387567 + (.05)(-.260052)$$

$$- (.00125)(.339059)$$

$$+ (.000010)(.746143) = 1.37415$$

This value is readily checked using  $x=3.1$  and  $h=-.05$ . Now  $|J_0(x)| \leq 1$  for all  $x$  and  $|J_n(x)| < 2^{-n}$ ,  $n \geq 1$  for all  $x$ . In Table 11.1, we can always choose  $|h| \leq .05$ . Thus if all terms of  $O(h^4)$  and higher are neglected, then a bound for the absolute error is  $2^4 h^4 / 48 < .2 \cdot 10^{-6}$  for all  $x$  if  $|h| \leq .05$ . Similarly, the absolute error for quadratic interpolation does not exceed

$$h^3(2^3+2)/24 < .2 \cdot 10^{-4}.$$

**Example 3.** Interpolation of  $\int_0^x J_0(t) dt$  using Simpson's rule. We have

$$\int_0^{x+h} J_0(t) dt = \int_0^x J_0(t) dt + \int_x^{x+h} J_0(t) dt$$

$$\int_x^{x+h} J_0(t) dt = \frac{h}{6} \left[ J_0(x) + 4J_0\left(x + \frac{h}{2}\right) + J_0(x+h) \right] + R$$

$$R = -\frac{h^5}{2880} J_0^{(4)}(\xi), \quad x < \xi < x+h$$

Now

$$J_0^{(4)}(x) = \frac{1}{8} [J_4(x) - 4J_2(x) + 3J_0(x)]$$

$$|J_0^{(4)}(x)| < \frac{6+5\sqrt{2}}{16} < .82$$

and with  $|h| \leq .05$ , it follows that

$$|R| < .9 \cdot 10^{-10}$$

Thus if  $x=3.0$  and  $h=.05$

$$\int_0^{3.05} J_0(t) dt = 1.38756 \ 72520 + \frac{(.05)}{6} [-.26005 \ 19549$$

$$+ 4(-.26841 \ 13883) - .27653 \ 49599]$$

$$= 1.37414 \ 86481$$



which is correct to 10D. The above procedure gives high accuracy though it may be necessary to interpolate twice in  $J_0(x)$  to compute  $J_0\left(x+\frac{h}{2}\right)$  and  $J_0(x+h)$ . A similar technique based on the trapezoidal rule is less accurate, but at most only one interpolation of  $J_0(x)$  is required.

**Example 4.** Compute  $\int_0^3 J_0(t)dt$  and  $\int_0^3 Y_0(t)dt$  to 5D using the representation in terms of Struve functions and the tables in chapters 9 and 12.

For  $x=3$ , from **Tables 9.1 and 12.1**

$$\begin{aligned} J_0 &= -.260052 & J_1 &= .339059 \\ Y_0 &= .376850 & Y_1 &= .324674 \\ H_0 &= .574306 & H_1 &= 1.020110 \end{aligned}$$

Using 11.1.7, we have

$$\begin{aligned} \int_0^3 J_0(t)dt &= 3(-.260052) + \frac{3\pi}{2} [(.574306)(.339059) \\ &\quad - (1.020110)(-.260052)] \\ &= 1.38757 \end{aligned}$$

Similarly,

$$\int_0^3 Y_0(t)dt = .19766$$

Using 11.1.8 and **Tables 9.8 and 12.1**, one can compute  $\int_0^x I_0(t)dt$  and  $\int_0^x K_0(t)dt$ .

$$\int_x^\infty \frac{J_0(t)dt}{t}, \int_x^\infty \frac{Y_0(t)dt}{t}, \int_0^x \frac{[I_0(t)-1]dt}{t}, \int_x^\infty \frac{K_0(t)dt}{t}$$

For moderate values of  $x$ , use 11.1.19–11.1.23. For  $x$  sufficiently large, use the asymptotic expansions or the polynomial approximations 11.1.24–11.1.31.

**Repeated Integrals of  $J_0(x)$**

For moderate values of  $x$  and  $r$ , use 11.2.4. If  $r=1$ , see **Example 1**. For moderate values of  $x$ , use the recurrence formula 11.2.5. If  $x$  is large and  $x \gg r$ , see the discussion below.

**Example 5.** Compute  $f_{r,0}(x) = f_r(x)$  to 5D for  $x=2$  and  $r=0(1)5$  using 11.2.6. We have

$$rf_{r+1}(x) = xf_r(x) - (r-1)f_{r-1}(x) + xf_{r-2}(x)$$

$$f_{-1}(x) = -J_1(x), f_0(x) = J_0(x), f_1(x) = \int_0^x J_0(t) dt$$

and the terms on this last line are tabulated. Thus for  $x=2$ ,

$$f_{-1} = -.57672 48, f_0 = .22389 08, f_1 = 1.42577 03$$

The recurrence formula gives

$$f_2 = 2(f_1 + f_{-1}) = 1.69809 10$$

Similarly,

$$f_3 = 1.20909 66, f_4 = .62451 73, f_5 = .25448 17$$

When  $x \gg r$ , it is convenient to use the auxiliary function

$$g_r(x) = (r-1)! x^{-r+1} f_r(x)$$

This satisfies the recurrence relation

$$\begin{aligned} x^2 g_{r+1}(x) &= x^2 g_r - (r-1)^2 g_{r-1}(x) \\ &\quad + (r-1)(r-2)g_{r-2}(x), r \geq 3 \end{aligned}$$

$$\begin{aligned} g_1(x) &= \int_0^x J_0(t)dt, g_2(x) = g_1(x) - J_1(x) \\ g_3(x) &= [x^2 g_2(x) - g_1(x) + xJ_0(x)]/x^2 \end{aligned}$$

**Example 6.** Compute  $g_r(x)$  to 5D for  $x=10$  and  $r=0(1)6$ . We have for  $x=10$ ,

$$J_0 = -.24593 58, J_1 = .04347 27, g_1 = 1.06701 13$$

Thus

$$g_2 = 1.02353 86, g_3 = .98827 49$$

and the forward recurrence formula gives

$$g_4 = .96867 36, g_5 = .94114 12, g_6 = .90474 64$$

For tables of  $2^{-r}f_r(x)$ , see [11.16].

**Repeated Integrals of  $K_0(x)$**

For moderate values of  $x$ , use the recurrence formula 11.2.14 for all  $r$ .

**Example 7.** Compute  $Ki_r(x)$  to 5D for  $x=2$  and  $r=0(1)5$ . We have

$$rKi_{r+1}(x) = -xKi_r(x) + (r-1)Ki_{r-1}(x) + xKi_{r-2}(x)$$

$$Ki_{-1}(x) = K_1(x), Ki_0(x) = K_0(x), Ki_1(x) = \int_x^\infty K_0(t)dt$$

and the functions on this last line are tabulated. Thus for  $x=2$ ,

$$K_0 = .11389 39, K_1 = .13986 59, Ki_1 = .09712 06$$

and

$$Ki_2 = -2Ki_1 + 2K_1 = .08549 06$$

Similarly,

$$Ki_3 = .07696 36, Ki_4 = .07043 17, Ki_5 = .06525 22$$

If  $x/r$  is not large the formula can still be used provided that the starting values are sufficiently accurate to offset the growth of rounding error.

For tables of  $Ki_r(x)$ , see [11.11].

$$f_m(x) = x^{-m} \int_0^x t^m K_0(t) dt$$

Now

$$f_0(x) = \int_0^x K_0(t) dt, f_1(x) = [1 - xK_1(x)]/x$$

the latter following from 11.3.27 with  $\nu=1$ . In 11.3.5, put  $a=1$ ,  $b=-1$ ,  $p=0$  and  $\nu=0$ . Let  $\mu=m$ . Then

$$f_m(x) = [(m-1)^2 f_{m-2}(x) - x^2 K_1(x) - x(m-1)K_0(x)]/x^2 \quad (m > 1)$$

Using tabular values of  $f_0$  and  $f_1$ , one can compute in succession  $f_2, f_3, \dots$  provided that  $m/x$  is not large.

**Example 8.** Compute  $f_m(x)$  to 5D for  $x=5$  and  $m=0(1)6$ . We have, retaining two additional decimals

$$K_0 = .00369 \ 11 \quad K_1 = .00404 \ 46$$

$$f_0 = 1.56738 \ 74 \quad f_1 = .19595 \ 54$$

Thus

$$f_2 = .05791 \ 27, f_4 = .01458 \ 93, f_6 = .00685 \ 36$$

Similarly starting with  $f_1$ , we can compute  $f_3$  and  $f_5$ .

If  $m > x$ , employ the recurrence formula in backward form and write

$$f_{m-2}(x) = [x^2 f_m(x) + x^2 K_1(x) + x(m-1)K_0(x)]/(m-1)^2$$

In the latter expression, replace  $f_m$  by  $g_m$ . Fix  $x$ . Take  $r > m$  and assume  $g_r = 0$ . Compute  $g_{r-2}, g_{r-4}$ , etc. Then

$$\lim_{r \rightarrow \infty} g_{r-2k}(x) = f_m(x), \quad m = r - 2k$$

Apart from round-off error, the value of  $r$  needed to achieve a stated accuracy for given  $x$  and  $m$  can be determined a priori. Let

$$\epsilon_r = |g_r - f_r|$$

Then

$$\epsilon_{r-2k} = \frac{x^{2k} \epsilon_r}{(r-1)^2 (r-3)^2 \dots (r-2k+1)^2}$$

$$\epsilon_r \leq [x^2 K_1(x) + x(r-1)K_0(x)]/(r-1)^2$$

since for  $x$  fixed,  $f_r(x)$  is positive and decreases as  $r$  increases.

**Example 9.** Compute  $f_m(x)$  to 5D for  $x=3$  and  $m=0(2)10$ . We have

$$K_0 = .03473 \ 95 \quad K_1 = .04015 \ 64$$

If  $r=16$ ,

$$\epsilon_{16} < .86 \cdot 10^{-2} \quad \epsilon_{10} < 1.4 \cdot 10^{-6}$$

Taking  $g_{16} = 0$ , we compute the following values of  $g_{14}, g_{12}, \dots, g_0$  by recurrence. Also recorded are the required values of  $f_m$  to 5D.

| $m$ | $g_m$      | $f_m$   |
|-----|------------|---------|
| 14  | .00855 42  |         |
| 12  | .01061 09  |         |
| 10  | .01325 05  | .01325  |
| 8   | .01751 39  | .01751  |
| 6   | .02548 09  | .02548  |
| 4   | .04447 31  | .04447  |
| 2   | .11936 90  | .11937  |
| 0   | 1.53994 71 | 1.53995 |

For tables of  $f_m(x)$ , see [11.21].

## References

- Texts**
- [11.1] H. Bateman and R. C. Archibald, A guide to tables of Bessel functions, *Math. Tables Aids Comp.* **1**, 247-252 (1943). See also Supplements I, II, IV, same journal, **1**, 403-404 (1943); **2**, 59 (1946); **2**, 190 (1946), respectively.
- [11.2] A. Erdélyi et al., Higher transcendental functions, vol. 2, ch. 7 (McGraw-Hill Book Co., Inc., New York, N.Y., 1953).
- [11.3] A. Erdélyi et al., Tables of integral transforms, vols. 1, 2 (McGraw-Hill Book Co., Inc., New York, N.Y., 1954).
- [11.4] W. Gröbner and N. Hofreiter, *Integraltafel, II Teil* (Springer-Verlag, Wien and Innsbruck, Austria, 1949-1950).
- [11.5] L. V. King, On the convection of heat from small cylinders in a stream of fluid, *Trans. Roy. Soc. London* **214A**, 373-432 (1914).
- [11.6] Y. L. Luke, Some notes on integrals involving Bessel functions, *J. Math. Phys.* **29**, 27-30 (1950).
- [11.7] Y. L. Luke, An associated Bessel function, *J. Math. Phys.* **31**, 131-138 (1952).
- [11.8] F. Oberhettinger, On some expansions for Bessel integral functions, *J. Research NBS* **59**, 197-201 (1957) RP 2786.
- [11.9] G. Petiau, *La théorie des fonctions de Bessel* (Centre National de la Recherche Scientifique, Paris, France, 1955).
- [11.10] G. N. Watson, *A treatise on the theory of Bessel functions*, 2d ed. (Cambridge Univ. Press, Cambridge, England, 1958).
- Tables**
- [11.11] W. G. Bickley and J. Nayler, A short table of the functions  $Ki_n(x)$ , from  $n=1$  to  $n=16$ . *Philos. Mag.* **7**, 20, 343-347 (1935).  $Ki_1(x) = \int_x^\infty K_0(t) dt$ ,  $Ki_n(x) = \int_x^\infty Ki_{n-1}(t) dt$ ,  $n=1(1)16$ ,  $x=0(.05).2$  (.1)2, 3, 9D.

- [11.12] V. R. Bursian and V. Fock, Table of the functions  $\int_x^\infty K_0(x) dx, \int_0^x I_0(x) dx, e^x \int_x^\infty K_0(x) dx, e^{-x} \int_0^x I_0(x) dx$ , Akad. Nauk, Leningrad, Inst. Fiz. Mat., Trudy (Travaux) 2, 6-10 (1931).  $\int_x^\infty K_0(t) dt, x=0(.1)12, 7D$ ;  $e^x \int_x^\infty K_0(t) dt, x=0(.1)16, 7D$ ;  $\int_0^x I_0(t) dt, x=0(.1)6, 7D$ ;  $e^{-x} \int_0^x I_0(t) dt, x=0(.1)16, 7D$ .
- [11.13] E. A. Chistova, Tablitsy funktsii Besselya ot deistvitel' nogo argumenta i integralov ot nikh (Izdat. Akad. Nauk SSSR., Moscow, U.S.S.R., 1958).  $J_n(x), Y_n(x), \int_x^\infty \frac{J_n(t)}{t} dt, \int_x^\infty \frac{Y_n(t)}{t} dt, n=0, 1; x=0(.001)15(.01)100, 7D$ . Also tabulated are auxiliary expressions to facilitate interpolation near the origin.
- [11.14] A. J. M. Hitchcock, Polynomial approximations to Bessel functions of order zero and one and to related functions, Math. Tables Aids Comp. 11, 86-88 (1957). Polynomial approximations for  $\int_0^x J_0(t) dt$  and  $\int_x^\infty K_0(t) dt$ .
- [11.15] C. W. Horton, A short table of Struve functions and of some integrals involving Bessel and Struve functions, J. Math. Phys. 29, 56-58 (1950).  $C_n(x) = \int_0^x t^n J_n(t) dt, n=1(1)4, x=0(.1)10, 4D$ ;  $D_n(x) = \int_0^x t^n \mathbf{H}_n(t) dt, n=0(1)4, x=0(.1)10, 4D$ , where  $\mathbf{H}_n(x)$  is Struve's function; see chapter 12.
- [11.16] J. C. Jaeger, Repeated integrals of Bessel functions and the theory of transients in filter circuits, J. Math. Phys. 27, 210-219 (1948).  $f_1(x) = \int_0^x J_0(t) dt, f_r(x) = \int_0^x f_{r-1}(t) dt, 2^{-r} f_r(x), r=1(1)7, x=0(1)24, 8D$ . Also  $\Phi_n(x) = \int_0^\infty J_0[2(xt)^{1/2}] J_n(t) dt, \Phi_n(x), \Phi_n(x), n=1(1)7, x=0(1)24, 4D$ .
- [11.17] L. N. Karmazina and E. A. Chistova, Tablitsy funktsii Besselya ot mnimogo argumenta i integralov ot nikh (Izdat. Akad. Nauk SSSR., Moscow, U.S.S.R., 1958).  $e^{-x} I_0(x), e^{-x} I_1(x), e^x K_0(x), e^x K_1(x), e^x, e^{-x} \int_0^x I_0(t) dt, e^x \int_x^\infty K_0(t) dt, x=0(.001)5(.005)15(.01)100, 7D$  except for  $e^x$  which is 7S. Also tabulated are auxiliary expressions to facilitate interpolation near the origin.
- [11.18] H. L. Knudsen, Bidrag til teorien for antenne-systemer med hel eller delvis rotations-symmetri. I (Kommission Has Teknisk Forlag, Copenhagen, Denmark, 1953).  $\int_0^x J_n(t) dt, n=0(1)8, x=0(.01)10, 5D$ . Also  $\int_0^x J_n(t) e^{i\alpha t} dt, \alpha=t, \alpha=x-t$ .
- [11.19] Y. L. Luke and D. Ufford, Tables of the function  $\bar{K}_0(x) = \int_0^x K_0(t) dt$ . Math. Tables Aids Comp. UMT 129.  $\bar{K}_0(x) = -[\gamma + \ln(x/2)] A_1(x) + A_2(x), A_1(x), A_2(x). x=0(.01)5(.05)1, 8D$ .
- [11.20] C. Mack and M. Castle, Tables of  $\int_0^x I_0(x) dx$  and  $\int_x^\infty K_0(x) dx$ , Roy. Soc. Unpublished Math. Table File No. 6.  $a=0(.02)2(.1)4, 9D$ .
- [11.21] G. M. Muller, Table of the function 
$$Kj_n(x) = x^{-n} \int_0^x u^n K_0(u) du,$$
 Office of Technical Services, U.S. Department of Commerce, Washington, D.C. (1954).  $n=0(1)31, x=0(.01)2(.02)5, 8S$ .
- [11.22] National Bureau of Standards, Tables of functions and zeros of functions, Applied Math. Series 37 (U.S. Government Printing Office, Washington, D.C., 1954). (1) pp. 21-31:  $\int_0^x J_0(t) dt, \int_0^x Y_0(t) dt, x=0(.01)10, 10D$ . (2) pp. 33-39:  $\int_x^\infty J_0(t) dt/t, x=0(.1)10(1)22, 10D$ ;  $F(x) = \int_x^\infty J_0(t) dt/t + \ln(x/2), x=0(.1)3, 10D$ ;  $F^{(n)}(x)/n!, x=10(1)22, n=0(1)13, 12D$ .
- [11.23] National Physical Laboratory, Integrals of Bessel functions, Roy. Soc. Unpublished Math. Table File No. 17.  $\int_0^x J_0(t) dt, \int_0^x Y_0(t) dt, x=0(.5)50, 10D$ .
- [11.24] M. Rothman, Table of  $\int_0^x I_0(x) dx$  for  $0(.1)20(1)25$ , Quart. J. Mech. Appl. Math. 2, 212-217 (1949). 8S-9S.
- [11.25] P. W. Schmidt, Tables of  $\int_0^x J_0(t) dt$  for large  $x$ , J. Math. Phys. 34, 169-172 (1955).  $x=10(.2)40, 6D$ .
- [11.26] G. N. Watson, A treatise on the theory of Bessel functions, 2d ed. (Cambridge Univ. Press, Cambridge, England, 1958). Table VIII, p. 752:  $\frac{1}{2} \int_0^x J_0(t) dt, \frac{1}{2} \int_0^x Y_0(t) dt, x=0(.02)1, 7D$ , with the first 16 maxima and minima of the integrals to 7D.



# 12. Struve Functions and Related Functions

MILTON ABRAMOWITZ<sup>1</sup>

## Contents

|  | Page |
|--|------|
| <b>Mathematical Properties . . . . .</b>   | 496  |
| 12.1. Struve Function $\mathbf{H}_\nu(z)$ . . . . .  | 496  |
| 12.2. Modified Struve Function $\mathbf{L}_\nu(z)$ . . . . .   | 498  |
| 12.3. Anger and Weber Functions . . . . .  | 498  |
| <b>Numerical Methods . . . . .</b>   | 499  |
| 12.4. Use and Extension of the Tables . . . . .  | 499  |
| <b>References . . . . .</b>  | 500  |
| <b>Table 12.1. Struve Functions (<math>0 \leq x \leq \infty</math>) . . . . .</b>  | 501  |
| $\mathbf{H}_0(x), \mathbf{H}_1(x), \int_0^x \mathbf{H}_0(t)dt, I_0(x) - \mathbf{L}_0(x), I_1(x) - \mathbf{L}_1(x), \int_0^x [I_0(t) - \mathbf{L}_0(t)]dt$<br>$(2/\pi) \int_x^\infty t^{-1} \mathbf{H}_0(t)dt, x=0(.1)5, 5D \text{ to } 7D$   |      |
| <b>Table 12.2. Struve Functions for Large Arguments . . . . .</b>  | 502  |
| $\mathbf{H}_0(x) - Y_0(x), \mathbf{H}_1(x) - Y_1(x), \int_0^x [\mathbf{H}_0(t) - Y_0(t)]dt - (2/\pi) \ln x$<br>$I_0(x) - \mathbf{L}_0(x), I_1(x) - \mathbf{L}_1(x), \int_0^x [\mathbf{L}_0(t) - I_0(t)]dt - (2/\pi) \ln x$<br>$\int_x^\infty [\mathbf{H}_0(t) - Y_0(t)]t^{-1}dt, x^{-1}=.2(-.01)0, 6D$ |      |

The author acknowledges the assistance of Bertha H. Walter in the preparation and checking of the tables.

<sup>1</sup> National Bureau of Standards. (Deceased.)

# 12. Struve Functions and Related Functions

## Mathematical Properties

### 12.1. Struve Function $\mathbf{H}_\nu(z)$

#### Differential Equation and General Solution

12.1.1

$$z^2 \frac{d^2 w}{dz^2} + z \frac{dw}{dz} + (z^2 - \nu^2)w = \frac{4(\frac{1}{2}z)^{\nu+1}}{\sqrt{\pi}\Gamma(\nu + \frac{1}{2})}$$

The general solution is

12.1.2  $w = aJ_\nu(z) + bY_\nu(z) + \mathbf{H}_\nu(z)$  ( $a, b$ , constants)

where  $z^{-\nu}\mathbf{H}_\nu(z)$  is an entire function of  $z$ .

#### Power Series Expansion

12.1.3

$$\mathbf{H}_\nu(z) = (\frac{1}{2}z)^{\nu+1} \sum_{k=0}^{\infty} \frac{(-1)^k (\frac{1}{2}z)^{2k}}{\Gamma(k + \frac{3}{2})\Gamma(k + \nu + \frac{3}{2})}$$

12.1.4  $\mathbf{H}_0(z) = \frac{2}{\pi} \left[ z - \frac{z^3}{1^2 \cdot 3^2} + \frac{z^5}{1^2 \cdot 3^2 \cdot 5^2} - \dots \right]$

12.1.5

$$\mathbf{H}_1(z) = \frac{2}{\pi} \left[ \frac{z^2}{1^2 \cdot 3} - \frac{z^4}{1^2 \cdot 3^2 \cdot 5} + \frac{z^6}{1^2 \cdot 3^2 \cdot 5^2 \cdot 7} - \dots \right]$$

#### Integral Representations

If  $\Re \nu > -\frac{1}{2}$ ,

12.1.6

$$\mathbf{H}_\nu(z) = \frac{2(\frac{1}{2}z)^\nu}{\sqrt{\pi}\Gamma(\nu + \frac{1}{2})} \int_0^1 (1-t^2)^{\nu-\frac{1}{2}} \sin(zt) dt$$

12.1.7  $= \frac{2(\frac{1}{2}z)^\nu}{\sqrt{\pi}\Gamma(\nu + \frac{1}{2})} \int_0^{\frac{\pi}{2}} \sin(z \cos \theta) \sin^{2\nu} \theta d\theta$

12.1.8  $= Y_\nu(z)$

$$+ \frac{2(\frac{1}{2}z)^\nu}{\sqrt{\pi}\Gamma(\nu + \frac{1}{2})} \int_0^\infty e^{-zt} (1+t^2)^{\nu-\frac{1}{2}} dt$$

$(|\arg z| < \frac{\pi}{2})$

#### Recurrence Relations

12.1.9  $\mathbf{H}_{\nu-1} + \mathbf{H}_{\nu+1} = \frac{2\nu}{z} \mathbf{H}_\nu + \frac{(\frac{1}{2}z)^\nu}{\sqrt{\pi}\Gamma(\nu + \frac{3}{2})}$

12.1.10  $\mathbf{H}_{\nu-1} - \mathbf{H}_{\nu+1} = 2\mathbf{H}'_\nu - \frac{(\frac{1}{2}z)^\nu}{\sqrt{\pi}\Gamma(\nu + \frac{3}{2})}$

12.1.11  $\mathbf{H}'_0 = (2/\pi) - \mathbf{H}_1$

12.1.12  $\frac{d}{dz} (z^\nu \mathbf{H}_\nu) = z^\nu \mathbf{H}_{\nu-1}$

12.1.13  $\frac{d}{dz} (z^{-\nu} \mathbf{H}_\nu) = \frac{1}{\sqrt{\pi} 2^\nu \Gamma(\nu + \frac{3}{2})} - z^{-\nu} \mathbf{H}_{\nu+1}$

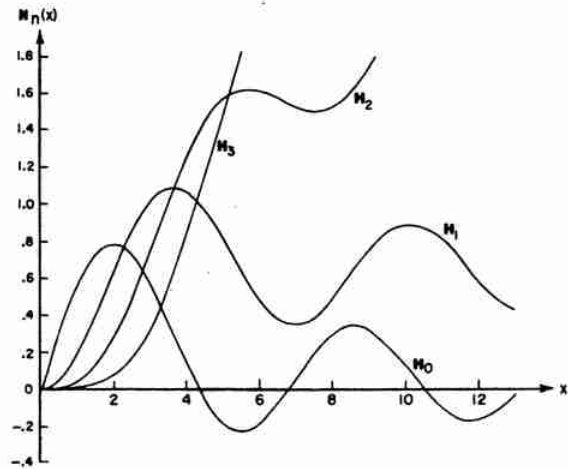

FIGURE 12.1. Struve functions.

$\mathbf{H}_n(x)$ ,  $n=0(1)3$

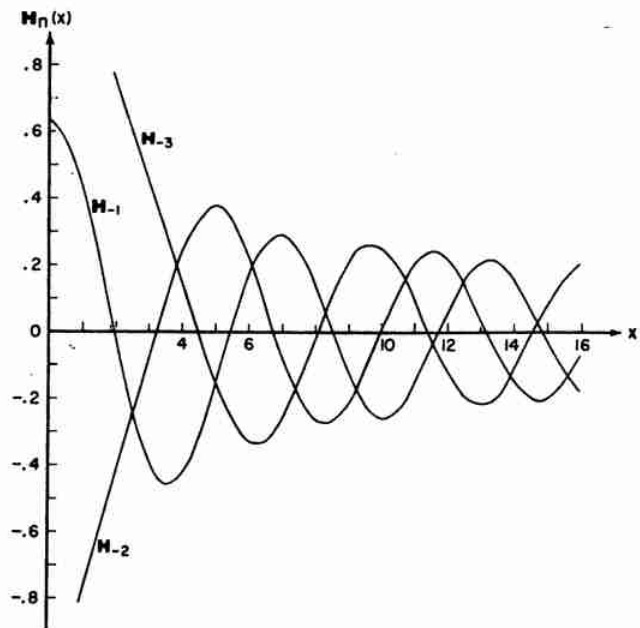

FIGURE 12.2. Struve functions.

$\mathbf{H}_n(x)$ ,  $-n=1(1)3$

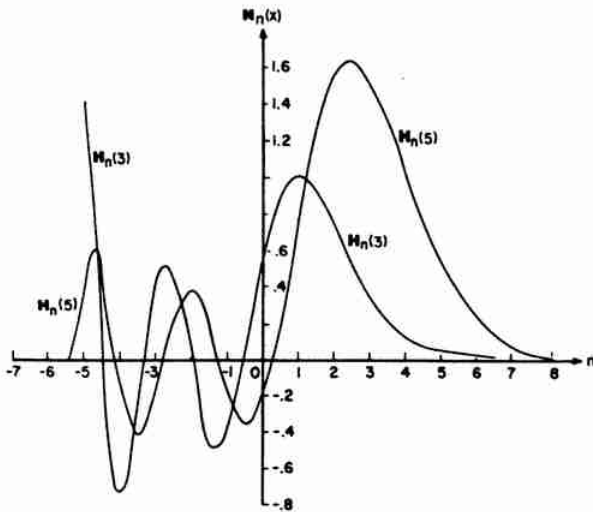

FIGURE 12.3. Struve functions.

$$H_n(x), x=3, 5$$

Special Properties

12.1.14  $H_\nu(x) \geq 0$  ( $x > 0$  and  $\nu \geq \frac{1}{2}$ )

12.1.15

$$H_{-(n+\frac{1}{2})}(z) = (-1)^n J_{n+\frac{1}{2}}(z) \quad (n \text{ an integer } \geq 0)$$

12.1.16  $H_1(z) = \left(\frac{2}{\pi z}\right)^{\frac{1}{2}} (1 - \cos z)$

12.1.17

$$H_1(z) = \left(\frac{z}{2\pi}\right)^{\frac{1}{2}} \left(1 + \frac{2}{z^2}\right) - \left(\frac{2}{\pi z}\right)^{\frac{1}{2}} \left(\sin z + \frac{\cos z}{z}\right)$$

12.1.18  $H_\nu(ze^{m\pi i}) = e^{m(\nu+1)\pi i} H_\nu(z)$  ( $m$  an integer)

12.1.19  $H_0(z) = \frac{4}{\pi} \sum_{k=0}^{\infty} \frac{J_{2k+1}(z)}{2k+1}$

12.1.20  $H_1(z) = \frac{2}{\pi} - \frac{2}{\pi} J_0(z) + \frac{4}{\pi} \sum_{k=1}^{\infty} \frac{J_{2k}(z)}{4k^2 - 1}$

12.1.21  $H_\nu(z) = \frac{2(z/2)^{\nu+1}}{\sqrt{\pi} \Gamma(\nu + \frac{3}{2})} {}_1F_2\left(1; \frac{3}{2} + \nu, \frac{3}{2}; -\frac{z^2}{4}\right)$

Integrals (See chapter 11)

12.1.22  $\int_0^\infty t^{-1} H_0(t) dt = \frac{\pi}{2}$

12.1.23

$$\int_0^z H_0(t) dt = \frac{2}{\pi} \left[ \frac{z^2}{2} - \frac{z^4}{1^2 \cdot 3^2 \cdot 4} + \frac{z^6}{1^2 \cdot 3^2 \cdot 5^2 \cdot 6} - \dots \right]$$

12.1.24  $\int_0^z t^{-\nu} H_{\nu+1}(t) dt = \frac{z}{2^\nu \sqrt{\pi} \Gamma(\nu + \frac{3}{2})} - z^{-\nu} H_\nu(z)$

Struve's Integral

12.1.25

$$\frac{4}{\pi} \int_z^\infty t^{-2} H_1(t) dt = \frac{2}{\pi z} H_1(z) + \frac{2}{\pi} \int_z^\infty t^{-1} H_0(t) dt$$

12.1.26

$$\frac{2}{\pi} \int_z^\infty t^{-1} H_0(t) dt = 1 - \frac{4}{\pi^2} \left[ z - \frac{z^3}{1^2 \cdot 3^2 \cdot 3} + \frac{z^5}{1^2 \cdot 3^2 \cdot 5^2 \cdot 5} - \dots \right]$$

12.1.27

$$\int_0^\infty t^{\mu-\nu-1} H_\nu(t) dt = \frac{\Gamma(\frac{1}{2}\mu) 2^{\mu-\nu-1} \tan(\frac{1}{2}\pi\mu)}{\Gamma(\nu - \frac{1}{2}\mu + 1)}$$

( $|\Re \mu| < 1, \Re \nu > \Re \mu - \frac{3}{2}$ )

If  $f_\nu(z) = \int_0^z H_\nu(t) t^\nu dt$

12.1.28

$$f_{\nu+1} = (2\nu+1)f_\nu(z) - z^{\nu+1} H_\nu(z)$$

$$+ \frac{z^{2\nu+2}}{(\nu+1)2^{\nu+1}\Gamma(\frac{1}{2})\Gamma(\nu+\frac{3}{2})} \quad (\Re \nu > -\frac{1}{2})$$

Asymptotic Expansions for Large  $|z|$

12.1.29

$$H_\nu(z) - Y_\nu(z) = \frac{1}{\pi} \sum_{k=0}^{m-1} \frac{\Gamma(k+\frac{1}{2})}{\Gamma(\nu+\frac{1}{2}-k)} \left(\frac{z}{2}\right)^{2k-\nu+1} + R_m$$

( $|\arg z| < \pi$ )

where  $R_m = O(|z|^{\nu-2m-1})$ . If  $\nu$  is real,  $z$  positive\* and  $m + \frac{1}{2} - \nu \geq 0$ , the remainder after  $m$  terms is of the same sign and numerically less than the first term neglected.

12.1.30

$$H_0(z) - Y_0(z) \sim \frac{2}{\pi} \left[ \frac{1}{z} - \frac{1}{z^3} + \frac{1^2 \cdot 3^2}{z^5} - \frac{1^2 \cdot 3^2 \cdot 5^2}{z^7} + \dots \right]$$

( $|\arg z| < \pi$ )

12.1.31

$$H_1(z) - Y_1(z) \sim \frac{2}{\pi} \left[ 1 + \frac{1}{z^2} - \frac{1^2 \cdot 3}{z^4} + \frac{1^2 \cdot 3^2 \cdot 5}{z^6} - \dots \right]$$

( $|\arg z| < \pi$ )

12.1.32

$$\int_0^z [H_0(t) - Y_0(t)] dt = \frac{2}{\pi} [\ln(2z) + \gamma]$$

$$\sim \frac{2}{\pi} \sum_{k=1}^{\infty} \frac{(-1)^{k+1} (2k)! (2k-1)!}{(k!)^2 (2z)^{2k}} \quad (|\arg z| < \pi)$$

where  $\gamma = .57721 56649 \dots$  is Euler's constant.

12.1.33

$$\int_z^\infty t^{-1} [H_0(t) - Y_0(t)] dt \sim \frac{2}{\pi z} \sum_{k=0}^{\infty} \frac{(-1)^k [(2k)!]^2}{(k!)^2 (2k+1) (2z)^{2k}}$$

( $|\arg z| < \pi$ )

\*See page 11.



Asymptotic Expansions for Large Orders

12.1.34

$$H_\nu(z) - Y_\nu(z) \sim \frac{2(\frac{1}{2}z)^\nu}{\sqrt{\pi}\Gamma(\nu+\frac{1}{2})} \sum_{k=0}^{\infty} \frac{k! b_k}{z^{k+1}} \quad (|\arg z| < \frac{1}{2}\pi, |\nu| < |z|)$$

$$b_0=1, b_1=2\nu/z, b_2=6(\nu/z)^2-\frac{1}{2}, b_3=20(\nu/z)^3-4(\nu/z)$$

12.1.35

$$H_\nu(z) + iJ_\nu(z) \sim \frac{2(\frac{1}{2}z)^\nu}{\sqrt{\pi}\Gamma(\nu+\frac{1}{2})} \sum_{k=0}^{\infty} \frac{k! b_k}{z^{k+1}} \quad (|\nu| > |z|)$$

12.2. Modified Struve Function  $L_\nu(z)$

Power Series Expansion

12.2.1  $L_\nu(z) = -ie^{-\frac{i\nu\pi}{2}} H_\nu(iz)$   

$$= (\frac{1}{2}z)^{\nu+1} \sum_{k=0}^{\infty} \frac{(z/2)^{2k}}{\Gamma(k+\frac{3}{2})\Gamma(k+\nu+\frac{3}{2})}$$

Integral Representations

12.2.2  $L_\nu(z) = \frac{2(z/2)^\nu}{\sqrt{\pi}\Gamma(\nu+\frac{1}{2})} \int_0^{\frac{\pi}{2}} \sinh(z \cos \theta) \sin^{2\nu} \theta d\theta$   
 $(\Re \nu > -\frac{1}{2})$

12.2.3

$$I_{-\nu}(x) - L_\nu(x) = \frac{2(x/2)^\nu}{\sqrt{\pi}\Gamma(\nu+\frac{1}{2})} \int_0^\infty \sin(tx)(1+t^2)^{\nu-1} dt \quad (\Re \nu < \frac{1}{2}, x > 0)$$

Recurrence Relations

12.2.4  $L_{\nu-1} - L_{\nu+1} = \frac{2\nu}{z} L_\nu + \frac{(z/2)^\nu}{\sqrt{\pi}\Gamma(\nu+\frac{3}{2})}$

12.2.5  $L_{\nu-1} + L_{\nu+1} = 2L'_\nu - \frac{(z/2)^\nu}{\sqrt{\pi}\Gamma(\nu+\frac{3}{2})}$

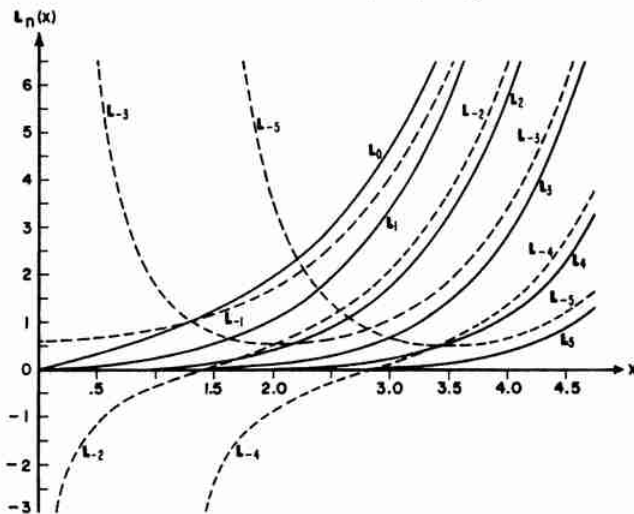

FIGURE 12.4. Modified Struve functions.

$$L_n(x), \pm n=0(1)5$$

\*See page II.

Asymptotic Expansion for Large  $|z|$

12.2.6

$$L_\nu(z) - I_{-\nu}(z) \sim \frac{1}{\pi} \sum_{k=0}^{\infty} \frac{(-1)^{k+1} \Gamma(k+\frac{1}{2})}{\Gamma(\nu+\frac{1}{2}-k) (\frac{z}{2})^{2k-\nu+1}} \quad (|\arg z| < \frac{1}{2}\pi)$$

Integrals

12.2.7

$$\int_0^z L_0(t) dt = \frac{2}{\pi} \left[ \frac{z^2}{2} + \frac{z^4}{1^2 \cdot 3^2 \cdot 4} + \frac{z^6}{1^2 \cdot 3^2 \cdot 5^2 \cdot 6} + \dots \right]$$

12.2.8

$$\int_0^z [I_0(t) - L_0(t)] dt = \frac{2}{\pi} [\ln(2z) + \gamma]$$

$$\sim -\frac{2}{\pi} \sum_{k=1}^{\infty} \frac{(2k)! (2k-1)!}{(k!)^2 (2z)^{2k}} \quad (|\arg z| < \frac{1}{2}\pi)$$

12.2.9

$$\int_0^z L_1(t) dt = L_0(z) - \frac{2}{\pi} z$$

Relation to Modified Spherical Bessel Function

12.2.10  $L_{-(n+\frac{1}{2})}(z) = I_{(n+\frac{1}{2})}(z) \quad (n \text{ an integer } \geq 0)$

12.3. Anger and Weber Functions

Anger's Function

12.3.1  $J_\nu(z) = \frac{1}{\pi} \int_0^\pi \cos(\nu\theta - z \sin \theta) d\theta$

12.3.2  $J_n(z) = J_n(z) \quad (n \text{ an integer})$

Weber's Function

12.3.3  $E_\nu(z) = \frac{1}{\pi} \int_0^\pi \sin(\nu\theta - z \sin \theta) d\theta$

Relations Between Anger's and Weber's Function

12.3.4  $\sin(\nu\pi) J_\nu(z) = \cos(\nu\pi) E_\nu(z) - E_{-\nu}(z)$

12.3.5  $\sin(\nu\pi) E_\nu(z) = J_{-\nu}(z) - \cos(\nu\pi) J_\nu(z)$

Relations Between Weber's Function and Struve's Function

If  $n$  is a positive integer or zero,

12.3.6  $E_n(z) = \frac{1}{\pi} \sum_{k=0}^{\lfloor \frac{n-1}{2} \rfloor} \frac{\Gamma(k+\frac{1}{2}) (\frac{1}{2}z)^{n-2k-1}}{\Gamma(n+\frac{1}{2}-k)} - H_n(z) \quad *$

12.3.7

$$E_{-n}(z) = \frac{(-1)^{n+1}}{\pi} \sum_{k=0}^{\lfloor \frac{n-1}{2} \rfloor} \frac{\Gamma(n-k-\frac{1}{2}) (\frac{1}{2}z)^{-n+2k+1}}{\Gamma(k+\frac{3}{2})} - H_{-n}(z) \quad *$$

12.3.8  $E_0(z) = -H_0(z)$

12.3.9  $E_1(z) = \frac{2}{\pi} H_1(z)$

12.3.10  $E_2(z) = \frac{2z}{3\pi} H_2(z)$

### Numerical Methods

#### 12.4. Use and Extension of the Tables

**Example 1.** Compute  $L_0(2)$  to 6D. From **Table 12.1**  $I_0(2) - L_0(2) = .342152$ ; from **Table 9.11** we have  $I_0(2) = 2.279585$  so that  $L_0(2) = 1.937433$ .

**Example 2.** Compute  $H_0(10)$  to 6D. From **Table 12.2** for  $x^{-1} = .1$ ,  $H_0(10) - Y_0(10) = .063072$ ; from **Table 9.1** we have  $Y_0(10) = .055671$ . Thus,  $H_0(10) = .118743$ .

**Example 3.** Compute  $\int_0^x H_0(t) dt$  for  $x=6$  to 5D. Using **Tables 12.2, 11.1** and **4.2**, we have  $\int_0^6 H_0(t) dt = \int_0^6 Y_0(t) dt + \frac{2}{\pi} \ln 6 + f_1(6)$   
 $= -.125951 + (.636620)(1.791759)$   
 $+ .816764$   
 $= 1.83148$

**Example 4.** Compute  $H_n(x)$  for  $x=4$ ,  $-n=0(1)8$  to 6S. From **Table 12.1** we have  $H_0(4) = .1350146$ ,  $H_1(4) = 1.0697267$ . Using **12.1.9** we find

|                        |                        |
|------------------------|------------------------|
| $H_{-1}(4) = -.433107$ | $H_{-8}(4) = .689652$  |
| $H_{-2}(4) = .240694$  | $H_{-6}(4) = -1.21906$ |
| $H_{-3}(4) = .152624$  | $H_{-7}(4) = 2.82066$  |
| $H_{-4}(4) = -.439789$ | $H_{-5}(4) = -8.24933$ |

**Example 5.** Compute  $H_n(x)$  for  $x=4$ ,  $n=0(1)10$  to 7S. Starting with the values of  $H_0(4)$  and  $H_1(4)$  and using **12.1.9** with forward recurrence, we get

|                       |                         |
|-----------------------|-------------------------|
| $H_0(4) = .13501 46$  | $H_6(4) = .05433 54$    |
| $H_1(4) = 1.06972 67$ | $H_7(4) = .01510 37$    |
| $H_2(4) = 1.24867 51$ | $H_8(4) = .00367 33$    |
| $H_3(4) = .85800 95$  | $H_9(4) = .00080 02$    |
| $H_4(4) = .42637 41$  | $H_{10}(4) = .00018 25$ |
| $H_5(4) = .16719 87$  |                         |

We note that for  $n > 6$  there is a rapid loss of significant figures. On the other hand using **12.1.3** for  $x=4$  we find  $H_4(4) = .0007935729$ ,  $H_{10}(4) = .00015447630$  and backward recurrence with **12.1.9** gives

|                        |                      |
|------------------------|----------------------|
| $H_8(4) = .00367 1495$ | $H_3(4) = .85800 94$ |
| $H_7(4) = .01510 315$  | $H_2(4) = 1.24867 6$ |
| $H_6(4) = .05433 519$  | $H_1(4) = 1.06972 7$ |
| $H_5(4) = .16719 87$   | $H_0(4) = .13501 4$  |
| $H_4(4) = .42637 43$   |                      |

**Example 6.** Compute  $L_n(.5)$  for  $n=0(1)5$  to 8S. From **12.2.1** we find  $L_5(.5) = 9.6307462 \times 10^{-7}$ ,  $L_4(.5) = 2.1212342 \times 10^{-5}$ . Then, with **12.2.4** we get

|                                       |                         |
|---------------------------------------|-------------------------|
| $L_3(.5) = 3.82465 03 \times 10^{-4}$ | $L_1(.5) = .05394 2181$ |
| $L_2(.5) = 5.36867 34 \times 10^{-3}$ | $L_0(.5) = .32724 068$  |

**Example 7.** Compute  $L_n(.5)$  for  $-n=0(1)5$  to 6S. From **Tables 12.1** and **9.8** we find  $L_0(.5) = .327240$ ,  $L_1(.5) = .053942$ . Then employing **12.2.4** with backward recurrence we get

|                         |                         |
|-------------------------|-------------------------|
| $L_{-1}(.5) = .690562$  | $L_{-4}(.5) = -75.1418$ |
| $L_{-2}(.5) = -1.16177$ | $L_{-5}(.5) = 1056.92$  |
| $L_{-3}(.5) = 7.43824$  |                         |

**Example 8.** Compute  $L_n(x)$  for  $x=6$  and  $-n=0(1)6$  to 8S. From **Tables 12.2** and **9.8** we find  $L_0(6) = 67.124454$ ,  $L_1(6) = 60.725011$ . Using **12.2.4** we get

|                         |                         |
|-------------------------|-------------------------|
| $L_{-1}(6) = 61.361631$ | $L_{-4}(6) = 16.626028$ |
| $L_{-2}(6) = 46.776680$ | $L_{-5}(6) = 7.984089$  |
| $L_{-3}(6) = 30.159494$ | $L_{-6}(6) = 3.32780$   |

We note that there is no essential loss of accuracy until  $n = -6$ . However, if further values were necessary the recurrence procedure becomes unstable. To avoid the instability use the methods described in **Examples 5** and **6**.

## References

## Texts

- [12.1] R. K. Cook, Some properties of Struve functions, *J. Washington Acad. Sci.* **47**, 11, 365-368 (1957).
- [12.2] A. Erdélyi et al., Higher transcendental functions, vol. 2, ch. 7 (McGraw-Hill Book Co., Inc., New York, N.Y., 1953).
- [12.3] A. Gray and G. B. Mathews, A treatise on Bessel functions, ch. 14 (The Macmillan Co., New York, N.Y., 1931).
- [12.4] N. W. McLachlan, Bessel functions for engineers, 2d ed. ch. 4 (Clarendon Press, Oxford, England, 1955).
- [12.5] F. Oberhettinger, On some expansions for Bessel integral functions, *J. Research NBS* **59** (1957) RP2786.
- [12.6] G. Petiau, La théorie des fonctions de Bessel, ch. 10 (Centre National de la Recherche Scientifique, Paris, France, 1955).
- [12.7] G. N. Watson, A treatise on the theory of Bessel functions, ch. 10 (Cambridge Univ. Press, Cambridge, England, 1958).

## Tables

- [12.8] M. Abramowitz, Tables of integrals of Struve functions, *J. Math. Phys.* **29**, 49-51 (1950).
- [12.9] C. W. Horton, On the extension of some Lommel integrals to Struve functions with an application to acoustic radiation, *J. Math. Phys.* **29**, 31-37 (1950).
- [12.10] C. W. Horton, A short table of Struve functions and of some integrals involving Bessel and Struve functions, *J. Math. Phys.* **29**, 56-58 (1950).
- [12.11] Mathematical Tables Project, Table of the Struve functions  $L(x)$  and  $H(x)$ , *J. Math. Phys.* **25**, 252-259 (1946).

**Table 12.2** **STRUVE FUNCTIONS FOR LARGE ARGUMENTS**

| $x^{-1}$ | $H_0(x) - Y_0(x)$   | $H_1(x) - Y_1(x)$   | $f_1(x)$  | $I_0(x) - L_0(x)$   | $I_1(x) - L_1(x)$   | $f_2(x)$  | $f_3(x)$  | $\langle x \rangle$ |
|----------|---|---|---|---|---|---|---|---------------------|
| 0.20     | 0.123301  | 0.659949  | 0.819924  | 0.133955  | 0.607426  | 0.793280  | 0.125868  | 5                   |
| 0.19     | 0.117449  | 0.657819  | 0.818935  | 0.126683  | 0.610467  | 0.794902  | 0.119694  | 5                   |
| 0.18     | 0.111556  | 0.655774  | 0.817981  | 0.119468  | 0.613348  | 0.796448  | 0.113505  | 6                   |
| 0.17     | 0.105625  | 0.653818  | 0.817062  | 0.112319  | 0.616060  | 0.797910  | 0.107299  | 6                   |
| 0.16     | 0.099655  | 0.651952  | 0.816182  | 0.105242  | 0.618598  | 0.799279  | 0.101079  | 6                   |
| 0.15     | 0.093647  | 0.650180  | 0.815341  | 0.098241  | 0.620955  | 0.800551  | 0.094843  | 7                   |
| 0.14     | 0.087602  | 0.648504  | 0.814541  | 0.091318  | 0.623129  | 0.801721  | 0.088593  | 7                   |
| 0.13     | 0.081521  | 0.646927  | 0.813785  | 0.084474  | 0.625119  | 0.802787  | 0.082328  | 8                   |
| 0.12     | 0.075404  | 0.645452  | 0.813074  | 0.077706  | 0.626927  | 0.803750  | 0.076051  | 8                   |
| 0.11     | 0.069254  | 0.644081  | 0.812411  | 0.071010  | 0.628558  | 0.804611  | 0.069761  | 9                   |
| 0.10     | 0.063072  | 0.642817  | 0.811796  | 0.064379  | 0.630018  | 0.805374  | 0.063460  | 10                  |
| 0.09     | 0.056860  | 0.641663  | 0.811232  | 0.057805  | 0.631315  | 0.806047  | 0.057147  | 11                  |
| 0.08     | 0.050620  | 0.640622  | 0.810722  | 0.051279  | 0.632457  | 0.806634  | 0.050824  | 13                  |
| 0.07     | 0.044354  | 0.639696  | 0.810266  | 0.044793  | 0.633450  | 0.807140  | 0.044492  | 14                  |
| 0.06     | 0.038064  | 0.638888  | 0.809866  | 0.038340  | 0.634302  | 0.807572  | 0.038152  | 17                  |
| 0.05     | 0.031753  | 0.638200  | 0.809525  | 0.031912  | 0.635016  | 0.807933  | 0.031805  | 20                  |
| 0.04     | 0.025425  | 0.637634  | 0.809244  | 0.025506  | 0.635596  | 0.808225  | 0.025451  | 25                  |
| 0.03     | 0.019082  | 0.637191  | 0.809023  | 0.019116  | 0.636045  | 0.808450  | 0.019093  | 33                  |
| 0.02     | 0.012727  | 0.636874  | 0.808865  | 0.012738  | 0.636365  | 0.808611  | 0.012731  | 50                  |
| 0.01     | 0.006366  | 0.636683  | 0.808770  | 0.006367  | 0.636556  | 0.808706  | 0.006366  | 100                 |
| 0.00     | 0.000000  | 0.636620  | 0.808738  | 0.000000  | 0.636620  | 0.808738  | 0.000000  | $\infty$            |
|          | $\left[ \begin{smallmatrix} (-6)5 \\ 3 \end{smallmatrix} \right]$ | $\left[ \begin{smallmatrix} (-5)2 \\ 3 \end{smallmatrix} \right]$ | $\left[ \begin{smallmatrix} (-6)8 \\ 3 \end{smallmatrix} \right]$ | $\left[ \begin{smallmatrix} (-5)1 \\ 3 \end{smallmatrix} \right]$ | $\left[ \begin{smallmatrix} (-5)2 \\ 3 \end{smallmatrix} \right]$ | $\left[ \begin{smallmatrix} (-5)1 \\ 3 \end{smallmatrix} \right]$ | $\left[ \begin{smallmatrix} (-6)2 \\ 3 \end{smallmatrix} \right]$ |                     |

$$\int_0^x [H_0(t) - Y_0(t)] dt = \frac{2}{\pi} \ln x + f_1(x)$$

$$\int_0^x [L_0(t) - I_0(t)] dt = \frac{2}{\pi} \ln x + f_2(x)$$

$$\int_x^\infty \left[ \frac{H_0(t) - Y_0(t)}{t} \right] dt = f_3(x)$$

$\langle x \rangle =$  nearest integer to  $x$ .

Starting with  $H_0(x)$  and  $H_1(x)$ , recurrence formula 12.1.9 may be used to generate  $H_n(x)$  for  $n < 0$ . As long as  $n < x/2$  (approx.),  $H_n(x)$  may be generated by forward recurrence. When  $n > x/2$ , forward recurrence is unstable. To avoid the instability, choose  $n > x$ , compute  $H_n(x)$  and  $H_{n+1}(x)$  with 12.1.3, and then use backward recurrence with 12.1.9.

If  $n > 0$ ,  $L_n(x)$  must be generated by backward recurrence. If  $n < 0$ ,  $L_n(x)$  may be generated by backward recurrence as long as  $L_n(x)$  increases. If  $n < 0$  and  $L_n(x)$  is decreasing, forward recurrence should be used.

See Examples 4-8.



# 13. Confluent Hypergeometric Functions

LUCY JOAN SLATER<sup>1</sup>

## Contents

|   | Page |
|---|------|
| <b>Mathematical Properties</b> . . . . .                                    | 504  |
| 13.1. Definitions of Kummer and Whittaker Functions . . . . .               | 504  |
| 13.2. Integral Representations . . . . .                                    | 505  |
| 13.3. Connections With Bessel Functions . . . . .                           | 506  |
| 13.4. Recurrence Relations and Differential Properties . . . . .            | 506  |
| 13.5. Asymptotic Expansions and Limiting Forms . . . . .                    | 508  |
| 13.6. Special Cases . . . . .   | 509  |
| 13.7. Zeros and Turning Values . . . . .                                    | 510  |
| <b>Numerical Methods</b> . . . . .  | 511  |
| 13.8. Use and Extension of the Tables . . . . .                             | 511  |
| 13.9. Calculation of Zeros and Turning Points . . . . .                     | 513  |
| 13.10. Graphing $M(a, b, x)$ . . . . .                                      | 513  |
| <b>References</b> . . . . .   | 514  |
| <b>Table 13.1.</b> Confluent Hypergeometric Function $M(a, b, x)$ . . . . . | 516  |
| $x=.1(.1)1(1)10, a=-1(.1)1, b=.1(.1)1, 8S$                                  |      |
| <b>Table 13.2.</b> Zeros of $M(a, b, x)$ . . . . .                          | 535  |
| $a=-1(.1)-.1, b=.1(.1)1, 7D$  |      |

The tables were calculated by the author on the electronic calculator EDSACI in the Mathematical Laboratory of Cambridge University, by kind permission of its director, Dr. M. V. Wilkes. The table of  $M(a, b, x)$  was recomputed by Alfred E. Beam for uniformity to eight significant figures.

<sup>1</sup> University Mathematical Laboratory, Cambridge. (Prepared under contract with the National Bureau of Standards.)

# 13. Confluent Hypergeometric Functions

## Mathematical Properties

### 13.1. Definitions of Kummer and Whittaker Functions

#### Kummer's Equation

$$13.1.1 \quad z \frac{d^2 w}{dz^2} + (b-z) \frac{dw}{dz} - aw = 0$$

It has a regular singularity at  $z=0$  and an irregular singularity at  $\infty$ .

Independent solutions are

#### Kummer's Function

### 13.1.2

$$M(a, b, z) = 1 + \frac{az}{b} + \frac{(a)_2 z^2}{(b)_2 2!} + \dots + \frac{(a)_n z^n}{(b)_n n!} + \dots$$

where

$$(a)_n = a(a+1)(a+2) \dots (a+n-1), (a)_0 = 1,$$

and

### 13.1.3

$$U(a, b, z) = \frac{\pi}{\sin \pi b} \left\{ \frac{M(a, b, z)}{\Gamma(1+a-b)\Gamma(b)} - z^{1-b} \frac{M(1+a-b, 2-b, z)}{\Gamma(a)\Gamma(2-b)} \right\}$$

*Parameters*  
( $m, n$  positive integers)

$$b \neq -n \quad a \neq -m$$

$$b \neq -n \quad a = -m$$

$$b = -n \quad a \neq -m$$

$$b = -n \quad a = -m, \\ m > n$$

$$b = -n \quad a = -m, \\ m \leq n$$

$U(a, b, z)$  is defined even when  $b \rightarrow \pm n$

As  $|z| \rightarrow \infty$ ,

### 13.1.4

$$M(a, b, z) = \frac{\Gamma(b)}{\Gamma(a)} e^z z^{a-b} [1 + O(|z|^{-1})] \quad (\Re z > 0)$$

and

### 13.1.5

$$M(a, b, z) = \frac{\Gamma(b)}{\Gamma(b-a)} (-z)^{-a} [1 + O(|z|^{-1})] \quad (\Re z < 0)$$

$U(a, b, z)$  is a many-valued function. Its principal branch is given by  $-\pi < \arg z \leq \pi$ .

#### Logarithmic Solution

### 13.1.6

$$U(a, n+1, z) = \frac{(-1)^{n+1}}{n! \Gamma(a-n)} \left[ M(a, n+1, z) \ln z + \sum_{r=0}^n \frac{(a)_r z^r}{(n+1)_r r!} \{ \psi(a+r) - \psi(1+r) - \psi(1+n+r) \} \right] + \frac{(n-1)!}{\Gamma(a)} z^{-n} M(a-n, 1-n, z)_n$$

for  $n=0, 1, 2, \dots$ , where the last function is the sum to  $n$  terms. It is to be interpreted as zero when  $n=0$ , and  $\psi(a) = \Gamma'(a)/\Gamma(a)$ .

$$13.1.7 \quad U(a, 1-n, z) = z^n U(a+n, 1+n, z)$$

As  $\Re z \rightarrow \infty$

$$13.1.8 \quad U(a, b, z) = z^{-a} [1 + O(|z|^{-1})]$$

#### Analytic Continuation

### 13.1.9

$$U(a, b, ze^{\pm \pi i}) = \frac{\pi}{\sin \pi b} e^{-z} \left\{ \frac{M(b-a, b, z)}{\Gamma(1+a-b)\Gamma(b)} - \frac{e^{\pm \pi i(1-b)} z^{1-b} M(1-a, 2-b, z)}{\Gamma(a)\Gamma(2-b)} \right\}$$

where either upper or lower signs are to be taken throughout.

### 13.1.10

$$U(a, b, ze^{2\pi i n}) = [1 - e^{-2\pi i b n}] \frac{\Gamma(1-b)}{\Gamma(1+a-b)} M(a, b, z) + e^{-2\pi i b n} U(a, b, z)$$

#### Alternative Notations

$${}_1F_1(a; b; z) \text{ or } \Phi(a; b; z) \text{ for } M(a, b, z)$$

$$z^{-a} {}_2F_0(a, 1+a-b; ; -1/z) \text{ or } \Psi(a; b; z) \text{ for } U(a, b, z)$$

#### Complete Solution

$$13.1.11 \quad y = AM(a, b, z) + BU(a, b, z)$$

where  $A$  and  $B$  are arbitrary constants,  $b \neq -n$ .

#### Eight Solutions

$$13.1.12 \quad y_1 = M(a, b, z)$$

$$13.1.13 \quad y_2 = z^{1-b} M(1+a-b, 2-b, z)$$

$$13.1.14 \quad y_3 = e^z M(b-a, b, -z)$$



13.1.15  $y_4 = z^{1-b} e^z M(1-a, 2-b, -z)$

13.1.16  $y_5 = U(a, b, z)$

13.1.17  $y_6 = z^{1-b} U(1+a-b, 2-b, z)$

13.1.18  $y_7 = e^z U(b-a, b, -z)$

13.1.19  $y_8 = z^{1-b} e^z U(1-a, 2-b, -z)$

**Wronskians**

If  $W\{m, n\} = y_m y'_n - y'_m y_n$  and  
 $\epsilon = \text{sgn}(\mathcal{I}z) = 1$  if  $\mathcal{I}z > 0$ ,  
 $= -1$  if  $\mathcal{I}z \leq 0$

13.1.20

$W\{1, 2\} = W\{3, 4\} = W\{1, 4\} = -W\{2, 3\}$   
 $= (1-b)z^{-b} e^z$

13.1.21

$W\{1, 3\} = W\{2, 4\} = W\{5, 6\} = W\{7, 8\} = 0$

13.1.22  $W\{1, 5\} = -\Gamma(b)z^{-b} e^z / \Gamma(a)$

13.1.23  $W\{1, 7\} = \Gamma(b) e^{\epsilon \pi i b} z^{-b} e^z / \Gamma(b-a)$

13.1.24  $W\{2, 5\} = -\Gamma(2-b)z^{-b} e^z / \Gamma(1+a-b)$

13.1.25  $W\{2, 7\} = -\Gamma(2-b)z^{-b} e^z / \Gamma(1-a)$

13.1.26  $W\{5, 7\} = e^{\epsilon \pi i (b-a)} z^{-b} e^z$

**Kummer Transformations**

13.1.27  $M(a, b, z) = e^z M(b-a, b, -z)$

13.1.28

$z^{1-b} M(1+a-b, 2-b, z) = z^{1-b} e^z M(1-a, 2-b, -z)$

13.1.29  $U(a, b, z) = z^{1-b} U(1+a-b, 2-b, z)$

13.1.30

$e^z U(b-a, b, -z) = e^{\epsilon \pi i (1-b)} e^z z^{1-b} U(1-a, 2-b, -z)$

**Whittaker's Equation**

13.1.31  $\frac{d^2 w}{dz^2} + \left[ -\frac{1}{4} + \frac{\kappa}{z} + \frac{(\frac{1}{2} - \mu^2)}{z^2} \right] w = 0$

Solutions:

**Whittaker's Functions**

13.1.32  $M_{\kappa, \mu}(z) = e^{-\frac{1}{2}z} z^{\frac{1}{2}+\mu} M(\frac{1}{2}+\mu-\kappa, 1+2\mu, z)$

13.1.33

$W_{\kappa, \mu}(z) = e^{-\frac{1}{2}z} z^{\frac{1}{2}+\mu} U(\frac{1}{2}+\mu-\kappa, 1+2\mu, z)$   
 $(-\pi < \arg z \leq \pi, \kappa = \frac{1}{2}b-a, \mu = \frac{1}{2}b-\frac{1}{2})$

13.1.34

$W_{\kappa, \mu}(z) = \frac{\Gamma(-2\mu)}{\Gamma(\frac{1}{2}-\mu-\kappa)} M_{\kappa, \mu}(z) + \frac{\Gamma(2\mu)}{\Gamma(\frac{1}{2}+\mu-\kappa)} M_{\kappa, -\mu}(z)$

**General Confluent Equation**

13.1.35

$w'' + \left[ \frac{2A}{Z} + 2f' + \frac{bh'}{h} - h' - \frac{h''}{h'} \right] w'$   
 $+ \left[ \left( \frac{bh'}{h} - h' - \frac{h''}{h'} \right) \left( \frac{A}{Z} + f' \right) + \frac{A(A-1)}{Z^2} \right. \\ \left. + \frac{2Af'}{Z} + f'' + f'^2 - \frac{ah'^2}{h} \right] w = 0$

Solutions:

13.1.36  $Z^{-A} e^{-f(Z)} M(a, b, h(Z))$

13.1.37  $Z^{-A} e^{-f(Z)} U(a, b, h(Z))$

**13.2. Integral Representations**

$\Re b > \Re a > 0$

13.2.1

$\frac{\Gamma(b-a)\Gamma(a)}{\Gamma(b)} M(a, b, z)$   
 $= \int_0^1 e^{zt} t^{a-1} (1-t)^{b-a-1} dt$

13.2.2

$= 2^{1-b} e^{\frac{1}{2}z} \int_{-1}^{+1} e^{-zt} (1+t)^{b-a-1} (1-t)^{a-1} dt$

13.2.3

$= 2^{1-b} e^{\frac{1}{2}z} \int_0^\pi e^{-iz \cos \theta} \sin^{b-1} \theta \cot^{b-2a}(\frac{1}{2}\theta) d\theta$

13.2.4

$= e^{-Az} \int_A^B e^{zt} (t-A)^{a-1} (B-t)^{b-a-1} dt$   
 $(A=B-1)$   
 $\Re a > 0, \Re z > 0$

13.2.5

$\Gamma(a) U(a, b, z) = \int_0^\infty e^{-zt} t^{a-1} (1+t)^{b-a-1} dt$

13.2.6

$= e^z \int_1^\infty e^{-zt} (t-1)^{a-1} t^{b-a-1} dt$

13.2.7

$= 2^{1-b} e^{\frac{1}{2}z} \int_0^\infty e^{-\frac{1}{2}z \cosh \theta} \sinh^{b-1} \theta \coth^{b-2a}(\frac{1}{2}\theta) d\theta$  \*

\*See page II.

13.2.8  $\Gamma(a)U(a, b, z)$

$$= e^{Az} \int_A^\infty e^{-zt}(t-A)^{a-1}(t+B)^{b-a-1} dt$$

$$(A=1-B)$$

Similar integrals for  $M_{\kappa, \mu}(z)$  and  $W_{\kappa, \mu}(z)$  can be deduced with the help of 13.1.32 and 13.1.33.

Barnes-type Contour Integrals

13.2.9

$$\frac{\Gamma(a)}{\Gamma(b)} M(a, b, z) = \frac{1}{2\pi i} \int_{c-i\infty}^{c+i\infty} \frac{\Gamma(-s)\Gamma(a+s)}{\Gamma(b+s)} (-z)^s ds$$

for  $|\arg(-z)| < \frac{1}{2}\pi$ ,  $a, b \neq 0, -1, -2, \dots$ . The contour must separate the poles of  $\Gamma(-s)$  from those of  $\Gamma(a+s)$ ;  $c$  is finite.

13.2.10

$$\Gamma(a)\Gamma(1+a-b)z^a U(a, b, z)$$

$$= \frac{1}{2\pi i} \int_{c-i\infty}^{c+i\infty} \Gamma(-s)\Gamma(a+s)\Gamma(1+a-b+s)z^{-s} ds$$

for  $|\arg z| < \frac{3\pi}{2}$ ,  $a \neq 0, -1, -2, \dots$ ,  $b-a \neq 1, 2, 3, \dots$ . The contour must separate the poles of  $\Gamma(-s)$  from those of  $\Gamma(a+s)$  and  $\Gamma(1+a-b+s)$ .

13.3. Connections With Bessel Functions  
(see chapters 9 and 10)

Bessel Functions as Limiting Cases

If  $b$  and  $z$  are fixed,

13.3.1  $\lim_{a \rightarrow \infty} \{M(a, b, z/a)/\Gamma(b)\} = z^{\frac{1}{2}-ib} I_{b-1}(2\sqrt{z})$

13.3.2  $\lim_{a \rightarrow \infty} \{M(a, b, -z/a)/\Gamma(b)\} = z^{\frac{1}{2}-ib} J_{b-1}(2\sqrt{z})$

13.3.3

$$\lim_{a \rightarrow \infty} \{\Gamma(1+a-b)U(a, b, z/a)\} = 2z^{\frac{1}{2}-ib} K_{b-1}(2\sqrt{z})$$

13.3.4

$$\lim_{a \rightarrow \infty} \{\Gamma(1+a-b)U(a, b, -z/a)\}$$

$$= -\pi i e^{\pi i b} z^{\frac{1}{2}-ib} H_{b-1}^{(1)}(2\sqrt{z}) \quad (\mathcal{I}z > 0)$$

13.3.5  $= \pi i e^{-\pi i b} z^{\frac{1}{2}-ib} H_{b-1}^{(2)}(2\sqrt{z}) \quad (\mathcal{I}z < 0)$

Expansions in Series

13.3.6

$$M(a, b, z) = e^{\frac{1}{2}z} \Gamma(b-a-\frac{1}{2}) (\frac{1}{4}z)^{a-b+\frac{1}{2}}$$

$$* \sum_{n=0}^{\infty} \frac{(2b-2a-1)_n (b-2a)_n (b-a-\frac{1}{2}+n)}{n! (b)_n} (-1)^n I_{b-a-\frac{1}{2}+n}(\frac{1}{2}z) \quad (b \neq 0, -1, -2, \dots)$$

13.3.7

$$\frac{M(a, b, z)}{\Gamma(b)} = e^{\frac{1}{2}z} (\frac{1}{2}bz - az)^{\frac{1}{2}-ib}$$

$$\cdot \sum_{n=0}^{\infty} A_n (\frac{1}{2}z)^{in} (b-2a)^{-in} J_{b-1+in}(\sqrt{(2zb-4za)})$$

where

$$A_0=1, A_1=0, A_2=\frac{1}{2}b,$$

$$(n+1)A_{n+1} = (n+b-1)A_{n-1} + (2a-b)A_{n-2},$$

(a real)

13.3.8

$$\frac{M(a, b, z)}{\Gamma(b)}$$

$$= e^{hz} \sum_{n=0}^{\infty} C_n z^n (-az)^{\frac{1}{2}(1-b-n)} J_{b-1+n}(2\sqrt{-az})$$

where

$$C_0=1, C_1=-bh, C_2=-\frac{1}{2}(2h-1)a + \frac{1}{2}b(b+1)h^2,$$

$$(n+1)C_{n+1} = [(1-2h)n - bh]C_n$$

$$+ [(1-2h)a - h(h-1)(b+n-1)]C_{n-1}$$

$$- h(h-1)aC_{n-2} \quad (h \text{ real})$$

13.3.9  $M(a, b, z) = \sum_{n=0}^{\infty} C_n(a, b) I_n(z)$

where

$$C_0=1, C_1(a, b) = 2a/b,$$

$$C_{n+1}(a, b) = 2aC_n(a+1, b+1)/b - C_{n-1}(a, b)$$

13.4. Recurrence Relations and Differential Properties

13.4.1

$$(b-a)M(a-1, b, z) + (2a-b+z)M(a, b, z)$$

$$- aM(a+1, b, z) = 0$$

13.4.2

$$b(b-1)M(a, b-1, z) + b(1-b-z)M(a, b, z)$$

$$+ z(b-a)M(a, b+1, z) = 0$$

13.4.3

$$(1+a-b)M(a, b, z) - aM(a+1, b, z)$$

$$+ (b-1)M(a, b-1, z) = 0$$

13.4.4

$$bM(a, b, z) - bM(a-1, b, z) - zM(a, b+1, z) = 0$$

13.4.5

$$b(a+z)M(a, b, z) + z(a-b)M(a, b+1, z)$$

$$- abM(a+1, b, z) = 0$$

**13.4.6**

$$(a-1+z)M(a, b, z) + (b-a)M(a-1, b, z) \\ + (1-b)M(a, b-1, z) = 0$$

**13.4.7**

$$b(1-b+z)M(a, b, z) + b(b-1)M(a-1, b-1, z) \\ - azM(a+1, b+1, z) = 0$$

$$13.4.8 \quad M'(a, b, z) = \frac{a}{b} M(a+1, b+1, z)$$

$$13.4.9 \quad \frac{d^n}{dz^n} \{M(a, b, z)\} = \frac{(a)_n}{(b)_n} M(a+n, b+n, z)$$

$$13.4.10 \quad aM(a+1, b, z) = aM(a, b, z) + zM'(a, b, z)$$

**13.4.11**

$$(b-a)M(a-1, b, z) = (b-a-z)M(a, b, z) \\ + zM'(a, b, z)$$

**13.4.12**

$$(b-a)M(a, b+1, z) = bM(a, b, z) - bM'(a, b, z)$$

**13.4.13**

$$(b-1)M(a, b-1, z) = (b-1)M(a, b, z) \\ + zM'(a, b, z)$$

**13.4.14**

$$(b-1)M(a-1, b-1, z) = (b-1-z)M(a, b, z) \\ + zM'(a, b, z)$$

**13.4.15**

$$U(a-1, b, z) + (b-2a-z)U(a, b, z) \\ + a(1+a-b)U(a+1, b, z) = 0$$

**13.4.16**

$$(b-a-1)U(a, b-1, z) + (1-b-z)U(a, b, z) \\ + zU(a, b+1, z) = 0$$

**13.4.17**

$$U(a, b, z) - aU(a+1, b, z) - U(a, b-1, z) = 0$$

**13.4.18**

$$(b-a)U(a, b, z) + U(a-1, b, z) \\ - zU(a, b+1, z) = 0$$

**13.4.19**

$$(a+z)U(a, b, z) - zU(a, b+1, z) \\ + a(b-a-1)U(a+1, b, z) = 0$$

**13.4.20**

$$(a+z-1)U(a, b, z) - U(a-1, b, z) \\ + (1+a-b)U(a, b-1, z) = 0$$

$$13.4.21 \quad U'(a, b, z) = -aU(a+1, b+1, z)$$

**13.4.22**

$$\frac{d^n}{dz^n} \{U(a, b, z)\} = (-1)^n (a)_n U(a+n, b+n, z)$$

**13.4.23**

$$a(1+a-b)U(a+1, b, z) = aU(a, b, z) \\ + zU'(a, b, z)$$

**13.4.24**

$$(1+a-b)U(a, b-1, z) = (1-b)U(a, b, z) \\ - zU'(a, b, z)$$

$$13.4.25 \quad U(a, b+1, z) = U(a, b, z) - U'(a, b, z)$$

**13.4.26**

$$U(a-1, b, z) = (a-b+z)U(a, b, z) - zU'(a, b, z)$$

**13.4.27**

$$U(a-1, b-1, z) = (1-b+z)U(a, b, z) \\ - zU'(a, b, z)$$

$$13.4.28 \quad 2\mu M_{\kappa-\frac{1}{2}, \mu-\frac{1}{2}}(z) - z^{\frac{1}{2}} M_{\kappa, \mu}(z) = 2\mu M_{\kappa+\frac{1}{2}, \mu-\frac{1}{2}}(z)$$

**13.4.29**

$$(1+2\mu+2\kappa)M_{\kappa+1, \mu}(z) - (1+2\mu-2\kappa)M_{\kappa-1, \mu}(z) \\ = 2(2\kappa-z)M_{\kappa, \mu}(z)$$

**13.4.30**

$$W_{\kappa+\frac{1}{2}, \mu}(z) - z^{\frac{1}{2}} W_{\kappa, \mu+\frac{1}{2}}(z) + (\kappa+\mu)W_{\kappa-\frac{1}{2}, \mu}(z) = 0$$

**13.4.31**

$$(2\kappa-z)W_{\kappa, \mu}(z) + W_{\kappa+1, \mu}(z) \\ = (\mu-\kappa+\frac{1}{2})(\mu+\kappa-\frac{1}{2})W_{\kappa-1, \mu}(z)$$

**13.4.32**

$$zM'_{\kappa, \mu}(z) = (\frac{1}{2}z-\kappa)M_{\kappa, \mu}(z) + (\frac{1}{2}+\mu+\kappa)M_{\kappa+1, \mu}(z)$$

$$13.4.33 \quad zW'_{\kappa, \mu}(z) = (\frac{1}{2}z-\kappa)W_{\kappa, \mu}(z) - W_{\kappa+1, \mu}(z)$$

### 13.5. Asymptotic Expansions and Limiting Forms

For  $|z|$  large,  $(a, b)$  fixed

13.5.1

$$\frac{M(a, b, z)}{\Gamma(b)} = \frac{e^{\pm i\pi a} z^{-a}}{\Gamma(b-a)} \left\{ \sum_{n=0}^{R-1} \frac{(a)_n (1+a-b)_n}{n!} (-z)^{-n} + O(|z|^{-R}) \right\} \\ + \frac{e^{\pm i\pi a} z^{-a}}{\Gamma(a)} \left\{ \sum_{n=0}^{S-1} \frac{(b-a)_n (1-a)_n}{n!} z^{-n} + O(|z|^{-S}) \right\}$$

the upper sign being taken if  $-\frac{1}{2}\pi < \arg z < \frac{3}{2}\pi$ , the lower sign if  $-\frac{3}{2}\pi < \arg z \leq -\frac{1}{2}\pi$ .

13.5.2

$$U(a, b, z) = z^{-a} \left\{ \sum_{n=0}^{R-1} \frac{(a)_n (1+a-b)_n}{n!} (-z)^{-n} + O(|z|^{-R}) \right\} \quad \left(-\frac{3}{2}\pi < \arg z < \frac{3}{2}\pi\right)$$

Converging Factors for the Remainders

13.5.3

$$O(|z|^{-R}) = \frac{(a)_R (1+a-b)_R}{R!} (-z)^{-R} \left[ \frac{1}{2} + \frac{(\frac{1}{2} + \frac{1}{2}b - \frac{1}{2}a + \frac{1}{2}z - \frac{1}{2}R)}{z} + O(|z|^{-1}) \right]$$

and

13.5.4

$$O(|z|^{-S}) = \frac{(b-a)_S (1-a)_S}{S!} z^{-S} \left[ \frac{3}{2} - b + 2a + z - S + O(|z|^{-1}) \right]$$

where the  $R$ 'th and  $S$ 'th terms are the smallest in the expansions 13.5.1 and 13.5.2.

For small  $s$  ( $a, b$  fixed)

13.5.5 As  $|z| \rightarrow 0$ ,  $M(a, b, 0) = 1$ ,  $b \neq -n$

$$13.5.6 \quad U(a, b, z) = \frac{\Gamma(b-1)}{\Gamma(a)} z^{1-b} + O(|z|^{\Re b-2}) \quad (\Re b \geq 2, b \neq 2)$$

$$13.5.7 \quad = \frac{\Gamma(b-1)}{\Gamma(a)} z^{1-b} + O(|\ln z|) \quad (b=2)$$

$$13.5.8 \quad = \frac{\Gamma(b-1)}{\Gamma(a)} z^{1-b} + O(1) \quad (1 < \Re b < 2)$$

$$*13.5.9 \quad = -\frac{1}{\Gamma(a)} [\ln z + \psi(a) + 2\gamma] + O(|z \ln z|) \quad (b=1)$$

$$13.5.10 \quad U(a, b, z) = \frac{\Gamma(1-b)}{\Gamma(1+a-b)} + O(|z|^{1-\Re b}) \quad (0 < \Re b < 1)$$

$$13.5.11 \quad = \frac{1}{\Gamma(1+a)} + O(|z \ln z|) \quad (b=0)$$

$$13.5.12 \quad = \frac{\Gamma(1-b)}{\Gamma(1+a-b)} + O(|z|) \quad (\Re b \leq 0, b \neq 0)$$

For large  $a$  ( $b, s$  fixed)

13.5.13

$$M(a, b, z) = \Gamma(b) e^{i\pi(\frac{1}{2}bz - az)^{1-i\pi}} J_{b-1}(\sqrt{(2bz-4az)}) \left[ 1 + O(|\frac{1}{2}b - a|^{-\sigma}) \right]$$

where

$$|z| = \left| \frac{1}{2}b - a \right|^{\rho} \quad \text{and} \quad \sigma = \min(1-\rho, \frac{1}{2} - \frac{3}{2}\rho), \quad 0 \leq \rho < \frac{1}{2}$$

13.5.14

$$M(a, b, x) = \Gamma(b) e^{i\pi(\frac{1}{2}bx - ax)^{1-i\pi}} \pi^{-1} \cos(\sqrt{(2bx-4ax)} - \frac{1}{2}b\pi + \frac{1}{2}\pi) \left[ 1 + O(|\frac{1}{2}b - a|^{-\sigma}) \right]$$

as  $a \rightarrow -\infty$  for  $b$  bounded,  $x$  real.

13.5.15

$$U(a, b, z) = \Gamma(\frac{1}{2}b - a + \frac{1}{2}) e^{i\pi z^{1-i\pi}} [\cos(a\pi) J_{b-1}(\sqrt{(2bz-4az)}) - \sin(a\pi) Y_{b-1}(\sqrt{(2bz-4az)})] \left[ 1 + O(|\frac{1}{2}b - a|^{-\sigma}) \right]$$

where  $\sigma$  is defined in 13.5.13.

13.5.16

$$U(a, b, x) = \Gamma(\frac{1}{2}b - a + \frac{1}{2}) \pi^{-1} e^{i\pi x^{1-i\pi}} \cos(\sqrt{(2bx-4ax)} - \frac{1}{2}b\pi + a\pi + \frac{1}{2}\pi) \left[ 1 + O(|\frac{1}{2}b - a|^{-\sigma}) \right]$$

as  $a \rightarrow -\infty$  for  $b$  bounded,  $x$  real.

For large real  $a, b, s$

If  $\cosh^2 \theta = x/(2b-4a)$  so that  $x > 2b-a > 1$ ,

13.5.17

$$M(a, b, x) = \Gamma(b) \sin(a\pi) \exp[(b-2a)(\frac{1}{2} \sinh 2\theta - \theta + \cosh^2 \theta)] \left[ (b-2a) \cosh \theta \right]^{1-\sigma} [\pi(\frac{1}{2}b-a) \sinh 2\theta]^{-1} \left[ 1 + O(|\frac{1}{2}b - a|^{-1}) \right]$$

13.5.18

$$U(a, b, x) = \exp[(b-2a)(\frac{1}{2} \sinh 2\theta - \theta + \cosh^2 \theta)] \left[ (b-2a) \cosh \theta \right]^{1-\sigma} [(\frac{1}{2}b-a) \sinh 2\theta]^{-1} \left[ 1 + O(|\frac{1}{2}b - a|^{-1}) \right]$$

If  $x = (2b - 4a)[1 + t/(b - 2a)^{1/2}]$ , so that

$$x \sim 2b - 4a$$

13.5.19

$$M(a, b, x) = e^{ix}(b - 2a)^{1-b} \Gamma(b) [\text{Ai}(t) \cos(a\pi) + \text{Bi}(t) \sin(a\pi) + O(|\frac{1}{2}b - a|^{-1})]$$

13.5.20

$$U(a, b, x) = e^{ix+a-i\pi} \Gamma(\frac{1}{2}) \pi^{-1} x^{\frac{1}{2}-a} \{1 - i\Gamma(\frac{5}{8})(bx - 2ax)^{-1/2} \pi^{-1} + O(|\frac{1}{2}b - a|^{-1})\}$$

If  $\cos^2 \theta = x/(2b - 4a)$  so that  $2b - 4a > x > 0$ ,

13.5.21

$$M(a, b, x) = \Gamma(b) \exp \{ (b - 2a) \cos^2 \theta \} [(b - 2a) \cos \theta]^{1-b} [\pi(\frac{1}{2}b - a) \sin 2\theta]^{-1/2} [\sin(a\pi) + \sin \{ (\frac{1}{2}b - a)(2\theta - \sin 2\theta) + \frac{1}{2}\pi \}] + O(|\frac{1}{2}b - a|^{-1})]$$

13.5.22

$$U(a, b, x) = \exp [(b - 2a) \cos^2 \theta] [(b - 2a) \cos \theta]^{1-b} [(\frac{1}{2}b - a) \sin 2\theta]^{-1/2} \{ \sin [(\frac{1}{2}b - a)(2\theta - \sin 2\theta) + \frac{1}{2}\pi] + O(|\frac{1}{2}b - a|^{-1}) \}$$

13.6. Special Cases

|         | $M(a, b, z)$                   |               |                  | Relation  | Function                 |
|---------|--------------------------------|---------------|------------------|---|--------------------------|
|         | $a$                            | $b$           | $z$              |   |                          |
| 13.6.1  | $\nu + \frac{1}{2}$            | $2\nu + 1$    | $2iz$            | $\Gamma(1 + \nu) e^{iz} (\frac{1}{2}z)^{-\nu} J_{\nu}(z)$   | Bessel                   |
| 13.6.2  | $-\nu + \frac{1}{2}$           | $-2\nu + 1$   | $2iz$            | $\Gamma(1 - \nu) e^{iz} (\frac{1}{2}z)^{\nu} [\cos(\nu\pi) J_{\nu}(z) - \sin(\nu\pi) Y_{\nu}(z)]$ | Bessel                   |
| 13.6.3  | $\nu + \frac{1}{2}$            | $2\nu + 1$    | $2z$             | $\Gamma(1 + \nu) e^{iz} (\frac{1}{2}z)^{-\nu} I_{\nu}(z)$   | Modified Bessel          |
| 13.6.4  | $n + 1$                        | $2n + 2$      | $2iz$            | $\Gamma(\frac{3}{2} + n) e^{iz} (\frac{1}{2}z)^{-n-1/2} J_{n+1/2}(z)$                             | Spherical Bessel         |
| 13.6.5  | $-n$                           | $-2n$         | $2iz$            | $\Gamma(\frac{1}{2} - n) e^{iz} (\frac{1}{2}z)^{n+1/2} J_{-n-1/2}(z)$                             | Spherical Bessel         |
| 13.6.6  | $n + 1$                        | $2n + 2$      | $2z$             | $\Gamma(\frac{3}{2} + n) e^{iz} (\frac{1}{2}z)^{-n-1/2} I_{n+1/2}(z)$ *                           | Spherical Bessel         |
| 13.6.7  | $n + \frac{1}{2}$              | $2n + 1$      | $-2\sqrt{ix}$    | $\Gamma(1 + n) e^{-ix} (\frac{1}{2}ix)^{-n} (\text{ber}_n x + i \text{bei}_n x)$                  | Kelvin                   |
| 13.6.8  | $L + 1 - i\eta$                | $2L + 2$      | $2ix$            | $e^{ix} F_L(\eta, x) x^{-L-1} / C_L(\eta)$  | Coulomb Wave             |
| 13.6.9  | $-n$                           | $\alpha + 1$  | $x$              | $\frac{n!}{(\alpha + 1)_n} L_n^{(\alpha)}(x)$   | Laguerre                 |
| 13.6.10 | $a$                            | $a + 1$       | $-x$             | $ax^{-a} \gamma(a, x)$  | Incomplete Gamma         |
| 13.6.11 | $-n$                           | $1 + \nu - n$ | $x$              | $\frac{(n!)^{\frac{1}{2}} x^{\frac{1}{2}n}}{(1 + \nu - n)_n} \rho_n(\nu, x)$                      | Poisson-Charlier         |
| 13.6.12 | $a$                            | $a$           | $z$              | $e^z$   | Exponential              |
| 13.6.13 | 1                              | 2             | $-2iz$           | $\frac{e^{-iz}}{z} \sin z$  | Trigonometric            |
| 13.6.14 | 1                              | 2             | $2z$             | $\frac{e^z}{z} \sinh z$   | Hyperbolic               |
| 13.6.15 | $-\frac{1}{2}\nu$              | $\frac{1}{2}$ | $\frac{1}{2}z^2$ | $2^{-1/2} \exp(\frac{1}{2}z^2) E_{\nu}^{(0)}(z)$  | Weber                    |
| 13.6.16 | $\frac{1}{2} - \frac{1}{2}\nu$ | $\frac{1}{2}$ | $\frac{1}{2}z^2$ | $\frac{\exp(\frac{1}{2}z^2)}{2z} E_{\nu}^{(1)}(z)$  | or<br>Parabolic Cylinder |
| 13.6.17 | $-n$                           | $\frac{1}{2}$ | $\frac{1}{2}z^2$ | $\frac{n!}{(2n)!} (-\frac{1}{2})^{-n} He_n(x)$  | Hermite                  |
| 13.6.18 | $-n$                           | $\frac{1}{2}$ | $\frac{1}{2}z^2$ | $\frac{n!}{(2n+1)!} (-\frac{1}{2})^{-n} \frac{1}{x} He_{2n+1}(x)$ *                               | Hermite                  |
| 13.6.19 | $\frac{1}{2}$                  | $\frac{1}{2}$ | $-x^2$           | $\frac{\pi^{1/2}}{2x} \text{erf } x$  | Error Integral           |
| 13.6.20 | $\frac{1}{2}m + \frac{1}{2}$   | $1 + n$       | $r^2$            | $\frac{n! r^{-2n+m-1}}{\Gamma(\frac{1}{2}m + \frac{1}{2})} e^{r^2} T(m, n, r)$ *                  | Toronto                  |

\*See page II.

13.6. Special Cases—Continued

|         | $U(a, b, z)$                    |               |                       | Relation  | Function                          |
|---------|---------------------------------|---------------|-----------------------|---|-----------------------------------|
|         | $a$                             | $b$           | $z$                   |   |                                   |
| 13.6.21 | $\nu + \frac{1}{2}$             | $2\nu + 1$    | $2z$                  | $\pi^{-\frac{1}{2}} e^z (2z)^{-\nu} K_\nu(z)$   | Modified Bessel                   |
| 13.6.22 | $\nu + \frac{1}{2}$             | $2\nu + 1$    | $-2iz$                | $\frac{1}{2} \pi^{\frac{1}{2}} e^{i[\pi(\nu + \frac{1}{2}) - z]} (2z)^{-\nu} H_\nu^{(1)}(z)^*$  | Hankel                            |
| 13.6.23 | $\nu + \frac{1}{2}$             | $2\nu + 1$    | $2iz$                 | $\frac{1}{2} \pi^{\frac{1}{2}} e^{-i[\pi(\nu + \frac{1}{2}) - z]} (2z)^{-\nu} H_\nu^{(2)}(z)^*$ | Hankel                            |
| 13.6.24 | $n + 1$                         | $2n + 2$      | $2z$                  | $\pi^{-\frac{1}{2}} e^z (2z)^{-n-1} K_{n+\frac{1}{2}}(z)$                                       | Spherical Bessel                  |
| 13.6.25 | $\frac{2}{3}$                   | $\frac{2}{3}$ | $\frac{2}{3} z^{3/2}$ | $\pi^{\frac{1}{2}} z^{-1} \exp(\frac{2}{3} z^{3/2}) 2^{-2/3} 3^{5/6} \text{Ai}(z)$              | Airy                              |
| 13.6.26 | $n + \frac{1}{2}$               | $2n + 1$      | $\sqrt{ix}$           | $i^n \pi^{-\frac{1}{2}} e^{\sqrt{ix}} (2\sqrt{ix})^{-n} [\text{ker}_n x + i \text{kei}_n x]$    | Kelvin                            |
| 13.6.27 | $-n$                            | $\alpha + 1$  | $x$                   | $(-1)^n n! L_n^{(\alpha)}(x)$   | Laguerre                          |
| 13.6.28 | $1 - a$                         | $1 - a$       | $x$                   | $e^x \Gamma(a, x)$  | Incomplete Gamma                  |
| 13.6.29 | 1                               | 1             | $-x$                  | $-e^{-x} \text{Ei}(x)$  | Exponential Integral              |
| 13.6.30 | 1                               | 1             | $x$                   | $e^x E_1(x)$  | Exponential Integral              |
| 13.6.31 | 1                               | 1             | $-\ln x^*$            | $-\frac{1}{x} \text{li}(x)$   | Logarithmic Integral              |
| 13.6.32 | $\frac{1}{2} m - n$             | $1 + m$       | $x$                   | $\Gamma(1 + n - \frac{1}{2} m) e^{-x} x^{-(\frac{1}{2} m - n)} \omega_{n, m}(x)$                | Cunningham                        |
| 13.6.33 | $-\frac{1}{2} \nu$              | 0             | $2x$                  | $\Gamma(1 + \frac{1}{2} \nu) e^{2x} k_\nu(x)$ for $x > 0$                                       | Bateman                           |
| 13.6.34 | 1                               | 1             | $ix$                  | $e^{ix} [-\frac{1}{2} \pi i + i \text{Si}(x) - \text{Ci}(x)]$                                   | Sine and Cosine Integral          |
| 13.6.35 | 1                               | 1             | $-ix$                 | $e^{-ix} [\frac{1}{2} \pi i - i \text{Si}(x) - \text{Ci}(x)]$                                   | Sine and Cosine Integral          |
| 13.6.36 | $-\frac{1}{2} \nu$              | $\frac{1}{2}$ | $\frac{1}{2} z^2$     | $2^{-\frac{1}{2}} e^{z^2/4} D_\nu(z)$   | Weber<br>or<br>Parabolic Cylinder |
| 13.6.37 | $\frac{1}{2} - \frac{1}{2} \nu$ | $\frac{1}{2}$ | $\frac{1}{2} z^2$     | $2^{\frac{1}{2}} e^{z^2/4} D_\nu(z)/z^*$  |                                   |
| 13.6.38 | $\frac{1}{2} - \frac{1}{2} n$   | $\frac{1}{2}$ | $x^2$                 | $2^{-n} H_n(x)/x^*$   | Hermite                           |
| 13.6.39 | $\frac{1}{2}$                   | $\frac{1}{2}$ | $x^2$                 | $\sqrt{\pi} \exp(x^2) \text{erfc } x$   | Error Integral                    |

13.7. Zeros and Turning Values

If  $j_{b-1, r}$  is the  $r$ 'th positive zero of  $J_{b-1}(x)$ , then a first approximation  $X_0$  to the  $r$ 'th positive zero of  $M(a, b, x)$  is

13.7.1  $X_0 = j_{b-1, r}^2 \{ 1/(2b-4a) + O(1/(\frac{1}{2}b-a)^2) \}$

13.7.2  $X_0 \approx \frac{\pi^2(r + \frac{1}{2}b - \frac{3}{4})^2}{2b-4a}$

A closer approximation is given by

13.7.3  $X_1 = X_0 - M(a, b, X_0)/M'(a, b, X_0)$

For the derivative,

13.7.4

$M'(a, b, X_1) = M'(a, b, X_0) \{ 1 + (b - X_0) \frac{M(a, b, X_0)}{M'(a, b, X_0)} \}$

If  $X'_0$  is the first approximation to a turning value of  $M(a, b, x)$ , that is, to a zero of  $M'(a, b, x)$  then a better approximation is

13.7.5  $X'_1 = X'_0 - \frac{X'_0 M'(a, b, X'_0)}{a M(a, b, X'_0)}$

\*See page II.

The self-adjoint equation 13.1.1 can also be written

$$13.7.6 \quad \frac{d}{dz}[z^b e^{-z} \frac{dw}{dz}] = az^{b-1} e^{-z} w$$

**The Sonine-Polya Theorem**

The maxima and minima of  $|w|$  form an increasing or decreasing sequence according as

$$-ax^{2b-1} e^{-2x}$$

is an increasing or decreasing function of  $x$ , that is, they form an increasing sequence for  $M(a, b, x)$  if  $a > 0, x < b - \frac{1}{2}$  or if  $a < 0, x > b - \frac{1}{2}$ , and a decreasing sequence if  $a > 0$  and  $x > b - \frac{1}{2}$  or if  $a < 0$  and  $x < b - \frac{1}{2}$ .

The turning values of  $|w|$  lie near the curves

**13.7.7**

$$w = \pm \Gamma(b) \pi^{-1/2} e^{x/2} (\frac{1}{2}bx - ax)^{\frac{1}{2}-b} \{1 - x/(2b-4a)\}^{-1/4}$$

**Numerical Methods**

**13.8. Use and Extension of the Tables**

Calculation of  $M(a, b, x)$

**Kummer's Transformation**

**Example 1.** Compute  $M(.3, .2, -.1)$  to 7S. Using 13.1.27 and Tables 4.4 and 13.1 we have  $a = .3, b = .2$  so that

$$M(.3, .2, -.1) = e^{-.1} M(-.1, .2, .1) = .85784 \ 90.$$

Thus 13.1.27 can be used to extend Table 13.1 to negative values of  $x$ . Kummer's transformation should also be used when  $a$  and  $b$  are large and nearly equal, for  $x$  large or small.

**Example 2.** Compute  $M(17, 16, 1)$  to 7S. Here  $a = 17, b = 16$ , and

$$M(17, 16, 1) = e^1 M(-1, 16, -1) = 2.71828 \ 18 \times 1.06250 \ 00 = 2.88817 \ 44.$$

**Recurrence Relations**

**Example 3.** Compute  $M(-1.3, 1.2, .1)$  to 7S. Using 13.4.1 and Table 13.1 we have  $a = -.3, b = .2$  so that

$$M(-1.3, .2, .1) = 2[.7 M(-.3, .2, .1) - .3 M(.7, .2, .1)] = .35821 \ 23.$$

By 13.4.5 when  $a = -1.3$  and  $b = .2$ ,

$$M(-1.3, 1.2, .1) = [.26 M(-.3, .2, .1) - .24 M(-1.3, .2, .1)] / .15 = .89241 \ 08.$$

Similarly when  $a = -.3$  and  $b = .2$

$$M(-.3, 1.2, .1) = .97459 \ 52.$$

Check, by 13.4.6,

$$M(-1.3, 1.2, .1) = [.2 M(-.3, .2, .1) + 1.2 M(-.3, 1.2, .1)] / 1.5 = .89241 \ 08.$$

In this way 13.4.1-13.4.7 can be used together with 13.1.27 to extend Table 13.1 to the range

$$-10 \leq a \leq 10, -10 \leq b \leq 10, -10 \leq x \leq 10.$$

This extension of ten units in any direction is possible with the loss of about 1S. All the recurrence relations are stable except i) if  $a < 0, b < 0$  and  $|a| > |b|, x > 0$ , or ii)  $b < a, b < 0, |b-a| > |b|, x < 0$ , when the oscillations may become large, especially if  $|x|$  also is large.

Neither interpolation nor the use of recurrence relations should be attempted in the strips  $b = -n \pm .1$  where the function is very large numerically. In particular  $M(a, b, x)$  cannot be evaluated in the neighborhood of the points  $a = -m, b = -n, m \leq n$ , as near these points small changes in  $a, b$  or  $x$  can produce very large changes in the numerical value of  $M(a, b, x)$ .

**Example 4.** At the point  $(-1, -1, x), M(a, b, x)$  is undefined.

When  $a = -1, M(-1, b, x) = 1 - \frac{x}{b}$  for all  $x$ .

Hence  $\lim_{b \rightarrow -1} M(-1, b, x) = 1 + x$ . But  $M(b, b, x) = e^x$  for all  $x$ , when  $a = b$ . Hence  $\lim_{b \rightarrow -1} M(b, b, x) = e^x$ .

In the first case  $b \rightarrow -1$  along the line  $a = -1$ , and in the second case  $b \rightarrow -1$  along the line  $a = b$ .

**Derivatives**

**Example 5.** To evaluate  $M'(-.7, -.6, .5)$  to 7S. By 13.4.8, when  $a = -.7$  and  $b = -.6$ , we have

$$M'(-.7, -.6, .5) = \frac{-.7}{-.6} M(.3, .4, .5) = 1.724128.$$

**Asymptotic Formulas**

For  $x \geq 10, a$  and  $b$  small,  $M(a, b, x)$  should be evaluated by 13.5.1 using converging factors 13.5.3 and 13.5.4 to improve the accuracy if necessary.



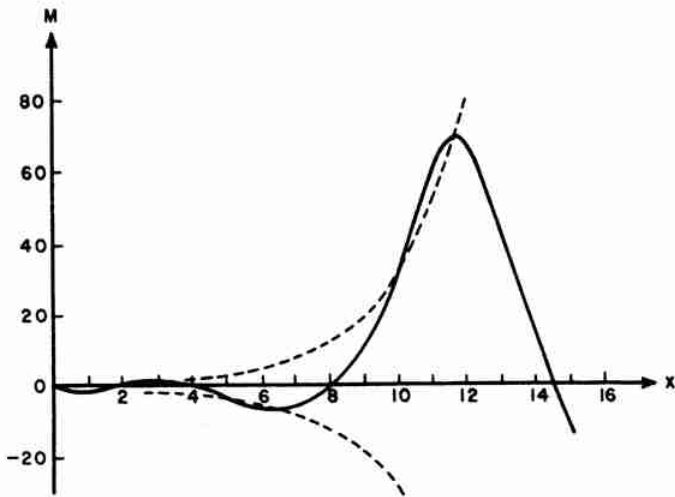

FIGURE 13.2.  $M(-4.5, 1, x)$ .

(From F. G. Tricomi, *Funzioni ipergeometriche confluenti*, Edizioni Cremonese, Rome, Italy, 1954, with permission.)

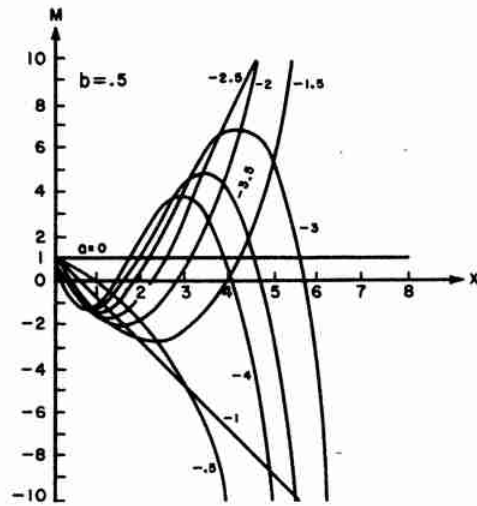
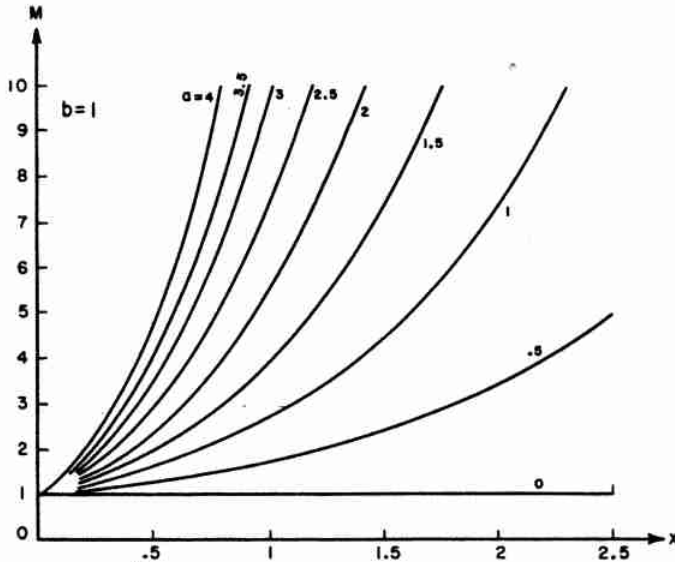
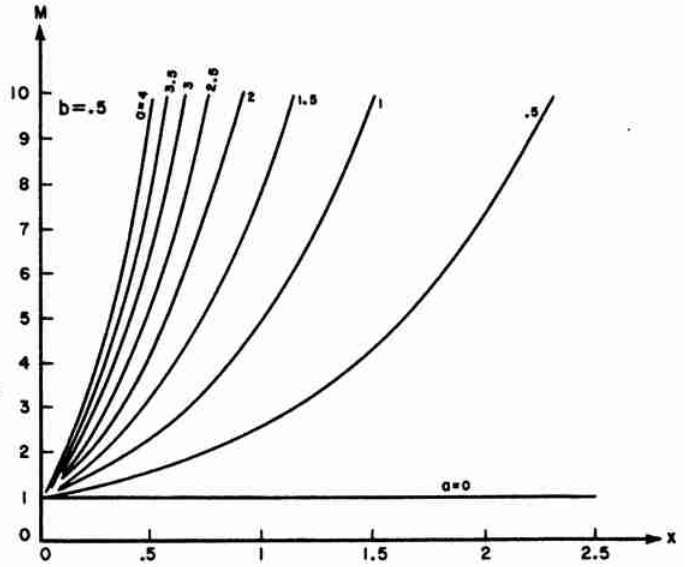

FIGURE 13.4.  $M(a, .5, x)$ .

(From E. Jahnke and F. Emde, *Tables of functions*, Dover Publications, Inc., New York, N.Y., 1945, with permission.)

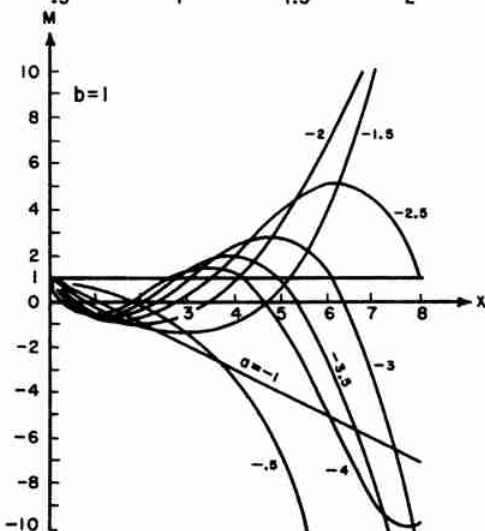

FIGURE 13.3.  $M(a, 1, x)$ .

(From E. Jahnke and F. Emde, *Tables of functions*, Dover Publications, Inc., New York, N.Y., 1945, with permission.)

References

Texts

- [13.1] H. Buchholz, *Die konfluente hypergeometrische Funktion* (Springer-Verlag, Berlin, Germany, 1953). On Whittaker functions, with a large bibliography.
- [13.2] A. Erdélyi et al., *Higher transcendental functions*, vol. 1, ch. 6 (McGraw-Hill Book Co., Inc., New York, N.Y., 1953). On Kummer functions.
- [13.3] H. Jeffreys and B. S. Jeffreys, *Methods of mathematical physics*, ch. 23 (Cambridge Univ. Press, Cambridge, England, 1950). On Kummer functions.
- [13.4] J. C. P. Miller, Note on the general solutions of the confluent hypergeometric equation, *Math. Tables Aids Comp.* **9**, 97-99 (1957).
- [13.5] L. J. Slater, On the evaluation of the confluent hypergeometric function, *Proc. Cambridge Philos. Soc.* **49**, 612-622 (1953).

- [13.6] L. J. Slater, The evaluation of the basic confluent hypergeometric function, Proc. Cambridge Philos. Soc. **50**, 404-413 (1954).
- [13.7] L. J. Slater, The real zeros of the confluent hypergeometric function, Proc. Cambridge Philos. Soc. **52**, 626-635 (1956).
- [13.8] C. A. Swanson and A. Erdélyi, Asymptotic forms of confluent hypergeometric functions, Memoir 25, Amer. Math. Soc. (1957).
- [13.9] F. G. Tricomi, Funzioni ipergeometriche confluenti (Edizioni Cremonese, Rome, Italy, 1954). On Kummer functions.
- [13.10] E. T. Whittaker and G. N. Watson, A course of modern analysis, ch. 16, 4th ed. (Cambridge Univ. Press, Cambridge, England, 1952). On Whittaker functions.
- [13.11] J. R. Airey, The confluent hypergeometric function, British Association Reports, Oxford, 276-294 (1926), and Leeds, 220-244 (1927).  $M(a, b, x)$ ,  $a = -4(.5)4$ ,  $b = \frac{1}{2}, 1, \frac{3}{2}, 2, 3, 4$ ,  $x = .1(.1)2(.2)3(.5)8$ , 5D.
- [13.12] J. R. Airey and H. A. Webb, The practical importance of the confluent hypergeometric function, Phil. Mag. **36**, 129-141 (1918).  $M(a, b, x)$ ,  $a = -3(.5)4$ ,  $b = 1(1)7$ ,  $x = 1(1)6(2)10$ , 4S.
- [13.13] E. Jahnke and F. Emde, Tables of functions, ch. 10, 4th ed. (Dover Publications, Inc., New York, N.Y., 1945). Graphs of  $M(a, b, x)$  based on the tables of [13.11].
- [13.14] P. Nath, Confluent hypergeometric functions, Sankhya J. Indian Statist. Soc. **11**, 153-166 (1951).  $M(a, b, x)$ ,  $a = 1(1)40$ ,  $b = 3$ ,  $x = .02(.02).1(.1)1(1)10(10)50$ , 100, 200, 6D.
- [13.15] S. Rushton and E. D. Lang, Tables of the confluent hypergeometric function, Sankhya J. Indian Statist. Soc. **13**, 369-411 (1954).  $M(a, b, x)$ ,  $a = .5(.5)40$ ,  $b = .5(.5)3.5$ ,  $x = .02(.02).1(.1)1(1)10(10)50$ , 100, 200, 7S.
- [13.16] L. J. Slater, Confluent hypergeometric functions (Cambridge Univ. Press, Cambridge, England, 1960).  $M(a, b, x)$ ,  $a = -1(.1)1$ ,  $b = .1(.1)1$ ,  $x = .1(.1)10$ , 8S;  $M(a, b, 1)$ ,  $a = -11(.2)2$ ,  $b = -4(.2)1$ , 8S; and smallest positive values of  $x$  for which  $M(a, b, x) = 0$ ,  $a = -4(.1) - .1$ ,  $b = .1(.1)2.5$ , 8S.

### Tables



# 14. Coulomb Wave Functions

MILTON ABRAMOWITZ <sup>1</sup>

## Contents

|   | Page |
|---|------|
| <b>Mathematical Properties</b> . . . . .  | 538  |
| 14.1. Differential Equation, Series Expansions . . . . .  | 538  |
| 14.2. Recurrence and Wronskian Relations . . . . .  | 539  |
| 14.3. Integral Representations . . . . .  | 539  |
| 14.4. Bessel Function Expansions . . . . .  | 539  |
| 14.5. Asymptotic Expansions . . . . .   | 540  |
| 14.6. Special Values and Asymptotic Behavior . . . . .  | 542  |
| <b>Numerical Methods</b> . . . . .  | 543  |
| 14.7. Use and Extension of the Tables . . . . .   | 543  |
| <b>References</b> . . . . .   | 544  |
| <b>Table 14.1. Coulomb Wave Functions of Order Zero</b> ( $.5 \leq \eta \leq 20$ ,<br>$1 \leq \rho \leq 20$ ) . . . . . | 546  |
| $F_0(\eta, \rho), \quad \frac{d}{d\rho} F_0(\eta, \rho), \quad G_0(\eta, \rho), \quad \frac{d}{d\rho} G_0(\eta, \rho)$  |      |
| $\eta = .5(.5)20, \quad \rho = 1(1)20, \quad 5S$  |      |
| <b>Table 14.2. <math>C_0(\eta) = e^{-i\pi\eta}  \Gamma(1+i\eta) </math></b> . . . . .                                   | 554  |
| $\eta = 0(.05)3, \quad 6S$  |      |

The author wishes to acknowledge the assistance of David S. Liepman in checking the formulas and tables.

---

<sup>1</sup> National Bureau of Standards (deceased).

# 14. Coulomb Wave Functions

## Mathematical Properties

### 14.1. Differential Equation, Series Expansions

#### Differential Equation

#### 14.1.1

$$\frac{d^2 w}{d\rho^2} + \left[1 - \frac{2\eta}{\rho} - \frac{L(L+1)}{\rho^2}\right] w = 0$$

( $\rho > 0$ ,  $-\infty < \eta < \infty$ ,  $L$  a non-negative integer)

The Coulomb wave equation has a regular singularity at  $\rho=0$  with indices  $L+1$  and  $-L$ ; it has an irregular singularity at  $\rho=\infty$ .

#### General Solution

#### 14.1.2

$$w = C_1 F_L(\eta, \rho) + C_2 G_L(\eta, \rho) \quad (C_1, C_2 \text{ constants})$$

where  $F_L(\eta, \rho)$  is the regular Coulomb wave function and  $G_L(\eta, \rho)$  is the irregular (logarithmic) Coulomb wave function.

#### Regular Coulomb Wave Function $F_L(\eta, \rho)$

#### 14.1.3

$$F_L(\eta, \rho) = C_L(\eta) \rho^{L+1} e^{-i\rho} M(L+1-i\eta, 2L+2, 2i\rho)$$

#### 14.1.4

$$= C_L(\eta) \rho^{L+1} \Phi_L(\eta, \rho)$$

#### 14.1.5

$$\Phi_L(\eta, \rho) = \sum_{k=L+1}^{\infty} A_k^L(\eta) \rho^{k-L-1}$$

#### 14.1.6

$$A_{L+1}^L = 1, \quad A_{L+2}^L = \frac{\eta}{L+1},$$

$$(k+L)(k-L-1)A_k^L = 2\eta A_{k-1}^L - A_{k-2}^L \quad (k > L+2)$$

$$14.1.7 \quad C_L(\eta) = \frac{2^L e^{-\frac{\pi\eta}{2}} |\Gamma(L+1+i\eta)|}{\Gamma(2L+2)}$$

(See chapter 6.)

#### 14.1.8

$$C_0^2(\eta) = 2\pi\eta(e^{2\pi\eta} - 1)^{-1}$$

#### 14.1.9

$$C_L^2(\eta) = \frac{p_L(\eta) C_0^2(\eta)}{2\eta(2L+1)}$$

#### 14.1.10

$$C_L(\eta) = \frac{(L^2 + \eta^2)^{\frac{1}{2}}}{L(2L+1)} C_{L-1}(\eta)$$

#### 14.1.11

$$\frac{p_L(\eta)}{2\eta} = \frac{(1+\eta^2)(4+\eta^2) \dots (L^2+\eta^2) 2^{2L}}{(2L+1)[(2L)!]^2}$$

$$14.1.12 \quad F_L' = \frac{d}{d\rho} F_L(\eta, \rho) = C_L(\eta) \rho^L \Phi_L^*(\eta, \rho)$$

$$14.1.13 \quad \Phi_L^*(\eta, \rho) = \sum_{k=L+1}^{\infty} k A_k^L(\eta) \rho^{k-L-1}$$

#### Irregular Coulomb Wave Function $G_L(\eta, \rho)$

#### 14.1.14

$$G_L(\eta, \rho) = \frac{2\eta}{C_0^2(\eta)} F_L(\eta, \rho) [\ln 2\rho + \frac{q_L(\eta)}{p_L(\eta)}] + \theta_L(\eta, \rho)$$

#### 14.1.15

$$\theta_L(\eta, \rho) = D_L(\eta) \rho^{-L} \psi_L(\eta, \rho)$$

#### 14.1.16

$$D_L(\eta) C_L(\eta) = \frac{1}{2L+1}$$

#### 14.1.17

$$\psi_L(\eta, \rho) = \sum_{k=-L}^{\infty} a_k^L(\eta) \rho^{k+L}$$

#### 14.1.18

$$a_{-L}^L = 1, \quad a_{L+1}^L = 0,$$

$$(k-L-1)(k+L)a_k^L = 2\eta a_{k-1}^L - a_{k-2}^L - (2k-1)p_L(\eta)A_k^L$$

#### 14.1.19

$$\frac{q_L(\eta)}{p_L(\eta)} = \sum_{s=1}^L \frac{s}{s^2 + \eta^2} - \sum_{s=1}^{2L+1} \frac{1}{s}$$

$$+ \mathcal{O}\left\{\frac{\Gamma'(1+i\eta)}{\Gamma(1+i\eta)}\right\} + 2\gamma + \frac{r_L(\eta)}{p_L(\eta)}$$

(See Table 6.8.)

#### 14.1.20

$$r_L(\eta) = \frac{(-1)^{L+1}}{(2L)!} \mathcal{S}\left\{\frac{1}{2L+1} + \frac{2(i\eta-L)}{2L(1!)}\right.$$

$$+ \frac{2^2(i\eta-L)(i\eta-L+1)}{(2L-1)(2!)} + \dots$$

$$\left. + \frac{2^{2L}(i\eta-L)(i\eta-L+1) \dots (i\eta+L-1)}{(2L)!}\right\}$$

#### 14.1.21

$$G_L' = \frac{dG_L}{d\rho} = \frac{2\eta}{C_0^2(\eta)} \left\{ F_L' [\ln 2\rho + \frac{q_L(\eta)}{p_L(\eta)}] + \rho^{-1} F_L(\eta, \rho) \right\}$$

$$+ \theta_L'(\eta, \rho)$$

14.1.22  $\theta'_L = \frac{d}{d\rho} \theta_L(\eta, \rho) = D_L(\eta) \rho^{-L-1} \psi_L^*(\eta, \rho)$

14.1.23  $\psi_L^*(\eta, \rho) = \sum_{k=-L}^{\infty} k a_k^L(\eta) \rho^{k+L}$

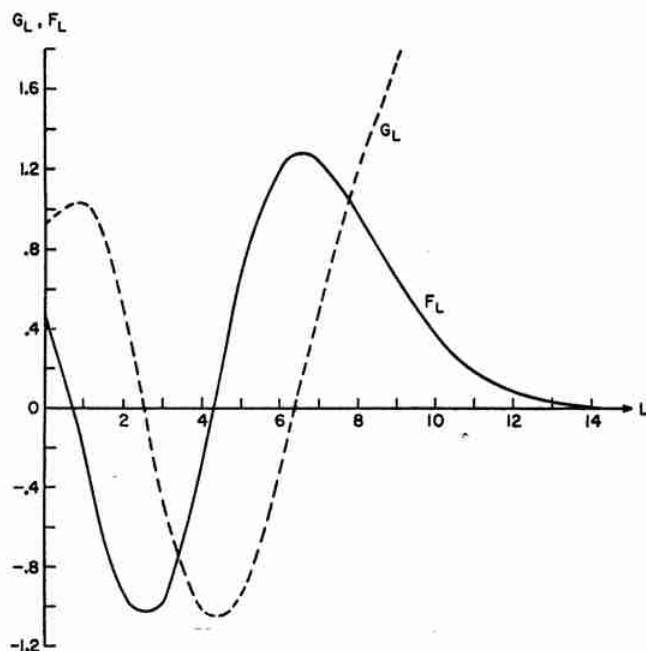

FIGURE 14.1.  $F_L(\eta, \rho), G_L(\eta, \rho)$ .  
 $\eta=1, \rho=10$

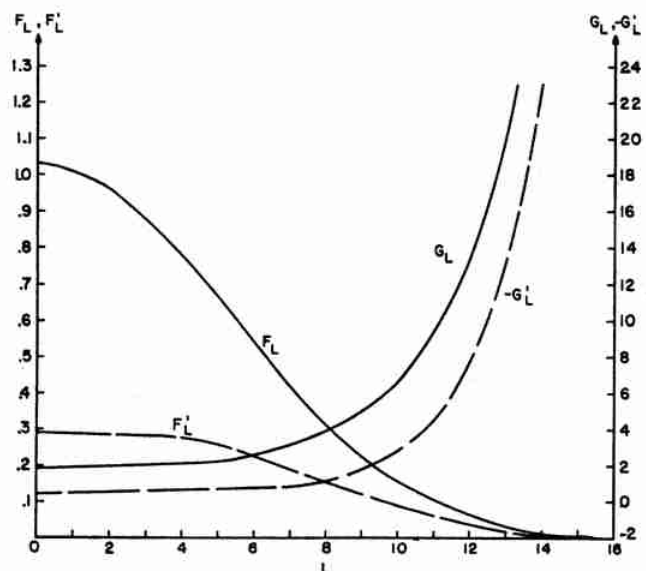

FIGURE 14.2.  $F_L, F'_L, G_L$  and  $G'_L$ .  
 $\eta=10, \rho=20$

## 14.2. Recurrence and Wronskian Relations

### Recurrence Relations

If  $u_L = F_L(\eta, \rho)$  or  $G_L(\eta, \rho)$ ,

14.2.1  $L \frac{du_L}{d\rho} = (L^2 + \eta^2)^{1/2} u_{L-1} - \left(\frac{L^2}{\rho} + \eta\right) u_L$

14.2.2  $(L+1) \frac{du_L}{d\rho} = \left[\frac{(L+1)^2}{\rho} + \eta\right] u_L - [(L+1)^2 + \eta^2]^{1/2} u_{L+1}$

14.2.3  $L[(L+1)^2 + \eta^2]^{1/2} u_{L+1} = (2L+1) \left[\eta + \frac{L(L+1)}{\rho}\right] u_L - (L+1)[L^2 + \eta^2]^{1/2} u_{L-1}$

### Wronskian Relations

14.2.4  $F'_L G_L - F_L G'_L = 1$

14.2.5  $F_{L-1} G_L - F_L G_{L-1} = L(L^2 + \eta^2)^{-1/2}$

## 14.3. Integral Representations

14.3.1  $F_L + iG_L = \frac{ie^{-i\rho} \rho^{-L}}{(2L+1)! C_L(\eta)} \int_0^{\infty} e^{-tL - i\eta(t+2i\rho)^{L+1/2}} dt$

14.3.2  $F_L - iG_L = \frac{e^{-\pi\eta} \rho^{L+1}}{(2L+1)! C_L(\eta)} \int_{-1}^{-i\infty} e^{-t\rho t(1-t)^{L-1/2} (1+t)^{L+1/2}} dt$

14.3.3  $F_L + iG_L = \frac{e^{-\pi\eta} \rho^{L+1}}{(2L+1)! C_L(\eta)} \int_0^{\infty} \{ (1 - \tanh^2 t)^{L+1} \exp[-i(\rho \tanh t - 2\eta t)] + i(1+t^2)^L \exp[-\rho t + 2\eta \arctan t] \} dt$

## 14.4. Bessel Function Expansions

### Expansion in Terms of Bessel-Clifford Functions

14.4.1  $F_L(\eta, \rho) = C_L(\eta) \frac{(2L+1)!}{(2\eta)^{2L+1}} \rho^{-L} \sum_{k=2L+1}^{\infty} b_k t^{k/2} I_k(2\sqrt{t})$   
 $(t=2\eta\rho, \eta>0)$

14.4.2  $G_L(\eta, \rho) \sim D_L(\eta) \lambda_L(\eta) \rho^{-L} \sum_{k=2L+1}^{\infty} (-1)^k b_k t^{k/2} K_k(2\sqrt{t})$

## 14.4.3

$$b_{2L+1}=1, \quad b_{2L+2}=0,$$

$$* \quad 4\eta^2(k-2L)b_{k+1}+kb_{k-1}+b_{k-2}=0 \quad (k \geq 2L+2)$$

## 14.4.4

$$\lambda_L(\eta) \sum_{k=2L+1}^{\infty} (-1)^k (k-1)! b_k = 2$$

(See chapter 9.)

## Expansion in Terms of Spherical Bessel Functions

## 14.4.5

$$F_L(\eta, \rho) = 1 \cdot 3 \cdot 5 \dots (2L+1) \rho C_L(\eta) \sum_{k=L}^{\infty} b_k \sqrt{\frac{\pi}{2\rho}} J_{k+1/2}(\rho)$$

## 14.4.6

$$b_L=1, \quad b_{L+1} = \frac{2L+3}{L+1} \eta$$

$$b_k = \frac{(2k+1)}{k(k+1)-L(L+1)}$$

$$\left\{ 2\eta b_{k-1} - \frac{(k-1)(k-2)-L(L+1)}{2k-3} b_{k-2} \right\}$$

 $(k > L+1)$ 

## 14.4.7

$$F'_L(\eta, \rho) = 1 \cdot 3 \cdot 5 \dots (2L+1) \rho C'_L(\eta) \left\{ \frac{(L+1)}{(2L+1)} b_L \sqrt{\frac{\pi}{2\rho}} J_{L-1/2}(\rho) + \frac{(L+2)}{(2L+3)} b_{L+1} \sqrt{\frac{\pi}{2\rho}} J_{L+1/2}(\rho) + \sum_{k=L+1}^{\infty} b'_k \sqrt{\frac{\pi}{2\rho}} J_{k+1/2}(\rho) \right\}$$

$$14.4.8 \quad b'_k = \frac{(k+2)}{(2k+3)} b_{k+1} - \frac{(k-1)}{(2k-1)} b_{k-1}$$

## Expansion in Terms of Airy Functions

$$x = (2\eta - \rho)/(2\eta)^{1/3} \quad \mu = (2\eta)^{2/3}, \quad \eta \gg 0$$

$$|\rho - 2\eta| < 2\eta$$

## 14.4.9

$$F_0(\eta, \rho) = \pi^{1/2} (2\eta)^{1/3} \left\{ \frac{\text{Ai}(x)}{\text{Bi}(x)} \left[ 1 + \frac{g_1}{\mu} + \frac{g_2}{\mu^2} + \dots \right] + \frac{\text{Ai}'(x)}{\text{Bi}'(x)} \left[ \frac{f_1}{\mu} + \frac{f_2}{\mu^2} + \dots \right] \right\}$$

## 14.4.10

$$F'_0(\eta, \rho) = -\pi^{1/2} (2\eta)^{-1/3} \left\{ \frac{\text{Ai}(x)}{\text{Bi}(x)} \left[ \frac{g'_1 + x f_1}{\mu} + \frac{g'_2 + x f_2}{\mu^2} + \dots \right] + \frac{\text{Ai}'(x)}{\text{Bi}'(x)} \left[ 1 + \frac{(g_1 + f'_1)}{\mu} + \frac{(g_2 + f'_2)}{\mu^2} + \dots \right] \right\}$$

$$f_1 = (1/5)x^2$$

$$f_2 = \frac{1}{35} (2x^3 + 6)$$

$$f_3 = \frac{1}{63000} (84x^7 + 1480x^4 + 2320x)$$

$$g_1 = -(1/5)x$$

$$g_2 = \frac{1}{350} (7x^5 - 30x^2)$$

$$g_3 = \frac{1}{63000} (1056x^6 - 1160x^3 - 2240)$$

(See chapter 10.)

## 14.5. Asymptotic Expansions

Asymptotic Expansion for Large Values of  $\rho$ 

$$14.5.1 \quad F_L = g \cos \theta_L + f \sin \theta_L$$

$$14.5.2 \quad G_L = f \cos \theta_L - g \sin \theta_L$$

$$14.5.3 \quad F'_L = g^* \cos \theta_L + f^* \sin \theta_L$$

$$14.5.4 \quad G'_L = f^* \cos \theta_L - g^* \sin \theta_L, \quad g f^* - f g^* = 1$$

$$14.5.5 \quad \theta_L = \rho - \eta \ln 2\rho - L \frac{\pi}{2} + \sigma_L$$

$$14.5.6 \quad \sigma_L = \arg \Gamma(L+1+i\eta)$$

(See 6.1.27, 6.1.44.)

$$14.5.7 \quad \sigma_{L+1} = \sigma_L + \arctan \frac{\eta}{L+1}$$

(See Tables 4.14, 6.7.)

$$14.5.8 \quad f \sim \sum_{k=0}^{\infty} f_k, \quad g \sim \sum_{k=0}^{\infty} g_k, \quad f^* \sim \sum_{k=0}^{\infty} f_k^*, \quad g^* \sim \sum_{k=0}^{\infty} g_k^*$$

where

$$f_0=1, \quad g_0=0, \quad f_0^*=0, \quad g_0^*=1-\eta/\rho$$

$$f_{k+1} = a_k f_k - b_k g_k$$

$$g_{k+1} = a_k g_k + b_k f_k$$

$$f_{k+1}^* = a_k f_k^* - b_k g_k^* - f_{k+1}/\rho$$

$$g_{k+1}^* = a_k g_k^* + b_k f_k^* - g_{k+1}/\rho$$

$$a_k = \frac{(2k+1)\eta}{(2k+2)\rho}, \quad b_k = \frac{L(L+1)-k(k+1)+\eta^2}{(2k+2)\rho}$$

\*See page 11.



14.5.9

$$f+ig \sim 1 + \frac{(i\eta-L)(i\eta+L+1)}{1!(2i\rho)} + \frac{(i\eta-L)(i\eta-L+1)(i\eta+L+1)(i\eta+L+2)}{2!(2i\rho)^2} + \frac{(i\eta-L)(i\eta-L+1)(i\eta-L+2)(i\eta+L+1)(i\eta+L+2)(i\eta+L+3)}{3!(2i\rho)^3} + \dots$$

Asymptotic Expansion for  $L=0, \rho=2\eta \gg 0$

14.5.10 
$$\frac{F_0(2\eta)}{G_0(2\eta)/\sqrt{3}} \sim \frac{\Gamma(1/3)\beta^{1/2}}{2\sqrt{\pi}} \left\{ 1 \mp \frac{2}{35} \frac{\Gamma(2/3)}{\Gamma(1/3)} \frac{1}{\beta^4} - \frac{32}{8100} \frac{1}{\beta^6} \mp \frac{92672}{7371 \cdot 10^4} \frac{\Gamma(2/3)}{\Gamma(1/3)} \frac{1}{\beta^{10}} - \dots \right\}$$

14.5.11

$$\frac{F'_0(2\eta)}{G'_0(2\eta)/\sqrt{3}} \sim \frac{\Gamma(2/3)}{2\sqrt{\pi}\beta^{3/2}} \left\{ \pm 1 + \frac{1}{15} \frac{\Gamma(1/3)}{\Gamma(2/3)} \frac{1}{\beta^2} \pm \frac{8}{56700} \frac{1}{\beta^6} + \frac{11488}{18711 \cdot 10^3} \frac{\Gamma(1/3)}{\Gamma(2/3)} \frac{1}{\beta^8} \pm \dots \right\}$$

$$\beta = (2\eta/3)^{3/4}, \Gamma(1/3) = 2.6789 38534 \dots, \Gamma(2/3) = 1.3541 17939 \dots$$

14.5.12

$$G_0(2\eta) \sim \left\{ \begin{matrix} .70633 & 26373 \\ 1.22340 & 4016 \end{matrix} \right\} \eta^{1/2} \left\{ 1 \mp \frac{.04959 \ 570165}{\eta^{3/2}} - \frac{.00888 \ 88888 \ 89}{\eta^2} \mp \frac{.00245 \ 51991 \ 81}{\eta^{9/2}} - \frac{.00091 \ 08958 \ 061}{\eta^4} \mp \frac{.00025 \ 34684 \ 115}{\eta^{13/2}} - \dots \right\}$$

14.5.13

$$G'_0(2\eta) \sim \left\{ \begin{matrix} .40869 \ 57323 \\ -.70788 \ 17734 \end{matrix} \right\} \eta^{-1/2} \left\{ 1 \pm \frac{.17282 \ 60369}{\eta^{3/2}} + \frac{.00031 \ 74603 \ 174}{\eta^2} \pm \frac{.00358 \ 12148 \ 50}{\eta^{9/2}} + \frac{.00031 \ 17824 \ 680}{\eta^4} \pm \frac{.00090 \ 73966 \ 427}{\eta^{13/2}} + \dots \right\}$$

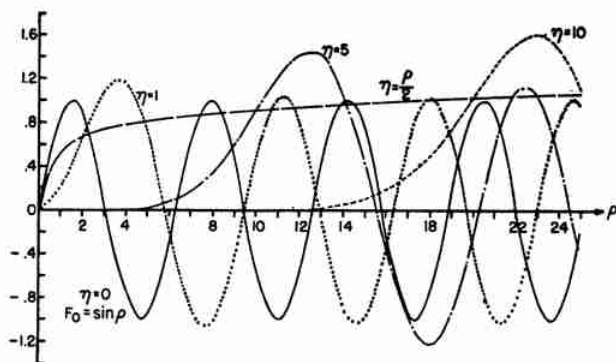

FIGURE 14.3.  $F_0(\eta, \rho)$ .  
 $\eta = 0, 1, 5, 10, \rho/2$

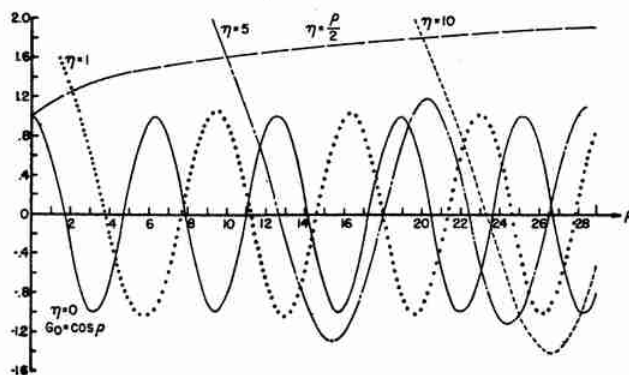

FIGURE 14.5.  $G_0(\eta, \rho)$ .  
 $\eta = 0, 1, 5, 10, \rho/2$

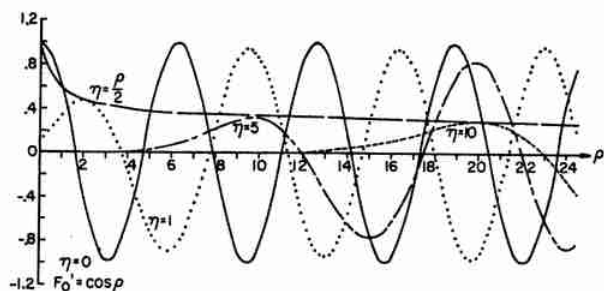

FIGURE 14.4.  $F'_0(\eta, \rho)$ .  
 $\eta = 0, 1, 5, 10, \rho/2$

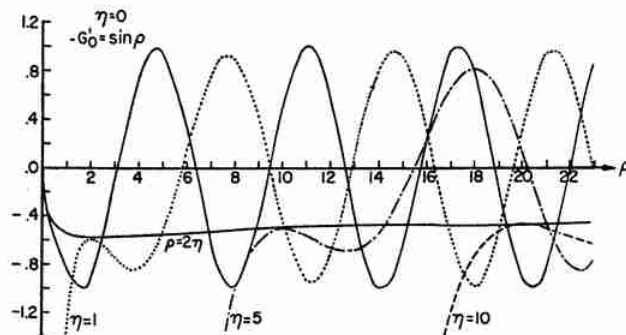

FIGURE 14.6.  $G'_0(\eta, \rho)$ .  
 $\eta = 0, 1, 5, 10, \rho/2$

## 14.6. Special Values and Asymptotic Behavior

14.6.1  $L > 0, \rho = 0$

$$F_L = 0, F'_L = 0$$

$$G_L = \infty, G'_L = -\infty$$

14.6.2  $L = 0, \rho = 0$

$$F_0 = 0, F'_0 = C_0(\eta)$$

$$G_0 = 1/C_0(\eta), G'_0 = -\infty$$

14.6.3  $L \rightarrow \infty$

$$F_L \sim C_L(\eta)\rho^{L+1}, G_L \sim D_L(\eta)\rho^{-L}$$

14.6.4  $L = 0, \eta = 0$

$$F_0 = \sin \rho, F'_0 = \cos \rho$$

$$G_0 = \cos \rho, G'_0 = -\sin \rho$$

14.6.5  $\rho \rightarrow \infty$

$$G_L + iF_L \sim \exp i[\rho - \eta \ln 2\rho - \frac{L\pi}{2} + \sigma_L]$$

14.6.6  $L \geq 0, \eta = 0$

$$F_L = (\frac{1}{2}\pi\rho)^{\frac{1}{2}} J_{L+\frac{1}{2}}(\rho)$$

$$G_L = (-1)^L (\frac{1}{2}\pi\rho)^{\frac{1}{2}} J_{-L-\frac{1}{2}}(\rho)$$

14.6.7  $L \geq 0, 2\eta \gg \rho$

$$F_L \sim \frac{(2L+1)!C_L(\eta)}{(2\eta)^{L+1}} (2\eta\rho)^{\frac{1}{2}} I_{2L+1}[2(2\eta\rho)^{\frac{1}{2}}]$$

$$G_L \sim \frac{2(2\eta)^L}{(2L+1)!C_L(\eta)} (2\eta\rho)^{\frac{1}{2}} K_{2L+1}[2(2\eta\rho)^{\frac{1}{2}}]$$

14.6.8  $L = 0, 2\eta \gg \rho$

$$F_0 \sim e^{-\pi\eta} (\pi\rho)^{\frac{1}{2}} I_1[2(2\eta\rho)^{\frac{1}{2}}]$$

$$F'_0 \sim e^{-\pi\eta} (2\pi\eta)^{\frac{1}{2}} I_0[2(2\eta\rho)^{\frac{1}{2}}]$$

$$G_0 \sim 2e^{\pi\eta} \left(\frac{\rho}{\pi}\right)^{\frac{1}{2}} K_1[2(2\eta\rho)^{\frac{1}{2}}]$$

$$G'_0 \sim -2 \left(\frac{2\eta}{\pi}\right)^{\frac{1}{2}} e^{\pi\eta} K_0[2(2\eta\rho)^{\frac{1}{2}}]$$

14.6.9  $L = 0, 2\eta \gg \rho$

$$F_0 \sim \frac{1}{2} \beta e^\alpha; F'_0 \sim \frac{1}{2} \beta^{-1} e^\alpha$$

$$G_0 \sim \beta e^{-\alpha}; G'_0 \sim -\beta^{-1} e^{-\alpha}$$

$$\alpha = 2\sqrt{2\eta\rho} - \pi\eta$$

$$\beta = (\rho/2\eta)^{\frac{1}{2}}$$

14.6.10  $L = 0, 2\eta \gg \rho$

$$F_0 \sim \frac{1}{2} \beta e^\alpha; F'_0 \sim \left\{ \beta^{-2} + \frac{1}{8\eta} t^{-2}\beta^4 \right\} F_0$$

$$G_0 \sim \beta e^{-\alpha}; G'_0 \sim \left\{ -\beta^{-2} + \frac{1}{8\eta} t^{-2}\beta^4 \right\} G_0$$

$$t = \rho/2\eta$$

$$\alpha = 2\eta \{ [t(1-t)]^{\frac{1}{2}} + \arcsin t^{\frac{1}{2}} - \frac{1}{2}\pi \}$$

$$\beta = \{ t/(1-t) \}^{\frac{1}{2}}$$

14.6.11  $L = 0, \rho \gg 2\eta$

$$F_0 = \alpha \sin \beta; F'_0 = -t^2(bF_0 - aG_0)$$

$$G_0 = \alpha \cos \beta; G'_0 = -t^2(aF_0 + bG_0)$$

$$t = \frac{2\eta}{\rho}$$

$$\alpha = \left(\frac{1}{1-t}\right)^{\frac{1}{2}} \exp \left[ -\frac{8t^3 - 3t^4}{64(2\eta)^2(1-t)^3} \right]$$

$$\beta = \frac{\pi}{4} + 2\eta \left\{ \frac{(1-t)^{\frac{1}{2}}}{t} + \frac{1}{2} \ln \left[ \frac{1-(1-t)^{\frac{1}{2}}}{1+(1-t)^{\frac{1}{2}}} \right] \right\}$$

$$a = t^{-2}(1-t)^{\frac{1}{2}}, b = [8\eta(1-t)]^{-1}$$

14.6.12  $\eta \gg 0, 2\eta \sim \rho$

$$\frac{F_L(\eta, \rho)}{G_L(\eta, \rho)} \sim \sqrt{\pi} \left\{ \frac{\rho_L}{1 + \frac{L(L+1)}{\rho_L^2}} \right\}^{1/6} \begin{Bmatrix} \text{Ai}(x) \\ \text{Bi}(x) \end{Bmatrix}$$

$$\rho_L = \eta + [\eta^2 + L(L+1)]^{1/2}$$

$$x = (\rho_L - \eta) \left[ \frac{1}{\rho_L} + \frac{L(L+1)}{\rho_L^3} \right]^{1/3}$$

14.6.13  $\eta \gg 0, 2\eta \sim \rho$

$$x = (2\eta - \rho)(2\eta)^{-1/3}$$

$$[G_0 + iF_0] \sim \pi^{1/2} (2\eta)^{1/6} [\text{Bi}(x) + i\text{Ai}(x)]$$

$$[G'_0 + iF'_0] \sim -\pi^{1/2} (2\eta)^{-1/6} [\text{Bi}'(x) + i\text{Ai}'(x)]$$

14.6.14  $\eta \gg 0$

$$\rho_L = \eta + [\eta^2 + L(L+1)]^{1/2}$$

$$\frac{F_L(\rho_L)}{G_L(\rho_L)/\sqrt{3}} \sim \frac{\Gamma(1/3)}{2\sqrt{\pi}} \left(\frac{\rho_L}{3}\right)^{1/6} \left\{ 1 + \frac{L(L+1)}{\rho_L^2} \right\}^{-1/6}$$

$$\frac{F'_L(\rho_L)}{G'_L(\rho_L)/\sqrt{3}} \sim \pm \frac{\Gamma(2/3)}{2\sqrt{\pi}} \left(\frac{\rho_L}{3}\right)^{-1/6} \left\{ 1 + \frac{L(L+1)}{\rho_L^2} \right\}^{1/6}$$

14.6.15  $\rho=2\eta >> 0$   

$$F_0 \sim \frac{\Gamma(1/3)}{2\sqrt{\pi}} \left(\frac{2\eta}{3}\right)^{1/6}$$

$$G_0/\sqrt{3} \sim \frac{\Gamma(1/3)}{2\sqrt{\pi}} \left(\frac{2\eta}{3}\right)^{1/6}$$

$$F'_0 \sim \frac{\Gamma(2/3)}{2\sqrt{\pi}(2\eta/3)^{1/6}}$$

$$-G'_0/\sqrt{3} \sim \frac{\Gamma(2/3)}{2\sqrt{\pi}(2\eta/3)^{1/6}}$$

14.6.16  $\eta \rightarrow \infty$   

$$\sigma_0(\eta) \sim \left[\frac{\pi}{4} + \eta(\ln \eta - 1)\right]$$

$$C_0(\eta) \sim (2\pi\eta)^{1/2} e^{-\pi\eta}$$
 (Equality to 8S for  $\eta > 3$ .)

14.6.17  $\eta \rightarrow 0$   

$$\sigma_0(\eta) \sim -\gamma\eta \quad (\gamma = \text{Euler's constant})$$

$$C_L(\eta) \sim \frac{2^L L!}{(2L+1)!}$$

14.6.18  $L \rightarrow \infty$   

$$C_L(\eta) \sim \frac{2^L L!}{(2L+1)!} e^{-\pi\eta/2}$$

**Numerical Methods**

**14.7. Use and Extension of the Tables**

In general the tables as presented are not simply interpolable. However, values for  $L > 0$  may be obtained with the help of the recurrence relations. The values of  $G_L(\eta, \rho)$  may be obtained by applying the recurrence relations in increasing order of  $L$ . Forward recurrence may be used for  $F_L(\eta, \rho)$  as long as the instability does not produce errors in excess of the accuracy needed. In this case the backwards recurrence scheme (see **Example 1**) should be used.

**Example 1.** Compute  $F_L(\eta, \rho)$  and  $F'_L(\eta, \rho)$  for  $\eta=2, \rho=5, L=0(1)5$ . Starting with  $F_{10}^*=1, F'_{11}=0$ , where  $F_L^*=cF_L$ , we compute from 14.2.3 in decreasing order of  $L$ :

| $L$ | (1)<br>$F_L^*$ | (2)<br>$F_L$ | (3)<br>$F_L$ | (4)<br>$F'_L$ |
|-----|----------------|--------------|--------------|---------------|
| 11  | 0.             |              |              |               |
| 10  | 1.             |              |              |               |
| 9   | 4.49284        |              |              |               |
| 8   | 17.5225        |              |              |               |
| 7   | 61.3603        |              |              |               |
| 6   | 191.238        |              |              |               |
| 5   | 523.472        | .090791      | .091         | .1043         |
| 4   | 1238.53        | .21481       | .215         | .2030         |
| 3   | 2486.72        | .43130       | .4313        | .3205         |
| 2   | 4158.46        | .72124       | .72125       | .3952         |
| 1   | 5727.97        | .99346       | .99347       | .3709         |
| 0   | 6591.81        | 1.1433       | 1.1433       | .29380        |

$F_0/F_0^* = 1.7344 \times 10^{-4} = c^{-1}$ .

The values in the second column are obtained from those in the first by multiplying by the normalization constant,  $F_0/F_0^*$  where  $F_0$  is the known value obtained from **Table 14.1**.

Repetition starting with  $F'_{15}=1$  and  $F_{16}=0$  yields the same results.

In column 3, the results have been given when 14.2.3 is used in increasing order of  $L$ .

$F'_L$  (column 4) follows from 14.2.2.

**Example 2.** Compute  $G_L(\eta, \rho)$  and  $G'_L(\eta, \rho)$  for  $\eta=2, \rho=5, L=1(1)5$ .

Using 14.2.2 and  $G_0(2, 5) = .79445, G'_0 = -.67049$  from **Table 14.1** we find  $G_1(2, 5) = 1.0815$ . Then by forward recurrence using 14.2.3 we find:

| $L$ | $G_L$  | $-G'_L$ * |
|-----|--------|-----------|
| 1   | 1.0815 | .60286    |
| 2   | 1.4969 | .56619    |
| 3   | 2.0487 | .79597    |
| 4   | 3.0941 | 1.7318    |
| 5   | 5.6298 | 4.5493    |

The values of  $G'_L$  are obtained with 14.2.1.

**Example 3.** Compute  $G_0(\eta, \rho)$  for  $\eta=2, \rho=2.5$ . From **Table 14.1**,  $G_0(2, 2) = 3.5124, G'_0(2, 2) = -2.5554$ . Successive differentiation of 14.1.1 for  $L=0$  gives

$$\rho \frac{d^{k+2}w}{d\rho^{k+2}} = (2\eta - \rho) \frac{d^k w}{d\rho^k} - k \left\{ \frac{d^{k+1}w}{d\rho^{k+1}} + \frac{d^{k-1}w}{d\rho^{k-1}} \right\}$$

Taylor's expansion is  $w(\rho + \Delta\rho) = w(\rho) + (\Delta\rho)w' + \frac{(\Delta\rho)^2}{2!} w'' + \dots$ . With  $w = G_0(\eta, \rho)$  and  $\Delta\rho = .5$

we get:

| $k$ | $\frac{d^k G_0}{d\rho^k}$ | $\frac{(\Delta\rho)^k}{k!} \frac{d^k G_0}{d\rho^k}$ |
|-----|---------------------------|---|
| 0   | 3.5124                    | 3.5124  |
| 1   | -2.5554                   | -1.2777   |
| 2   | 3.5124                    | .43905  |
| 3   | -6.0678                   | -.12641   |
| 4   | 12.136                    | .03160  |
| 5   | -29.540                   | -.00769   |
| 6   | 83.352                    | .00181  |
| 7   | -268.26                   | -.00042   |

$G_0(2, 2.5) = 2.5726$

As a check the result is obtained with  $\eta=2, \rho=3, \Delta\rho = -.5$ . The derivative  $G'_0(\eta, \rho)$  may be obtained using Taylor's formula with  $w = G'_0(\eta, \rho)$ .

\*See page II.

## References

## Texts

- [14.1] M. Abramowitz and H. A. Antosiewicz, Coulomb wave functions in the transition region. *Phys. Rev.* **96**, 75-77 (1954).
- [14.2] Biedenharn, Gluckstern, Hull, and Breit, Coulomb functions for large charges and small velocities. *Phys. Rev.* **97**, 542 (1955).
- [14.3] I. Bloch et al., Coulomb functions for reactions of protons and alpha-particles with the lighter nuclei. *Rev. Mod. Phys.* **23**, 147-182 (1951).
- [14.4] Carl-Erik Fröberg, Numerical treatment of Coulomb wave functions. *Rev. Mod. Phys.* **27**, 399-411 (1955).
- [14.5] I. A. Stegun and M. Abramowitz, Generation of Coulomb wave functions from their recurrence relations. *Phys. Rev.* **98**, 1851 (1955).

## Tables

- [14.6] M. Abramowitz and P. Rabinowitz, Evaluation of Coulomb wave functions along the transition line. *Phys. Rev.* **96**, 77-79 (1954). Tabulates  $F_0, F'_0, G_0, G'_0$  for  $\rho=2\eta=0(.5)20(2)50$ , 8S.
- [14.7] National Bureau of Standards, Tables of Coulomb wave functions, vol. I, Applied Math. Series 17 (U.S. Government Printing Office, Washington, D.C., 1952). Tabulates  $\Phi_L(\eta, \rho)$  and  $\frac{1}{k!} \frac{d^k \Phi_k(\eta, \rho)}{d\eta^k}$  for  $\rho=0(.2)5$ ,  $\eta=-5(1)5$ ,  $L=0(1)5, 10, 11, 20, 21, 7D$ .
- [14.8] Numerical Computation Bureau, Tables of Whittaker functions (Wave functions in a Coulomb field). Report No. 9, Japan (1956).
- [14.9] A. Tubis, Tables of non-relativistic Coulomb wave functions, Los Alamos Scientific Laboratory La-2150, Los Alamos, N. Mex. (1958). Values of  $F_0, F'_0, G_0, G'_0$ ,  $\rho=0(.2)40$ ;  $\eta=0(.05)12$ , 5S.

# 15. Hypergeometric Functions

FRITZ OBERHETTINGER<sup>1</sup>

## Contents

|   | Page |
|---|------|
| <b>Mathematical Properties</b> . . . . .  | 556  |
| 15.1. Gauss Series, Special Elementary Cases, Special Values of<br>the Argument . . . . . | 556  |
| 15.2. Differentiation Formulas and Gauss' Relations for Contiguous<br>Functions. . . . .  | 557  |
| 15.3. Integral Representations and Transformation Formulas . . .                          | 558  |
| 15.4. Special Cases of $F(a, b; c; z)$ , Polynomials and Legendre<br>Functions. . . . .   | 561  |
| 15.5. The Hypergeometric Differential Equation . . . . .                                  | 562  |
| 15.6. Riemann's Differential Equation . . . . .   | 564  |
| 15.7. Asymptotic Expansions . . . . .   | 565  |
| <b>References</b> . . . . .   | 565  |

---

<sup>1</sup> National Bureau of Standards. (Presently, Oregon State University, Corvallis, Oregon.)

# 15. Hypergeometric Functions

## Mathematical Properties

### 15.1. Gauss Series, Special Elementary Cases, Special Values of the Argument

#### Gauss Series

The circle of convergence of the Gauss hypergeometric series

#### 15.1.1

$$F(a, b; c; z) = {}_2F_1(a, b; c; z)$$

$$= F(b, a; c; z) = \sum_{n=0}^{\infty} \frac{(a)_n (b)_n}{(c)_n} \frac{z^n}{n!}$$

$$= \frac{\Gamma(c)}{\Gamma(a)\Gamma(b)} \sum_{n=0}^{\infty} \frac{\Gamma(a+n)\Gamma(b+n)}{\Gamma(c+n)} \frac{z^n}{n!}$$

is the unit circle  $|z|=1$ . The behavior of this series on its circle of convergence is:

- (a) Divergence when  $\Re(c-a-b) \leq -1$ .
- (b) Absolute convergence when  $\Re(c-a-b) > 0$ .
- (c) Conditional convergence when  $-1 < \Re(c-a-b) \leq 0$ ; the point  $z=1$  is excluded. The Gauss series reduces to a polynomial of degree  $n$  in  $z$  when  $a$  or  $b$  is equal to  $-n$ , ( $n=0, 1, 2, \dots$ ). (For these cases see also 15.4.) The series 15.1.1 is not defined when  $c$  is equal to  $-m$ , ( $m=0, 1, 2, \dots$ ), provided  $a$  or  $b$  is not a negative integer  $n$  with  $n < m$ . For  $c = -m$

#### 15.1.2

$$\lim_{c \rightarrow -m} \frac{1}{\Gamma(c)} F(a, b; c; z) =$$

$$\frac{(a)_{m+1}(b)_{m+1}}{(m+1)!} z^{m+1} F(a+m+1, b+m+1; m+2; z)$$

#### Special Elementary Cases of Gauss Series

(For cases involving higher functions see 15.4.)

$$15.1.3 \quad F(1, 1; 2; z) = -z^{-1} \ln(1-z) \quad *$$

$$15.1.4 \quad F\left(\frac{1}{2}, 1; \frac{3}{2}; z^2\right) = \frac{1}{2} z^{-1} \ln\left(\frac{1+z}{1-z}\right)$$

$$15.1.5 \quad F\left(\frac{1}{2}, 1; \frac{3}{2}; -z^2\right) = z^{-1} \arctan z$$

#### 15.1.6

$$F\left(\frac{1}{2}, \frac{1}{2}; \frac{3}{2}; z^2\right) = (1-z^2)^{-1/2} F(1, 1; \frac{3}{2}; z^2) = z^{-1} \arcsin z$$

#### 15.1.7

$$F\left(\frac{1}{2}, \frac{1}{2}; \frac{3}{2}; -z^2\right) = (1+z^2)^{-1/2} F(1, 1; \frac{3}{2}; -z^2)$$

$$= z^{-1} \ln[z + (1+z^2)^{1/2}]$$

$$15.1.8 \quad F(a, b; b; z) = (1-z)^{-a}$$

$$15.1.9 \quad F(a, \frac{1}{2}+a; \frac{3}{2}; z^2) = \frac{1}{2} [(1+z)^{-2a} + (1-z)^{-2a}]$$

#### 15.1.10

$$F(a, \frac{1}{2}+a; \frac{3}{2}; z^2) =$$

$$\frac{1}{2} z^{-1} (1-2a)^{-1} [(1+z)^{1-2a} - (1-z)^{1-2a}]$$

#### 15.1.11

$$F(-a, a; \frac{1}{2}; -z^2) = \frac{1}{2} \{ [(1+z^2)^{1/2} + z]^{2a} + [(1+z^2)^{1/2} - z]^{2a} \}$$

#### 15.1.12

$$F(a, 1-a; \frac{1}{2}; -z^2) =$$

$$\frac{1}{2} (1+z^2)^{-1/2} \{ [(1+z^2)^{1/2} + z]^{2a-1} + [(1+z^2)^{1/2} - z]^{2a-1} \}$$

#### 15.1.13

$$F(a, \frac{1}{2}+a; 1+2a; z) = 2^{2a} [1 + (1-z)^{1/2}]^{-2a}$$

$$= (1-z)^{1/2} F(1+a, \frac{1}{2}+a; 1+2a; z)$$

#### 15.1.14

$$F(a, \frac{1}{2}+a; 2a; z) = 2^{2a-1} (1-z)^{-1/2} [1 + (1-z)^{1/2}]^{1-2a}$$

$$15.1.15 \quad F(a, 1-a; \frac{3}{2}; \sin^2 z) = \frac{\sin[(2a-1)z]}{(2a-1)\sin z}$$

$$15.1.16 \quad F(a, 2-a; \frac{3}{2}; \sin^2 z) = \frac{\sin[(2a-2)z]}{(a-1)\sin(2z)}$$

$$15.1.17 \quad F(-a, a; \frac{1}{2}; \sin^2 z) = \cos(2az)$$

$$15.1.18 \quad F(a, 1-a; \frac{1}{2}; \sin^2 z) = \frac{\cos[(2a-1)z]}{\cos z}$$

$$15.1.19 \quad F(a, \frac{1}{2}+a; \frac{1}{2}; -\tan^2 z) = \cos^{2a} z \cos(2az)$$

#### Special Values of the Argument

#### 15.1.20

$$F(a, b; c; 1) = \frac{\Gamma(c)\Gamma(c-a-b)}{\Gamma(c-a)\Gamma(c-b)}$$

$$(c \neq 0, -1, -2, \dots, \Re(c-a-b) > 0)$$

\*See page II.

15.1.21

$$F(a, b; a-b+1; -1) = 2^{-a} \pi^{\frac{1}{2}} \frac{\Gamma(1+a-b)}{\Gamma(1+\frac{1}{2}a-b)\Gamma(\frac{1}{2}+\frac{1}{2}a)}$$

(1+a-b ≠ 0, -1, -2, . . .)

15.1.22

$$F(a, b; a-b+2; -1) = 2^{-a} \pi^{1/2} (b-1)^{-1} \Gamma(a-b+2)$$

$$\left[ \frac{1}{\Gamma(\frac{1}{2}a)\Gamma(\frac{3}{2}+\frac{1}{2}a-b)} - \frac{1}{\Gamma(\frac{1}{2}+\frac{1}{2}a)\Gamma(1+\frac{1}{2}a-b)} \right]$$

(a-b+2 ≠ 0, -1, -2, . . .)

15.1.23  $F(1, a; a+1; -1) = \frac{1}{2} a [\psi(\frac{1}{2}+\frac{1}{2}a) - \psi(\frac{1}{2}a)]$

15.1.24

$$F(a, b; \frac{1}{2}a+\frac{1}{2}b+\frac{1}{2}; \frac{1}{2}) = \pi^{\frac{1}{2}} \frac{\Gamma(\frac{1}{2}+\frac{1}{2}a+\frac{1}{2}b)}{\Gamma(\frac{1}{2}+\frac{1}{2}a)\Gamma(\frac{1}{2}+\frac{1}{2}b)}$$

(\frac{1}{2}a+\frac{1}{2}b+\frac{1}{2} ≠ 0, -1, -2, . . .)

15.1.25

$$F(a, b; \frac{1}{2}a+\frac{1}{2}b+1; \frac{1}{2}) = 2\pi^{\frac{1}{2}}(a-b)^{-1} \Gamma(1+\frac{1}{2}a+\frac{1}{2}b)$$

$$\{[\Gamma(\frac{1}{2}a)\Gamma(\frac{1}{2}+\frac{1}{2}b)]^{-1} - [\Gamma(\frac{1}{2}+\frac{1}{2}a)\Gamma(\frac{1}{2}b)]^{-1}\}$$

(\frac{1}{2}(a+b)+1 ≠ 0, -1, -2, . . .)

15.1.26

$$F(a, 1-a; b; \frac{1}{2}) = 2^{1-b} \pi^{\frac{1}{2}} \Gamma(b) [\Gamma(\frac{1}{2}a+\frac{1}{2}b) \Gamma(\frac{1}{2}+\frac{1}{2}b-\frac{1}{2}a)]^{-1}$$

(b ≠ 0, -1, -2, . . .)

15.1.27

$$F(1, 1; a+1; \frac{1}{2}) = a[\psi(\frac{1}{2}+\frac{1}{2}a) - \psi(\frac{1}{2}a)]$$

(a ≠ -1, -2, -3, . . .)

15.1.28

$$F(a, a; a+1; \frac{1}{2}) = 2^{-a} a [\psi(\frac{1}{2}+\frac{1}{2}a) - \psi(\frac{1}{2}a)]$$

(a ≠ -1, -2, -3, . . .)

15.1.29

$$F(a, \frac{1}{2}+a; \frac{3}{2}-2a; -\frac{1}{3}) = (\frac{2}{3})^{-2a} \frac{\Gamma(\frac{1}{3})\Gamma(\frac{2}{3}-2a)}{\Gamma(\frac{2}{3})\Gamma(\frac{1}{3}-2a)}$$

(\frac{3}{2}-2a ≠ 0, -1, -2, . . .)

15.1.30

$$F(a, \frac{1}{2}+a; \frac{5}{6}+a; \frac{1}{3}) = (\frac{2}{3})^a \pi^{\frac{1}{2}} \frac{\Gamma(\frac{5}{6}+\frac{1}{2}a)}{\Gamma(\frac{1}{2}+\frac{1}{2}a)\Gamma(\frac{5}{6}+\frac{1}{2}a)}$$

(\frac{5}{6}+\frac{1}{2}a ≠ 0, -1, -2, . . .)

15.1.31

$$F(a, \frac{1}{3}a+\frac{1}{3}; \frac{2}{3}a+\frac{2}{3}; e^{1/\pi^3})$$

$$= 2^{\frac{2}{3}a+\frac{2}{3}} \pi^{\frac{1}{2}} 3^{-\frac{1}{2}(a+1)} e^{1/\pi^3} \frac{\Gamma(\frac{1}{3}a+\frac{1}{3})}{\Gamma(\frac{1}{3}a+\frac{2}{3})\Gamma(\frac{2}{3})}$$

(\frac{1}{3}a ≠ -\frac{5}{6}, -1\frac{1}{3}, -1\frac{2}{3}, . . .)

15.2. Differentiation Formulas and Gauss' Relations for Contiguous Functions

Differentiation Formulas

15.2.1  $\frac{d}{dz} F(a, b; c; z) = \frac{ab}{c} F(a+1, b+1; c+1; z)$

15.2.2

$$\frac{d^n}{dz^n} F(a, b; c; z) = \frac{(a)_n (b)_n}{(c)_n} F(a+n, b+n; c+n; z)$$

15.2.3

$$\frac{d^n}{dz^n} [z^{a+n-1} F(a, b; c; z)] = (a)_n z^{a-1} F(a+n, b; c; z)$$

15.2.4

$$\frac{d^n}{dz^n} [z^{c-1} F(a, b; c; z)] = (c-n)_n z^{c-n-1} F(a, b; c-n; z)$$

15.2.5

$$\frac{d^n}{dz^n} [z^{c-a+n-1} (1-z)^{a+b-c} F(a, b; c; z)]$$

$$= (c-a)_n z^{c-a-1} (1-z)^{a+b-c-n} F(a-n, b; c; z)$$

15.2.6

$$\frac{d^n}{dz^n} [(1-z)^{a+b-c} F(a, b; c; z)]$$

$$= \frac{(c-a)_n (c-b)_n}{(c)_n} (1-z)^{a+b-c-n} F(a, b; c+n; z)$$

15.2.7

$$\frac{d^n}{dz^n} [(1-z)^{a+n-1} F(a, b; c; z)]$$

$$= \frac{(-1)^n (a)_n (c-b)_n}{(c)_n} (1-z)^{a-1} F(a+n, b; c+n; z)$$

15.2.8

$$\frac{d^n}{dz^n} [z^{c-1} (1-z)^{b-c+n} F(a, b; c; z)]$$

$$= (c-n)_n z^{c-n-1} (1-z)^{b-c} F(a-n, b; c-n; z)$$

15.2.9

$$\frac{d^n}{dz^n} [z^{c-1} (1-z)^{a+b-c} F(a, b; c; z)]$$

$$= (c-n)_n z^{c-n-1} (1-z)^{a+b-c-n} F(a-n, b-n; c-n; z)$$

Gauss' Relations for Contiguous Functions

The six functions  $F(a \pm 1, b; c; z)$ ,  $F(a, b \pm 1; c; z)$ ,  $F(a, b; c \pm 1; z)$  are called contiguous to  $F(a, b; c; z)$ . Relations between  $F(a, b; c; z)$  and



any two contiguous functions have been given by Gauss. By repeated application of these relations the function  $F(a+m, b+n; c+l; z)$  with integral  $m, n, l$  ( $c+l \neq 0, -1, -2, \dots$ ) can be expressed as a linear combination of  $F(a, b; c; z)$  and one of its contiguous functions with coefficients which are rational functions of  $a, b, c, z$ .

**15.2.10**

$$(c-a)F(a-1, b; c; z) + (2a-c-az+bz)F(a, b; c; z) \\ + a(z-1)F(a+1, b; c; z) = 0$$

**15.2.11**

$$(c-b)F(a, b-1; c; z) + (2b-c-bz+az)F(a, b; c; z) \\ + b(z-1)F(a, b+1; c; z) = 0$$

**15.2.12**

$$c(c-1)(z-1)F(a, b; c-1; z) \\ + c[c-1-(2c-a-b-1)z]F(a, b; c; z) \\ + (c-a)(c-b)zF(a, b; c+1; z) = 0$$

**15.2.13**

$$[c-2a-(b-a)z]F(a, b; c; z) \\ + a(1-z)F(a+1, b; c; z) \\ - (c-a)F(a-1, b; c; z) = 0$$

**15.2.14**

$$(b-a)F(a, b; c; z) + aF(a+1, b; c; z) \\ - bF(a, b+1; c; z) = 0$$

**15.2.15**

$$(c-a-b)F(a, b; c; z) + a(1-z)F(a+1, b; c; z) \\ - (c-b)F(a, b-1; c; z) = 0$$

**15.2.16**

$$c[a-(c-b)z]F(a, b; c; z) - ac(1-z)F(a+1, b; c; z) \\ + (c-a)(c-b)zF(a, b; c+1; z) = 0$$

**15.2.17**

$$(c-a-1)F(a, b; c; z) + aF(a+1, b; c; z) \\ - (c-1)F(a, b; c-1; z) = 0$$

**15.2.18**

$$(c-a-b)F(a, b; c; z) - (c-a)F(a-1, b; c; z) \\ + b(1-z)F(a, b+1; c; z) = 0$$

**15.2.19**

$$(b-a)(1-z)F(a, b; c; z) - (c-a)F(a-1, b; c; z) \\ + (c-b)F(a, b-1; c; z) = 0$$

**15.2.20**

$$c(1-z)F(a, b; c; z) - cF(a-1, b; c; z) \\ + (c-b)zF(a, b; c+1; z) = 0$$

**15.2.21**

$$[a-1-(c-b-1)z]F(a, b; c; z) \\ + (c-a)F(a-1, b; c; z) \\ - (c-1)(1-z)F(a, b; c-1; z) = 0$$

**15.2.22**

$$[c-2b+(b-a)z]F(a, b; c; z) \\ + b(1-z)F(a, b+1; c; z) \\ - (c-b)F(a, b-1; c; z) = 0$$

**15.2.23**

$$c[b-(c-a)z]F(a, b; c; z) - bc(1-z)F(a, b+1; c; z) \\ + (c-a)(c-b)zF(a, b; c+1; z) = 0$$

**15.2.24**

$$(c-b-1)F(a, b; c; z) + bF(a, b+1; c; z) \\ - (c-1)F(a, b; c-1; z) = 0$$

**15.2.25**

$$c(1-z)F(a, b; c; z) - cF(a, b-1; c; z) \\ * + (c-a)zF(a, b; c+1; z) = 0$$

**15.2.26**

$$[b-1-(c-a-1)z]F(a, b; c; z) \\ + (c-b)F(a, b-1; c; z) \\ - (c-1)(1-z)F(a, b; c-1; z) = 0$$

**15.2.27**

$$c[c-1-(2c-a-b-1)z]F(a, b; c; z) \\ + (c-a)(c-b)zF(a, b; c+1; z) \\ - c(c-1)(1-z)F(a, b; c-1; z) = 0$$

**15.3. Integral Representations and Transformation Formulas****Integral Representations****15.3.1**

$$F(a, b; c; z) = \frac{\Gamma(c)}{\Gamma(b)\Gamma(c-b)} \int_0^1 t^{b-1}(1-t)^{c-b-1}(1-tz)^{-a} dt \\ (\Re c > \Re b > 0)$$

The integral represents a one valued analytic function in the  $z$ -plane cut along the real axis from 1 to  $\infty$  and hence 15.3.1 gives the analytic continuation of 15.1.1,  $F(a, b; c; z)$ . Another integral representation is in the form of a Mellin-Barnes integral

$$\begin{aligned}
 15.3.2 \quad F(a, b; c; z) &= \frac{\Gamma(c)}{2\pi i \Gamma(a)\Gamma(b)} \int_{-\infty}^{+\infty} \frac{\Gamma(a+s)\Gamma(b+s)\Gamma(-s)}{\Gamma(c+s)} (-z)^s ds \\
 &= \frac{1}{2}i \frac{\Gamma(c)}{\Gamma(a)\Gamma(b)} \int_{-\infty}^{+\infty} \frac{\Gamma(a+s)\Gamma(b+s)}{\Gamma(1+s)\Gamma(c+s)} \csc(\pi s) (-z)^s ds
 \end{aligned}$$

Here  $-\pi < \arg(-z) < \pi$  and the path of integration is chosen such that the poles of  $\Gamma(a+s)$  and  $\Gamma(b+s)$  i.e. the points  $s = -a - n$  and  $s = -b - m$  ( $n, m = 0, 1, 2, \dots$ ) respectively, are at its left side and the poles of  $\csc(\pi s)$  or  $\Gamma(-s)$  i.e.  $s = 0, 1, 2, \dots$  are at its right side. The cases in which  $-a, -b$  or  $-c$  are non-negative integers or  $a - b$  equal to an integer are excluded.

**Linear Transformation Formulas**

From 15.3.1 and 15.3.2 a number of transformation formulas for  $F(a, b; c; z)$  can be derived.

$$15.3.3 \quad F(a, b; c; z) = (1-z)^{c-a-b} F(c-a, c-b; c; z)$$

$$15.3.4 \quad = (1-z)^{-a} F\left(a, c-b; c; \frac{z}{z-1}\right)$$

$$15.3.5 \quad = (1-z)^{-b} F\left(b, c-a; c; \frac{z}{z-1}\right)$$

$$\begin{aligned}
 15.3.6 \quad &= \frac{\Gamma(c)\Gamma(c-a-b)}{\Gamma(c-a)\Gamma(c-b)} F(a, b; a+b-c+1; 1-z) \\
 &\quad + (1-z)^{c-a-b} \frac{\Gamma(c)\Gamma(a+b-c)}{\Gamma(a)\Gamma(b)} F(c-a, c-b; c-a-b+1; 1-z) \quad (|\arg(1-z)| < \pi)
 \end{aligned}$$

$$\begin{aligned}
 15.3.7 \quad &= \frac{\Gamma(c)\Gamma(b-a)}{\Gamma(b)\Gamma(c-a)} (-z)^{-a} F\left(a, 1-c+a; 1-b+a; \frac{1}{z}\right) \\
 &\quad + \frac{\Gamma(c)\Gamma(a-b)}{\Gamma(a)\Gamma(c-b)} (-z)^{-b} F\left(b, 1-c+b; 1-a+b; \frac{1}{z}\right) \quad (|\arg(-z)| < \pi)
 \end{aligned}$$

$$\begin{aligned}
 15.3.8 \quad &= (1-z)^{-a} \frac{\Gamma(c)\Gamma(b-a)}{\Gamma(b)\Gamma(c-a)} F\left(a, c-b; a-b+1; \frac{1}{1-z}\right) \\
 &\quad + (1-z)^{-b} \frac{\Gamma(c)\Gamma(a-b)}{\Gamma(a)\Gamma(c-b)} F\left(b, c-a; b-a+1; \frac{1}{1-z}\right) \quad (|\arg(1-z)| < \pi)
 \end{aligned}$$

$$\begin{aligned}
 15.3.9 \quad &= \frac{\Gamma(c)\Gamma(c-a-b)}{\Gamma(c-a)\Gamma(c-b)} z^{-a} F\left(a, a-c+1; a+b-c+1; 1-\frac{1}{z}\right) \\
 &\quad + \frac{\Gamma(c)\Gamma(a+b-c)}{\Gamma(a)\Gamma(b)} (1-z)^{c-a-b} z^{a-c} F\left(c-a, 1-a; c-a-b+1; 1-\frac{1}{z}\right) \\
 &\quad (|\arg z| < \pi, |\arg(1-z)| < \pi)
 \end{aligned}$$

Each term of 15.3.6 has a pole when  $c = a + b \pm m$ , ( $m = 0, 1, 2, \dots$ ); this case is covered by

$$\begin{aligned}
 15.3.10 \quad F(a, b; a+b; z) &= \frac{\Gamma(a+b)}{\Gamma(a)\Gamma(b)} \sum_{n=0}^{\infty} \frac{(a)_n (b)_n}{(n!)^2} [2\psi(n+1) - \psi(a+n) - \psi(b+n) - \ln(1-z)] (1-z)^n \\
 &\quad (|\arg(1-z)| < \pi, |1-z| < 1)
 \end{aligned}$$

Furthermore for  $m = 1, 2, 3, \dots$

$$\begin{aligned}
 15.3.11 \quad F(a, b; a+b+m; z) &= \frac{\Gamma(m)\Gamma(a+b+m)}{\Gamma(a+m)\Gamma(b+m)} \sum_{n=0}^{m-1} \frac{(a)_n (b)_n}{n!(1-m)_n} (1-z)^n \\
 &\quad - \frac{\Gamma(a+b+m)}{\Gamma(a)\Gamma(b)} (z-1)^m \sum_{n=0}^{\infty} \frac{(a+m)_n (b+m)_n}{n!(n+m)!} (1-z)^n [\ln(1-z) - \psi(n+1) \\
 &\quad - \psi(n+m+1) + \psi(a+n+m) + \psi(b+n+m)] \quad (|\arg(1-z)| < \pi, |1-z| < 1)
 \end{aligned}$$

$$\begin{aligned}
 15.3.12 \quad F(a, b; a+b-m; z) &= \frac{\Gamma(m)\Gamma(a+b-m)}{\Gamma(a)\Gamma(b)} (1-z)^{-m} \sum_{n=0}^{m-1} \frac{(a-m)_n (b-m)_n}{n!(1-m)_n} (1-z)^n \\
 &\quad - \frac{(-1)^m \Gamma(a+b-m)}{\Gamma(a-m)\Gamma(b-m)} \sum_{n=0}^{\infty} \frac{(a)_n (b)_n}{n!(n+m)!} (1-z)^n [\ln(1-z) - \psi(n+1) \\
 &\quad \quad \quad - \psi(n+m+1) + \psi(a+n) + \psi(b+n)] \\
 &\quad \quad \quad (|\arg(1-z)| < \pi, |1-z| < 1)
 \end{aligned}$$

Similarly each term of 15.3.7 has a pole when  $b=a \pm m$  or  $b-a = \pm m$  and the case is covered by

$$\begin{aligned}
 15.3.13 \quad F(a, a; c; z) &= \frac{\Gamma(c)}{\Gamma(a)\Gamma(c-a)} (-z)^{-a} \sum_{n=0}^{\infty} \frac{(a)_n (1-c+a)_n}{(n!)^2} z^{-n} [\ln(-z) + 2\psi(n+1) - \psi(a+n) - \psi(c-a-n)] \\
 &\quad (|\arg(-z)| < \pi, |z| > 1, (c-a) \neq 0, \pm 1, \pm 2, \dots)
 \end{aligned}$$

The case  $b-a=m$ , ( $m=1, 2, 3, \dots$ ) is covered by

$$\begin{aligned}
 15.3.14 \quad F(a, a+m; c; z) &= F(a+m, a; c; z) \\
 &= \frac{\Gamma(c)(-z)^{-a-m}}{\Gamma(a+m)\Gamma(c-a)} \sum_{n=0}^{\infty} \frac{(a)_{n+m} (1-c+a)_{n+m}}{n!(n+m)!} z^{-n} [\ln(-z) + \psi(1+m+n) + \psi(1+n) \\
 &\quad \quad \quad - \psi(a+m+n) - \psi(c-a-m-n)] + (-z)^{-a} \frac{\Gamma(c)}{\Gamma(a+m)} \sum_{n=0}^{m-1} \frac{\Gamma(m-n)(a)_n}{n!\Gamma(c-a-n)} z^{-n} \\
 &\quad \quad \quad (|\arg(-z)| < \pi, |z| > 1, (c-a) \neq 0, \pm 1, \pm 2, \dots)
 \end{aligned}$$

The case  $c-a=0, -1, -2, \dots$  becomes elementary, 15.3.3, and the case  $c-a=1, 2, 3, \dots$  can be obtained from 15.3.14, by a limiting process (see [15.2]).

#### Quadratic Transformation Formulas

If, and only if the numbers  $\pm(1-c)$ ,  $\pm(a-b)$ ,  $\pm(a+b-c)$  are such, that two of them are equal or one of them is equal to  $\frac{1}{2}$ , then there exists a quadratic transformation. The basic formulas are due to Kummer [15.7] and a complete list is due to Goursat [15.3]. See also [15.2].

$$\begin{aligned}
 15.3.15 \quad F(a, b; 2b; z) &= (1-z)^{-1/2} F\left(\frac{1}{2}a, b-\frac{1}{2}a; b+\frac{1}{2}; \frac{z^2}{4z-4}\right) \\
 15.3.16 \quad &= (1-\frac{1}{2}z)^{-a} F\left(\frac{1}{2}a, \frac{1}{2}+\frac{1}{2}a; b+\frac{1}{2}; z^2(2-z)^{-2}\right) \\
 15.3.17 \quad &= \left(\frac{1}{2}+\frac{1}{2}\sqrt{1-z}\right)^{-2a} F\left[a, a-b+\frac{1}{2}; b+\frac{1}{2}; \left(\frac{1-\sqrt{1-z}}{1+\sqrt{1-z}}\right)^2\right] \\
 15.3.18 \quad &= (1-z)^{-1/2} F\left(a, 2b-a; b+\frac{1}{2}; -\frac{(1-\sqrt{1-z})^2}{4\sqrt{1-z}}\right) \\
 15.3.19 \quad F(a, a+\frac{1}{2}; c; z) &= \left(\frac{1}{2}+\frac{1}{2}\sqrt{1-z}\right)^{-2a} F\left(2a, 2a-c+1; c; \frac{1-\sqrt{1-z}}{1+\sqrt{1-z}}\right) \\
 15.3.20 \quad &= (1 \pm \sqrt{z})^{-2a} F\left(2a, c-\frac{1}{2}; 2c-1; \pm \frac{2\sqrt{z}}{1 \pm \sqrt{z}}\right) \\
 15.3.21 \quad &= (1-z)^{-a} F\left(2a, 2c-2a-1; c; \frac{\sqrt{1-z}-1}{2\sqrt{1-z}}\right) \\
 15.3.22 \quad F(a, b; a+b+\frac{1}{2}; z) &= F(2a, 2b; a+b+\frac{1}{2}; \frac{1}{2}-\frac{1}{2}\sqrt{1-z}) \\
 15.3.23 \quad &= \left(\frac{1}{2}+\frac{1}{2}\sqrt{1-z}\right)^{-2a} F\left(2a, a-b+\frac{1}{2}; a+b+\frac{1}{2}; \frac{\sqrt{1-z}-1}{\sqrt{1-z}+1}\right)
 \end{aligned}$$

- 15.3.24  $F(a, b; a+b-\frac{1}{2}; z) = (1-z)^{-1} F(2a-1, 2b-1; a+b-\frac{1}{2}; \frac{1}{2}-\frac{1}{2}\sqrt{1-z})$
- 15.3.25  $= (1-z)^{-1} (\frac{1}{2}+\frac{1}{2}\sqrt{1-z})^{1-2a} F(2a-1, a-b+\frac{1}{2}; a+b-\frac{1}{2}; \frac{\sqrt{1-z}-1}{\sqrt{1-z}+1})$
- 15.3.26  $F(a, b; a-b+1; z) = (1+z)^{-a} F(\frac{1}{2}a, \frac{1}{2}a+\frac{1}{2}; a-b+1; 4z(1+z)^{-2})$
- 15.3.27  $= (1\pm\sqrt{z})^{-2a} F(a, a-b+\frac{1}{2}; 2a-2b+1; \pm 4\sqrt{z}(1\pm\sqrt{z})^{-2})$
- 15.3.28  $= (1-z)^{-a} F(\frac{1}{2}a, \frac{1}{2}a-b+\frac{1}{2}; a-b+1; -4z(1-z)^{-2})$
- 15.3.29  $F(a, b; \frac{1}{2}a+\frac{1}{2}b+\frac{1}{2}; z) = (1-2z)^{-a} F(\frac{1}{2}a, \frac{1}{2}a+\frac{1}{2}; \frac{1}{2}a+\frac{1}{2}b+\frac{1}{2}; \frac{4z^2-4z}{(1-2z)^2})$
- 15.3.30  $= F(\frac{1}{2}a, \frac{1}{2}b; \frac{1}{2}a+\frac{1}{2}b+\frac{1}{2}; 4z-4z^2)$
- 15.3.31  $F(a, 1-a; c; z) = (1-z)^{c-1} F(\frac{1}{2}c-\frac{1}{2}a, \frac{1}{2}c+\frac{1}{2}a-\frac{1}{2}; c; 4z-4z^2)$
- 15.3.32  $= (1-z)^{c-1} (1-2z)^{a-c} F(\frac{1}{2}c-\frac{1}{2}a, \frac{1}{2}c-\frac{1}{2}a+\frac{1}{2}; c; (4z^2-4z)(1-2z)^{-2})$

Cubic transformations are listed in [15.2] and [15.3].

In the formulas above, the square roots are defined so that their value is real and positive when  $0 \leq z < 1$ . All formulas are valid in the neighborhood of  $z=0$ .

### 15.4. Special Cases of $F(a, b; c; z)$

#### Polynomials

When  $a$  or  $b$  is equal to a negative integer, then

$$15.4.1 \quad F(-m, b; c; z) = \sum_{n=0}^m \frac{(-m)_n (b)_n}{(c)_n} \frac{z^n}{n!}$$

This formula is also valid when  $c = -m-l; m, l = 0, 1, 2, \dots$

$$15.4.2 \quad F(-m, b; -m-l; z) = \sum_{n=0}^m \frac{(-m)_n (b)_n}{(-m-l)_n} \frac{z^n}{n!}$$

Some particular cases are

$$15.4.3 \quad F(-n, n; \frac{1}{2}; x) = T_n(1-2x)$$

$$15.4.4 \quad F(-n, n+1; 1; x) = P_n(1-2x)$$

$$15.4.5 \quad F(-n, n+2\alpha; \alpha+\frac{1}{2}; x) = \frac{n!}{(2\alpha)_n} C_n^{(\alpha)}(1-2x)$$

$$15.4.6 \quad F(-n, \alpha+1+\beta+n; \alpha+1; x) = \frac{n!}{(\alpha+1)_n} P_n^{(\alpha, \beta)}(1-2x)$$

Here  $T_n, P_n, C_n^{(\alpha)}, P_n^{(\alpha, \beta)}$  denote Chebyshev, Legendre's, Gegenbauer's and Jacobi's polynomials respectively (see chapter 22).

#### Legendre Functions

Legendre functions are connected with those special cases of the hypergeometric function for which a quadratic transformation exists (see 15.3).

$$15.4.7 \quad F(a, b; 2b; z) = 2^{2b-1} \Gamma(\frac{1}{2}+b) z^{1-b} (1-z)^{b(a-\frac{1}{2})} P_{2b-1}^{a-\frac{1}{2}} \left[ \left(1-\frac{z}{2}\right) (1-z)^{-1} \right]$$

$$15.4.8 \quad = 2^{2b} \pi^{-1} \frac{\Gamma(\frac{1}{2}+b)}{\Gamma(2b-a)} z^{-b} (1-z)^{b(a-\frac{1}{2})} e^{i\pi(a-b)} Q_{b-1}^{a-\frac{1}{2}} \left( \frac{2}{z}-1 \right)^*$$

$$15.4.9 \quad F(a, b; 2b; -z) = 2^{2b} \pi^{-1} \frac{\Gamma(\frac{1}{2}+b)}{\Gamma(a)} z^{-b} (1+z)^{b(a-\frac{1}{2})} e^{-i\pi(a-b)} Q_{b-1}^{a-\frac{1}{2}} \left( 1+\frac{2}{z} \right) (|\arg z| < \pi, |\arg(1\pm z)| < \pi)^*$$

- 15.4.10  $F(a, a + \frac{1}{2}; c; z) = 2^{c-1} \Gamma(c) z^{\frac{1}{2}-ic} (1-z)^{\frac{1}{2}+ic-a} P_{2a-c}^{1-c} [(1-z)^{-\frac{1}{2}}]$   
 $(|\arg z| < \pi, |\arg(1-z)| < \pi, z \text{ not between } 0 \text{ and } -\infty)$
- 15.4.11  $F(a, a + \frac{1}{2}; c; x) = 2^{c-1} \Gamma(c) (-x)^{\frac{1}{2}-ic} (1-x)^{\frac{1}{2}+ic-a} P_{2a-c}^{1-c} [(1-x)^{-\frac{1}{2}}]$   
 $(-\infty < x < 0)$
- 15.4.12  $F(a, b; a+b + \frac{1}{2}; z) = 2^{a+b-1} \Gamma(\frac{1}{2}+a+b) (-z)^{\frac{1}{2}+i(a-b)} P_{a-b-\frac{1}{2}}^{1-a-\frac{1}{2}} [(1-z)^{\frac{1}{2}}]$   
 $(|\arg(-z)| < \pi, z \text{ not between } 0 \text{ and } 1)$
- 15.4.13  $F(a, b; a+b + \frac{1}{2}; x) = 2^{a+b-1} \Gamma(\frac{1}{2}+a+b) x^{\frac{1}{2}+i(a-b)} P_{a-b-\frac{1}{2}}^{1-a-\frac{1}{2}} [(1-x)^{\frac{1}{2}}]$   
 $(0 < x < 1)$
- 15.4.14  $F(a, b; a-b+1; z) = \Gamma(a-b+1) z^{\frac{1}{2}-ia} (1-z)^{-b} P_{-b}^{b-a} \left( \frac{1+z}{1-z} \right)$   
 $(|\arg(1-z)| < \pi, z \text{ not between } 0 \text{ and } -\infty)$
- 15.4.15  $F(a, b; a-b+1; x) = \Gamma(a-b+1) (1-x)^{-b} (-x)^{\frac{1}{2}-ia} P_{-b}^{b-a} \left( \frac{1+x}{1-x} \right)$   
 $(-\infty < x < 0)$
- 15.4.16  $F(a, 1-a; c; z) = \Gamma(c) (-z)^{\frac{1}{2}-ic} (1-z)^{\frac{1}{2}+ic-1} P_{-a}^{1-c} (1-2z)$   
 $(|\arg(-z)| < \pi, |\arg(1-z)| < \pi, z \text{ not between } 0 \text{ and } 1)$
- 15.4.17  $F(a, 1-a; c; x) = \Gamma(c) x^{\frac{1}{2}-ic} (1-x)^{\frac{1}{2}+ic-1} P_{-a}^{1-c} (1-2x)$   
 $(0 < x < 1)$
- 15.4.18  $F(a, b; \frac{1}{2}a + \frac{1}{2}b + \frac{1}{2}; z) = \Gamma(\frac{1}{2} + \frac{1}{2}a + \frac{1}{2}b) [z(z-1)]^{\frac{1}{2}+i(a-b)} P_{\frac{1}{2}(a-b-1)}^{1-a-b} (1-2z)$   
 $(|\arg z| < \pi, |\arg(z-1)| < \pi, z \text{ not between } 0 \text{ and } 1)$
- 15.4.19  $F(a, b; \frac{1}{2}a + \frac{1}{2}b + \frac{1}{2}; x) = \Gamma(\frac{1}{2} + \frac{1}{2}a + \frac{1}{2}b) (x-x^2)^{\frac{1}{2}+i(a-b)} P_{\frac{1}{2}(a-b-1)}^{1-a-b} (1-2x)$   
 $(0 < x < 1)$
- 15.4.20  $F(a, b; a+b-\frac{1}{2}; z) = 2^{a+b-1} \Gamma(a+b-\frac{1}{2}) (-z)^{\frac{1}{2}+i(a-b)} (1-z)^{-1} P_{a-b-\frac{1}{2}}^{1-a-\frac{1}{2}} [(1-z)^{\frac{1}{2}}]$   
 $(|\arg(-z)| < \pi, |\arg(1-z)| < \pi, \Re[(1-z)^{\frac{1}{2}}] > 0, z \text{ not between } 0 \text{ and } 1)$
- 15.4.21  $F(a, b; a+b-\frac{1}{2}; x) = 2^{a+b-1} \Gamma(a+b-\frac{1}{2}) x^{\frac{1}{2}+i(a-b)} (1-x)^{-1} P_{a-b-\frac{1}{2}}^{1-a-\frac{1}{2}} [(1-x)^{\frac{1}{2}}]$   
 $(0 < x < 1)$
- 15.4.22  $F(a, b; \frac{1}{2}; z) = \pi^{-1} 2^{a+b-1} \Gamma(\frac{1}{2}+a) \Gamma(\frac{1}{2}+b) (z-1)^{\frac{1}{2}+i(a-b)} [P_{a-b-\frac{1}{2}}^{1-a-\frac{1}{2}}(z^{\frac{1}{2}}) + P_{a-b-\frac{1}{2}}^{1-a-\frac{1}{2}}(-z^{\frac{1}{2}})]$   
 $(|\arg z| < \pi, |\arg(z-1)| < \pi, z \text{ not between } 0 \text{ and } 1)$
- 15.4.23  $F(a, b; \frac{1}{2}; x) = \pi^{-1} 2^{a+b-1} \Gamma(\frac{1}{2}+a) \Gamma(\frac{1}{2}+b) (1-x)^{\frac{1}{2}+i(a-b)} [P_{a-b-\frac{1}{2}}^{1-a-\frac{1}{2}}(x^{\frac{1}{2}}) + P_{a-b-\frac{1}{2}}^{1-a-\frac{1}{2}}(-x^{\frac{1}{2}})]$   
 $(0 < x < 1)$
- 15.4.24  $F(a, b; \frac{1}{2}; -z) = \pi^{-1} 2^{a+b-1} \Gamma(\frac{1}{2}+a) \Gamma(1-b) (z+1)^{-\frac{1}{2}+ib} e^{\pm i \frac{\pi}{2}(b-a)} \{ P_{a+b-1}^{b-a} [z^{\frac{1}{2}}(1+z)^{-\frac{1}{2}}] + P_{a+b-1}^{b-a} [-z^{\frac{1}{2}}(1+z)^{-\frac{1}{2}}] \}$   
 $(\pm \text{ according as } \Im z \geq 0, z \text{ not between } 0 \text{ and } \infty)$
- 15.4.25  $F(a, b; \frac{1}{2}; -x) = \pi^{-1} 2^{a+b-1} \Gamma(\frac{1}{2}+a) \Gamma(1-b) (1+x)^{-\frac{1}{2}+ib} \{ P_{a+b-1}^{b-a} [x^{\frac{1}{2}}(1+x)^{-\frac{1}{2}}] + P_{a+b-1}^{b-a} [-x^{\frac{1}{2}}(1+x)^{-\frac{1}{2}}] \}$   
 $(0 < x < \infty)$
- 15.4.26  $F(a, b; \frac{3}{2}; x) = -\pi^{-1} 2^{a+b-1} \Gamma(a-\frac{1}{2}) \Gamma(b-\frac{1}{2}) x^{-\frac{1}{2}+i(a-b)} \{ P_{a-b-\frac{1}{2}}^{1-a-\frac{1}{2}}(x^{\frac{1}{2}}) - P_{a-b-\frac{1}{2}}^{1-a-\frac{1}{2}}(-x^{\frac{1}{2}}) \}$   
 $(0 < x < 1)$

### 15.5. The Hypergeometric Differential Equation

The hypergeometric differential equation

$$15.5.1 \quad z(1-z) \frac{d^2 w}{dz^2} + [c - (a+b+1)z] \frac{dw}{dz} - abw = 0$$

\*See page II.

has three (regular) singular points  $z=0, 1, \infty$ . The pairs of exponents at these points are

$$15.5.2 \quad \rho_{1,2}^{(0)}=0, 1-c, \quad \rho_{1,2}^{(1)}=0, c-a-b, \quad \rho_{1,2}^{(\infty)}=a, b$$

respectively. The general theory of differential equations of the Fuchsian type distinguishes between the following cases.

A. None of the numbers  $c, c-a-b; a-b$  is equal to an integer. Then two linearly independent solutions of 15.5.1 in the neighborhood of the singular points  $0, 1, \infty$  are respectively

$$15.5.3 \quad w_{1(0)}=F(a, b; c; z)=(1-z)^{c-a-b}F(c-a, c-b; c; z)$$

$$15.5.4 \quad w_{2(0)}=z^{1-c}F(a-c+1, b-c+1; 2-c; z)=z^{1-c}(1-z)^{c-a-b}F(1-a, 1-b; 2-c; z)$$

$$15.5.5 \quad w_{1(1)}=F(a, b; a+b+1-c; 1-z)=z^{1-c}F(1+b-c, 1+a-c; a+b+1-c; 1-z)$$

$$15.5.6 \quad w_{2(1)}=(1-z)^{c-a-b}F(c-b, c-a; c-a-b+1; 1-z)=z^{1-c}(1-z)^{c-a-b}F(1-a, 1-b; c-a-b+1; 1-z)$$

$$15.5.7 \quad w_{1(\infty)}=z^{-a}F(a, a-c+1; a-b+1; z^{-1})=z^{b-c}(z-1)^{c-a-b}F(1-b, c-b; a-b+1; z^{-1})$$

$$15.5.8 \quad w_{2(\infty)}=z^{-b}F(b, b-c+1; b-a+1; z^{-1})=z^{a-c}(z-1)^{c-a-b}F(1-a, c-a; b-a+1; z^{-1})$$

The second set of the above expressions is obtained by applying 15.3.3 to the first set.

Another set of representations is obtained by applying 15.3.4 to 15.5.3 through 15.5.8. This gives 15.5.9-15.5.14.

$$15.5.9 \quad w_{1(0)}=(1-z)^{-a}F\left(a, c-b; c; \frac{z}{z-1}\right)=(1-z)^{-b}F\left(b, c-a; c; \frac{z}{z-1}\right)$$

$$15.5.10 \quad w_{2(0)}=z^{1-c}(1-z)^{c-a-1}F\left(a-c+1, 1-b; 2-c; \frac{z}{z-1}\right)=z^{1-c}(1-z)^{c-b-1}F\left(b-c+1, 1-a; 2-c; \frac{z}{z-1}\right)$$

$$15.5.11 \quad w_{1(1)}=z^{-a}F(a, a-c+1; a+b-c+1; 1-z^{-1})=z^{-b}F(b, b-c+1; a+b-c+1; 1-z^{-1})$$

15.5.12

$$w_{2(1)}=z^{a-c}(1-z)^{c-a-b}F(c-a, 1-a; c-a-b+1; 1-z^{-1})=z^{b-c}(1-z)^{c-a-b}F(c-b, 1-b; c-a-b+1; 1-z^{-1})$$

$$15.5.13 \quad w_{1(\infty)}=(z-1)^{-a}F\left(a, c-b; a-b+1; \frac{1}{1-z}\right)=(z-1)^{-b}F\left(b, c-a; b-a+1; \frac{1}{1-z}\right)$$

15.5.14

$$w_{2(\infty)}=z^{1-c}(z-1)^{c-a-1}F\left(a-c+1, 1-b; a-b+1; \frac{1}{1-z}\right)=z^{1-c}(z-1)^{c-b-1}F\left(b-c+1, 1-a; b-a+1; \frac{1}{1-z}\right)$$

15.5.3 to 15.5.14 constitute Kummer's 24 solutions of the hypergeometric equation. The analytic continuation of  $w_{1,2(0)}(z)$  can then be obtained by means of 15.3.3 to 15.3.9.

B. One of the numbers  $a, b, c-a, c-b$  is an integer. Then one of the hypergeometric series for instance  $w_{1,2(0)}$ , 15.5.3, 15.5.4 terminates and the corresponding solution is of the form

$$15.5.15 \quad w=z^a(1-z)^b p_n(z)$$

where  $p_n(z)$  is a polynomial in  $z$  of degree  $n$ . This case is referred to as the degenerate case of the hypergeometric differential equation and its solutions are listed and discussed in great detail in [15.2].

C. The number  $c-a-b$  is an integer,  $c$  nonintegral. Then 15.3.10 to 15.3.12 give the analytic continuation of  $w_{1,2(0)}$  into the neighborhood of  $z=1$ . Similarly 15.3.13 and 15.3.14 give the analytic continuation of  $w_{1,2(0)}$  into the neighborhood of  $z=\infty$  in case  $a-b$  is an integer but not  $c$ , subject of course to the further restrictions  $c-a=0, \pm 1, \pm 2 \dots$  (For a detailed discussion of all possible cases, see [15.2]).

D. The number  $c=1$ . Then 15.5.3, 15.5.4 are replaced by

$$15.5.16 \quad w_{1(0)}=F(a, b; 1; z)$$

15.5.17  $w_{2(0)} = F(a, b; 1; z) \ln z + \sum_{n=1}^{\infty} \frac{(a)_n (b)_n}{(n!)^2} z^n [\psi(a+n) - \psi(a) + \psi(b+n) - \psi(b) - 2\psi(n+1) + 2\psi(1)] \quad (|z| < 1)$

E. The number  $c = m + 1, m = 1, 2, 3, \dots$ . A fundamental system is

15.5.18  $w_{1(0)} = F(a, b; m + 1; z)$

15.5.19  $w_{2(0)} = F(a, b; m + 1; z) \ln z + \sum_{n=1}^{\infty} \frac{(a)_n (b)_n}{(1+m)_n n!} z^n [\psi(a+n) - \psi(a) + \psi(b+n) - \psi(b) - \psi(m+1+n) + \psi(m+1) - \psi(n+1) + \psi(1)] - \sum_{n=1}^m \frac{(n-1)! (-m)_n}{(1-a)_n (1-b)_n} z^{-n} \quad (|z| < 1 \text{ and } a, b \neq 0, 1, 2, \dots, (m-1))$

F. The number  $c = 1 - m, m = 1, 2, 3, \dots$ . A fundamental system is

15.5.20  $w_{1(0)} = z^m F(a + m, b + m; 1 + m; z)$

15.5.21

$$w_{2(0)} = z^m F(a + m, b + m; 1 + m; z) \ln z + z^m \sum_{n=1}^{\infty} z^n \frac{(a+m)_n (b+m)_n}{(1+m)_n n!} [\psi(a+m+n) - \psi(a+m) + \psi(b+m+n) - \psi(b+m) - \psi(m+1+n) + \psi(m+1) - \psi(n+1) + \psi(1)] - \sum_{n=1}^m \frac{(n-1)! (-m)_n}{(1-a-m)_n (1-b-m)_n} z^{m-n} \quad (|z| < 1 \text{ and } a, b \neq 0, -1, -2, \dots, -(m-1))$$

15.6. Riemann's Differential Equation

The hypergeometric differential equation 15.5.1 with the (regular) singular points 0, 1,  $\infty$  is a special case of Riemann's differential equation with three (regular) singular points  $a, b, c$

15.6.1

$$\frac{d^2 w}{dz^2} + \left[ \frac{1-\alpha-\alpha'}{z-a} + \frac{1-\beta-\beta'}{z-b} + \frac{1-\gamma-\gamma'}{z-c} \right] \frac{dw}{dz} + \left[ \frac{\alpha\alpha'(a-b)(a-c)}{z-a} + \frac{\beta\beta'(b-c)(b-a)}{z-b} + \frac{\gamma\gamma'(c-a)(c-b)}{z-c} \right] \frac{w}{(z-a)(z-b)(z-c)} = 0$$

The pairs of the exponents with respect to the singular points  $a; b; c$  are  $\alpha, \alpha'; \beta, \beta'; \gamma, \gamma'$  respectively subject to the condition

15.6.2  $\alpha + \alpha' + \beta + \beta' + \gamma + \gamma' = 1$

The complete set of solutions of 15.6.1 is denoted by the symbol

15.6.3  $w = P \left\{ \begin{matrix} a & b & c \\ \alpha & \beta & \gamma \\ \alpha' & \beta' & \gamma' \end{matrix} \right\} z$

Special Cases of Riemann's P Function

(a) The generalized hypergeometric function

15.6.4

$$w = P \left\{ \begin{matrix} 0 & \infty & 1 \\ \alpha & \beta & \gamma \\ \alpha' & \beta' & \gamma' \end{matrix} \right\} z$$

(b) The hypergeometric function  $F(a, b; c; z)$

15.6.5

$$w = P \left\{ \begin{matrix} 0 & \infty & 1 \\ 0 & a & 0 \\ 1-c & b & c-a-b \end{matrix} \right\} z$$

(c) The Legendre functions  $P_\nu^\mu(z), Q_\nu^\mu(z)$

15.6.6

$$w = P \left\{ \begin{matrix} 0 & \infty & 1 \\ -\frac{1}{2}\nu & \frac{1}{2}\mu & 0 \\ \frac{1}{2} + \frac{1}{2}\nu & -\frac{1}{2}\mu & \frac{1}{2} \end{matrix} \right\} (1-z^2)^{-1}$$

(d) The confluent hypergeometric function

15.6.7

$$w = P \left\{ \begin{matrix} 0 & \infty & c \\ \frac{1}{2} + u & -c & c-k \\ \frac{1}{2} - u & 0 & k \end{matrix} \right\} z$$

provided  $\lim c \rightarrow \infty$ .



Transformation Formulas for Riemann's  $P$  Function

$$15.6.8 \quad \left(\frac{z-a}{z-b}\right)^k \left(\frac{z-c}{z-b}\right)^l P \left\{ \begin{matrix} a & b & c \\ \alpha & \beta & \gamma \\ \alpha' & \beta' & \gamma' \end{matrix} \middle| z \right\} = P \left\{ \begin{matrix} a & b & c \\ \alpha+k & \beta-k-l & \gamma+l \\ \alpha'+k & \beta'-k-l & \gamma'+l \end{matrix} \middle| z \right\}$$

$$15.6.9 \quad P \left\{ \begin{matrix} a & b & c \\ \alpha & \beta & \gamma \\ \alpha' & \beta' & \gamma' \end{matrix} \middle| z \right\} = P \left\{ \begin{matrix} a_1 & b_1 & c_1 \\ \alpha & \beta & \gamma \\ \alpha' & \beta' & \gamma' \end{matrix} \middle| z_1 \right\}$$

where

$$15.6.10 \quad z = \frac{Az_1+B}{Cz_1+D}, \quad a = \frac{Aa_1+B}{Ca_1+D}, \quad b = \frac{Ab_1+B}{Cb_1+D}, \quad c = \frac{Ac_1+B}{Cc_1+D}$$

and  $A, B, C, D$  are arbitrary constants such that  $AD-BC \neq 0$ .

Riemann's  $P$  function reduced to the hypergeometric function is

$$15.6.11 \quad P \left\{ \begin{matrix} a & b & c \\ \alpha & \beta & \gamma \\ \alpha' & \beta' & \gamma' \end{matrix} \middle| z \right\} = \left(\frac{z-a}{z-b}\right)^\alpha \left(\frac{z-c}{z-b}\right)^\gamma P \left\{ \begin{matrix} 0 & \infty & 1 \\ 0 & \alpha+\beta+\gamma & 0 \\ \alpha'-\alpha & \alpha+\beta'+\gamma & \gamma'-\gamma \end{matrix} \middle| \frac{(z-a)(c-b)}{(z-b)(c-a)} \right\}$$

The  $P$  function on the right hand side is Gauss' hypergeometric function (see 15.6.5). If it is replaced by Kummer's 24 solutions 15.5.3 to 15.5.14 the complete set of 24 solutions for Riemann's differential equation 15.6.1 is obtained. The first of these solutions is for instance by 15.5.3 and 15.6.5

$$15.6.12 \quad w = \left(\frac{z-a}{z-b}\right)^\alpha \left(\frac{z-c}{z-b}\right)^\gamma F \left[ \alpha+\beta+\gamma, \alpha+\beta'+\gamma; 1+\alpha-\alpha'; \frac{(z-a)(c-b)}{(z-b)(c-a)} \right]$$

15.7. Asymptotic Expansions

The behavior of  $F(a, b; c; z)$  for large  $|z|$  is described by the transformation formulas of 15.3.

For fixed  $a, b, z$  and large  $|c|$  one has [15.8]

15.7.1

$$F(a, b; c; z) = \sum_{n=0}^m \frac{(a)_n (b)_n z^n}{(c)_n n!} + O(|c|^{-m-1})$$

For fixed  $a, c, z, (c \neq 0, -1, -2, \dots, 0 < |z| < 1)$  and large  $|b|$  one has [15.2]

15.7.2

$$F(a, b; c; z) = e^{-i\pi a} [\Gamma(c)/\Gamma(c-a)] (bz)^{-a} [1 + O(|bz|^{-1})] + [\Gamma(c)/\Gamma(a)] e^{b\pi} (bz)^{a-c} [1 + O(|bz|^{-1})] \left( -\frac{3\pi}{2} < \arg(bz) < \frac{1}{2}\pi \right)$$

15.7.3

$$F(a, b; c; z) = e^{i\pi a} [\Gamma(c)/\Gamma(c-a)] (bz)^{-a} [1 + O(|bz|^{-1})] + [\Gamma(c)/\Gamma(a)] e^{b\pi} (bz)^{a-c} [1 + O(|bz|^{-1})] \left( -\frac{1}{2}\pi < \arg(bz) < \frac{3}{2}\pi \right)$$

For the case when more than one of the parameters are large consult [15.2].

References

|   |  |
|---|--|
| <p>[15.1] P. Appell and J. Kampé de Fériet, <i>Fonctions hypergéométriques et hypersphériques</i> (Gauthiers-Villars, Paris, France, 1926).</p> <p>[15.2] A. Erdélyi et al., <i>Higher transcendental functions</i>, vol. 1 (McGraw-Hill Book Co., Inc., New York, N.Y., 1953).</p> <p>[15.3] E. Goursat, <i>Ann. Sci. École Norm. Sup</i>(2)10, 3-142(1881).</p> | <p>[15.4] E. Goursat, <i>Propriétés générales de l'équation d'Euler et de Gauss</i> (Actualités scientifiques et industrielles 333, Paris, France, 1936).</p> <p>[15.5] J. Kampé de Fériet, <i>La fonction hypergéométrique</i> (Gauthiers-Villars, Paris, France, 1937).</p> <p>[15.6] F. Klein, <i>Vorlesungen über die hypergeometrische Funktion</i> (B. G. Teubner, Berlin, Germany, 1933).</p> |
|---|--|

- [15.7] E. E. Kummer, Über die hypergeometrische Reihe, *J. Reine Angew. Math.* **15**, 39–83, 127–172(1836).
- [15.8] T. M. MacRobert, *Proc. Edinburgh Math. Soc.* **42**, 84–88(1923).
- [15.9] T. M. MacRobert, *Functions of a complex variable*, 4th ed. (Macmillan and Co., Ltd., London, England, 1954).
- [15.10] E. G. C. Poole, *Introduction to the theory of linear differential equations* (Clarendon Press, Oxford, England, 1936).
- [15.11] C. Snow, *The hypergeometric and Legendre functions with applications to integral equations of potential theory*, Applied Math. Series 19 (U.S. Government Printing Office, Washington, D.C., 1952).
- [15.12] E. T. Whittaker and G. N. Watson, *A course of modern analysis*, 4th ed. (Cambridge Univ. Press, Cambridge, England, 1952).

# 16. Jacobian Elliptic Functions and Theta Functions

L. M. MILNE-THOMSON<sup>1</sup>

## Contents

|  | Page       |
|--|------------|
| <b>Mathematical Properties . . . . .</b>   | <b>569</b> |
| 16.1. Introduction . . . . .   | 569        |
| 16.2. Classification of the Twelve Jacobian Elliptic Functions . .   | 570        |
| 16.3. Relation of the Jacobian Functions to the Copolar Trio . .   | 570        |
| 16.4. Calculation of the Jacobian Functions by Use of the Arith-<br>metically-Geometric Mean (A.G.M.) . . . . .  | 571        |
| 16.5. Special Arguments . . . . .  | 571        |
| 16.6. Jacobian Functions when $m=0$ or $1$ . . . . .   | 571        |
| 16.7. Principal Terms . . . . .  | 572        |
| 16.8. Change of Argument . . . . .   | 572        |
| 16.9. Relations Between the Squares of the Functions . . . . .   | 573        |
| 16.10. Change of Parameter . . . . .   | 573        |
| 16.11. Reciprocal Parameter (Jacobi's Real Transformation) . . .   | 573        |
| 16.12. Descending Landen Transformation (Gauss' Transforma-<br>tion) . . . . .                                   | 573        |
| 16.13. Approximation in Terms of Circular Functions . . . . .  | 573        |
| 16.14. Ascending Landen Transformation . . . . .   | 573        |
| 16.15. Approximation in Terms of Hyperbolic Functions . . . . .  | 574        |
| 16.16. Derivatives . . . . .   | 574        |
| 16.17. Addition Theorems . . . . .   | 574        |
| 16.18. Double Arguments . . . . .  | 574        |
| 16.19. Half Arguments . . . . .  | 574        |
| 16.20. Jacobi's Imaginary Transformation . . . . .   | 574        |
| 16.21. Complex Arguments . . . . .   | 575        |
| 16.22. Leading Terms of the Series in Ascending Powers of $u$ . .  | 575        |
| 16.23. Series Expansion in Terms of the Nome $q$ . . . . .   | 575        |
| 16.24. Integrals of the Twelve Jacobian Elliptic Functions . . . .   | 575        |
| 16.25. Notation for the Integrals of the Squares of the Twelve<br>Jacobian Elliptic Functions . . . . .          | 576        |
| 16.26. Integrals in Terms of the Elliptic Integral of the Second<br>Kind . . . . .                               | 576        |
| 16.27. Theta Functions; Expansions in Terms of the Nome $q$ . .  | 576        |
| 16.28. Relations Between the Squares of the Theta Functions . .  | 576        |
| 16.29. Logarithmic Derivatives of the Theta Functions . . . . .  | 576        |
| 16.30. Logarithms of Theta Functions of Sum and Difference . .   | 577        |
| 16.31. Jacobi's Notation for Theta Functions . . . . .   | 577        |
| 16.32. Calculation of Jacobi's Theta Function $\Theta(u m)$ by Use of<br>the Arithmetic-Geometric Mean . . . . . | 577        |

<sup>1</sup> University of Arizona. (Prepared under contract with the National Bureau of Standards.)

|   | Page |
|---|------|
| 16.33. Addition of Quarter-Periods to Jacobi's Eta and Theta Functions . . . . .  | 577  |
| 16.34. Relation of Jacobi's Zeta Function to the Theta Functions . . . . .  | 578  |
| 16.35. Calculation of Jacobi's Zeta Function $Z(u m)$ by Use of the Arithmetic-Geometric Mean . . . . .   | 578  |
| 16.36. Neville's Notation for Theta Functions . . . . .   | 578  |
| 16.37. Expression as Infinite Products . . . . .  | 579  |
| 16.38. Expression as Infinite Series . . . . .  | 579  |
| <b>Numerical Methods</b> . . . . .  | 579  |
| 16.39. Use and Extension of the Tables . . . . .  | 579  |
| <b>References</b> . . . . .   | 581  |
| <b>Table 16.1. Theta Functions</b> . . . . .  | 582  |
| $\vartheta_s(\epsilon^\circ \backslash \alpha^\circ), \sqrt{\sec \alpha} \vartheta_c(\epsilon_1^\circ \backslash \alpha^\circ)$<br>$\vartheta_n(\epsilon^\circ \backslash \alpha^\circ), \sqrt{\sec \alpha} \vartheta_d(\epsilon_1^\circ \backslash \alpha^\circ)$<br>$\alpha = 0^\circ(5^\circ)85^\circ, \epsilon, \epsilon_1 = 0^\circ(5^\circ)90^\circ, \quad 9-10D$ |      |

|   |     |
|---|-----|
| <b>Table 16.2. Logarithmic Derivatives of Theta Functions</b> . . . . . | 584 |
|---|-----|

$$\frac{d}{du} \ln \vartheta_s(u) = f(\epsilon^\circ \backslash \alpha^\circ)$$

$$\frac{d}{du} \ln \vartheta_c(u) = -f(\epsilon_1^\circ \backslash \alpha^\circ)$$

$$\frac{d}{du} \ln \vartheta_n(u) = g(\epsilon^\circ \backslash \alpha^\circ)$$

$$\frac{d}{du} \ln \vartheta_d(u) = -g(\epsilon_1^\circ \backslash \alpha^\circ)$$

$$\alpha = 0^\circ(5^\circ)85^\circ, \epsilon, \epsilon_1 = 0^\circ(5^\circ)90^\circ, \quad 5-6D$$

The author wishes to acknowledge his great indebtedness to his friend, the late Professor E. H. Neville, for invaluable assistance in reading and criticizing the manuscript. Professor Neville generously supplied material from his own work and was responsible for many improvements in matter and arrangement.

The author's best thanks are also due to David S. Liepman and Ruth Zucker for the preparation and checking of the tables and graphs.

# 16. Jacobian Elliptic Functions and Theta Functions

## Mathematical Properties

### Jacobian Elliptic Functions

#### 16.1. Introduction

A doubly periodic meromorphic function is called an *elliptic function*.

Let  $m, m_1$  be numbers such that

$$m + m_1 = 1.$$

We call  $m$  the *parameter*,  $m_1$  the *complementary parameter*.

In what follows we shall assume that the parameter  $m$  is a real number. Without loss of generality we can then suppose that  $0 \leq m \leq 1$  (see 16.10, 16.11).

We define *quarter-periods*  $K$  and  $iK'$  by

##### 16.1.1

$$K(m) = K = \int_0^{\pi/2} \frac{d\theta}{(1 - m \sin^2 \theta)^{1/2}},$$

$$iK'(m) = iK' = i \int_0^{\pi/2} \frac{d\theta}{(1 - m_1 \sin^2 \theta)^{1/2}}$$

so that  $K$  and  $K'$  are real numbers.  $K$  is called the real,  $iK'$  the imaginary quarter-period.

We note that

$$16.1.2 \quad K(m) = K'(m_1) = K'(1 - m).$$

We also note that if any *one* of the numbers  $m, m_1, K(m), K'(m), K'(m)/K(m)$  is given, all the rest are determined. Thus  $K$  and  $K'$  can not both be chosen arbitrarily.

In the Argand diagram denote the points  $0, K, K + iK', iK'$  by  $s, c, d, n$  respectively. These points are at the vertices of a rectangle. The translations of this rectangle by  $\lambda K, \mu iK'$ , where  $\lambda, \mu$  are given all integral values positive or negative, will lead to the lattice

|    |    |    |    |
|----|----|----|----|
| .s | .c | .s | .c |
| .n | .d | .n | .d |
| .s | .c | .s | .c |
| .n | .d | .n | .d |

the pattern being repeated indefinitely on all sides.

Let  $p, q$  be any two of the letters  $s, c, d, n$ . Then  $p, q$  determine in the lattice a minimum rectangle whose sides are of length  $K$  and  $K'$  and whose vertices  $s, c, d, n$  are in counterclockwise order.

#### Definition

The Jacobian elliptic function  $pq u$  is defined by the following three properties.

(i)  $pq u$  has a simple zero at  $p$  and a simple pole at  $q$ .

(ii) The step from  $p$  to  $q$  is a half-period of  $pq u$ . Those of the numbers  $K, iK', K + iK'$  which differ from this step are only quarter-periods.

(iii) The coefficient of the leading term in the expansion of  $pq u$  in ascending powers of  $u$  about  $u=0$  is unity. With regard to (iii) the leading term is  $u, 1/u, 1$  according as  $u=0$  is a zero, a pole, or an ordinary point.

Thus the functions with a pole or zero at the origin (i.e., the functions in which one letter is  $s$ ) are odd, and the others are even.

Should we wish to call explicit attention to the value of the parameter, we write  $pq(u|m)$  instead of  $pq u$ .

The Jacobian elliptic functions can also be defined with respect to certain integrals. Thus if

$$16.1.3 \quad u = \int_0^\varphi \frac{d\theta}{(1 - m \sin^2 \theta)^{1/2}},$$

the angle  $\varphi$  is called the *amplitude*

$$16.1.4 \quad \varphi = \text{am } u$$

and we define

##### 16.1.5

$$\text{sn } u = \sin \varphi, \quad \text{cn } u = \cos \varphi,$$

$$\text{dn } u = (1 - m \sin^2 \varphi)^{1/2} = \Delta(\varphi).$$

Similarly all the functions  $pq u$  can be expressed in terms of  $\varphi$ . This second set of definitions, although seemingly different, is mathematically equivalent to the definition previously given in terms of a lattice. For further explanation of notations, including the interpretation, of such expressions as  $\text{sn}(\varphi|\alpha), \text{cn}(u|m), \text{dn}(u, k)$ , see 17.2.

16.2. Classification of the Twelve Jacobian Elliptic Functions

According to Poles and Half-Periods

|                     | Pole $iK'$     | Pole $K+iK'$   | Pole $K$       | Pole $0$       |                             |
|---------------------|----------------|----------------|----------------|----------------|-----------------------------|
| Half period $iK'$   | $\text{sn } u$ | $\text{cd } u$ | $\text{dc } u$ | $\text{ns } u$ | Periods $2iK', 4K+4iK', 4K$ |
| Half period $K+iK'$ | $\text{cn } u$ | $\text{sd } u$ | $\text{nc } u$ | $\text{ds } u$ | Periods $4iK', 2K+2iK', 4K$ |
| Half period $K$     | $\text{dn } u$ | $\text{nd } u$ | $\text{sc } u$ | $\text{cs } u$ | Periods $4iK', 4K+4iK', 2K$ |

The three functions in a vertical column are *copolar*.

The four functions in a horizontal line are *coperiodic*. Of the periods quoted in the last line of each row only two are independent.

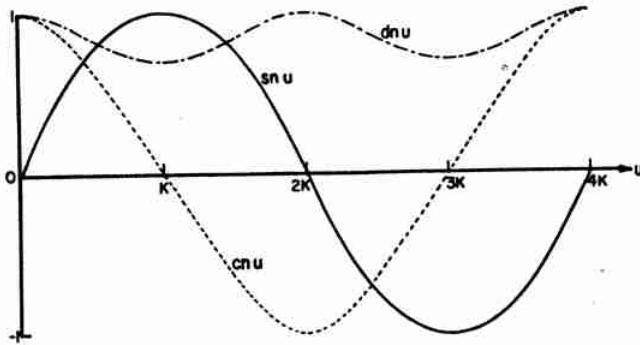

FIGURE 16.1. *Jacobian elliptic functions*

$\text{sn } u, \text{cn } u, \text{dn } u$

$$m = \frac{1}{2}$$

The curve for  $\text{on}(u/\frac{1}{2})$  is the boundary between those which have an inflexion and those which have not.

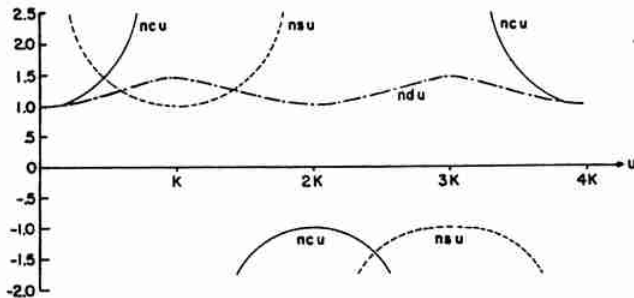

FIGURE 16.2. *Jacobian elliptic functions*

$\text{ns } u, \text{nc } u, \text{nd } u$

$$m = \frac{1}{2}$$

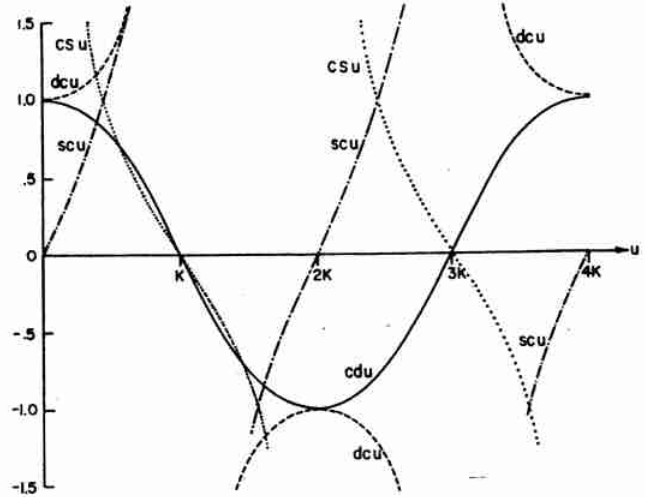

FIGURE 16.3. *Jacobian elliptic functions*

$\text{sc } u, \text{cs } u, \text{cd } u, \text{dc } u$

$$m = \frac{1}{2}$$

16.3. Relation of the Jacobian Functions to the Copolar Trio  $\text{sn } u, \text{cn } u, \text{dn } u$

16.3.1  $\text{cd } u = \frac{\text{cn } u}{\text{dn } u}$      $\text{dc } u = \frac{\text{dn } u}{\text{cn } u}$      $\text{ns } u = \frac{1}{\text{sn } u}$

16.3.2  $\text{sd } u = \frac{\text{sn } u}{\text{dn } u}$      $\text{nc } u = \frac{1}{\text{cn } u}$      $\text{ds } u = \frac{\text{dn } u}{\text{sn } u}$

16.3.3  $\text{nd } u = \frac{1}{\text{dn } u}$      $\text{sc } u = \frac{\text{sn } u}{\text{cn } u}$      $\text{cs } u = \frac{\text{cn } u}{\text{sn } u}$

And generally if  $p, q, r$  are any three of the letters  $s, c, d, n$ ,

16.3.4  $\text{pq } u = \frac{\overline{\text{pr}} u}{\text{qr } u}$

provided that when two letters are the same, e.g.,  $\text{pp } u$ , the corresponding function is put equal to unity.

**16.4. Calculation of the Jacobian Functions by Use of the Arithmetic-Geometric Mean (A.G.M.)**

For the A.G.M. scale see 17.6.

To calculate  $\text{sn}(u|m)$ ,  $\text{cn}(u|m)$ , and  $\text{dn}(u|m)$  form the A.G.M. scale starting with

**16.4.1**  $a_0=1, b_0=\sqrt{m_1}, c_0=\sqrt{m},$

terminating at the step  $N$  when  $c_N$  is negligible to the accuracy required. Find  $\varphi_N$  in degrees where

**16.4.2**  $\varphi_N=2^N a_N u \frac{180^\circ}{\pi}$

and then compute successively  $\varphi_{N-1}, \varphi_{N-2}, \dots, \varphi_1, \varphi_0$  from the recurrence relation

**16.4.3**  $\sin(2\varphi_{n-1}-\varphi_n)=\frac{c_n}{a_n} \sin \varphi_n.$

Then

**16.4.4**

$\text{sn}(u|m)=\sin \varphi_0, \text{cn}(u|m)=\cos \varphi_0$

$\text{dn}(u|m)=\frac{\cos \varphi_0}{\cos(\varphi_1-\varphi_0)}$

From these all the other functions can be determined.

**16.5. Special Arguments**

|               | $u$                  | $\text{sn } u$   | $\text{cn } u$                                       | $\text{dn } u$   |
|---------------|----------------------|--|--|--|
| <b>16.5.1</b> | 0                    | 0  | 1  | 1  |
| <b>16.5.2</b> | $\frac{1}{2}K$       | $\frac{1}{(1+m_1^{1/2})^{1/2}}$                              | $\frac{m_1^{1/4}}{(1+m_1^{1/2})^{1/2}}$              | $m_1^{1/4}$  |
| <b>16.5.3</b> | $K$                  | 1  | 0  | $m_1^{1/2}$  |
| <b>16.5.4</b> | $\frac{1}{2}(iK')$   | $im^{-1/4}$  | $\frac{(1+m_1^{1/2})^{1/2}}{m^{1/4}}$                | $(1+m_1^{1/2})^{1/2}$  |
| <b>16.5.5</b> | $\frac{1}{2}(K+iK')$ | $2^{-1/2}m^{-1/4}[(1+m_1^{1/2})^{1/2}+i(1-m_1^{1/2})^{1/2}]$ | $\left(\frac{m_1}{4m}\right)^{1/4}(1-i)$             | $\left(\frac{m_1}{4}\right)^{1/4}[(1+m_1^{1/2})^{1/2}-i(1-m_1^{1/2})^{1/2}]$ |
| <b>16.5.6</b> | $K+\frac{1}{2}(iK')$ | $m^{-1/4}$   | $-i\left(\frac{1-m_1^{1/2}}{m_1^{1/2}}\right)^{1/2}$ | $(1-m_1^{1/2})^{1/2}$  |
| <b>16.5.7</b> | $iK'$                | $\infty$   | $\infty$   | $\infty$   |
| <b>16.5.8</b> | $\frac{1}{2}K+iK'$   | $(1-m_1^{1/2})^{-1/2}$                                       | $-i\left(\frac{m_1^{1/2}}{1-m_1^{1/2}}\right)^{1/2}$ | $-im_1^{1/4}$  |
| <b>16.5.9</b> | $K+iK'$              | $m^{-1/2}$   | $-i(m_1/m)^{1/2}$                                    | 0  |

**16.6. Jacobian Functions when  $m=0$  or 1**

|                |                  | $m=0$    | $m=1$            |
|----------------|------------------|----------|------------------|
| <b>16.6.1</b>  | $\text{sn}(u m)$ | $\sin u$ | $\tanh u$        |
| <b>16.6.2</b>  | $\text{cn}(u m)$ | $\cos u$ | $\text{sech } u$ |
| <b>16.6.3</b>  | $\text{dn}(u m)$ | 1        | $\text{sech } u$ |
| <b>16.6.4</b>  | $\text{cd}(u m)$ | $\cos u$ | 1                |
| <b>16.6.5</b>  | $\text{sd}(u m)$ | $\sin u$ | $\sinh u$        |
| <b>16.6.6</b>  | $\text{nd}(u m)$ | 1        | $\cosh u$        |
| <b>16.6.7</b>  | $\text{dc}(u m)$ | $\sec u$ | 1                |
| <b>16.6.8</b>  | $\text{nc}(u m)$ | $\sec u$ | $\cosh u$        |
| <b>16.6.9</b>  | $\text{sc}(u m)$ | $\tan u$ | $\sinh u$        |
| <b>16.6.10</b> | $\text{ns}(u m)$ | $\csc u$ | $\coth u$        |
| <b>16.6.11</b> | $\text{ds}(u m)$ | $\csc u$ | $\text{csch } u$ |
| <b>16.6.12</b> | $\text{cs}(u m)$ | $\cot u$ | $\text{csch } u$ |
| <b>16.6.13</b> | $\text{am}(u m)$ | $u$      | $\text{gd } u$   |

\*See page II



16.7. Principal Terms

When the elliptic function  $pq u$  is expanded in ascending powers of  $(u - K_r)$ , where  $K_r$  is one of  $0, K, iK', K + iK'$ , the first term of the expansion is called the principal term and has one of the forms  $A, B \times (u - K_r), C \div (u - K_r)$  according as  $K_r$  is an ordinary point, a zero, or a pole of  $pq u$ . The following list gives these forms, where  $\times$  means that the factor  $(u - K_r)$  has to be supplied and  $\div$  means that the divisor  $(u - K_r)$  has to be supplied.

|         | $K_r =$ | 0          | $K$                 | $iK'$             | $K + iK'$                             |
|---------|---------|------------|---------------------|-------------------|---------------------------------------|
| 16.7.1  | sn $u$  | $1 \times$ | 1                   | $m^{-1/2} \div$   | $m^{-1/2}$                            |
| 16.7.2  | cn $u$  | 1          | $-m_1^{1/2} \times$ | $-im^{-1/2} \div$ | $-i \left(\frac{m_1}{m}\right)^{1/2}$ |
| 16.7.3  | dn $u$  | 1          | $m_1^{1/2}$         | $-i \div$         | $im_1^{1/2} \times$                   |
| 16.7.4  | cd $u$  | 1          | $-1 \times$         | $m^{-1/2}$        | $-m^{-1/2} \div$                      |
| 16.7.5  | sd $u$  | $1 \times$ | $m_1^{-1/2}$        | $im^{-1/2}$       | $-\frac{1}{(mm_1)^{1/2}} \div$        |
| 16.7.6  | nd $u$  | 1          | $m_1^{-1/2}$        | $i \times$        | $-im_1^{-1/2} \div$                   |
| 16.7.7  | dc $u$  | 1          | $-1 \div$           | $m^{1/2}$         | $-m^{1/2} \times$                     |
| 16.7.8  | nc $u$  | 1          | $-m_1^{-1/2} \div$  | $im^{1/2} \times$ | $i \left(\frac{m}{m_1}\right)^{1/2}$  |
| 16.7.9  | sc $u$  | $1 \times$ | $-m_1^{-1/2} \div$  | $i$               | $im_1^{-1/2}$                         |
| 16.7.10 | ns $u$  | $1 \div$   | 1                   | $m^{1/2} \times$  | $m^{1/2}$                             |
| 16.7.11 | ds $u$  | $1 \div$   | $m_1^{1/2}$         | $-im^{1/2}$       | $i(mm_1)^{1/2} \times$                |
| 16.7.12 | cs $u$  | $1 \div$   | $-m_1^{1/2} \times$ | $-i$              | $-im_1^{1/2}$                         |

16.8. Change of Argument

|         |    | $u$    | $-u$    | $u + K$           | $u - K$           | $K - u$          | $u + 2K$ | $u - 2K$ | $2K - u$ | $u + iK'$        | $u + 2iK'$ | $u + K + iK'$              | $u + 2K + 2iK'$ |
|---------|----|--------|---------|-------------------|-------------------|------------------|----------|----------|----------|------------------|------------|----------------------------|-----------------|
| 16.8.1  | sn | sn $u$ | $-sn u$ | cd $u$            | $-cd u$           | cd $u$           | $-sn u$  | $-sn u$  | sn $u$   | $m^{-1/2}ns u$   | sn $u$     | $m^{-1/2}dc u$             | $-sn u$         |
| 16.8.2  | cn | cn $u$ | cn $u$  | $-m_1^{1/2}sd u$  | $m_1^{1/2}sd u$   | $m_1^{1/2}sd u$  | $-cn u$  | $-cn u$  | $-cn u$  | $-im^{-1/2}ds u$ | $-cn u$    | $-im_1^{1/2}m^{-1/2}nc u$  | cn $u$          |
| 16.8.3  | dn | dn $u$ | dn $u$  | $m_1^{1/2}nd u$   | $m_1^{1/2}nd u$   | $m_1^{1/2}nd u$  | dn $u$   | dn $u$   | dn $u$   | $-ics u$         | $-dn u$    | $im_1^{1/2}sc u$           | $-dn u$         |
| 16.8.4  | cd | cd $u$ | cd $u$  | $-sn u$           | sn $u$            | sn $u$           | $-cd u$  | $-cd u$  | $-cd u$  | $m^{-1/2}dc u$   | cd $u$     | $-m^{-1/2}ns u$            | $-cd u$         |
| 16.8.5  | sd | sd $u$ | $-sd u$ | $m_1^{-1/2}cn u$  | $-m_1^{-1/2}cn u$ | $m_1^{-1/2}cn u$ | $-sd u$  | $-sd u$  | sd $u$   | $im^{-1/2}nc u$  | $-sd u$    | $-im_1^{-1/2}m^{-1/2}ds u$ | sd $u$          |
| 16.8.6  | nd | nd $u$ | nd $u$  | $m_1^{-1/2}dn u$  | $m_1^{-1/2}dn u$  | $m_1^{-1/2}dn u$ | nd $u$   | nd $u$   | nd $u$   | isc $u$          | $-nd u$    | $-im_1^{-1/2}cs u$         | $-nd u$         |
| 16.8.7  | dc | dc $u$ | dc $u$  | $-ns u$           | ns $u$            | ns $u$           | $-dc u$  | $-dc u$  | $-dc u$  | $m^{1/2}cd u$    | dc $u$     | $-m^{1/2}sn u$             | $-dc u$         |
| 16.8.8  | nc | nc $u$ | nc $u$  | $-m_1^{-1/2}ds u$ | $m_1^{-1/2}ds u$  | $m_1^{-1/2}ds u$ | $-nc u$  | $-nc u$  | $-nc u$  | $im^{1/2}sd u$   | $-nc u$    | $im_1^{-1/2}m^{1/2}cn u$   | nc $u$          |
| 16.8.9  | sc | sc $u$ | $-sc u$ | $-m_1^{-1/2}cs u$ | $-m_1^{-1/2}cs u$ | $m_1^{-1/2}cs u$ | sc $u$   | sc $u$   | $-sc u$  | ind $u$          | $-sc u$    | $im_1^{-1/2}dn u$          | $-sc u$         |
| 16.8.10 | ns | ns $u$ | $-ns u$ | dc $u$            | $-dc u$           | dc $u$           | $-ns u$  | $-ns u$  | ns $u$   | $m^{1/2}sn u$    | ns $u$     | $m^{1/2}cd u$              | $-ns u$         |
| 16.8.11 | ds | ds $u$ | $-ds u$ | $m_1^{1/2}nc u$   | $-m_1^{1/2}nc u$  | $m_1^{1/2}nc u$  | $-ds u$  | $-ds u$  | ds $u$   | $-im^{1/2}cn u$  | $-ds u$    | $im_1^{1/2}m^{1/2}sd u$    | ds $u$          |
| 16.8.12 | cs | cs $u$ | $-cs u$ | $-m_1^{1/2}sc u$  | $-m_1^{1/2}sc u$  | $m_1^{1/2}sc u$  | cs $u$   | cs $u$   | $-cs u$  | $-idn u$         | $-cs u$    | $-im_1^{1/2}nd u$          | $-cs u$         |

**16.9. Relations Between the Squares of the Functions**

16.9.1  $-\text{dn}^2 u + m_1 = -m \text{cn}^2 u = m \text{sn}^2 u - m$

16.9.2  $-m_1 \text{nd}^2 u + m_1 = -m m_1 \text{sd}^2 u = m \text{cd}^2 u - m$

16.9.3  $m_1 \text{sc}^2 u + m_1 = m_1 \text{nc}^2 u = \text{dc}^2 u - m$

16.9.4  $\text{cs}^2 u + m_1 = \text{ds}^2 u = \text{ns}^2 u - m$

In using the above results remember that  $m + m_1 = 1$ .

If  $pq u, rt u$  are any two of the twelve functions, one entry expresses  $tq^2 u$  in terms of  $pq^2 u$  and another expresses  $qt^2 u$  in terms of  $rt^2 u$ . Since  $tq^2 u \cdot qt^2 u = 1$ , we can obtain from the table the bilinear relation between  $pq^2 u$  and  $rt^2 u$ . Thus for the functions  $cd u, sn u$  we have

16.9.5  $\text{nd}^2 u = \frac{1 - m \text{cd}^2 u}{m_1}, \text{dn}^2 u = 1 - m \text{sn}^2 u$

and therefore

16.9.6  $(1 - m \text{cd}^2 u)(1 - m \text{sn}^2 u) = m_1$ .

**16.10. Change of Parameter**

**Negative Parameter**

If  $m$  is a positive number, let

16.10.1  $\mu = \frac{m}{1+m}, \mu_1 = \frac{1}{1+m}, v = \frac{u}{\mu_1^{\frac{1}{2}}}$  ( $0 < \mu < 1$ )

16.10.2  $\text{sn}(u|-m) = \mu_1^{\frac{1}{2}} \text{sd}(v|\mu)$

16.10.3  $\text{cn}(u|-m) = \text{cd}(v|\mu)$

16.10.4  $\text{dn}(u|-m) = \text{nd}(v|\mu)$ .

**16.11. Reciprocal Parameter (Jacobi's Real Transformation)**

16.11.1  $m > 0, \mu = m^{-1}, v = um^{1/2}$

16.11.2  $\text{sn}(u|m) = \mu^{1/2} \text{sn}(v|\mu)$

16.11.3  $\text{cn}(u|m) = \text{dn}(v|\mu)$

16.11.4  $\text{dn}(u|m) = \text{cn}(v|\mu)$

Here if  $m > 1$  then  $m^{-1} = \mu < 1$ .

Thus elliptic functions whose parameter is real can be made to depend on elliptic functions whose parameter lies between 0 and 1.

**16.12. Descending Landen Transformation (Gauss' Transformation)**

To decrease the parameter, let

16.12.1  $\mu = \left(\frac{1 - m_1^{1/2}}{1 + m_1^{1/2}}\right)^2, v = \frac{u}{1 + \mu^{1/2}}$ ,

then

16.12.2  $\text{sn}(u|m) = \frac{(1 + \mu^{1/2}) \text{sn}(v|\mu)}{1 + \mu^{1/2} \text{sn}^2(v|\mu)}$

16.12.3  $\text{cn}(u|m) = \frac{\text{cn}(v|\mu) \text{dn}(v|\mu)}{1 + \mu^{1/2} \text{sn}^2(v|\mu)}$

16.12.4  $\text{dn}(u|m) = \frac{\text{dn}^2(v|\mu) - (1 - \mu^{1/2})}{(1 + \mu^{1/2}) - \text{dn}^2(v|\mu)}$ .

Note that successive applications can be made conveniently to find  $\text{sn}(u|m)$  in terms of  $\text{sn}(v|\mu)$  and  $\text{dn}(u|m)$  in terms of  $\text{dn}(v|\mu)$ , but that the calculation of  $\text{cn}(u|m)$  requires all three functions.

**16.13. Approximation in Terms of Circular Functions**

When the parameter  $m$  is so small that we may neglect  $m^2$  and higher powers, we have the approximations

16.13.1  $\text{sn}(u|m) \approx \sin u - \frac{1}{4} m(u - \sin u \cos u) \cos u$

16.13.2  $\text{cn}(u|m) \approx \cos u + \frac{1}{4} m(u - \sin u \cos u) \sin u$

16.13.3  $\text{dn}(u|m) \approx 1 - \frac{1}{2} m \sin^2 u$

16.13.4  $\text{am}(u|m) \approx u - \frac{1}{4} m(u - \sin u \cos u)$ .

One way of calculating the Jacobian functions is to use Landen's descending transformation to reduce the parameter sufficiently for the above formulae to become applicable. See also 16.14.

**16.14. Ascending Landen Transformation**

To increase the parameter, let

16.14.1  $\mu = \frac{4m^{1/2}}{(1 + m^{1/2})^2}, \mu_1 = \left(\frac{1 - m^{1/2}}{1 + m^{1/2}}\right)^2, v = \frac{u}{1 + \mu_1^{1/2}}$

16.14.2  $\text{sn}(u|m) = (1 + \mu_1^{1/2}) \frac{\text{sn}(v|\mu) \text{cn}(v|\mu)}{\text{dn}(v|\mu)}$

16.14.3  $\text{cn}(u|m) = \frac{1 + \mu_1^{1/2}}{\mu} \frac{\text{dn}^2(v|\mu) - \mu_1^{1/2}}{\text{dn}(v|\mu)}$

16.14.4  $\text{dn}(u|m) = \frac{1 - \mu_1^{1/2}}{\mu} \frac{\text{dn}^2(v|\mu) + \mu_1^{1/2}}{\text{dn}(v|\mu)}$

Note that, when successive applications are to be made, it is simplest to calculate  $\text{dn}(u|m)$  since this is expressed always in terms of the same function. The calculation of  $\text{cn}(u|m)$  leads to that of  $\text{dn}(v|\mu)$ .

The calculation of  $\text{sn}(u|m)$  necessitates the evaluation of all three functions.

**16.15. Approximation in Terms of Hyperbolic Functions**

When the parameter  $m$  is so close to unity that  $m_1^2$  and higher powers of  $m_1$  can be neglected we have the approximations

**16.15.1**

$$\text{sn}(u|m) \approx \tanh u + \frac{1}{4} m_1 (\sinh u \cosh u - u) \text{sech}^2 u$$

**16.15.2**

$$\text{cn}(u|m) \approx \text{sech } u - \frac{1}{4} m_1 (\sinh u \cosh u - u) \tanh u \text{sech } u$$

**16.15.3**

$$\text{dn}(u|m) \approx \text{sech } u + \frac{1}{4} m_1 (\sinh u \cosh u + u) \tanh u \text{sech } u$$

**16.15.4**

$$\text{am}(u|m) \approx \text{gd } u + \frac{1}{4} m_1 (\sinh u \cosh u - u) \text{sech } u.$$

Another way of calculating the Jacobian functions is to use Landen's ascending transformation to increase the parameter sufficiently for the above formulae to become applicable. See also 16.13.

**16.16. Derivatives**

|                 | Function       | Derivative                         |        |
|-----------------|----------------|------------------------------------|--------|
| <b>16.16.1</b>  | $\text{sn } u$ | $\text{cn } u \text{ dn } u$       | Pole n |
| <b>16.16.2</b>  | $\text{cn } u$ | $-\text{sn } u \text{ dn } u$      |        |
| <b>16.16.3</b>  | $\text{dn } u$ | $-m \text{ sn } u \text{ cn } u$   |        |
| <b>16.16.4</b>  | $\text{cd } u$ | $-m_1 \text{ sd } u \text{ nd } u$ | Pole d |
| <b>16.16.5</b>  | $\text{sd } u$ | $\text{cd } u \text{ nd } u$       |        |
| <b>16.16.6</b>  | $\text{nd } u$ | $m \text{ sd } u \text{ cd } u$    |        |
| <b>16.16.7</b>  | $\text{dc } u$ | $m_1 \text{ sc } u \text{ nc } u$  | Pole c |
| <b>16.16.8</b>  | $\text{nc } u$ | $\text{sc } u \text{ dc } u$       |        |
| <b>16.16.9</b>  | $\text{sc } u$ | $\text{dc } u \text{ nc } u$       |        |
| <b>16.16.10</b> | $\text{ns } u$ | $-\text{ds } u \text{ cs } u$      | Pole s |
| <b>16.16.11</b> | $\text{ds } u$ | $-\text{cs } u \text{ ns } u$      |        |
| <b>16.16.12</b> | $\text{cs } u$ | $-\text{ns } u \text{ ds } u$      |        |

Note that the derivative is proportional to the product of the two copolar functions.

**16.17. Addition Theorems**

**16.17.1**  $\text{sn}(u+v)$

$$= \frac{\text{sn } u \cdot \text{cn } v \cdot \text{dn } v + \text{sn } v \cdot \text{cn } u \cdot \text{dn } u}{1 - m \text{ sn}^2 u \cdot \text{sn}^2 v}$$

**16.17.2**  $\text{cn}(u+v)$

$$= \frac{\text{cn } u \cdot \text{cn } v - \text{sn } u \cdot \text{dn } u \cdot \text{sn } v \cdot \text{dn } v}{1 - m \text{ sn}^2 u \cdot \text{sn}^2 v}$$

**16.17.3**  $\text{dn}(u+v) = \frac{\text{dn } u \cdot \text{dn } v - m \text{ sn } u \cdot \text{cn } u \cdot \text{sn } v \cdot \text{cn } v}{1 - m \text{ sn}^2 u \cdot \text{sn}^2 v}$

Addition theorems are derivable one from another and are expressible in a great variety of forms. Thus  $\text{ns}(u+v)$  comes from  $1/\text{sn}(u+v)$  in the form  $(1 - m \text{ sn}^2 u \text{ sn}^2 v) / (\text{sn } u \text{ cn } v \text{ dn } v + \text{sn } v \text{ cn } u \text{ dn } u)$  from 16.17.1.

Alternatively  $\text{ns}(u+v) = m^{1/2} \text{sn} \{ (iK' - u) - v \}$  which again from 16.17.1 yields the form  $(\text{ns } u \text{ cs } v \text{ ds } u - \text{ns } v \text{ cs } u \text{ ds } v) / (\text{ns}^2 u - \text{ns}^2 v)$ .

The function  $\text{pq}(u+v)$  is a rational function of the four functions  $\text{pq } u, \text{pq } v, \text{pq}'u, \text{pq}'v$ .

**16.18. Double Arguments**

**16.18.1**  $\text{sn } 2u$

$$= \frac{2 \text{sn } u \cdot \text{cn } u \cdot \text{dn } u}{1 - m \text{ sn}^4 u} = \frac{2 \text{sn } u \cdot \text{cn } u \cdot \text{dn } u}{\text{cn}^2 u + \text{sn}^2 u \cdot \text{dn}^2 u}$$

**16.18.2**  $\text{cn } 2u$

$$= \frac{\text{cn}^2 u - \text{sn}^2 u \cdot \text{dn}^2 u}{1 - m \text{ sn}^4 u} = \frac{\text{cn}^2 u - \text{sn}^2 u \cdot \text{dn}^2 u}{\text{cn}^2 u + \text{sn}^2 u \cdot \text{dn}^2 u}$$

**16.18.3**  $\text{dn } 2u$

$$= \frac{\text{dn}^2 u - m \text{ sn}^2 u \cdot \text{cn}^2 u}{1 - m \text{ sn}^4 u} = \frac{\text{dn}^2 u + \text{cn}^2 u (\text{dn}^2 u - 1)}{\text{dn}^2 u - \text{cn}^2 u (\text{dn}^2 u - 1)}$$

**16.18.4**  $\frac{1 - \text{cn } 2u}{1 + \text{cn } 2u} = \frac{\text{sn}^2 u \cdot \text{dn}^2 u}{\text{cn}^2 u}$

**16.18.5**  $\frac{1 - \text{dn } 2u}{1 + \text{dn } 2u} = \frac{m \text{ sn}^2 u \cdot \text{cn}^2 u}{\text{dn}^2 u}$

**16.19. Half Arguments**

**16.19.1**  $\text{sn}^2 \frac{1}{2} u = \frac{1 - \text{cn } u}{1 + \text{dn } u}$

**16.19.2**  $\text{cn}^2 \frac{1}{2} u = \frac{\text{dn } u + \text{cn } u}{1 + \text{dn } u}$

**16.19.3**  $\text{dn}^2 \frac{1}{2} u = \frac{m_1 + \text{dn } u + m \text{ cn } u}{1 + \text{dn } u}$

**16.20. Jacobi's Imaginary Transformation**

**16.20.1**  $\text{sn}(iu|m) = i \text{sc}(u|m_1)$

**16.20.2**  $\text{cn}(iu|m) = \text{nc}(u|m_1)$

**16.20.3**  $\text{dn}(iu|m) = \text{dc}(u|m_1)$

16.21. Complex Arguments

With the abbreviations

16.21.1

$$s = \operatorname{sn}(x|m), c = \operatorname{cn}(x|m), d = \operatorname{dn}(x|m), s_1 = \operatorname{sn}(y|m_1), \\ c_1 = \operatorname{cn}(y|m_1), d_1 = \operatorname{dn}(y|m_1)$$

16.21.2  $\operatorname{sn}(x+iy|m) = \frac{s \cdot d_1 + ic \cdot d \cdot s_1 \cdot c_1}{c_1^2 + ms^2 \cdot s_1^2}$

16.21.3  $\operatorname{cn}(x+iy|m) = \frac{c \cdot c_1 - is \cdot d \cdot s_1 \cdot d_1}{c_1^2 + ms^2 \cdot s_1^2}$

16.21.4  $\operatorname{dn}(x+iy|m) = \frac{d \cdot c_1 \cdot d_1 - ims \cdot c \cdot s_1}{c_1^2 + ms^2 \cdot s_1^2}$

16.22. Leading Terms of the Series in Ascending Powers of  $u$

16.22.1

$$\operatorname{sn}(u|m) = u - (1+m) \frac{u^3}{3!} + (1+14m+m^2) \frac{u^5}{5!} \\ - (1+135m+135m^2+m^3) \frac{u^7}{7!} + \dots$$

16.22.2

$$\operatorname{cn}(u|m) = 1 - \frac{u^2}{2!} + (1+4m) \frac{u^4}{4!} \\ - (1+44m+16m^2) \frac{u^6}{6!} + \dots$$

16.22.3

$$\operatorname{dn}(u|m) = 1 - m \frac{u^2}{2!} + m(4+m) \frac{u^4}{4!} \\ - m(16+44m+m^2) \frac{u^6}{6!} + \dots$$

No formulae are known for the general coefficients in these series.

16.23. Series Expansions in Terms of the Nome  $q = e^{-\pi K'/K}$  and the Argument  $v = \pi u/(2K)$

16.23.1  $\operatorname{sn}(u|m) = \frac{2\pi}{m^{1/2}K} \sum_{n=0}^{\infty} \frac{q^{n+1/2}}{1-q^{2n+1}} \sin(2n+1)v$

16.23.2  $\operatorname{cn}(u|m) = \frac{2\pi}{m^{1/2}K} \sum_{n=0}^{\infty} \frac{q^{n+1/2}}{1+q^{2n+1}} \cos(2n+1)v$

16.23.3  $\operatorname{dn}(u|m) = \frac{\pi}{2K} + \frac{2\pi}{K} \sum_{n=1}^{\infty} \frac{q^n}{1+q^{2n}} \cos 2nv$

16.23.4

$$\operatorname{cd}(u|m) = \frac{2\pi}{m^{1/2}K} \sum_{n=0}^{\infty} \frac{(-1)^n q^{n+1/2}}{1-q^{2n+1}} \cos(2n+1)v$$

16.23.5

$$\operatorname{sd}(u|m) = \frac{2\pi}{(mm_1)^{1/2}K} \sum_{n=0}^{\infty} (-1)^n \frac{q^{n+1/2}}{1+q^{2n+1}} \sin(2n+1)v$$

16.23.6

$$\operatorname{nd}(u|m) = \frac{\pi}{2m_1^{1/2}K} + \frac{2\pi}{m_1^{1/2}K} \sum_{n=1}^{\infty} (-1)^n \frac{q^n}{1+q^{2n}} \cos 2nv$$

16.23.7

$$\operatorname{dc}(u|m) = \frac{\pi}{2K} \sec v \\ + \frac{2\pi}{K} \sum_{n=0}^{\infty} (-1)^n \frac{q^{2n+1}}{1-q^{2n+1}} \cos(2n+1)v$$

16.23.8

$$\operatorname{nc}(u|m) = \frac{\pi}{2m_1^{1/2}K} \sec v \\ - \frac{2\pi}{m_1^{1/2}K} \sum_{n=0}^{\infty} (-1)^n \frac{q^{2n+1}}{1+q^{2n+1}} \cos(2n+1)v$$

16.23.9

$$\operatorname{sc}(u|m) = \frac{\pi}{2m_1^{1/2}K} \tan v \\ + \frac{2\pi}{m_1^{1/2}K} \sum_{n=1}^{\infty} (-1)^n \frac{q^{2n}}{1+q^{2n}} \sin 2nv$$

16.23.10

$$\operatorname{ns}(u|m) = \frac{\pi}{2K} \csc v - \frac{2\pi}{K} \sum_{n=0}^{\infty} \frac{q^{2n+1}}{1-q^{2n+1}} \sin(2n+1)v$$

16.23.11

$$\operatorname{ds}(u|m) = \frac{\pi}{2K} \csc v - \frac{2\pi}{K} \sum_{n=0}^{\infty} \frac{q^{2n+1}}{1+q^{2n+1}} \sin(2n+1)v$$

16.23.12

$$\operatorname{cs}(u|m) = \frac{\pi}{2K} \cot v - \frac{2\pi}{K} \sum_{n=1}^{\infty} \frac{q^{2n}}{1+q^{2n}} \sin 2nv$$

16.24. Integrals of the Twelve Jacobian Elliptic Functions

16.24.1  $\int \operatorname{sn} u \, du = m^{-1/2} \ln(\operatorname{dn} u - m^{1/2} \operatorname{cn} u)$

16.24.2  $\int \operatorname{cn} u \, du = m^{-1/2} \arccos(\operatorname{dn} u)$

16.24.3  $\int \operatorname{dn} u \, du = \arcsin(\operatorname{sn} u)$

16.24.4  $\int \operatorname{cd} u \, du = m^{-1/2} \ln(\operatorname{nd} u + m^{1/2} \operatorname{sd} u)$

16.24.5  $\int \operatorname{sd} u \, du = (mm_1)^{-1/2} \arcsin(-m^{1/2} \operatorname{cd} u)$

16.24.6  $\int \operatorname{nd} u \, du = m_1^{-1/2} \arccos(\operatorname{cd} u)$

16.24.7  $\int \operatorname{dc} u \, du = \ln(\operatorname{nc} u + \operatorname{sc} u)$

16.24.8  $\int \operatorname{nc} u \, du = m_1^{-1/2} \ln(\operatorname{dc} u + m_1^{1/2} \operatorname{sc} u)$

16.24.9  $\int \operatorname{sc} u \, du = m_1^{-1/2} \ln(\operatorname{dc} u + m_1^{1/2} \operatorname{nc} u)$

16.24.10  $\int \operatorname{ns} u \, du = \ln(\operatorname{ds} u - \operatorname{cs} u)$

16.24.11  $\int \operatorname{ds} u \, du = \ln(\operatorname{ns} u - \operatorname{cs} u)$

16.24.12  $\int \operatorname{cs} u \, du = \ln(\operatorname{ns} u - \operatorname{ds} u)$

In numerical use of the above table certain restrictions must be put on  $u$  in order to keep the arguments of the logarithms positive and to avoid

trouble with many-valued inverse circular functions.

### 16.25. Notation for the Integrals of the Squares of the Twelve Jacobian Elliptic Functions

$$16.25.1 \quad Pq u = \int_0^u pq^2 t dt \text{ when } q \neq s$$

$$16.25.2 \quad Ps u = \int_0^u \left( pq^2 t - \frac{1}{t^2} \right) dt - \frac{1}{u}$$

Examples

$$Cd u = \int_0^u cd^2 t dt, Ns u = \int_0^u \left( ns^2 t - \frac{1}{t^2} \right) dt - \frac{1}{u}$$

### 16.26. Integrals in Terms of the Elliptic Integral of the Second Kind (see 17.4)

$$16.26.1 \quad mSn u = -E(u) + u$$

$$16.26.2 \quad mCn u = E(u) - m_1 u \quad \text{Pole } n$$

$$16.26.3 \quad Dn u = E(u)$$

$$16.26.4 \quad mCd u = -E(u) + u + msn u cd u$$

#### 16.26.5

$$mm_1Sd u = E(u) - m_1 u - msn u cd u \quad \text{Pole } d$$

$$16.26.6 \quad m_1Nd u = E(u) - msn u cd u$$

$$16.26.7 \quad Dc u = -E(u) + u + sn u dc u$$

#### 16.26.8

$$m_1Nc u = -E(u) + m_1 u + sn u dc u \quad \text{Pole } c$$

$$16.26.9 \quad m_1Sc u = -E(u) + sn u dc u$$

$$16.26.10 \quad Ns u = -E(u) + u - cn u ds u$$

#### 16.26.11

$$Ds u = -E(u) + m_1 u - cn u ds u \quad \text{Pole } s$$

$$16.26.12 \quad Cs u = -E(u) - cn u ds u$$

All the above may be expressed in terms of Jacobi's zeta function (see 17.4.27).

$$Z(u) = E(u) - \frac{E}{K} u, \text{ where } E = E(K)$$

### 16.27. Theta Functions; Expansions in Terms of the Nome $q$

#### 16.27.1

$$\vartheta_1(z, q) = \vartheta_1(z) = 2q^{1/4} \sum_{n=0}^{\infty} (-1)^n q^{n(n+1)} \sin(2n+1)z$$

#### 16.27.2

$$\vartheta_2(z, q) = \vartheta_2(z) = 2q^{1/4} \sum_{n=0}^{\infty} q^{n(n+1)} \cos(2n+1)z$$

$$16.27.3 \quad \vartheta_3(z, q) = \vartheta_3(z) = 1 + 2 \sum_{n=1}^{\infty} q^{n^2} \cos 2nz$$

#### 16.27.4

$$\vartheta_4(z, q) = \vartheta_4(z) = 1 + 2 \sum_{n=1}^{\infty} (-1)^n q^{n^2} \cos 2nz$$

Theta functions are important because every one of the Jacobian elliptic functions can be expressed as the ratio of two theta functions. See 16.36.

The notation shows these functions as depending on the variable  $z$  and the nome  $q$ ,  $|q| < 1$ . In this case, here and elsewhere, the convergence is not dependent on the trigonometrical terms. In their relation to the Jacobian elliptic functions, we note that the nome  $q$  is given by

$$q = e^{-\pi K'/K},$$

where  $K$  and  $iK'$  are the quarter periods. Since  $q = q(m)$  is determined when the parameter  $m$  is given, we can also regard the theta functions as dependent upon  $m$  and then we write

$$\vartheta_a(z, q) = \vartheta_a(z|m), \quad a = 1, 2, 3, 4$$

but when no ambiguity is to be feared, we write  $\vartheta_a(z)$  simply.

The above notations are those given in Modern Analysis [16.6].

There is a bewildering variety of notations, for example the function  $\vartheta_1(z)$  above is sometimes denoted by  $\vartheta_0(z)$  or  $\vartheta(z)$ ; see the table given in Modern Analysis [16.6]. Further the argument  $u = 2Kz/\pi$  is frequently used so that in consulting books caution should be exercised.

### 16.28. Relations Between the Squares of the Theta Functions

$$16.28.1 \quad \vartheta_1^2(z)\vartheta_1^2(0) = \vartheta_3^2(z)\vartheta_3^2(0) - \vartheta_2^2(z)\vartheta_2^2(0)$$

$$16.28.2 \quad \vartheta_2^2(z)\vartheta_2^2(0) = \vartheta_4^2(z)\vartheta_4^2(0) - \vartheta_1^2(z)\vartheta_1^2(0)$$

$$16.28.3 \quad \vartheta_3^2(z)\vartheta_3^2(0) = \vartheta_4^2(z)\vartheta_4^2(0) - \vartheta_1^2(z)\vartheta_1^2(0)$$

$$16.28.4 \quad \vartheta_4^2(z)\vartheta_4^2(0) = \vartheta_3^2(z)\vartheta_3^2(0) - \vartheta_2^2(z)\vartheta_2^2(0)$$

$$16.28.5 \quad \vartheta_2^4(0) + \vartheta_4^4(0) = \vartheta_3^4(0)$$

Note also the important relation

$$16.28.6 \quad \vartheta_1'(0) = \vartheta_2(0)\vartheta_3(0)\vartheta_4(0) \text{ or } \vartheta_1' = \vartheta_2\vartheta_3\vartheta_4$$

### 16.29. Logarithmic Derivatives of the Theta Functions

$$16.29.1 \quad \frac{\vartheta_1'(u)}{\vartheta_1(u)} = \cot u + 4 \sum_{n=1}^{\infty} \frac{q^{2n}}{1 - q^{2n}} \sin 2nu$$



16.29.2

$$\frac{\vartheta_2'(u)}{\vartheta_2(u)} = -\tan u + 4 \sum_{n=1}^{\infty} (-1)^n \frac{q^{2n}}{1-q^{2n}} \sin 2nu$$

16.29.3  $\frac{\vartheta_3'(u)}{\vartheta_3(u)} = 4 \sum_{n=1}^{\infty} (-1)^n \frac{q^n}{1-q^{2n}} \sin 2nu$

16.29.4  $\frac{\vartheta_4'(u)}{\vartheta_4(u)} = 4 \sum_{n=1}^{\infty} \frac{q^n}{1-q^{2n}} \sin 2nu$

16.30. Logarithms of Theta Functions of Sum and Difference

16.30.1

$$\ln \frac{\vartheta_1(\alpha+\beta)}{\vartheta_1(\alpha-\beta)} = \ln \frac{\sin(\alpha+\beta)}{\sin(\alpha-\beta)} + 4 \sum_{n=1}^{\infty} \frac{1}{n} \frac{q^{2n}}{1-q^{2n}} \sin 2n\alpha \sin 2n\beta$$

16.30.2

$$\ln \frac{\vartheta_2(\alpha+\beta)}{\vartheta_2(\alpha-\beta)} = \ln \frac{\cos(\alpha+\beta)}{\cos(\alpha-\beta)} + 4 \sum_{n=1}^{\infty} \frac{(-1)^n}{n} \frac{q^{2n}}{1-q^{2n}} \sin 2n\alpha \sin 2n\beta$$

16.30.3

$$\ln \frac{\vartheta_3(\alpha+\beta)}{\vartheta_3(\alpha-\beta)} = 4 \sum_{n=1}^{\infty} \frac{(-1)^n}{n} \frac{q^n}{1-q^{2n}} \sin 2n\alpha \sin 2n\beta$$

16.30.4

$$\ln \frac{\vartheta_4(\alpha+\beta)}{\vartheta_4(\alpha-\beta)} = 4 \sum_{n=1}^{\infty} \frac{1}{n} \frac{q^n}{1-q^{2n}} \sin 2n\alpha \sin 2n\beta$$

The corresponding expressions when  $\beta = i\gamma$  are easily deduced by use of the formulae 4.3.55 and 4.3.56.

16.31. Jacobi's Notation for Theta Functions

16.31.1  $\Theta(u|m) = \Theta(u) = \vartheta_4(v), \quad v = \frac{\pi u}{2K}$

16.31.2  $\Theta_1(u|m) = \Theta_1(u) = \vartheta_3(v) = \Theta(u+K)$

16.31.3  $H(u|m) = H(u) = \vartheta_1(v)$

16.31.4  $H_1(u|m) = H_1(u) = \vartheta_2(v) = H(u+K)$

16.32. Calculation of Jacobi's Theta Function  $\Theta(u|m)$  by Use of the Arithmetic-Geometric Mean

Form the A.G.M. scale starting with

16.32.1  $a_0 = 1, b_0 = \sqrt{m_1}, c_0 = \sqrt{m}$

terminating with the  $N$ th step when  $c_N$  is negligible to the accuracy required. Find  $\varphi_N$  in degrees, where

16.32.2  $\varphi_N = 2^N a_N u \frac{180^\circ}{\pi}$

and then compute successively  $\varphi_{N-1}, \varphi_{N-2}, \dots, \varphi_1, \varphi_0$  from the recurrence relation

16.32.3  $\sin(2\varphi_{n-1} - \varphi_n) = \frac{c_n}{a_n} \sin \varphi_n$

Then

16.32.4

$$\ln \Theta(u|m) = \frac{1}{2} \ln \frac{2m_1^{1/2} K(m)}{\pi} + \frac{1}{2} \ln \frac{\cos(\varphi_1 - \varphi_0)}{\cos \varphi_0} + \frac{1}{4} \ln \sec(2\varphi_0 - \varphi_1) + \frac{1}{8} \ln \sec(2\varphi_1 - \varphi_2) + \dots + \frac{1}{2^{N+1}} \ln \sec(2\varphi_{N-1} - \varphi_N)$$

16.33. Addition of Quarter-Periods to Jacobi's Eta and Theta Functions

| $u$                      | $-u$          | $u+K$         | $u+2K$        | $u+iK'$           | $u+2iK'$          | $u+K+iK'$         | $u+2K+2iK'$       |
|--------------------------|---------------|---------------|---------------|-------------------|-------------------|-------------------|-------------------|
| 16.33.1<br>$H(u)$        | $-H(u)$       | $H_1(u)$      | $-H(u)$       | $iM(u)\Theta(u)$  | $-N(u)H(u)$       | $M(u)\Theta_1(u)$ | $N(u)H(u)$        |
| 16.33.2<br>$H_1(u)$      | $H_1(u)$      | $-H(u)$       | $-H_1(u)$     | $M(u)\Theta_1(u)$ | $N(u)H_1(u)$      | $-iM(u)\Theta(u)$ | $-N(u)H_1(u)$     |
| 16.33.3<br>$\Theta_1(u)$ | $\Theta_1(u)$ | $\Theta(u)$   | $\Theta_1(u)$ | $M(u)H_1(u)$      | $N(u)\Theta_1(u)$ | $iM(u)H(u)$       | $N(u)\Theta_1(u)$ |
| 16.33.4<br>$\Theta(u)$   | $\Theta(u)$   | $\Theta_1(u)$ | $\Theta(u)$   | $iM(u)H(u)$       | $-N(u)\Theta(u)$  | $M(u)H_1(u)$      | $-N(u)\Theta(u)$  |

where

$$M(u) = \left[ \exp\left(-\frac{\pi i u}{2K}\right) \right] q^{-i},$$

$$N(u) = \left[ \exp\left(-\frac{\pi i u}{K}\right) \right] q^{-1}$$

$H(u)$  and  $H_1(u)$  have the period  $4K$ .  $\Theta(u)$  and  $\Theta_1(u)$  have the period  $2K$ .

$2iK'$  is a quasi-period for all four functions, that is to say, increase of the argument by  $2iK'$  multiplies the function by a factor.

**16.34. Relation of Jacobi's Zeta Function to the Theta Functions**

$$Z(u) = \frac{\partial}{\partial u} \ln \Theta(u)$$

16.34.1 
$$Z(u) = \frac{\pi}{2K} \frac{\vartheta_1' \left( \frac{\pi u}{2K} \right)}{\vartheta_1 \left( \frac{\pi u}{2K} \right)} - \frac{\operatorname{cn} u \operatorname{dn} u}{\operatorname{sn} u}$$

16.34.2 
$$= \frac{\pi}{2K} \frac{\vartheta_2' \left( \frac{\pi u}{2K} \right)}{\vartheta_2 \left( \frac{\pi u}{2K} \right)} + \frac{\operatorname{dn} u \operatorname{sn} u}{\operatorname{cn} u}$$

16.34.3 
$$= \frac{\pi}{2K} \frac{\vartheta_3' \left( \frac{\pi u}{2K} \right)}{\vartheta_3 \left( \frac{\pi u}{2K} \right)} - m \frac{\operatorname{sn} u \operatorname{cn} u}{\operatorname{dn} u}$$

16.34.4 
$$= \frac{\pi}{2K} \frac{\vartheta_4' \left( \frac{\pi u}{2K} \right)}{\vartheta_4 \left( \frac{\pi u}{2K} \right)}$$

**16.35. Calculation of Jacobi's Zeta Function  $Z(u|m)$  by Use of the Arithmetic-Geometric Mean**

Form the A.G.M. scale 17.6 starting with

16.35.1 
$$a_0 = 1, b_0 = \sqrt{m_1}, c_0 = \sqrt{m}$$

terminating at the  $N$ th step when  $c_N$  is negligible to the accuracy required. Find  $\varphi_N$  in degrees where

16.35.2 
$$\varphi_N = 2^N a_N u \frac{180^\circ}{\pi}$$

and then compute successively  $\varphi_{N-1}, \varphi_{N-2}, \dots, \varphi_1, \varphi_0$  from the recurrence relation

16.35.3 
$$\sin (2\varphi_{n-1} - \varphi_n) = \frac{c_n}{a_n} \sin \varphi_n.$$

Then

**16.35.4**

$$Z(u|m) = c_1 \sin \varphi_1 + c_2 \sin \varphi_2 + \dots + c_N \sin \varphi_N.$$

**16.36. Neville's Notation for Theta Functions**

These functions are defined in terms of Jacobi's theta functions of 16.31 by

16.36.1 
$$\vartheta_s(u) = \frac{H(u)}{H'(0)}, \vartheta_c(u) = \frac{H(u+K)}{H(K)}$$

16.36.2 
$$\vartheta_d(u) = \frac{\Theta(u+K)}{\Theta(K)}, \vartheta_n(u) = \frac{\Theta(u)}{\Theta(0)}$$

If  $\lambda, \mu$  are any integers positive, negative, or zero the points  $u_0 + 2\lambda K + 2\mu iK'$  are said to be congruent to  $u_0$ .

$\vartheta_s(u)$  has zeros at the points congruent to 0  
 $\vartheta_c(u)$  has zeros at the points congruent to  $K$   
 $\vartheta_n(u)$  has zeros at the points congruent to  $iK'$   
 $\vartheta_d(u)$  has zeros at the points congruent to  $K + iK'$

Thus the suffix secures that the function  $\vartheta_p(u)$  has zeros at the points marked p in the introductory diagram in 16.1.2, and the constant by which Jacobi's function is divided secures that the leading coefficient of  $\vartheta_p(u)$  at the origin is unity. Therefore the functions have the fundamentally important property that if p, q are any two of the letters s, c, n, d, the Jacobian elliptic function  $pq u$  is given by

16.36.3 
$$pq u = \frac{\vartheta_p(u)}{\vartheta_q(u)}$$

These functions also have the property

16.36.4 
$$m_1^{-1/4} \vartheta_c(K-u) = \vartheta_s(u)$$

16.36.5 
$$m_1^{-1/4} \vartheta_d(K-u) = \vartheta_n(u),$$

for complementary arguments  $u$  and  $K-u$ .

In terms of the theta functions defined in 16.27, let  $v = \pi u / (2K)$ , then

16.36.6 
$$\vartheta_s(u) = \frac{2K \vartheta_1(v)}{\vartheta_1'(0)}, \vartheta_c(u) = \frac{\vartheta_2(v)}{\vartheta_2(0)}$$

16.36.7 
$$\vartheta_d(u) = \frac{\vartheta_3(v)}{\vartheta_3(0)}, \vartheta_n(u) = \frac{\vartheta_4(v)}{\vartheta_4(0)}$$

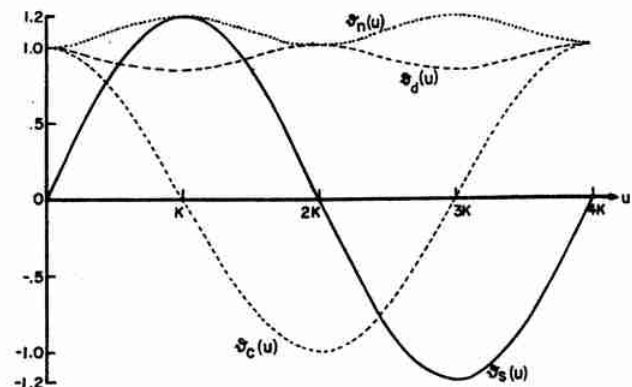

FIGURE 16.4. Neville's theta functions  $\vartheta_s(u), \vartheta_c(u), \vartheta_d(u), \vartheta_n(u)$   
 $m = \frac{1}{2}$



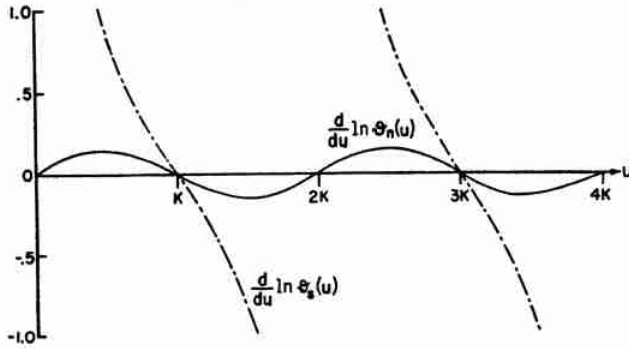

FIGURE 16.5. Logarithmic derivatives of theta functions

$$\frac{d}{du} \ln \vartheta_3(u), \frac{d}{du} \ln \vartheta_4(u)$$

$$m = \frac{1}{2}$$

**16.37. Expression as Infinite Products**

$$q = q(m), v = \pi u / (2K)$$

16.37.1

$$\vartheta_3(u) = \left(\frac{16q}{m m_1}\right)^{1/8} \sin v \prod_{n=1}^{\infty} (1 - 2q^{2n} \cos 2v + q^{4n})$$

16.37.2

$$\vartheta_4(u) = \left(\frac{16q m_1^{1/2}}{m}\right)^{1/8} \cos v \prod_{n=1}^{\infty} (1 + 2q^{2n} \cos 2v + q^{4n})$$

16.37.3

$$\vartheta_2(u) = \left(\frac{m m_1}{16q}\right)^{1/12} \prod_{n=1}^{\infty} (1 + 2q^{2n-1} \cos 2v + q^{4n-2})$$

16.37.4

$$\vartheta_1(u) = \left(\frac{m}{16q m_1^2}\right)^{1/12} \prod_{n=1}^{\infty} (1 - 2q^{2n-1} \cos 2v + q^{4n-2})$$

**Numerical Methods**

**16.39. Use and Extension of the Tables**

**Example 1.** Calculate  $nc(1.99650|.64)$  to 4S. From Table 17.1,  $1.99650 = K + .001$ . From the table of principal terms

$$nc u = -m_1^{-1/2} / (u - K) + \dots$$

$$nc(K + .001|.64) = \frac{-(.36)^{-1/2}}{.001} + \dots$$

$$= -\frac{10000}{6} + \dots$$

$$= -1667 + \dots$$

and since the next term is of order .001 this value  $-1667$  is correct to at least 4S.

**Example 2.** Use the descending Landen transformation to calculate  $dn(.20|.19)$  to 6D.

Here  $m = .19$ ,  $m_1^{1/2} = .9$  and so from 16.12.1

$$\mu = \left(\frac{1}{19}\right)^2, 1 + \mu^{1/2} = \frac{20}{19}, v = .19.$$

Also

**16.38. Expression as Infinite Series**

$$\text{Let } v = \pi u / (2K)$$

16.38.1

$$\vartheta_3(u) = \left[\frac{2\pi q^{1/2}}{m^{1/2} m_1^{1/2} K}\right]^{1/2} \sum_{n=0}^{\infty} (-1)^n q^{n(n+1)} \sin(2n+1)v$$

16.38.2  $\vartheta_4(u) = \left[\frac{2\pi q^{1/2}}{m^{1/2} K}\right]^{1/2} \sum_{n=0}^{\infty} q^{n(n+1)} \cos(2n+1)v$

16.38.3  $\vartheta_2(u) = \left[\frac{\pi}{2K}\right]^{1/2} \left\{1 + 2 \sum_{n=1}^{\infty} q^{n^2} \cos 2nv\right\}$

16.38.4

$$\vartheta_1(u) = \left[\frac{\pi}{2m_1^{1/2} K}\right]^{1/2} \left\{1 + 2 \sum_{n=1}^{\infty} (-1)^n q^{n^2} \cos 2nv\right\}$$

16.38.5  $(2K/\pi)^{1/2} = 1 + 2q + 2q^4 + 2q^9 + \dots = \vartheta_3(0, q)$

16.38.6

$$(2K'/\pi)^{1/2} = 1 + 2q_1 + 2q_1^4 + 2q_1^9 + \dots = \vartheta_3(0, q_1)$$

16.38.7

$$(2m^{1/2} K/\pi)^{1/2} = 2q^{1/4} (1 + q^2 + q^6 + q^{12} + q^{20} + \dots)$$

$$= \vartheta_2(0, q)$$

16.38.8

$$(2m_1^{1/2} K/\pi)^{1/2} = 1 - 2q + 2q^4 - 2q^9 + \dots = \vartheta_4(0, q).$$

$$\mu^2 = \left(\frac{1}{19}\right)^4 = 10^{-6} \times 7.67$$

which is negligible.

From 16.12.4

$$dn(.20|.19) = \frac{dn^2 \left[.19 \left|\left(\frac{1}{19}\right)^2\right] - \left(1 - \frac{1}{19}\right)}{\left(1 + \frac{1}{19}\right) - dn^2 \left[.19 \left|\left(\frac{1}{19}\right)^2\right]}\right.$$

Now from 16.13.3

$$dn \left[.19 \left|\left(\frac{1}{19}\right)^2\right] = .999951$$

whence  $dn(.20|.19) = .996253$ .

**Example 3.** Use the ascending Landen transformation to calculate  $dn(.20|.81)$  to 5D.

From 16.14.1

$$\mu = \frac{4(.9)}{(1.9)^2} = \frac{360}{361}, \mu_1 = \left(\frac{1}{19}\right)^2$$

$$1 + \mu_1^{1/2} = \frac{20}{19}, v = \frac{19}{20} \times .20 = .19,$$

$\mu_1^2$  is negligible to 4D. Thus

**Example 7.** Use the  $q$ -series to compute  $\text{cs}(.53601\ 62|.09)$ .

Here we use the series 16.23.12,  $K=1.60804\ 862$ ,  $q=.00589\ 414$ ,  $v=\frac{\pi u}{2K}=\frac{\pi}{6}$  radians or  $30^\circ$ .

Since  $q^4$  is negligible to 8D, we have to 7D  $\text{cs}(.53601\ 62|.09)$

$$\begin{aligned} &= \frac{\pi}{2K} \cot 30^\circ - \frac{2\pi}{K} \left\{ \frac{q^2}{1+q^2} \sin 60^\circ \right\} \\ &= (.97683\ 3852)(1.73205\ 081) \\ &\quad - 3.90733\ 541[(.00003\ 4740)(.86602\ 5404)] \\ &= 1.69180\ 83. \end{aligned}$$

**Example 8.** Use theta functions to compute  $\text{sn}(.61802|.5)$  to 5D.

Here  $K(\frac{1}{2})=1.85407$

$$\begin{aligned} \epsilon^\circ &= \frac{.61802}{1.85407} \times 90^\circ = 30^\circ \\ \sin^2 \alpha &= 1/2, \alpha = 45^\circ. \end{aligned}$$

Thus

$$\begin{aligned} \text{sn}(.61802|.5) &= \frac{\vartheta_2(30^\circ \setminus 45^\circ)}{\vartheta_3(30^\circ \setminus 45^\circ)} \\ &= \frac{.59128}{1.04729} = .56458 \end{aligned}$$

from Table 16.1.

**Example 9.** Use theta functions to compute  $\text{sc}(.61802|.5)$  to 5D.

As in the preceding example

$$\epsilon^\circ = 30^\circ, \alpha^\circ = 45^\circ$$

so that

$$\text{sc}(.61802|.5) = \frac{\vartheta_2(30^\circ \setminus 45^\circ)}{\vartheta_4(30^\circ \setminus 45^\circ)}$$

We use Table 16.1 to give

$$\vartheta_2(30^\circ \setminus 45^\circ) = .59128$$

$$(\sec 45^\circ)^{\frac{1}{2}} \vartheta_4(30^\circ \setminus 45^\circ) = 1.02796.$$

Therefore

$$\begin{aligned} \text{sc}(.61802|.5) &= \frac{.59128}{1.02796} (\sec 45^\circ)^{\frac{1}{2}} \\ &= .68402. \end{aligned}$$

**Example 10.** Find  $\text{sn}(.75342|.7)$  by inverse interpolation in Table 17.5.

This method is explained in chapter 17, Example 7.

**Example 11.** Find  $u$ , given that  $\text{cs}(u|.5) = .75$ . From 16.9.4 we have

$$\text{sn}^2 u = \frac{1}{1 + \text{cs}^2 u}$$

Thus

$$\text{sn}^2(u|.5) = .64$$

and

$$\text{sn}(u|.5) = .8.$$

We have therefore replaced the problem by that of finding  $u$  given  $\text{sn}(u|m)$ , where  $m$  is known. If  $\varphi = \text{am } u$

$\sin \varphi = \text{sn } u$  and so

$$\varphi = .9272952 \text{ radians or } 53.13010^\circ.$$

From Table 17.5,

$$u = F(53.13010^\circ \setminus 45^\circ) = .99391.$$

Alternatively, starting with the above value of  $\varphi$  we can use the A.G.M. scale to calculate  $F(\varphi \setminus \alpha)$  as explained in 17.6. This method is to be preferred if more figures are required, or if  $\alpha$  differs from a tabular value in Table 17.5.

## References

### Texts

- [16.1] A. Erdélyi et al., Higher transcendental functions, vol. 2 (McGraw-Hill Book Co., Inc., New York, N.Y., 1953).
- [16.2] L. V. King, On the direct numerical calculation of elliptic functions and integrals (Cambridge Univ. Press, Cambridge, England, 1924).
- [16.3] W. Magnus and F. Oberhettinger, Formulas and theorems for the special functions of mathematical physics (Chelsea Publishing Co., New York, N.Y., 1949).
- [16.4] E. H. Neville, Jacobian elliptic functions, 2d ed. (Oxford Univ. Press, London, England, 1951).
- [16.5] F. Tricomi, Elliptische Funktionen (Akademische Verlagsgesellschaft, Leipzig, Germany, 1948).
- [16.6] E. T. Whittaker and G. N. Watson, A course of modern analysis, chs. 20, 21, 22, 4th ed. (Cambridge Univ. Press, Cambridge, England, 1952).

### Tables

- [16.7] E. P. Adams and R. L. Hippisley, Smithsonian mathematical formulae and tables of elliptic functions, 3d reprint (The Smithsonian Institution, Washington, D.C., 1957).
- [16.8] J. Hoüel, Recueil de formules et de tables numériques (Gauthier-Villars, Paris, France, 1901).
- [16.9] E. Jahnke and F. Emde, Tables of functions, 4th ed. (Dover Publications, Inc., New York, N.Y., 1945).
- [16.10] L. M. Milne-Thomson, Die elliptischen Funktionen von Jacobi (Julius Springer, Berlin, Germany, 1931).
- [16.11] L. M. Milne-Thomson, Jacobian elliptic function tables (Dover Publications, Inc., New York, N.Y., 1956).
- [16.12] G. W. and R. M. Spenceley, Smithsonian elliptic function tables, Smithsonian Miscellaneous Collection, vol. 109 (Washington, D.C., 1947).

# 17. Elliptic Integrals

L. M. MILNE-THOMSON<sup>1</sup>

## Contents

|  | Page |
|--|------|
| <b>Mathematical Properties</b> . . . . .   | 589  |
| 17.1. Definition of Elliptic Integrals . . . . .   | 589  |
| 17.2. Canonical Forms . . . . .  | 589  |
| 17.3. Complete Elliptic Integrals of the First and Second Kinds . . . . .  | 590  |
| 17.4. Incomplete Elliptic Integrals of the First and Second Kinds . . . . .  | 592  |
| 17.5. Landen's Transformation . . . . .  | 597  |
| 17.6. The Process of the Arithmetic-Geometric Mean . . . . .   | 598  |
| 17.7. Elliptic Integrals of the Third Kind . . . . .   | 599  |
| <b>Numerical Methods</b> . . . . .   | 600  |
| 17.8. Use and Extension of the Tables . . . . .  | 600  |
| <b>References</b> . . . . .  | 606  |
| <b>Table 17.1. Complete Elliptic Integrals of the First and Second Kinds and the Nome <math>q</math> With Argument the Parameter <math>m</math></b> . . . . .          | 608  |
| $K(m), K'(m), 15D; q(m), q_1(m), 15D; E(m), E'(m), 9D$<br>$m=0(.01)1$  |      |
| <b>Table 17.2. Complete Elliptic Integrals of the First and Second Kinds and the Nome <math>q</math> With Argument the Modular Angle <math>\alpha</math></b> . . . . . | 610  |
| $K(\alpha), K'(\alpha), q(\alpha), q_1(\alpha), E(\alpha), E'(\alpha), 15D$<br>$\alpha=0^\circ(1^\circ)90^\circ$   |      |
| <b>Table 17.3. Parameter <math>m</math> With Argument <math>K'(m)/K(m)</math></b> . . . . .  | 612  |
| $K'(m)/K(m)=.3(.02)3, 10D$   |      |
| <b>Table 17.4. Auxiliary Functions for Computation of the Nome <math>q</math> and the Parameter <math>m</math></b> . . . . .   | 612  |
| $Q(m)=q_1(m)/m_1, 15D$<br>$L(m)=-K(m)+\frac{K'(m)}{\pi} \ln\left(\frac{16}{m_1}\right), 10D$<br>$m_1=0(.01).15$  |      |
| <b>Table 17.5. Elliptic Integral of the First Kind <math>F(\varphi\backslash\alpha)</math></b> . . . . .   | 613  |
| $\alpha=0^\circ(2^\circ)90^\circ, 5^\circ(10^\circ)85^\circ, \varphi=0^\circ(5^\circ)90^\circ, 8D$   |      |
| <b>Table 17.6. Elliptic Integral of the Second Kind <math>E(\varphi\backslash\alpha)</math></b> . . . . .  | 616  |
| $\alpha=0^\circ(2^\circ)90^\circ, 5^\circ(10^\circ)85^\circ, \varphi=0^\circ(5^\circ)90^\circ, 8D$   |      |

<sup>1</sup> University of Arizona. (Prepared under contract with the National Bureau of Standards.)

# 17. Elliptic Integrals

## Mathematical Properties

### 17.1. Definition of Elliptic Integrals

If  $R(x, y)$  is a rational function of  $x$  and  $y$ , where  $y^2$  is equal to a cubic or quartic polynomial in  $x$ , the integral

$$17.1.1 \quad \int R(x, y) dx$$

is called an *elliptic integral*.

The elliptic integral just defined can not, in general, be expressed in terms of elementary functions.

Exceptions to this are

- (i) when  $R(x, y)$  contains no odd powers of  $y$ .
- (ii) when the polynomial  $y^2$  has a repeated factor.

We therefore exclude these cases.

By substituting for  $y^2$  and denoting by  $p_s(x)$  a polynomial in  $x$  we get<sup>2</sup>

$$\begin{aligned} R(x, y) &= \frac{p_1(x) + yp_2(x)}{p_3(x) + yp_4(x)} \\ &= \frac{[p_1(x) + yp_2(x)][p_3(x) - yp_4(x)]y}{\{[p_3(x)]^2 - y^2[p_4(x)]^2\}y} \\ &= \frac{p_5(x) + yp_6(x)}{yp_7(x)} = R_1(x) + \frac{R_2(x)}{y} \end{aligned}$$

where  $R_1(x)$  and  $R_2(x)$  are rational functions of  $x$ . Hence, by expressing  $R_2(x)$  as the sum of a polynomial and partial fractions

$$\begin{aligned} \int R(x, y) dx &= \int R_1(x) dx + \sum A_s \int x^s y^{-1} dx \\ &\quad + \sum B_s \int [(x-c)^s y]^{-1} dx \end{aligned}$$

#### Reduction Formulae

Let

#### 17.1.2

$$\begin{aligned} y^2 &= a_0x^4 + a_1x^3 + a_2x^2 + a_3x + a_4 \quad (|a_0| + |a_1| \neq 0) \\ &= b_0(x-c)^4 + b_1(x-c)^3 + b_2(x-c)^2 + b_3(x-c) + b_4 \\ &\quad (|b_0| + |b_1| \neq 0) \end{aligned}$$

$$17.1.3 \quad I_s = \int x^s y^{-1} dx, \quad J_s = \int [y(x-c)^s]^{-1} dx$$

By integrating the derivatives of  $yx^s$  and  $y(x-c)^{-s}$  we get the reduction formulae

#### 17.1.4

$$\begin{aligned} (s+2)a_0I_{s+3} + \frac{1}{2}a_1(2s+3)I_{s+2} + a_2(s+1)I_{s+1} \\ + \frac{1}{2}a_3(2s+1)I_s + sa_4I_{s-1} = x^s y \quad (s=0, 1, 2, \dots) \end{aligned}$$

<sup>2</sup> See [17.7] 22.72.

#### 17.1.5

$$\begin{aligned} (2-s)b_0J_{s-3} + \frac{1}{2}b_1(3-2s)J_{s-2} + b_2(1-s)J_{s-1} \\ + \frac{1}{2}b_3(1-2s)J_s - sb_4J_{s+1} = y(x-c)^{-s} \\ (s=1, 2, 3, \dots) \end{aligned}$$

By means of these reduction formulae and certain transformations (see **Examples 1 and 2**) every elliptic integral can be brought to depend on the integral of a rational function and on three canonical forms for elliptic integrals.

### 17.2. Canonical Forms

#### Definitions

#### 17.2.1

$m = \sin^2 \alpha$ ;  $m$  is the parameter,  
 $\alpha$  is the modular angle

#### 17.2.2

$$x = \sin \varphi = \operatorname{sn} u$$

#### 17.2.3

$$\cos \varphi = \operatorname{cn} u$$

#### 17.2.4

$(1 - m \sin^2 \varphi)^{\frac{1}{2}} = \operatorname{dn} u = \Delta(\varphi)$ , the delta amplitude

#### 17.2.5

$\varphi = \arcsin(\operatorname{sn} u) = \operatorname{am} u$ , the amplitude

#### Elliptic Integral of the First Kind

$$17.2.6 \quad F(\varphi \setminus \alpha) = F(\varphi | m) = \int_0^\varphi (1 - \sin^2 \alpha \sin^2 \theta)^{-\frac{1}{2}} d\theta$$

#### 17.2.7

$$\begin{aligned} &= \int_0^x [(1-t^2)(1-mt^2)]^{-\frac{1}{2}} dt \\ &= \int_0^u dw = u \end{aligned}$$

#### Elliptic Integral of the Second Kind

$$17.2.8 \quad E(\varphi \setminus \alpha) = E(u | m) = \int_0^x (1-t^2)^{-\frac{1}{2}} (1-mt^2)^{\frac{1}{2}} dt$$

#### 17.2.9

$$= \int_0^\varphi (1 - \sin^2 \alpha \sin^2 \theta)^{\frac{1}{2}} d\theta$$

#### 17.2.10

$$= \int_0^u \operatorname{dn}^2 w dw$$

#### 17.2.11

$$= m_1 u + m \int_0^u \operatorname{cn}^2 w dw$$

$$17.2.12 \quad E(\varphi \setminus \alpha) = u - m \int_0^u \operatorname{sn}^2 w \, dw$$

$$17.2.13 \quad = \frac{\pi}{2K(m)} \frac{\vartheta'_4(\pi u/2K)}{\vartheta_4(\pi u/2K)} + \frac{E(m)u}{K(m)}$$

(For theta functions, see chapter 16.)

#### Elliptic Integral of the Third Kind

17.2.14

$$\Pi(n; \varphi \setminus \alpha) = \int_0^\varphi (1 - n \sin^2 \theta)^{-1} [1 - \sin^2 \alpha \sin^2 \theta]^{-1/2} d\theta$$

If  $x = \operatorname{sn}(u|m)$ ,

17.2.15

$$\Pi(n; u|m) = \int_0^x (1 - nt^2)^{-1} [(1 - t^2)(1 - mt^2)]^{-1/2} dt$$

$$17.2.16 \quad = \int_0^u (1 - n \operatorname{sn}^2(w|m))^{-1} dw$$

The Amplitude  $\varphi$

$$17.2.17 \quad \varphi = \operatorname{am} u = \arcsin(\operatorname{sn} u) = \arcsin x$$

can be calculated from Tables 17.5 and 4.14.

#### The Parameter $m$

Dependence on the parameter  $m$  is denoted by a vertical stroke preceding the parameter, e.g.,  $F(\varphi|m)$ .

Together with the parameter we define the complementary parameter  $m_1$  by

$$17.2.18 \quad m + m_1 = 1$$

When the parameter is real, it can always be arranged, see 17.4, that  $0 \leq m \leq 1$ .

#### The Modular Angle $\alpha$

Dependence on the modular angle  $\alpha$ , defined in terms of the parameter by 17.2.1, is denoted by a backward stroke  $\setminus$  preceding the modular angle, thus  $E(\varphi \setminus \alpha)$ . The complementary modular angle is  $\pi/2 - \alpha$  or  $90^\circ - \alpha$  according to the unit and thus  $m_1 = \sin^2(90^\circ - \alpha) = \cos^2 \alpha$ .

#### The Modulus $k$

In terms of Jacobian elliptic functions (chapter 16), the modulus  $k$  and the complementary modulus are defined by

$$17.2.19 \quad k = \operatorname{ns}(K + iK'), \quad k' = \operatorname{dn} K.$$

They are related to the parameter by  $k^2 = m$ ,  $k'^2 = m_1$ .

Dependence on the modulus is denoted by a comma preceding it, thus  $\Pi(n; u, k)$ .

In computation the modulus is of minimal importance, since it is the parameter and its complement which arise naturally. The parameter and the modular angle will be employed in this chapter to the exclusion of the modulus.

#### The Characteristic $n$

The elliptic integral of the third kind depends on three variables namely (i) the parameter, (ii) the amplitude, (iii) the characteristic  $n$ . When real, the characteristic may be any number in the interval  $(-\infty, \infty)$ . The properties of the integral depend upon the location of the characteristic in this interval, see 17.7.

#### 17.3. Complete Elliptic Integrals of the First and Second Kinds

Referred to the canonical forms of 17.2, the elliptic integrals are said to be *complete* when the amplitude is  $\frac{1}{2}\pi$  and so  $x=1$ . These complete integrals are designated as follows

17.3.1

$$[K(m)] = K = \int_0^1 [(1-t^2)(1-mt^2)]^{-1/2} dt \\ = \int_0^{\pi/2} (1-m \sin^2 \theta)^{-1/2} d\theta$$

$$17.3.2 \quad K = F(\frac{1}{2}\pi|m) = F(\frac{1}{2}\pi \setminus \alpha)$$

17.3.3

$$E[K(m)] = E = \int_0^1 (1-t^2)^{-1/2} (1-mt^2)^{1/2} dt \\ = \int_0^{\pi/2} (1-m \sin^2 \theta)^{1/2} d\theta$$

$$17.3.4 \quad E = E[K(m)] = E(m) = E(\frac{1}{2}\pi \setminus \alpha)$$

We also define

17.3.5

$$K' = K(m_1) = K(1-m) = \int_0^{\pi/2} (1-m_1 \sin^2 \theta)^{-1/2} d\theta$$

$$17.3.6 \quad K' = F(\frac{1}{2}\pi|m_1) = F(\frac{1}{2}\pi \setminus \frac{1}{2}\pi - \alpha)$$

17.3.7

$$E' = E(m_1) = E(1-m) = \int_0^{\pi/2} (1-m_1 \sin^2 \theta)^{1/2} d\theta$$

$$17.3.8 \quad E' = E[K(m_1)] = E(m_1) = E(\frac{1}{2}\pi \setminus \frac{1}{2}\pi - \alpha)$$

$K$  and  $iK'$  are the "real" and "imaginary" quarter-periods of the corresponding Jacobian elliptic functions (see chapter 16).

**Relation to the Hypergeometric Function**  
(see chapter 15)

17.3.9  $K = \frac{1}{2} \pi F(\frac{1}{2}, \frac{1}{2}; 1; m)$

17.3.10  $E = \frac{1}{2} \pi F(-\frac{1}{2}, \frac{1}{2}; 1; m)$

**Infinite Series**

17.3.11

$$K(m) = \frac{1}{2} \pi \left[ 1 + \left(\frac{1}{2}\right)^2 m + \left(\frac{1 \cdot 3}{2 \cdot 4}\right)^2 m^2 + \left(\frac{1 \cdot 3 \cdot 5}{2 \cdot 4 \cdot 6}\right)^2 m^3 + \dots \right] \quad (|m| < 1)$$

17.3.12

$$E(m) = \frac{1}{2} \pi \left[ 1 - \left(\frac{1}{2}\right)^2 \frac{m}{1} - \left(\frac{1 \cdot 3}{2 \cdot 4}\right)^2 \frac{m^2}{3} - \left(\frac{1 \cdot 3 \cdot 5}{2 \cdot 4 \cdot 6}\right)^2 \frac{m^3}{5} - \dots \right] \quad (|m| < 1)$$

**Legendre's Relation**

17.3.13  $EK' + E'K - KK' = \frac{1}{2} \pi$

**Auxiliary Function**

17.3.14  $L(m) = \frac{K'(m)}{\pi} \ln \frac{16}{m_1} - K(m)$

17.3.15  $m = 1 - 16 \exp [-\pi(K(m) + L(m))/K'(m)]$

17.3.16  $m = 16 \exp [-\pi(K'(m) + L(m_1))/K(m)]$

The function  $L(m)$  is tabulated in Table 17.4.

**q-Series**

The Nome  $q$  and the Complementary Nome  $q_1$

17.3.17  $q = q(m) = \exp [-\pi K'/K]$

17.3.18  $q_1 = q(m_1) = \exp [-\pi K/K']$

17.3.19  $\ln \frac{1}{q'} \ln \frac{1}{q_1} = \pi^2$

17.3.20

$$\log_{10} \frac{1}{q} \log_{10} \frac{1}{q_1} = (\pi \log_{10} e)^2 = 1.86152 \ 28349 \text{ to } 10D$$

17.3.21

$$q = \exp [-\pi K'/K] = \frac{m}{16} + 8 \left(\frac{m}{16}\right)^2 + 84 \left(\frac{m}{16}\right)^3 + 992 \left(\frac{m}{16}\right)^4 + \dots \quad (|m| < 1)$$

17.3.22  $K = \frac{1}{2} \pi + 2\pi \sum_{s=1}^{\infty} \frac{q^s}{1+q^{2s}}$

17.3.23

$$\frac{E}{K} = \frac{1}{3} (1+m_1) + (\pi/K)^2 \left[ 1/12 - 2 \sum_{s=1}^{\infty} q^{2s} (1-q^{2s})^{-2} \right]$$

17.3.24  $\text{am } u = v + \sum_{s=1}^{\infty} \frac{2q^s \sin 2sv}{s(1+q^{2s})}$  where  $v = \pi u / (2K)$

**Limiting Values**

17.3.25  $\lim_{m \rightarrow 0} K'(E-K) = 0$

17.3.26  $\lim_{m \rightarrow 1} [K - \frac{1}{2} \ln (16/m_1)] = 0$

17.3.27  $\lim_{m \rightarrow 0} m^{-1}(K-E) = \lim_{m \rightarrow 0} m^{-1}(E - m_1 K) = \pi/4$

17.3.28  $\lim_{m \rightarrow 0} q/m = \lim_{m_1 \rightarrow 1} q_1/m_1 = 1/16$

**Alternative Evaluations of  $K$  and  $E$**  (see also 17.5)

17.3.29

$$K(m) = 2[1+m_1^{1/2}]^{-1} K([(1-m_1^{1/2})/(1+m_1^{1/2})]^2)^*$$

17.3.30

$$E(m) = (1+m_1^{1/2}) E([(1-m_1^{1/2})/(1+m_1^{1/2})]^2) - 2m_1^{1/2} (1+m_1^{1/2})^{-1} K([(1-m_1^{1/2})/(1+m_1^{1/2})]^2)$$

17.3.31  $K(\alpha) = 2F(\arctan (\sec^{1/2} \alpha) \setminus \alpha)$

17.3.32  $E(\alpha) = 2E(\arctan (\sec^{1/2} \alpha) \setminus \alpha) - 1 + \cos \alpha$

**Polynomial Approximations**<sup>3</sup> ( $0 \leq m < 1$ )

17.3.33

$$K(m) = [a_0 + a_1 m_1 + a_2 m_1^2] + [b_0 + b_1 m_1 + b_2 m_1^2] \ln (1/m_1) + \epsilon(m) \quad |\epsilon(m)| \leq 3 \times 10^{-5}$$

|                      |                     |
|----------------------|---------------------|
| $a_0 = 1.38629 \ 44$ | $b_0 = .5$          |
| $a_1 = .11197 \ 23$  | $b_1 = .12134 \ 78$ |
| $a_2 = .07252 \ 96$  | $b_2 = .02887 \ 29$ |

17.3.34

$$K(m) = [a_0 + a_1 m_1 + \dots + a_4 m_1^4] + [b_0 + b_1 m_1 + \dots + b_4 m_1^4] \ln (1/m_1) + \epsilon(m) \quad |\epsilon(m)| \leq 2 \times 10^{-8}$$

|                          |                         |
|--------------------------|-------------------------|
| $a_0 = 1.38629 \ 436112$ | $b_0 = .5$              |
| $a_1 = .09666 \ 344259$  | $b_1 = .12498 \ 593597$ |
| $a_2 = .03590 \ 092383$  | $b_2 = .06880 \ 248576$ |
| $a_3 = .03742 \ 563713$  | $b_3 = .03328 \ 355346$ |
| $a_4 = .01451 \ 196212$  | $b_4 = .00441 \ 787012$ |

<sup>3</sup> The approximations 17.3.33-17.3.36 are from C. Hastings, Jr., Approximations for Digital Computers, Princeton Univ. Press, Princeton, N. J. (with permission).

\*See page 11.



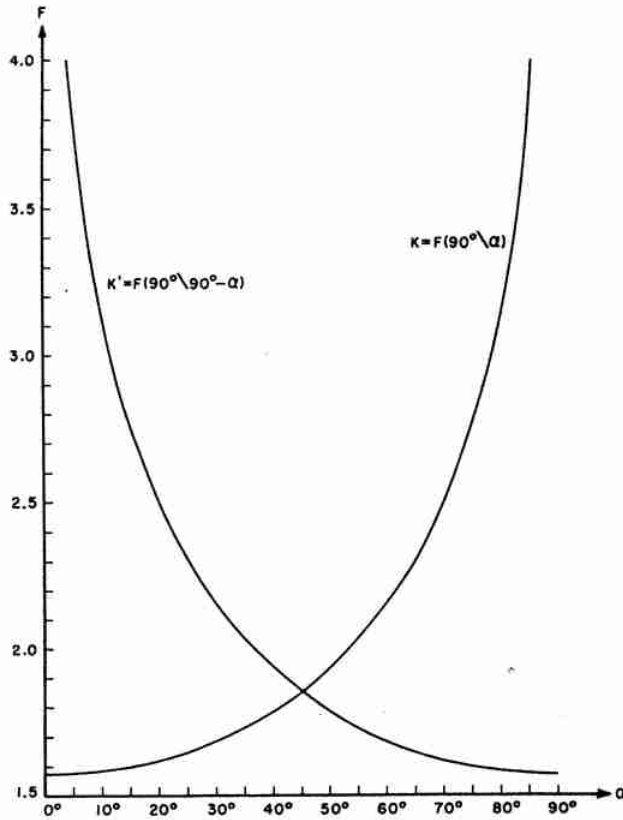

FIGURE 17.1. Complete elliptic integral of the first kind.

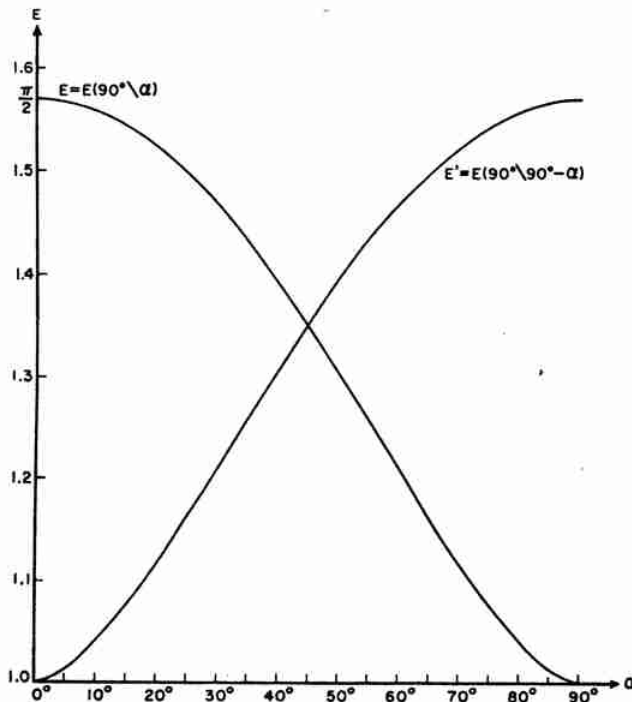

FIGURE 17.2. Complete elliptic integral of the second kind.

17.3.35

$$E(m) = [1 + a_1 m_1 + a_2 m_1^2] + [b_1 m_1 + b_2 m_1^2] \ln(1/m_1) + \epsilon(m)$$

$$|\epsilon(m)| < 4 \times 10^{-8}$$

$$\begin{matrix} a_1 = .46301 & 51 & b_1 = .24527 & 27 \\ a_2 = .10778 & 12 & b_2 = .04124 & 96 \end{matrix}$$

17.3.36

$$E(m) = [1 + a_1 m_1 + \dots + a_4 m_1^4] + [b_1 m_1 + \dots + b_4 m_1^4] \ln(1/m_1) + \epsilon(m)$$

$$|\epsilon(m)| < 2 \times 10^{-8}$$

$$\begin{matrix} a_1 = .44325 & 141463 & b_1 = .24998 & 368310 \\ a_2 = .06260 & 601220 & b_2 = .09200 & 180037 \\ a_3 = .04757 & 383546 & b_3 = .04069 & 697526 \\ a_4 = .01736 & 506451 & b_4 = .00526 & 449639 \end{matrix}$$

17.4. Incomplete Elliptic Integrals of the First and Second Kinds

Extension of the Tables

Negative Amplitude

17.4.1  $F(-\varphi|m) = -F(\varphi|m)$

17.4.2  $E(-\varphi|m) = -E(\varphi|m)$

Amplitude of Any Magnitude

17.4.3  $F(s\pi \pm \varphi|m) = 2sK \pm F(\varphi|m)$

17.4.4  $E(u + 2K) = E(u) + 2E$

17.4.5  $E(u + 2iK') = E(u) + 2i(K' - E')$

17.4.6

$$E(u + 2mK + 2niK') = E(u) + 2mE + 2ni(K' - E')$$

17.4.7  $E(K - u) = E - E(u) + msn u \operatorname{cd} u$

Imaginary Amplitude

If  $\tan \theta = \sinh \varphi$

17.4.8  $F(i\varphi \setminus \alpha) = iF(\theta \setminus \frac{1}{2}\pi - \alpha)$

17.4.9

$$E(i\varphi \setminus \alpha) = -iE(\theta \setminus \frac{1}{2}\pi - \alpha) + iF(\theta \setminus \frac{1}{2}\pi - \alpha) + i \tan \theta (1 - \cos^2 \alpha \sin^2 \theta)^{\frac{1}{2}}$$

Jacobi's Imaginary Transformation

17.4.10

$$E(iu|m) = i[u + \operatorname{dn}(u|m_1) \operatorname{sc}(u|m_1) - E(u|m_1)]$$

Complex Amplitude

17.4.11  $F(\varphi + i\psi|m) = F(\lambda|m_1) + iF(\mu|m_1)$



where  $\cot^2 \lambda$  is the positive root of the equation  $x^2 - [\cot^2 \varphi + m \sinh^2 \psi \csc^2 \varphi - m_1]x - m_1 \cot^2 \varphi = 0$  and  $m \tan^2 \mu = \tan^2 \varphi \cot^2 \lambda - 1$ .

17.4.12

$$E(\varphi + i\psi \backslash \alpha) = E(\lambda \backslash \alpha) - iE(\mu \backslash 90^\circ - \alpha) + iF(\mu \backslash 90^\circ - \alpha) + \frac{b_1 + ib_2}{b_3}$$

where

$$\begin{aligned} b_1 &= \sin^2 \alpha \sin \lambda \cos \lambda \sin^2 \mu (1 - \sin^2 \alpha \sin^2 \lambda)^{\frac{1}{2}} \\ b_2 &= (1 - \sin^2 \alpha \sin^2 \lambda) (1 - \cos^2 \alpha \sin^2 \mu)^{\frac{1}{2}} \sin \mu \cos \mu \\ b_3 &= \cos^2 \mu + \sin^2 \alpha \sin^2 \lambda \sin^2 \mu \end{aligned}$$

Amplitude Near to  $\pi/2$  (see also 17.5)

$$\text{If } \cos \alpha \tan \varphi \tan \psi = 1$$

17.4.13  $F(\varphi \backslash \alpha) + F(\psi \backslash \alpha) = F(\pi/2 \backslash \alpha) = K$

17.4.14

$$E(\varphi \backslash \alpha) + E(\psi \backslash \alpha) = E(\pi/2 \backslash \alpha) + \sin^2 \alpha \sin \varphi \sin \psi$$

Values when  $\varphi$  is near to  $\pi/2$  and  $m$  is near to unity can be calculated by these formulae.

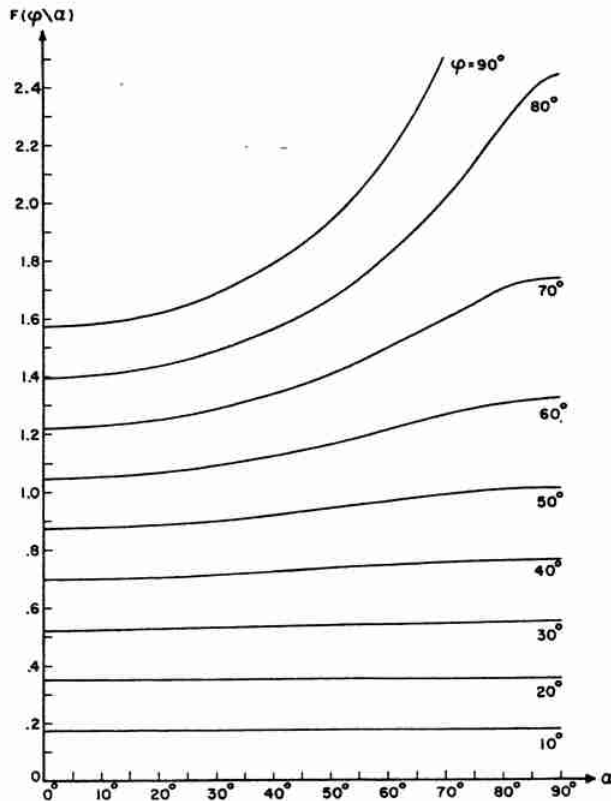

FIGURE 17.3. Incomplete elliptic integral of the first kind.  
 $F(\varphi \backslash \alpha)$ ,  $\varphi$  constant

Parameter Greater Than Unity

17.4.15  $F(\varphi | m) = m^{-\frac{1}{2}} F(\theta | m^{-1})$ ,  $\sin \theta = m^{\frac{1}{2}} \sin \varphi$

17.4.16  $E(u | m) = m^{\frac{1}{2}} E(um^{\frac{1}{2}} | m^{-1}) - (m-1)u$

by which a parameter greater than unity can be replaced by a parameter less than unity.

Negative Parameter

17.4.17

$$\begin{aligned} F(\varphi | -m) &= (1+m)^{-\frac{1}{2}} K(m(1+m)^{-1}) \\ &\quad - (1+m)^{-\frac{1}{2}} F\left(\frac{\pi}{2} - \varphi | m(1+m)^{-1}\right) \end{aligned}$$

17.4.18

$$\begin{aligned} E(u | -m) &= (1+m)^{\frac{1}{2}} \{ E(u(1+m)^{\frac{1}{2}} | m(m+1)^{-1}) \\ &\quad - m(1+m)^{-\frac{1}{2}} \text{sn}(u(1+m)^{\frac{1}{2}} | m(1+m)^{-1}) \\ &\quad \text{cd}(u(1+m)^{\frac{1}{2}} | m(1+m)^{-1}) \} \end{aligned}$$

whereby computations can be made for negative parameters, and therefore for pure imaginary modulus.

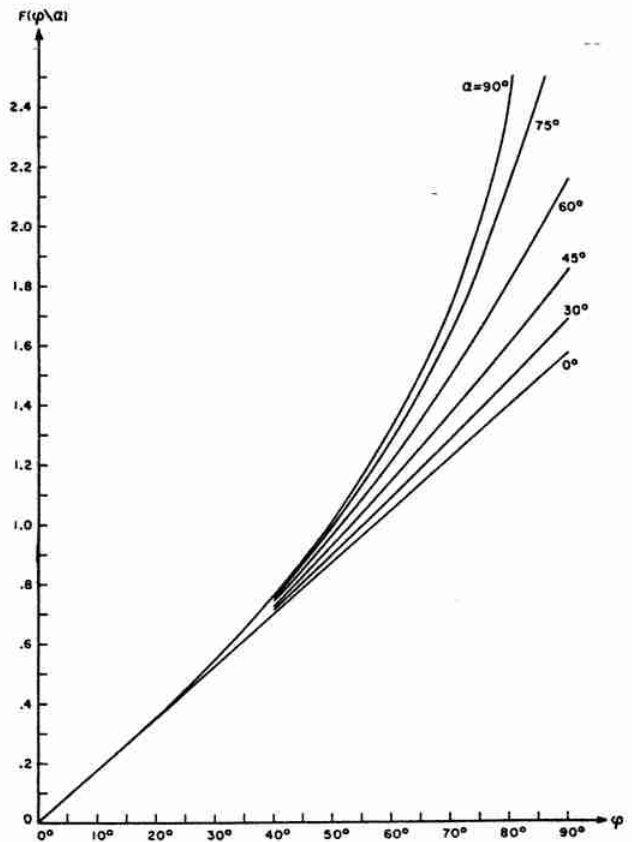

FIGURE 17.4. Incomplete elliptic integral of the first kind.  
 $F(\varphi \backslash \alpha)$ ,  $\alpha$  constant

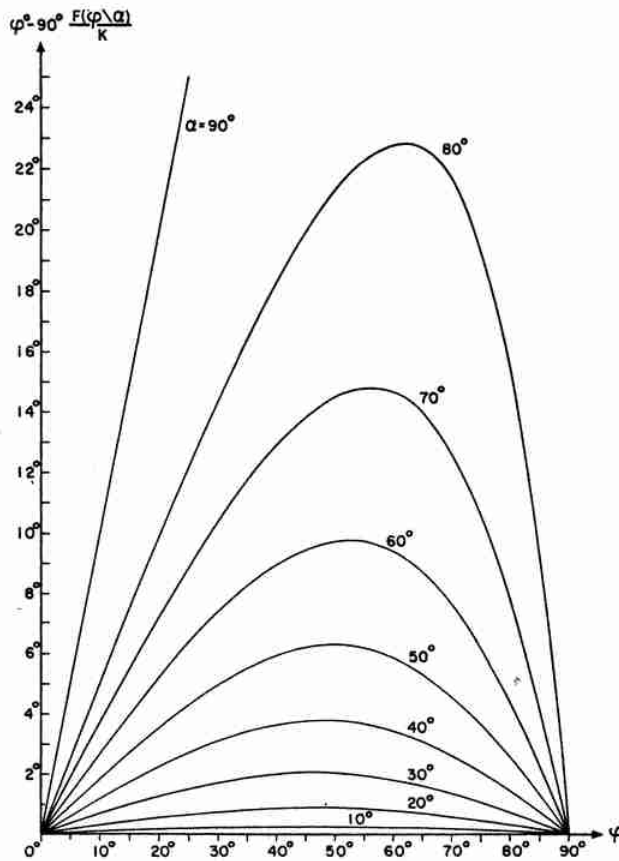

FIGURE 17.5.  $\varphi - 90^\circ \frac{F(\varphi \setminus \alpha)}{K}$ ,  $\alpha$  constant.

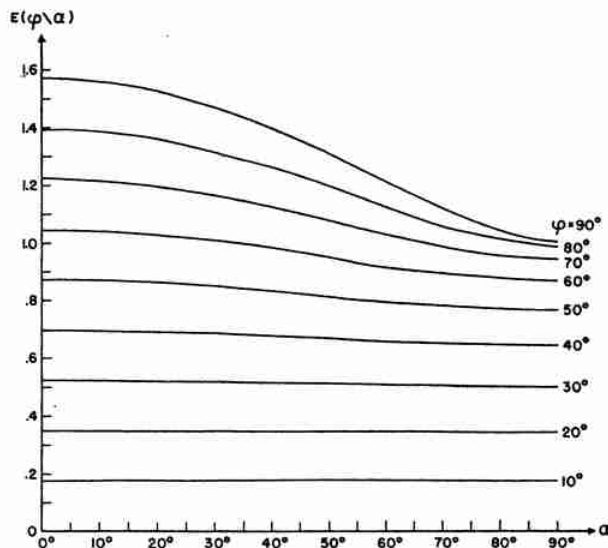

FIGURE 17.6. Incomplete elliptic integral of the second kind.

$E(\varphi \setminus \alpha)$ ,  $\varphi$  constant

**Special Cases**

17.4.19  $F(\varphi \setminus 0) = \varphi$

17.4.20  $F(i\varphi \setminus 0) = i\varphi$

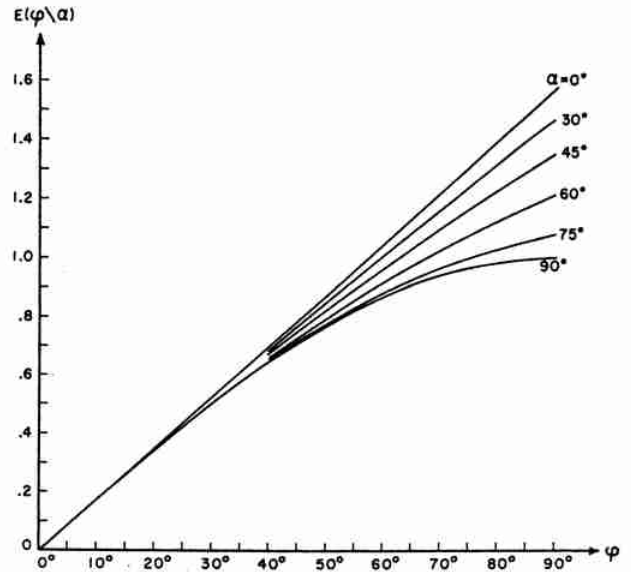

FIGURE 17.7. Incomplete elliptic integral of the second kind.

$E(\varphi \setminus \alpha)$ ,  $\alpha$  constant

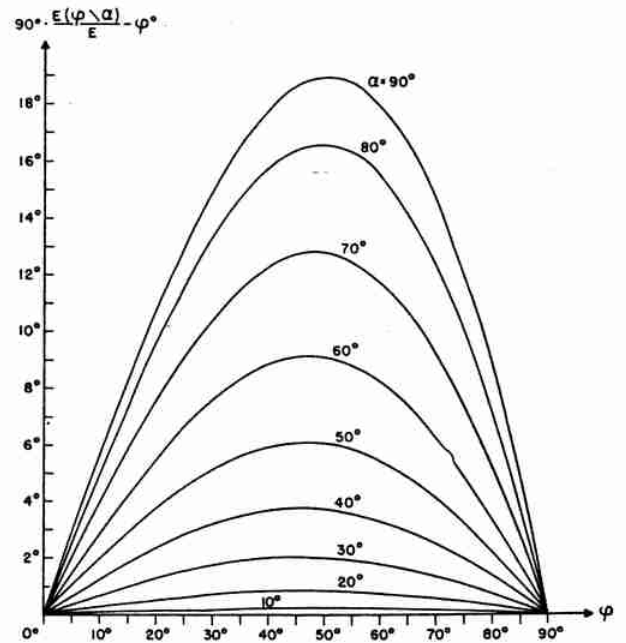

FIGURE 17.8.  $90^\circ \frac{E(\varphi \setminus \alpha)}{E} - \varphi$ ,  $\alpha$  constant.

**17.4.21**

$$F(\varphi \setminus 90^\circ) = \ln(\sec \varphi + \tan \varphi) = \ln \tan \left( \frac{\pi}{4} + \frac{\varphi}{2} \right)$$

17.4.22  $F(i\varphi \setminus 90^\circ) = i \arctan(\sinh \varphi)$

17.4.23  $E(\varphi \setminus 0) = \varphi$

17.4.24  $E(i\varphi \setminus 0) = i\varphi$

17.4.25  $E(\varphi \setminus 90^\circ) = \sin \varphi$

17.4.26  $E(i\varphi \setminus 90^\circ) = i \sinh \varphi$

**Jacobi's Zeta Function**

- 17.4.27  $Z(\varphi \setminus \alpha) = E(\varphi \setminus \alpha) - E(\alpha)F(\varphi \setminus \alpha)/K(\alpha)$
- 17.4.28  $Z(u|m) = Z(u) = E(u) - uE(m)/K(m)$
- 17.4.29  $Z(-u) = -Z(u)$
- 17.4.30  $Z(u + 2K) = Z(u)$
- 17.4.31  $Z(K - u) = -Z(K + u)$
- 17.4.32  $Z(u) = Z(u - K) - m \operatorname{sn}(u - K) \operatorname{cd}(u - K)$

**Special Values**

- 17.4.33  $Z(u|0) = 0$
- 17.4.34  $Z(u|1) = \tanh u$

**Addition Theorem**

- 17.4.35  $Z(u + v) = Z(u) + Z(v) - m \operatorname{sn} u \operatorname{sn} v \operatorname{sn}(u + v)$

**Jacobi's Imaginary Transformation**

- 17.4.36  $iZ(iu|m) = Z(u|m_1) + \frac{\pi u}{2KK'} - \operatorname{dn}(u|m_1) \operatorname{sc}(u|m_1)$

**Relation to Jacobi's Theta Function**

- 17.4.37  $Z(u) = \Theta'(u)/\Theta(u) = \frac{d}{du} \ln \Theta(u)$

**q-Series**

- 17.4.38  $Z(u) = \frac{2\pi}{K} \sum_{s=1}^{\infty} q^s (1 - q^{2s})^{-1} \sin(\pi s u / K)$

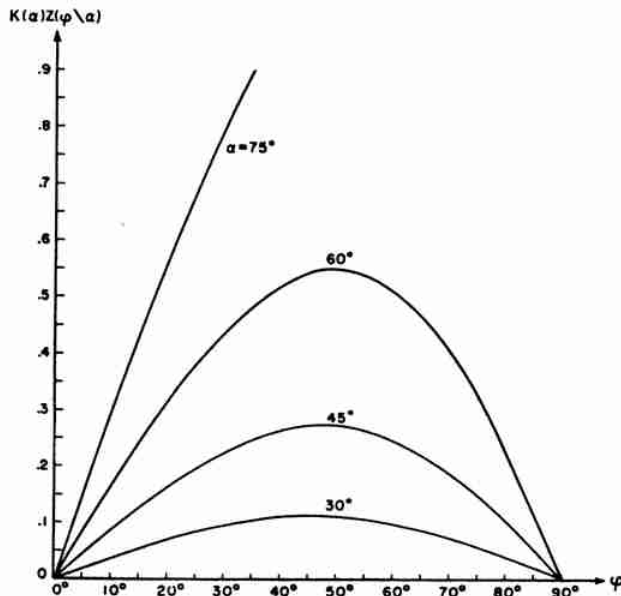

FIGURE 17.9. *Jacobian zeta function  $K(\alpha)Z(\varphi \setminus \alpha)$ .*

\*See page II.

**Heuman's Lambda Function**

- 17.4.39  $\Lambda_0(\varphi \setminus \alpha) = \frac{F(\varphi \setminus 90^\circ - \alpha)}{K'(\alpha)} + \frac{2}{\pi} K(\alpha) Z(\varphi \setminus 90^\circ - \alpha)$
- 17.4.40  $= \frac{2}{\pi} \{ K(\alpha) E(\varphi \setminus 90^\circ - \alpha) - [K(\alpha) - E(\alpha)] F(\varphi \setminus 90^\circ - \alpha) \}$

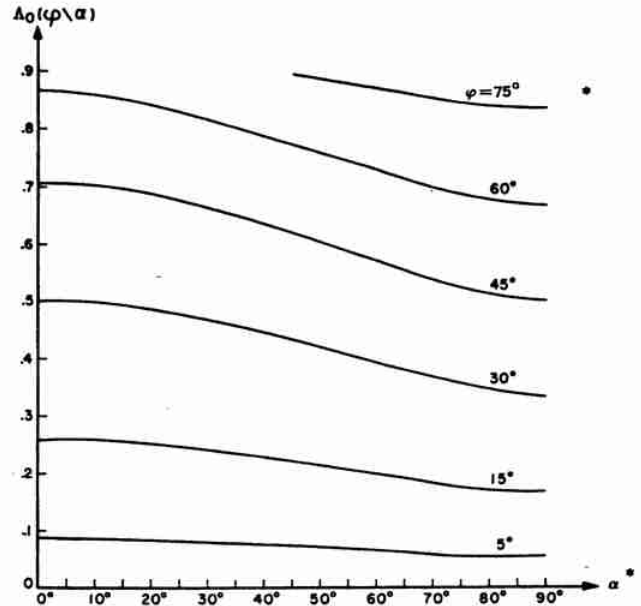

FIGURE 17.10. *Heuman's lambda function  $\Lambda_0(\varphi \setminus \alpha)$ .*

**Numerical Evaluation of Incomplete Integrals of the First and Second Kinds**

For the numerical evaluation of an elliptic integral the quartic (or cubic <sup>4</sup>) under the radical should first be expressed in terms of  $t^2$ , see **Examples 1 and 2**. In the resulting quartic there are only six possible sign patterns or combinations of the factors namely

$$(t^2 + a^2)(t^2 + b^2), (a^2 - t^2)(t^2 - b^2), (a^2 - t^2)(b^2 - t^2), (t^2 - a^2)(t^2 - b^2), (t^2 + a^2)(t^2 - b^2), (t^2 + a^2)(b^2 - t^2).$$

The list which follows is then exhaustive for integrals which reduce to  $F(\varphi \setminus \alpha)$  or  $E(\varphi \setminus \alpha)$ .

The value of the elliptic integral of the first kind is also expressed as an *inverse* Jacobian elliptic function. Here, for example, the notation  $u = \operatorname{sn}^{-1} x$  means that  $x = \operatorname{sn} u$ .

The column headed "t substitution" gives the Jacobian elliptic function substitution which is appropriate to reduce every elliptic integral which contains the given quartic.

<sup>4</sup> For an alternate treatment of cubics see 17.4.61 and 17.4.70.

|   | $F(\varphi \setminus \alpha)$  | Equivalent Inverse<br>Jacobian Elliptic<br>Function  | $\varphi$  | $t$ Substitution                                       | $E(\varphi \setminus \alpha)$   |
|---|--|--|--|--|---|
| $\cos \alpha = b/a$<br>$a > b$<br>$m = (a^2 - b^2)/a^2$ | 17.4.41<br>$a \int_0^x \frac{dt}{[(t^2 + a^2)(t^2 + b^2)]^{1/2}}$                      | $\operatorname{sc}^{-1} \left( \frac{x}{b} \middle  \frac{a^2 - b^2}{a^2} \right)$                   | $\tan \varphi = \frac{x}{b}$                             | $t = b \operatorname{sc} v$                            | $\frac{b^2}{a} \int_0^x \frac{(t^2 + a^2)}{(t^2 + b^2)} \frac{dt}{[(t^2 + a^2)(t^2 + b^2)]^{1/2}}$            |
|   | 17.4.42<br>$a \int_x^\infty \frac{dt}{[(t^2 + a^2)(t^2 + b^2)]^{1/2}}$                 | $\operatorname{cs}^{-1} \left( \frac{x}{a} \middle  \frac{a^2 - b^2}{a^2} \right)$                   | $\tan \varphi = \frac{a}{x}$                             | $t = a \operatorname{cs} v$                            | $a \int_x^\infty \frac{(t^2 + b^2)}{(t^2 + a^2)} \frac{dt}{[(t^2 + a^2)(t^2 + b^2)]^{1/2}}$                   |
|   | 17.4.43<br>$a \int_b^x \frac{dt}{[(a^2 - t^2)(t^2 - b^2)]^{1/2}}$                      | $\operatorname{nd}^{-1} \left( \frac{x}{b} \middle  \frac{a^2 - b^2}{a^2} \right)$                   | $\sin^2 \varphi = \frac{a^2(x^2 - b^2)}{x^2(a^2 - b^2)}$ | $t = b \operatorname{nd} v$                            | $ab^2 \int_b^x \frac{1}{t^2} \frac{dt}{[(a^2 - t^2)(t^2 - b^2)]^{1/2}}$                                       |
|   | 17.4.44<br>$a \int_x^a \frac{dt}{[(a^2 - t^2)(t^2 - b^2)]^{1/2}}$                      | $\operatorname{dn}^{-1} \left( \frac{x}{a} \middle  \frac{a^2 - b^2}{a^2} \right)$                   | $\sin^2 \varphi = \frac{a^2 - x^2}{a^2 - b^2}$           | $t = a \operatorname{dn} v$                            | $\frac{1}{a} \int_x^a \frac{t^2 dt}{[(a^2 - t^2)(t^2 - b^2)]^{1/2}}$  |
|   | 17.4.45<br>$a \int_0^x \frac{dt}{[(a^2 - t^2)(b^2 - t^2)]^{1/2}}$                      | $\operatorname{sn}^{-1} \left( \frac{x}{b} \middle  \frac{b^2}{a^2} \right)$                         | $\sin \varphi = \frac{x}{b}$                             | $t = b \operatorname{sn} v$                            | $\frac{1}{a} \int_0^x \frac{(a^2 - t^2) dt}{[(a^2 - t^2)(b^2 - t^2)]^{1/2}}$                                  |
| $\sin \alpha = b/a$<br>$a > b$<br>$m = b^2/a^2$         | 17.4.46<br>$a \int_x^b \frac{dt}{[(a^2 - t^2)(b^2 - t^2)]^{1/2}}$                      | $\operatorname{cd}^{-1} \left( \frac{x}{b} \middle  \frac{b^2}{a^2} \right)$                         | $\sin^2 \varphi = \frac{a^2(b^2 - x^2)}{b^2(a^2 - x^2)}$ | $t = b \operatorname{cd} v$                            | $a(a^2 - b^2) \int_x^b \left( \frac{1}{a^2 - t^2} \right) \frac{dt}{[(a^2 - t^2)(b^2 - t^2)]^{1/2}}$          |
|   | 17.4.47<br>$a \int_a^x \frac{dt}{[(t^2 - a^2)(t^2 - b^2)]^{1/2}}$                      | $\operatorname{dc}^{-1} \left( \frac{x}{a} \middle  \frac{b^2}{a^2} \right)$                         | $\sin^2 \varphi = \frac{x^2 - a^2}{x^2 - b^2}$           | $t = a \operatorname{dc} v$                            | $\frac{a^2 - b^2}{a} \int_a^x \left( \frac{t^2}{t^2 - b^2} \right) \frac{dt}{[(t^2 - a^2)(t^2 - b^2)]^{1/2}}$ |
|   | 17.4.48<br>$a \int_x^\infty \frac{dt}{[(t^2 - a^2)(t^2 - b^2)]^{1/2}}$                 | $\operatorname{ns}^{-1} \left( \frac{x}{a} \middle  \frac{b^2}{a^2} \right)$                         | $\sin \varphi = \frac{a}{x}$                             | $t = a \operatorname{ns} v$                            | $a \int_x^\infty \left( \frac{t^2 - b^2}{t^2} \right) \frac{dt}{[(t^2 - a^2)(t^2 - b^2)]^{1/2}}$              |
| $\cot \alpha = \frac{b}{a}$<br>$m = a^2/(a^2 + b^2)$    | 17.4.49<br>$(a^2 + b^2)^{1/2} \int_b^x \frac{dt}{[(t^2 + a^2)(t^2 - b^2)]^{1/2}}$      | $\operatorname{nc}^{-1} \left( \frac{x}{b} \middle  \frac{a^2}{a^2 + b^2} \right)$                   | $\cos \varphi = \frac{b}{x}$                             | $t = b \operatorname{nc} v$                            | $\frac{b^2}{(a^2 + b^2)^{1/2}} \int_b^x \frac{t^2 + a^2}{t^2} \frac{dt}{[(t^2 + a^2)(t^2 - b^2)]^{1/2}}$      |
|   | 17.4.50<br>$(a^2 + b^2)^{1/2} \int_x^\infty \frac{dt}{[(t^2 + a^2)(t^2 - b^2)]^{1/2}}$ | $\operatorname{ds}^{-1} \left( \frac{x}{(a^2 + b^2)^{1/2}} \middle  \frac{a^2}{a^2 + b^2} \right)$   | $\sin^2 \varphi = \frac{a^2 + b^2}{a^2 + x^2}$           | $t = (a^2 + b^2)^{1/2} \operatorname{ds} v$            | $(a^2 + b^2)^{1/2} \int_x^\infty \frac{t^2}{(t^2 + a^2)} \frac{dt}{[(t^2 + a^2)(t^2 - b^2)]^{1/2}}$           |
| $\tan \alpha = \frac{b}{a}$<br>$m = b^2/(a^2 + b^2)$    | 17.4.51<br>$(a^2 + b^2)^{1/2} \int_0^x \frac{dt}{[(t^2 + a^2)(b^2 - t^2)]^{1/2}}$      | $\operatorname{sd}^{-1} \left( \frac{x(a^2 + b^2)^{1/2}}{ab} \middle  \frac{b^2}{a^2 + b^2} \right)$ | $\sin^2 \varphi = \frac{x^2(a^2 + b^2)}{b^2(a^2 + x^2)}$ | $t = \frac{ab}{(a^2 + b^2)^{1/2}} \operatorname{sd} v$ | $a^2(a^2 + b^2)^{1/2} \int_0^x \frac{1}{(t^2 + a^2)} \frac{dt}{[(t^2 + a^2)(b^2 - t^2)]^{1/2}}$               |
|   | 17.4.52<br>$(a^2 + b^2)^{1/2} \int_x^b \frac{dt}{[(t^2 + a^2)(b^2 - t^2)]^{1/2}}$      | $\operatorname{cn}^{-1} \left( \frac{x}{b} \middle  \frac{b^2}{a^2 + b^2} \right)$                   | $\cos \varphi = \frac{x}{b}$                             | $t = b \operatorname{cn} v$                            | $\frac{1}{(a^2 + b^2)^{1/2}} \int_x^b \frac{(t^2 + a^2) dt}{[(t^2 + a^2)(b^2 - t^2)]^{1/2}}$                  |

Some Important Special Cases

| $\frac{1}{2}F(\varphi \setminus \alpha)$                           | $\cos \varphi$        | $\alpha$ | $\frac{1}{3^{1/4}}F(\varphi \setminus \alpha)$             | $\cos \varphi$                      | $\alpha$ |
|--|-----------------------|----------|--|-------------------------------------|----------|
| 17.4.53<br>$\int_x^\infty \frac{dt}{(1+t^2)^{1/2}}$                | $\frac{x^2-1}{x^2+1}$ | 45°      | 17.4.57<br>$\int_x^\infty \frac{dt}{(\beta^2-1)^{1/2}}$    | $\frac{x-1-\sqrt{3}}{x-1+\sqrt{3}}$ | 15°      |
| 17.4.54<br>$\int_0^x \frac{dt}{(1+t^2)^{1/2}}$                     | $\frac{1-x^2}{1+x^2}$ | 45°      | 17.4.58<br>$\int_1^x \frac{dt}{(\beta^2-1)^{1/2}}$         | $\frac{\sqrt{3}+1-x}{\sqrt{3}-1+x}$ | 15°      |
| * 17.4.55<br>$\frac{1}{2^{1/2}} \int_1^x \frac{dt}{(t^2-1)^{1/2}}$ | $\frac{1}{x}$         | 45°      | 17.4.59<br>$\int_x^1 \frac{dt}{(1-\beta^2)^{1/2}}$         | $\frac{\sqrt{3}-1+x}{\sqrt{3}+1-x}$ | 75°      |
| * 17.4.56<br>$\frac{1}{2^{1/2}} \int_x^1 \frac{dt}{(1-t^2)^{1/2}}$ | $x$                   | 45°      | 17.4.60<br>$\int_{-\infty}^x \frac{dt}{(1-\beta^2)^{1/2}}$ | $\frac{1-\sqrt{3}-x}{1+\sqrt{3}-x}$ | 75°      |

Reduction of  $\int dt/\sqrt{P}$  where  $P=P(t)$  is a cubic polynomial with three real factors  $P=(t-\beta_1)(t-\beta_2)(t-\beta_3)$  where  $\beta_1 > \beta_2 > \beta_3$ . Write

17.4.61

$$\lambda = \frac{1}{2} (\beta_1 - \beta_3)^{1/2}, \quad m = \sin^2 \alpha = \frac{\beta_2 - \beta_3}{\beta_1 - \beta_3},$$

$$m_1 = \cos^2 \alpha = \frac{\beta_1 - \beta_2}{\beta_1 - \beta_3}$$

17.4.62

$$\lambda \int_{\beta_3}^x \frac{dt}{\sqrt{P}} \quad F(\varphi \setminus \alpha) \quad \sin^2 \varphi = \frac{x - \beta_3}{\beta_2 - \beta_3}$$

17.4.63

$$\lambda \int_x^{\beta_2} \frac{dt}{\sqrt{P}} \quad F(\varphi \setminus \alpha) \quad \cos^2 \varphi = \frac{(\beta_1 - \beta_2)(x - \beta_3)}{(\beta_2 - \beta_3)(\beta_1 - x)}$$

17.4.64

$$\lambda \int_{\beta_1}^x \frac{dt}{\sqrt{P}} \quad F(\varphi \setminus \alpha) \quad \sin^2 \varphi = \frac{x - \beta_1}{x - \beta_2}$$

17.4.65

$$\lambda \int_x^\infty \frac{dt}{\sqrt{P}} \quad F(\varphi \setminus \alpha) \quad \cos^2 \varphi = \frac{x - \beta_1}{x - \beta_2}$$

17.4.66

$$\lambda \int_{-\infty}^x \frac{dt}{\sqrt{-P}} \quad F(\varphi \setminus (90^\circ - \alpha^\circ)) \quad \sin^2 \varphi = \frac{\beta_1 - \beta_3}{\beta_1 - x}$$

17.4.67

$$\lambda \int_x^{\beta_3} \frac{dt}{\sqrt{-P}} \quad F(\varphi \setminus (90^\circ - \alpha^\circ)) \quad \cos^2 \varphi = \frac{\beta_2 - \beta_3}{\beta_2 - x}$$

17.4.68

$$\lambda \int_{\beta_2}^x \frac{dt}{\sqrt{-P}} \quad F(\varphi \setminus (90^\circ - \alpha^\circ)) \quad \sin^2 \varphi = \frac{(\beta_1 - \beta_2)(x - \beta_2)}{(\beta_1 - \beta_2)(x - \beta_3)}$$

17.4.69

$$\lambda \int_x^{\beta_1} \frac{dt}{\sqrt{-P}} \quad F(\varphi \setminus (90^\circ - \alpha^\circ)) \quad \cos^2 \varphi = \frac{x - \beta_2}{\beta_1 - \beta_2}$$

Reduction of  $\int dt/\sqrt{P}$  when  $P=P(t)=t^3+a_1t^2+a_2t+a_3$  is a cubic polynomial with only one real root  $t=\beta$ . We form the first and second derivatives  $P'(t), P''(t)$  with respect to  $t$  and then write

17.4.70  $\lambda^2 = [P'(\beta)]^{1/2}, m = \sin^2 \alpha = \frac{1}{2} \frac{1}{8} \frac{P''(\beta)}{[P'(\beta)]^{3/2}}$

17.4.71

$$\lambda \int_{\beta}^x \frac{dt}{\sqrt{P}} \quad F(\varphi \setminus \alpha) \quad \cos \varphi = \frac{\lambda^2 - (x - \beta)}{\lambda^2 + (x - \beta)}$$

17.4.72

$$\lambda \int_x^\infty \frac{dt}{\sqrt{P}} \quad F(\varphi \setminus \alpha) \quad \cos \varphi = \frac{(x - \beta) - \lambda^2}{(x - \beta) + \lambda^2}$$

17.4.73

$$\lambda \int_{-\infty}^x \frac{dt}{\sqrt{(-P)}} \quad F(\varphi \setminus (90^\circ - \alpha^\circ)) \quad \cos \varphi = \frac{(\beta - x) - \lambda^2}{(\beta - x) + \lambda^2}$$

17.4.74

$$\lambda \int_x^{\beta} \frac{dt}{\sqrt{(-P)}} \quad F(\varphi \setminus (90^\circ - \alpha^\circ)) \quad \cos \varphi = \frac{\lambda^2 - (\beta - x)}{\lambda^2 + (\beta - x)}$$

17.5. Landen's Transformation

Descending Landen Transformation <sup>5</sup>

Let  $\alpha_n, \alpha_{n+1}$  be two modular angles such that

17.5.1  $(1 + \sin \alpha_{n+1})(1 + \cos \alpha_n) = 2 \quad (\alpha_{n+1} < \alpha_n)$

and let  $\varphi_n, \varphi_{n+1}$  be two corresponding amplitudes such that

17.5.2  $\tan(\varphi_{n+1} - \varphi_n) = \cos \alpha_n \tan \varphi_n \quad (\varphi_{n+1} > \varphi_n)$

<sup>5</sup> The emphasis here is on the modular angle since this is an argument of the Tables. All formulae concerning Landen's transformation may also be expressed in terms of the modulus  $k = m^{\frac{1}{2}} = \sin \alpha$  and its complement  $k' = m^{\frac{1}{2}} = \cos \alpha$ .

\*See page 11.

Thus the step from  $n$  to  $n+1$  decreases the modular angle but increases the amplitude. By iterating the process we can descend from a given modular angle to one whose magnitude is negligible, when 17.4.19 becomes applicable.

With  $\alpha_0 = \alpha$  we have

17.5.3

$$F(\varphi \setminus \alpha) = (1 + \cos \alpha)^{-1} F(\varphi_1 \setminus \alpha_1) \\ = \frac{1}{2} (1 + \sin \alpha_1) F(\varphi_1 \setminus \alpha_1)$$

17.5.4  $F(\varphi \setminus \alpha) = 2^{-n} \prod_{s=1}^n (1 + \sin \alpha_s) F(\varphi_n \setminus \alpha_n)$

17.5.5  $F(\varphi \setminus \alpha) = \Phi \prod_{s=1}^{\infty} (1 + \sin \alpha_s)$

17.5.6  $\Phi = \lim_{n \rightarrow \infty} \frac{1}{2^n} F(\varphi_n \setminus \alpha_n) = \lim_{n \rightarrow \infty} \frac{\varphi_n}{2^n}$

17.5.7  $K = F(\frac{1}{2}\pi \setminus \alpha) = \frac{1}{2}\pi \prod_{s=1}^{\infty} (1 + \sin \alpha_s)$

17.5.8  $F(\varphi \setminus \alpha) = 2\pi^{-1} K \Phi$

17.5.9

$$E(\varphi \setminus \alpha) = F(\varphi \setminus \alpha) \left[ 1 - \frac{1}{2} \sin^2 \alpha \left( 1 + \frac{1}{2} \sin \alpha_1 \right. \right. \\ \left. \left. + \frac{1}{2^2} \sin \alpha_1 \sin \alpha_2 + \dots \right) \right] + \sin \alpha \left[ \frac{1}{2} (\sin \alpha_1)^{1/2} \sin \varphi_1 \right. \\ \left. + \frac{1}{2^2} (\sin \alpha_1 \sin \alpha_2)^{1/2} \sin \varphi_2 + \dots \right]$$

17.5.10

$$E = K \left[ 1 - \frac{1}{2} \sin^2 \alpha \left( 1 + \frac{1}{2} \sin \alpha_1 + \frac{1}{2^2} \sin \alpha_1 \sin \alpha_2 \right. \right. \\ \left. \left. + \frac{1}{2^3} \sin \alpha_1 \sin \alpha_2 \sin \alpha_3 + \dots \right) \right]$$

Ascending Landen Transformation

Let  $\alpha_n, \alpha_{n+1}$  be two modular angles such that

17.5.11  $(1 + \sin \alpha_n)(1 + \cos \alpha_{n+1}) = 2 \quad (\alpha_{n+1} > \alpha_n)$

and let  $\varphi_n, \varphi_{n+1}$  be two corresponding amplitudes such that

17.5.12  $\sin(2\varphi_{n+1} - \varphi_n) = \sin \alpha_n \sin \varphi_n \quad (\varphi_{n+1} < \varphi_n)$

Thus the step from  $n$  to  $n+1$  increases the modular angle but decreases the amplitude. By iterating the process we can ascend from a given modular angle to one whose difference from a right angle is so small that 17.4.21 becomes applicable.

With  $\alpha_0 = \alpha$  we have

17.5.13  $F(\varphi \setminus \alpha) = 2(1 + \sin \alpha)^{-1} F(\varphi_1 \setminus \alpha_1)$

17.5.14  $F(\varphi \setminus \alpha) = 2^n \prod_{s=0}^{n-1} (1 + \sin \alpha_s)^{-1} F(\varphi_n \setminus \alpha_n)$

17.5.15  $F(\varphi \setminus \alpha) = \prod_{s=1}^n (1 + \cos \alpha_s) F(\varphi_n \setminus \alpha_n)$

17.5.16  $F(\varphi \setminus \alpha) = [\csc \alpha \prod_{s=1}^{\infty} \sin \alpha_s]^{\frac{1}{2}} \ln \tan \left( \frac{1}{4} \pi + \frac{1}{2} \Phi \right)$

17.5.17  $\Phi = \lim_{n \rightarrow \infty} \varphi_n$

Neighborhood of a Right Angle (see also 17.4.13)

When both  $\varphi$  and  $\alpha$  are near to a right angle, interpolation in the table  $F(\varphi \setminus \alpha)$  is difficult. Either Landen's transformation can then be used with advantage to increase the modular angle and decrease the amplitude or vice-versa.

17.6. The Process of the Arithmetic-Geometric Mean

Starting with a given number triple  $(a_0, b_0, c_0)$  we proceed to determine number triples  $(a_1, b_1, c_1), (a_2, b_2, c_2), \dots, (a_N, b_N, c_N)$  according to the following scheme of arithmetic and geometric means

17.6.1

|  |   |  |
|--|---|--|
| $a_0$                                  | $b_0$                                   |  |
| $a_1 = \frac{1}{2}(a_0 + b_0)$         | $b_1 = (a_0 b_0)^{\frac{1}{2}}$         |  |
| $a_2 = \frac{1}{2}(a_1 + b_1)$         | $b_2 = (a_1 b_1)^{\frac{1}{2}}$         |  |
| $\vdots$                               | $\vdots$                                |  |
| $a_N = \frac{1}{2}(a_{N-1} + b_{N-1})$ | $b_N = (a_{N-1} b_{N-1})^{\frac{1}{2}}$ |  |
|  |   | $c_0$                                  |
|  |   | $c_1 = \frac{1}{2}(a_0 - b_0)$         |
|  |   | $c_2 = \frac{1}{2}(a_1 - b_1)$         |
|  |   | $\vdots$                               |
|  |   | $c_N = \frac{1}{2}(a_{N-1} - b_{N-1})$ |

We stop at the  $N$ th step when  $a_N = b_N$ , i.e., when  $c_N = 0$  to the degree of accuracy to which the numbers are required.

To determine the complete elliptic integrals  $K(\alpha), E(\alpha)$  we start with

17.6.2  $a_0 = 1, b_0 = \cos \alpha, c_0 = \sin \alpha$

whence

17.6.3  $K(\alpha) = \frac{\pi}{2a_N}$

17.6.4  $\frac{K(\alpha) - E(\alpha)}{K(\alpha)} = \frac{1}{2} [c_0^2 + 2c_1^2 + 2^2c_2^2 + \dots + 2^N c_N^2]$

To determine  $K'(\alpha)$ ,  $E'(\alpha)$  we start with

17.6.5  $a'_0 = 1, b'_0 = \sin \alpha, c'_0 = \cos \alpha$

whence

17.6.6  $K'(\alpha) = \frac{\pi}{2a'_N}$

17.6.7

$\frac{K'(\alpha) - E'(\alpha)}{K'(\alpha)} = \frac{1}{2} [c_0'^2 + 2c_1'^2 + 2^2c_2'^2 + \dots + 2^N c_N'^2]$

To calculate  $F(\varphi \setminus \alpha)$ ,  $E(\varphi \setminus \alpha)$  start from 17.5.2 which corresponds to the descending Landen transformation and determine  $\varphi_1, \varphi_2, \dots, \varphi_N$  successively from the relation

17.6.8  $\tan(\varphi_{n+1} - \varphi_n) = (b_n/a_n) \tan \varphi_n, \varphi_0 = \varphi$

Then to the prescribed accuracy

17.6.9  $F(\varphi \setminus \alpha) = \varphi_N / (2^N a_N) \quad *$

17.6.10

$Z(\varphi \setminus \alpha) = E(\varphi \setminus \alpha) - (E/K)F(\varphi \setminus \alpha)$

\*  $= c_1 \sin \varphi_1 + c_2 \sin \varphi_2 + \dots + c_N \sin \varphi_N$

17.7. Elliptic Integrals of the Third Kind

17.7.1

$\Pi(n; \varphi \setminus \alpha) = \int_0^\varphi (1 - n \sin^2 \theta)^{-1} (1 - \sin^2 \alpha \sin^2 \theta)^{-\frac{1}{2}} d\theta$

17.7.2  $\Pi(n; \frac{1}{2}\pi \setminus \alpha) = \Pi(n \setminus \alpha)$

Case (i) Hyperbolic Case  $0 < n < \sin^2 \alpha$

$\epsilon = \arcsin(n/\sin^2 \alpha)^{\frac{1}{2}}, \quad 0 \leq \epsilon \leq \frac{1}{2}\pi$

$\beta = \frac{1}{2}\pi F(\epsilon \setminus \alpha) / K(\alpha)$

$q = q(\alpha)$

$v = \frac{1}{2}\pi F(\varphi \setminus \alpha) / K(\alpha),$

$\delta_1 = [n(1-n)^{-1}(\sin^2 \alpha - n)^{-1}]^{\frac{1}{2}}$

17.7.3

$\Pi(n; \varphi \setminus \alpha) = \delta_1 [-\frac{1}{2} \ln [\vartheta_4(v+\beta)/\vartheta_4(v-\beta)] + v\vartheta_1'(\beta)/\vartheta_1(\beta)]$

17.7.4

$\frac{1}{2} \ln \frac{\vartheta_4(v+\beta)}{\vartheta_4(v-\beta)} = 2 \sum_{s=1}^{\infty} s^{-1} q^s (1 - q^{2s})^{-1} \sin 2sv \sin 2s\beta$

17.7.5

$\frac{\vartheta_1'(\beta)}{\vartheta_1(\beta)} = \cot \beta + 4 \sum_{s=1}^{\infty} q^{2s} (1 - 2q^{2s} \cos 2\beta + q^{4s})^{-1} \sin 2\beta$

In the above we can also use Neville's theta functions 16.36.

17.7.6  $\Pi(n \setminus \alpha) = K(\alpha) + \delta_1 K(\alpha) Z(\epsilon \setminus \alpha)$

Case (ii) Hyperbolic Case  $n > 1$

The case  $n > 1$  can be reduced to the case  $0 < N < \sin^2 \alpha$  by writing

17.7.7  $N = n^{-1} \sin^2 \alpha, p_1 = [(n-1)(1-n^{-1} \sin^2 \alpha)]^{\frac{1}{2}}$

17.7.8

$\Pi(n; \varphi \setminus \alpha) = -\Pi(N; \varphi \setminus \alpha) + F(\varphi \setminus \alpha) + \frac{1}{2p_1} \ln [(\Delta(\varphi) + p_1 \tan \varphi)(\Delta(\varphi) - p_1 \tan \varphi)^{-1}]$

where  $\Delta(\varphi)$  is the delta amplitude, 17.2.4.

17.7.9  $\Pi(n \setminus \alpha) = K(\alpha) - \Pi(N \setminus \alpha)$

Case (iii) Circular Case  $\sin^2 \alpha < n < 1$

$\epsilon = \arcsin [(1-n)/\cos^2 \alpha]^{\frac{1}{2}}, \quad 0 \leq \epsilon \leq \frac{1}{2}\pi$

$\beta = \frac{1}{2}\pi F(\epsilon \setminus 90^\circ - \alpha) / K(\alpha)$

$q = q(\alpha)$

17.7.10

$v = \frac{1}{2}\pi F(\varphi \setminus \alpha) / K(\alpha), \delta_2 = [n(1-n)^{-1}(n - \sin^2 \alpha)^{-1}]^{\frac{1}{2}}$

17.7.11  $\Pi(n; \varphi \setminus \alpha) = \delta_2 (\lambda - 4\mu v)$

17.7.12

$\lambda = \arctan(\tanh \beta \tan v) + 2 \sum_{s=1}^{\infty} (-1)^{s-1} s^{-1} q^{2s} (1 - q^{2s})^{-1} \sin 2sv \sinh 2s\beta$

17.7.13

$\mu = \left[ \sum_{s=1}^{\infty} s q^{2s} \sinh 2s\beta \right] \left[ 1 + 2 \sum_{s=1}^{\infty} q^{2s} \cosh 2s\beta \right]^{-1}$

17.7.14  $\Pi(n \setminus \alpha) = K(\alpha) + \frac{1}{2}\pi \delta_2 [1 - \Lambda_0(\epsilon \setminus \alpha)]$

where  $\Lambda_0$  is Heuman's Lambda function, 17.4.39.

\* See page II.



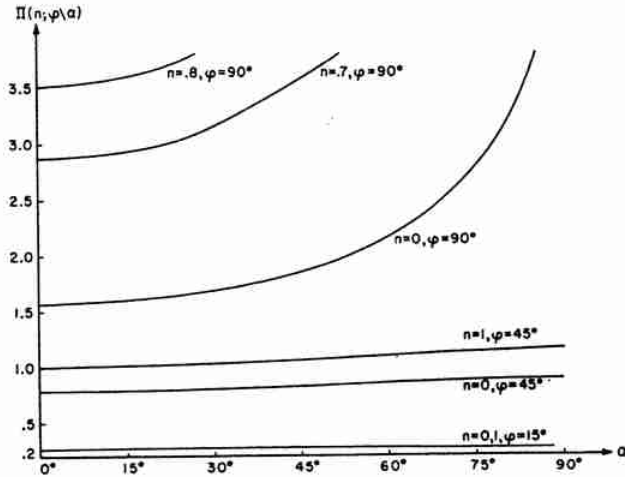

FIGURE 17.11. *Elliptic integral of the third kind*  $\Pi(n; \varphi|\alpha)$ .

**Case (iv) Circular Case  $n < 0$**

The case  $n < 0$  can be reduced to the case  $\sin^2 \alpha < N < 1$  by writing

**17.7.15**

$$N = (\sin^2 \alpha - n)(1 - n)^{-1}$$

$$p_2 = [-n(1 - n)^{-1}(\sin^2 \alpha - n)]^{\frac{1}{2}}$$

**17.7.16**

$$[(1 - n)(1 - n^{-1} \sin^2 \alpha)]^{\frac{1}{2}} \Pi(n; \varphi|\alpha)$$

$$= [(1 - N)(1 - N^{-1} \sin^2 \alpha)]^{\frac{1}{2}} \Pi(N; \varphi|\alpha)$$

$$+ p_2^{-1} \sin^2 \alpha F(\varphi|\alpha) + \arctan \left[ \frac{1}{2} p_2 \sin 2\varphi / \Delta(\varphi) \right]$$

**17.7.17**

$$\Pi(n|\alpha) = (-n \cos^2 \alpha)(1 - n)^{-1}(\sin^2 \alpha - n)^{-1} \Pi(N|\alpha)$$

$$+ \sin^2 \alpha (\sin^2 \alpha - n)^{-1} K(\alpha)$$

**Special Cases**

**17.7.18**

$$n = 0$$

$$\Pi(0; \varphi|\alpha) = F(\varphi|\alpha)$$

**17.7.19**

$$n = 0, \alpha = 0$$

$$\Pi(0; \varphi|0) = \varphi$$

**17.7.20**

$$\alpha = 0$$

$$\Pi(n; \varphi|0) = (1 - n)^{-\frac{1}{2}} \arctan [(1 - n)^{\frac{1}{2}} \tan \varphi], \quad n < 1$$

$$= (n - 1)^{-\frac{1}{2}} \operatorname{arctanh} [(n - 1)^{\frac{1}{2}} \tan \varphi], \quad n > 1$$

$$= \tan \varphi \quad n = 1$$

**17.7.21**

$$\alpha = \pi/2$$

$$\Pi(n; \varphi|\pi/2) = (1 - n)^{-1} [\ln (\tan \varphi + \sec \varphi)$$

$$- \frac{1}{2} n^{\frac{1}{2}} \ln (1 + n^{\frac{1}{2}} \sin \varphi)(1 - n^{\frac{1}{2}} \sin \varphi)^{-1}] \quad n \neq 1$$

**17.7.22**

$$n = \pm \sin \alpha$$

$$(1 \mp \sin \alpha) \{ 2\Pi(\pm \sin \alpha; \varphi|\alpha) - F(\varphi|\alpha) \}$$

$$= \arctan [(1 \mp \sin \alpha) \tan \varphi / \Delta(\varphi)]$$

**17.7.23**

$$n = 1 \pm \cos \alpha$$

$$2 \cos \alpha \Pi(1 \pm \cos \alpha; \varphi|\alpha) = \pm \frac{1}{2} \ln [(1 + \tan \varphi$$

$$\cdot \Delta(\varphi))(1 - \tan \varphi \cdot \Delta(\varphi))^{-1}] + \frac{1}{2} \ln [(\Delta(\varphi)$$

$$+ \cos \alpha \cdot \tan \varphi)(\Delta(\varphi) - \cos \alpha \tan \varphi)^{-1}]$$

$$\mp (1 \mp \cos \alpha) F(\varphi|\alpha)$$

**17.7.24**

$$n = \sin^2 \alpha$$

$$\Pi(\sin^2 \alpha; \varphi|\alpha) = \sec^2 \alpha E(\varphi|\alpha) - (\tan^2 \alpha \sin 2\varphi) / (2\Delta(\varphi))$$

**17.7.25**

$$n = 1$$

$$\Pi(1; \varphi|\alpha) = F(\varphi|\alpha) - \sec^2 \alpha E(\varphi|\alpha) + \sec^2 \alpha \tan \varphi \Delta(\varphi)$$

**Numerical Methods**

**17.8. Use and Extension of the Tables**

**Example 1.** Reduce to canonical form  $\int y^{-1} dx$ , where

$$y^2 = -3x^4 + 34x^3 - 119x^2 + 172x - 90$$

By inspection or by solving an equation of the fourth degree we find that

$$y^2 = Q_1 Q_2 \text{ where } Q_1 = 3x^2 - 10x + 9, Q_2 = -x^2 + 8x - 10$$

**First Method**

$Q_1 - \lambda Q_2 = (3 + \lambda)x^2 - (10 + 8\lambda)x + 9 + 10\lambda$  is a perfect square if the discriminant

$$(10 + 8\lambda)^2 - 4(3 + \lambda)(9 + 10\lambda) = 0; \text{ i.e., if } \lambda = -\frac{2}{3} \text{ or } \frac{1}{2}$$

and then

$$Q_1 + \frac{2}{3} Q_2 = \frac{7}{3} (x - 1)^2, Q_1 - \frac{1}{2} Q_2 = \frac{7}{2} (x - 2)^2$$

Solving for  $Q_1$  and  $Q_2$  we get

$$Q_1 = (x - 1)^2 + 2(x - 2)^2, Q_2 = 2(x - 1)^2 - 3(x - 2)^2$$

The substitution  $t = (x - 1)/(x - 2)$  then gives

$$\int y^{-1} dx = \pm \int [(t^2 + 2)(2t^2 - 3)]^{-\frac{1}{2}} dt$$

\*See page II.

If the quartic  $y^2=0$  has four real roots in  $x$  (or in the case of a cubic all three roots are real), we must so combine the factors that no root of  $Q_1=0$  lies between the roots of  $Q_2=0$  and no root of  $Q_2=0$  lies between the roots of  $Q_1=0$ . Provided this condition is observed the method just described will always lead to real values of  $\lambda$ . These values may, however, be irrational.

**Second Method**

Write

$$t^2 = \frac{Q_1}{Q_2} = \frac{3x^2 - 10x + 9}{-x^2 + 8x - 10}$$

and let the discriminant of  $Q_2t^2 - Q_1$  be

$$4T^2 = (8t^2 + 10)^2 - 4(t^2 + 3)(10t^2 + 9) \\ = 4(3t^2 + 2)(2t^2 - 1)$$

Then

$$\int y^{-1} dx = \pm \int T^{-1} dt = \pm \int [(3t^2 + 2)(2t^2 - 1)]^{-1/2} dt$$

This method will succeed if, as here,  $T^2$  as a function of  $t^2$  has real factors. If the coefficients of the given quartic are rational numbers, the factors of  $T^2$  will likewise be rational.

**Third Method**

Write

$$w = \frac{Q_1}{Q_2} = \frac{3x^2 - 10x + 9}{-x^2 + 8x - 10}$$

and let the discriminant of  $Q_2w - Q_1$  be

$$4W = 4(3w + 2)(2w - 1) = 4(Aw^2 + Bw + C)$$

Then if

$$z^2 = W/w \text{ and } Z^2 = (B - z^2)^2 - 4AC = (z^2 - 1)^2 + 48$$

$$\int y^{-1} dx = \pm \int Z^{-1} dz$$

However, in this case the factors of  $Z$  are complex and the method fails.

Of the second and third methods one will always succeed where the other fails, and if the coefficients of the given quartic are rational numbers, the factors of  $T^2$  or  $Z^2$ , as the case may be, will be rational.

**Example 2.** Reduce to canonical form  $\int y^{-1} dx$  where  $y^2 = x(x-1)(x-2)$ .

We use the third method of **Example 1** taking  $Q_1 = (x-1)$ ,  $Q_2 = x(x-2)$  and writing

$$w = \frac{Q_1}{Q_2} = \frac{x-1}{x^2-2x}$$

The discriminant of  $Q_2w - Q_1 = x^2w - (2w+1)x + 1$  is

$$4W = (2w+1)^2 - 4w = 4w^2 + 1$$

so that

$$W = Aw^2 + Bw + C \text{ where } A=1, B=0, C=\frac{1}{4}$$

and if we write  $z^2 = W/w$  and

$$Z^2 = (B - z^2)^2 - 4AC = (z^2)^2 - 1 = (z^2 - 1)(z^2 + 1),$$

$$\int y^{-1} dx = \pm \int [(z^2 - 1)(z^2 + 1)]^{-1/2} dz$$

The first method of **Example 1** fails with the above values of  $Q_1$  and  $Q_2$  since the root of  $Q_1=0$  lies between the roots of  $Q_2=0$ , and we get imaginary values of  $\lambda$ . The method succeeds, however, if we take  $Q_1 = x$ ,  $Q_2 = (x-1)(x-2)$ , for then the roots of  $Q_1=0$  do not lie between those of  $Q_2=0$ .

**Example 3.** Find  $K(80/81)$ .

**First Method**

Use 17.3.29 with  $m=80/81$ ,  $m_1=1/81$ ,  $m_1^{1/2}=1/9$ . Since  $[(1 - m_1^{1/2})(1 + m_1^{1/2})^{-1}]^2 = .64$ ,  $K(80/81) = 1.8 K(.64) = 3.59154 500$  to 8D, taking  $K(.64)$  from **Table 17.1**.

**Second Method**

**Table 17.4** giving  $L(m)$  is useful for computing  $K(m)$  when  $m$  is near unity or  $K'(m)$  when  $m$  is near zero.

$$K(80/81) = \frac{1}{\pi} K'(80/81) \ln(16 \times 81) - L(80/81).$$

By interpolation in **Tables 17.1** and **17.4**, since  $80/81 = .98765 43210$ ,

$$K'(80/81) = 1.57567 8423$$

$$L(80/81) = .00311 16543$$

$$K(80/81) = \pi^{-1}(1.57567 8423)(7.16703 7877)$$

$$-.00311 16543$$

$$= 3.59154 5000 \text{ to } 9D.$$

**Third Method**

The polynomial approximation 17.3.34 gives to 8D

$$K(80/81) = 3.59154 501$$

**Fourth Method, Arithmetic-Geometric Mean**

Here  $\sin^2 \alpha = 80/81$  and we start with

$$a_0 = 1, b_0 = \frac{1}{9}, c_0 = \sqrt{80/81} = .99380 79900$$

giving

$$\begin{aligned}\epsilon &= \arcsin [(1-n)/\cos^2 \alpha]^{\frac{1}{2}} = 45^\circ \\ \beta &= \frac{1}{2}\pi F(45^\circ \setminus 60^\circ)/K(30^\circ) = .79317\ 74 \\ v &= \frac{1}{2}\pi F(45^\circ \setminus 30^\circ)/K(30^\circ) = .74951\ 51 \\ \delta_2 &= (40/9)^{\frac{1}{2}} \\ q &= .01797\ 24\end{aligned}$$

and so from 17.7.11

$$\begin{aligned}\Pi\left(\frac{5}{8}; 45^\circ \setminus 30^\circ\right) &= (40/9)^{1/2}(\lambda - 4\mu v) \\ &= 2.10818\ 51\{.55248\ 32 - 4(.03854\ 26) \\ &\quad (.74951\ 51)\} = .921129.\end{aligned}$$

Table 17.9 gives .92113 with 4 point Lagrangian interpolation.

**Example 18.** Evaluate the complete elliptic integral

$$\Pi\left(\frac{5}{8} \setminus 30^\circ\right) \text{ to } 5D.$$

From 17.7.14 we have

$$\Pi\left(\frac{5}{8} \setminus 30^\circ\right) = K(30^\circ) + \frac{\pi}{2} \sqrt{\frac{40}{9}} [1 - \Lambda_0(\epsilon \setminus 30^\circ)]$$

where  $\epsilon = \arcsin [(1-n)/\cos^2 \alpha]^{\frac{1}{2}} = 45^\circ$ . Thus using Table 17.8

$$\Pi\left(\frac{5}{8} \setminus 30^\circ\right) = 2.80099.$$

Table 17.9 gives 2.80126 by 6 point Lagrangian interpolation. The discrepancy results from interpolation with respect to  $n$  for  $\varphi = 90^\circ$  in Table 17.9.

**Example 19.** Evaluate

$$\begin{aligned}\Pi\left(\frac{5}{8}; 45^\circ \setminus 30^\circ\right) \\ = \int_0^{\pi/4} (1 - \frac{5}{8} \sin^2 \theta)^{-1} (1 - \frac{1}{4} \sin^2 \theta)^{-1/2} d\theta\end{aligned}$$

to 5D.

Here  $n = \frac{5}{4}$ ,  $\varphi = 45^\circ$ ,  $\alpha = 30^\circ$  and since the characteristic is greater than unity we use 17.7.7

$$\begin{aligned}N &= n^{-1} \sin^2 \alpha = .2, \quad p_1 = (1/5)^{\frac{1}{2}} \\ \Pi\left(\frac{5}{8}; 45^\circ \setminus 30^\circ\right) &= -\Pi(2; 45^\circ \setminus 30^\circ) + F(45^\circ \setminus 30^\circ) \\ &\quad + (\frac{1}{2}\sqrt{5}) \ln \frac{(7/8)^{\frac{1}{2}} + (1/5)^{\frac{1}{2}}}{(7/8)^{\frac{1}{2}} - (1/5)^{\frac{1}{2}}} \\ &= -.83612 + .80437 \\ &\quad + \frac{1}{2}\sqrt{5} \ln \frac{\sqrt{35} + \sqrt{8}}{\sqrt{35} - \sqrt{8}} \\ &= 1.13214.\end{aligned}$$

Numerical quadrature gives the same result.

**Example 20.** Evaluate

$$\begin{aligned}\Pi\left(-\frac{1}{4}; 45^\circ \setminus 30^\circ\right) \\ = \int_0^{\pi/4} (1 + \frac{1}{4} \sin^2 \theta)^{-1} (1 - \frac{1}{4} \sin^2 \theta)^{-\frac{1}{2}} d\theta\end{aligned}$$

to 5D.

Here the characteristic is negative and we therefore use 17.7.15 with  $n = -\frac{1}{4}$ ,  $\sin^2 \alpha = \frac{1}{4}$

$$N = (1-n)^{-1}(\sin^2 \alpha - n) = .4, \quad p_2 = \sqrt{.1}$$

and therefore

$$\begin{aligned}(5/2)^{\frac{1}{2}} \Pi\left(-\frac{1}{4}; 45^\circ \setminus 30^\circ\right) &= (9/40)^{\frac{1}{2}} \Pi\left(\frac{3}{8}; 45^\circ \setminus 30^\circ\right) \\ &\quad + \frac{1}{2}(5/2)^{\frac{1}{2}} F(45^\circ \setminus 30^\circ) + \arctan(35)^{-\frac{1}{2}}\end{aligned}$$

Using Tables 4.14, 17.5, and 17.9 we get

$$\Pi\left(-\frac{1}{4}; 45^\circ \setminus 30^\circ\right) = .76987$$

## References

- Texts**
- [17.1] A. Cayley, An elementary treatise on elliptic functions (Dover Publications, Inc., New York, N.Y., 1956).
  - [17.2] A. Erdélyi et al., Higher transcendental functions, vol. 2, ch. 23 (McGraw-Hill Book Co., Inc., New York, N.Y., 1953).
  - [17.3] L. V. King, On the direct numerical calculation of elliptic functions and integrals (Cambridge Univ. Press, Cambridge, England, 1924).
  - [17.4] E. H. Neville, Jacobian elliptic functions, 2d ed. (Oxford Univ. Press, London, England, 1951).
  - [17.5] F. Oberhettinger and W. Magnus, Anwendung der elliptischen Funktionen in Physik und Technik (Springer-Verlag, Berlin, Germany, 1949).
  - [17.6] F. Tricomi, Elliptische Funktionen (Akademische Verlagsgesellschaft, Leipzig, Germany, 1948).
  - [17.7] E. T. Whittaker and G. N. Watson, A course of modern analysis, chs. 20, 21, 22, 4th ed. (Cambridge Univ. Press, Cambridge, England, 1952).
- Tables**
- [17.8] P. F. Byrd and M. D. Friedman, Handbook of elliptic integrals for engineers and physicists (Springer-Verlag, Berlin, Germany, 1954).
  - [17.9] C. Heuman, Tables of complete elliptic integrals, J. Math. Phys. 20, 127-206 (1941).
  - [17.10] J. Houël, Recueil de formules et de tables numériques (Gauthier-Villars, Paris, France, 1901).

- [17.11] E. Jahnke and F. Emde, *Tables of functions*, 4th ed. (Dover Publications, Inc., New York, N.Y., 1945).
- [17.12] L. M. Milne-Thomson, *Jacobian elliptic function tables* (Dover Publications, Inc., New York, N.Y., 1956).
- [17.13] L. M. Milne-Thomson, Ten-figure table of the complete elliptic integrals  $K$ ,  $K'$ ,  $E$ ,  $E'$  and a table of  $\frac{1}{\vartheta_2^2(0|\tau)}$ ,  $\frac{1}{\vartheta_3^{2n}(0|\tau)}$ , *Proc. London Math. Soc.* **2**, 33 (1931).
- [17.14] L. M. Milne-Thomson, The Zeta function of Jacobi, *Proc. Roy. Soc. Edinburgh* **52** (1931).
- [17.15] L. M. Milne-Thomson, *Die elliptischen Funktionen von Jacobi* (Julius Springer, Berlin, Germany, 1931).
- [17.16] K. Pearson, *Tables of the complete and incomplete elliptic integrals* (Cambridge Univ. Press, Cambridge, England, 1934).
- [17.17] G. W. and R. M. Spenceley, *Smithsonian elliptic function tables*, *Smithsonian Miscellaneous Collection*, vol. 109 (Washington, D.C., 1947).

# 18. Weierstrass Elliptic and Related Functions

THOMAS H. SOUTHARD<sup>1</sup>

## Contents

|   | Page |
|---|------|
| <b>Mathematical Properties</b> . . . . .  | 629  |
| 18.1. Definitions, Symbolism, Restrictions and Conventions . .  | 629  |
| 18.2. Homogeneity Relations, Reduction Formulas and Processes .   | 631  |
| 18.3. Special Values and Relations . . . . .  | 633  |
| 18.4. Addition and Multiplication Formulas . . . . .  | 635  |
| 18.5. Series Expansions. . . . .  | 635  |
| 18.6. Derivatives and Differential Equations . . . . .  | 640  |
| 18.7. Integrals . . . . .   | 641  |
| 18.8. Conformal Mapping . . . . .   | 642  |
| 18.9. Relations with Complete Elliptic Integrals $K$ and $K'$ and<br>Their Parameter $m$ and with Jacobi's Elliptic Functions . | 649  |
| 18.10. Relations with Theta Functions . . . . .   | 650  |
| 18.11. Expressing any Elliptic Function in Terms of $\wp$ and $\wp'$ . .  | 651  |
| 18.12. Case $\Delta=0$ . . . . .  | 651  |
| 18.13. Equianharmonic Case ( $g_2=0, g_3=1$ ). . . . .  | 652  |
| 18.14. Lemniscatic Case ( $g_2=1, g_3=0$ ). . . . .   | 658  |
| 18.15. Pseudo-Lemniscatic Case ( $g_2=-1, g_3=0$ ). . . . .   | 662  |
| <b>Numerical Methods</b> . . . . .  | 663  |
| 18.16. Use and Extension of the Tables . . . . .  | 663  |
| <b>References</b> . . . . .   | 670  |

---

<sup>1</sup> University of California, National Bureau of Standards, and California State College at Hayward.

## 18. Weierstrass Elliptic and Related Functions

### Mathematical Properties

#### 18.1. Definitions, Symbolism, Restrictions and Conventions

An elliptic function is a single-valued doubly periodic function of a single complex variable which is analytic except at poles and whose only singularities in the finite plane are poles. If  $\omega$  and  $\omega'$  are a pair of (primitive) half-periods of such a function  $f(z)$ , then  $f(z+2M\omega+2N\omega')=f(z)$ ,  $M$  and  $N$  being integers. Thus the study of any such function can be reduced to consideration of its behavior in a *fundamental period parallelogram* (FPP). An elliptic function has a finite number of poles (and the same number of zeros) in a FPP; the number of such poles (zeros) (an irreducible set) is the *order* of the function (poles and zeros are counted according to their multiplicity). All other poles (zeros) are called *congruent* to the irreducible set. The simplest (non-trivial) elliptic functions are of order two. One may choose as the standard function of order two either a function with two simple poles (Jacobi's choice) or one double pole (Weierstrass' choice) in a FPP.

*Weierstrass'  $\mathcal{P}$ -Function.* Let  $\omega, \omega'$  denote a pair of complex numbers with  $\mathcal{I}(\omega'/\omega) > 0$ . Then  $\mathcal{P}(z) = \mathcal{P}(z|\omega, \omega')$  is an elliptic function of order two with periods  $2\omega, 2\omega'$  and having a double pole at  $z=0$ , whose principal part is  $z^{-2}$ ;  $\mathcal{P}(z) - z^{-2}$  is analytic in a neighborhood of the origin and vanishes at  $z=0$ .

*Weierstrass'  $\zeta$ -Function*  $\zeta(z) = \zeta(z|\omega, \omega')$  satisfies the condition  $\zeta'(z) = -\mathcal{P}(z)$ ; further,  $\zeta(z)$  has a simple pole at  $z=0$  whose principal part is  $z^{-1}$ ;  $\zeta(z) - z^{-1}$  vanishes at  $z=0$  and is analytic in a neighborhood of the origin.  $\zeta(z)$  is *NOT* an elliptic function, since it is not periodic. However, it is quasi-periodic (see "period" relations), so reduction to FPP is possible.

*Weierstrass'  $\sigma$ -Function*  $\sigma(z) = \sigma(z|\omega, \omega')$  satisfies the condition  $\sigma'(z)/\sigma(z) = \zeta(z)$ ; further,  $\sigma(z)$  is an entire function which vanishes at the origin. Like  $\zeta$ , it is *NOT* an elliptic function, since it is not periodic. However, it is quasi-periodic (see "period" relations), so reduction to FPP is possible.

#### Invariants $g_2$ and $g_3$

Let  $W = 2M\omega + 2N\omega'$ ,  $M$  and  $N$  being integers. Then

$$18.1.1 \quad g_2 = 60\Sigma'W^{-4} \text{ and } g_3 = 140\Sigma'W^{-6}$$

are the INVARIANTS, summation being over all pairs  $M, N$  except  $M=N=0$ .

#### Alternate Symbolism Emphasizing Invariants

$$18.1.2 \quad \mathcal{P}(z) = \mathcal{P}(z; g_2, g_3)$$

$$18.1.3 \quad \mathcal{P}'(z) = \mathcal{P}'(z; g_2, g_3)$$

$$18.1.4 \quad \zeta(z) = \zeta(z; g_2, g_3)$$

$$18.1.5 \quad \sigma(z) = \sigma(z; g_2, g_3)$$

#### Fundamental Differential Equation, Discriminant and Related Quantities

$$18.1.6 \quad \mathcal{P}'^2(z) = 4\mathcal{P}^3(z) - g_2\mathcal{P}(z) - g_3$$

$$18.1.7$$

$$= 4(\mathcal{P}(z) - e_1)(\mathcal{P}(z) - e_2)(\mathcal{P}(z) - e_3)$$

$$18.1.8$$

$$\Delta = g_2^3 - 27g_3^2 = 16(e_2 - e_3)^2(e_3 - e_1)^2(e_1 - e_2)^2$$

$$18.1.9$$

$$g_2 = -4(e_1e_2 + e_1e_3 + e_2e_3) = 2(e_1^2 + e_2^2 + e_3^2)$$

$$18.1.10 \quad g_3 = 4e_1e_2e_3 = \frac{4}{3}(e_1^3 + e_2^3 + e_3^3)$$

$$18.1.11 \quad e_1 + e_2 + e_3 = 0$$

$$18.1.12 \quad e_1^4 + e_2^4 + e_3^4 = g_2^2/8$$

$$18.1.13 \quad 4e_i^3 - g_2e_i - g_3 = 0 (i=1, 2, 3)$$

#### Agreement about Values of Invariants (and Discriminant)

We shall consider, in this chapter, only *real*  $g_2$  and  $g_3$  (this seems to cover most applications)—hence  $\Delta$  is real. We shall dichotomize most of what follows (either  $\Delta > 0$  or  $\Delta < 0$ ). Homogeneity relations 18.2.1–18.2.15 enable a further restriction to non-negative  $g_3$  (except for one case when  $\Delta = 0$ ).

#### Note on Symbolism for Roots of Complex Numbers and for Conjugate Complex Numbers

In this chapter,  $z^{1/n}$  ( $n$  a positive integer) is used to denote the principal  $n$ th root of  $z$ , as in chapter 3;  $\bar{z}$  is used to denote the complex conjugate of  $z$ .

FPP's, Symbols for Periods, etc.

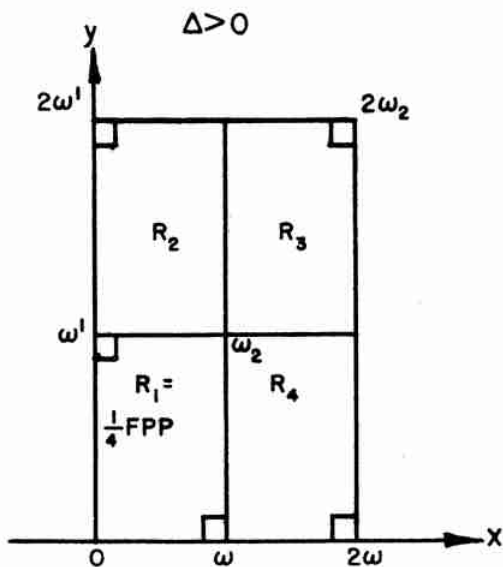

RECTANGLE

$\omega$  REAL  
 $\omega'$  PURE IMAG.  
 $|\omega'| \geq \omega$ , since  $g_3 \geq 0$

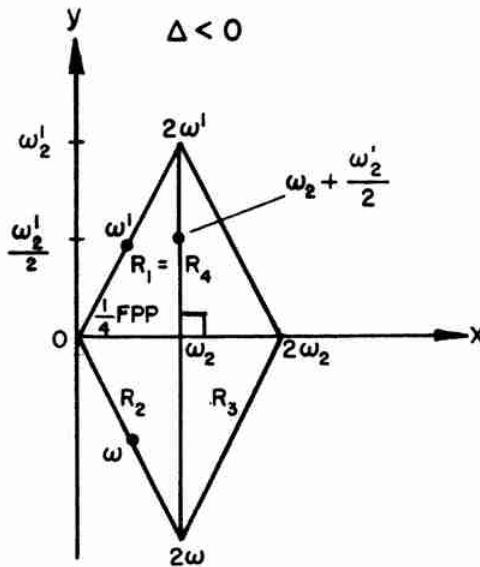

RHOMBUS

$\omega_2$  REAL  
 $\omega'_2$  PURE IMAG.  
 $|\omega'_2| \geq \omega_2$ , since  $g_3 \geq 0$

FIGURE 18.1

$$\begin{aligned} \omega_1 &= \omega \\ \omega_2 &= \omega + \omega' & \omega'_2 &= \omega' - \omega \\ \omega_3 &= \omega' \end{aligned}$$

Fundamental Rectangles

Study of all four functions ( $\mathcal{P}, \mathcal{P}', \zeta, \sigma$ ) can be reduced to consideration of their values in a Fundamental Rectangle including the origin (see 18.2 on homogeneity relations, reduction formulas and processes).

$\Delta > 0$

$\Delta < 0$

Fundamental Rectangle is  $\frac{1}{4}$  FPP, which has vertices  $0, \omega, \omega_2$  and  $\omega'$

Fundamental Rectangle has vertices  $0, \omega_2, \omega_2 + \frac{\omega'_2}{2}, \frac{\omega'_2}{2}$

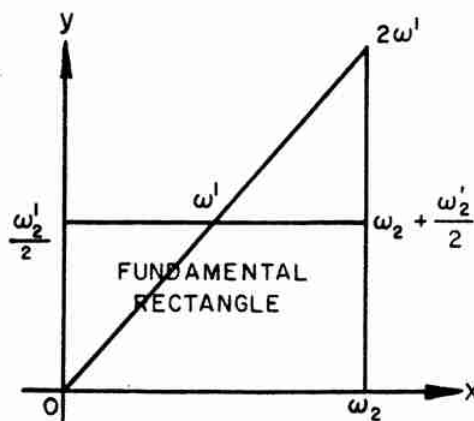
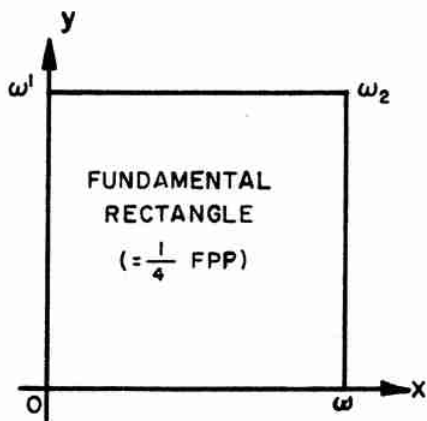

FIGURE 18.2

There is a point on the right boundary of Fundamental Rectangle where  $\mathcal{P} = 0$ . Denote it by  $z_0$ .



**18.2. Homogeneity Relations, Reduction Formulas and Processes**

**Homogeneity Relations (Suppose  $t \neq 0$ )**

Note that Period Ratio is preserved.

- 18.2.1  $\mathcal{P}'(tz|t\omega, t\omega') = t^{-3} \mathcal{P}'(z|\omega, \omega')$
- 18.2.2  $\mathcal{P}(tz|t\omega, t\omega') = t^{-2} \mathcal{P}(z|\omega, \omega')$
- 18.2.3  $\zeta(tz|t\omega, t\omega') = t^{-1} \zeta(z|\omega, \omega')$
- 18.2.4  $\sigma(tz|t\omega, t\omega') = t\sigma(z|\omega, \omega')$
- 18.2.5  $g_2(t\omega, t\omega') = t^{-4} g_2(\omega, \omega')$
- 18.2.6  $g_3(t\omega, t\omega') = t^{-6} g_3(\omega, \omega')$
- 18.2.7  $e_i(t\omega, t\omega') = t^{-2} e_i(\omega, \omega'), i=1, 2, 3$
- 18.2.8  $\Delta(t\omega, t\omega') = t^{-12} \Delta(\omega, \omega')$
- 18.2.9  $H_i(t\omega, t\omega') = t^{-2} H_i(\omega, \omega'), i=1, 2, 3$   
(See 18.3)
- 18.2.10  $q(t\omega, t\omega') = q(\omega, \omega')$  (See 18.10)
- 18.2.11  $m(t\omega, t\omega') = m(\omega, \omega')$  (See 18.9)
- 18.2.12  $\mathcal{P}'(tz; t^{-4}g_2, t^{-6}g_3) = t^{-3} \mathcal{P}'(z; g_2, g_3)$
- 18.2.13  $\mathcal{P}(tz; t^{-4}g_2, t^{-6}g_3) = t^{-2} \mathcal{P}(z; g_2, g_3)$
- 18.2.14  $\zeta(tz; t^{-4}g_2, t^{-6}g_3) = t^{-1} \zeta(z; g_2, g_3)$
- 18.2.15  $\sigma(tz; t^{-4}g_2, t^{-6}g_3) = t\sigma(z; g_2, g_3)$

**The Case  $g_3 < 0$**

Put  $t=i$  and obtain, e.g.,

18.2.16  $\mathcal{P}(z; g_2, g_3) = -\mathcal{P}(iz; g_2, -g_3)$

Thus the case  $g_3 < 0$  can be reduced to one where  $g_3 > 0$ .

**“Period” Relations and Reduction to the FPP ( $M, N$  integers)**

18.2.17  $\mathcal{P}'(z+2M\omega+2N\omega') = \mathcal{P}'(z)$

18.2.18  $\mathcal{P}(z+2M\omega+2N\omega') = \mathcal{P}(z)$

18.2.19

$$\zeta(z+2M\omega+2N\omega') = \zeta(z) + 2M\eta + 2N\eta'$$

18.2.20

$$\begin{aligned} \sigma(z+2M\omega+2N\omega') \\ = (-1)^{M+N+MN} \sigma(z) \exp [(z+M\omega+N\omega')(2M\eta \\ + 2N\eta')] \end{aligned}$$

18.2.21 where  $\eta = \zeta(\omega), \eta' = \zeta(\omega')$

**“Conjugate” Values**

$f(\bar{z}) = \bar{f}(z)$ , where  $f$  is any one of the functions  $\mathcal{P}, \mathcal{P}', \zeta, \sigma$ .

**Reduction to  $\frac{1}{4}$  FPP (See Figure 18.1)**

$\Delta > 0$

$\Delta < 0$

( $\bar{s}$  denotes conjugate of  $s$ )

**Point  $z_4$  in  $R_4$**

- 18.2.22  $\mathcal{P}'(z_4) = -\overline{\mathcal{P}'(2\omega - z_4)}$
- 18.2.23  $\mathcal{P}(z_4) = \overline{\mathcal{P}(2\omega - z_4)}$
- 18.2.24  $\zeta(z_4) = -\overline{\zeta(2\omega - z_4)} + 2\eta$
- 18.2.25  $\sigma(z_4) = \overline{\sigma(2\omega - z_4)} \exp [2\eta(z_4 - \omega)]$

- $\mathcal{P}'(\bar{z}_4) = -\overline{\mathcal{P}'(2\omega_2 - z_4)}$
- $\mathcal{P}(z_4) = \overline{\mathcal{P}(2\omega_2 - z_4)}$
- $\zeta(z_4) = -\overline{\zeta(2\omega_2 - z_4)} + 2(\eta + \eta')$
- $\sigma(z_4) = \overline{\sigma(2\omega_2 - z_4)} \exp [2(\eta + \eta')(z_4 - \omega_2)]$

**Point  $z_3$  in  $R_3$**

- 18.2.26  $\mathcal{P}'(z_3) = -\mathcal{P}'(2\omega_2 - z_3)$
- 18.2.27  $\mathcal{P}(z_3) = \mathcal{P}(2\omega_2 - z_3)$
- 18.2.28  $\zeta(z_3) = -\zeta(2\omega_2 - z_3) + 2(\eta + \eta')$
- 18.2.29  $\sigma(z_3) = \sigma(2\omega_2 - z_3) \exp [2(\eta + \eta')(z_3 - \omega_2)]$

- $\mathcal{P}'(z_3) = -\mathcal{P}'(2\omega_2 - z_3)$
- $\mathcal{P}(z_3) = \mathcal{P}(2\omega_2 - z_3)$
- $\zeta(z_3) = -\zeta(2\omega_2 - z_3) + 2(\eta + \eta')$
- $\sigma(z_3) = \sigma(2\omega_2 - z_3) \exp [2(\eta + \eta')(z_3 - \omega_2)]$

**Point  $z_2$  in  $R_2$**

- 18.2.30  $\mathcal{P}'(z_2) = \overline{\mathcal{P}'(z_2 - 2\omega')}$
- 18.2.31  $\mathcal{P}(z_2) = \overline{\mathcal{P}(z_2 - 2\omega')}$
- 18.2.32  $\zeta(z_2) = \overline{\zeta(z_2 - 2\omega')} + 2\eta'$
- 18.2.33  $\sigma(z_2) = -\overline{\sigma(z_2 - 2\omega')} \exp [2\eta'(z_2 - \omega')]$

- $\mathcal{P}'(z_2) = \overline{\mathcal{P}'(\bar{z}_2)}$
- $\mathcal{P}(z_2) = \overline{\mathcal{P}(\bar{z}_2)}$
- $\zeta(z_2) = \overline{\zeta(\bar{z}_2)}$
- $\sigma(z_2) = \overline{\sigma(\bar{z}_2)}$

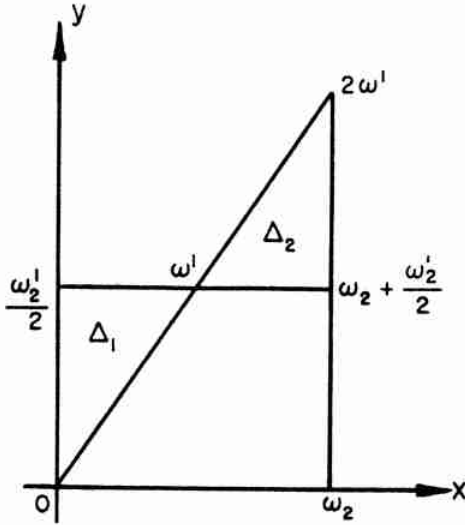

FIGURE 18.3

**Reduction from  $\frac{1}{4}$  FPP to Fundamental Rectangle in Case  $\Delta < 0$**

We need only be concerned with the case when  $z$  is in triangle  $\Delta_2$  (therefore  $2\omega' - z$  is in triangle  $\Delta_1$ ).

**18.2.34**  $\mathcal{P}(z) = \mathcal{P}(2\omega' - z)$

**18.2.35**  $\mathcal{P}'(z) = -\mathcal{P}'(2\omega' - z)$

**18.2.36**  $\zeta(z) = 2\eta' - \zeta(2\omega' - z)$

**18.2.37**  $\sigma(z) = \sigma(2\omega' - z) \exp [2\eta'(z - \omega')]$

**Reduction to Case where Real Half-Period is Unity**

(preserving period ratio)

$\Delta > 0$

$\Delta < 0$

$(\omega_2 = \omega + \omega')$

**18.2.38**  $\mathcal{P}'(z|\omega, \omega') = \omega^{-3} \mathcal{P}'\left(z\omega^{-1} | 1, \frac{\omega'}{\omega}\right)$        $\mathcal{P}'(z|\omega, \omega') = \omega_2^{-3} \mathcal{P}'\left(z\omega_2^{-1} \left| \frac{\omega}{\omega_2}, \frac{\omega'}{\omega_2} \right.\right)$

**18.2.39**  $\mathcal{P}(z|\omega, \omega') = \omega^{-2} \mathcal{P}\left(z\omega^{-1} | 1, \frac{\omega'}{\omega}\right)$        $\mathcal{P}(z|\omega, \omega') = \omega_2^{-2} \mathcal{P}\left(z\omega_2^{-1} \left| \frac{\omega}{\omega_2}, \frac{\omega'}{\omega_2} \right.\right)$

**18.2.40**  $\zeta(z|\omega, \omega') = \omega^{-1} \zeta\left(z\omega^{-1} | 1, \frac{\omega'}{\omega}\right)$        $\zeta(z|\omega, \omega') = \omega_2^{-1} \zeta\left(z\omega_2^{-1} \left| \frac{\omega}{\omega_2}, \frac{\omega'}{\omega_2} \right.\right)$

**18.2.41**  $\sigma(z|\omega, \omega') = \omega \sigma\left(z\omega^{-1} | 1, \frac{\omega'}{\omega}\right)$        $\sigma(z|\omega, \omega') = \omega_2 \sigma\left(z\omega_2^{-1} \left| \frac{\omega}{\omega_2}, \frac{\omega'}{\omega_2} \right.\right)$

**18.2.42**  $g_2(\omega, \omega') = \omega^{-4} g_2\left(1, \frac{\omega'}{\omega}\right)$        $g_2(\omega, \omega') = \omega_2^{-4} g_2\left(\frac{\omega}{\omega_2}, \frac{\omega'}{\omega_2}\right)$

**18.2.43**  $g_3(\omega, \omega') = \omega^{-6} g_3\left(1, \frac{\omega'}{\omega}\right)$        $g_3(\omega, \omega') = \omega_2^{-6} g_3\left(\frac{\omega}{\omega_2}, \frac{\omega'}{\omega_2}\right)$

**18.2.44**  $e_i(\omega, \omega') = \omega^{-2} e_i\left(1, \frac{\omega'}{\omega}\right)$        $e_i(\omega, \omega') = \omega_2^{-2} e_i\left(\frac{\omega}{\omega_2}, \frac{\omega'}{\omega_2}\right)$

$(i=1, 2, 3)$

$(i=1, 2, 3)$

**18.2.45**  $\Delta(\omega, \omega') = \omega^{-12} \Delta\left(1, \frac{\omega'}{\omega}\right)$        $\Delta(\omega, \omega') = \omega_2^{-12} \Delta\left(\frac{\omega}{\omega_2}, \frac{\omega'}{\omega_2}\right)$

NOTE: New real half-period is

$$\frac{\omega}{\omega_2} + \frac{\omega'}{\omega_2} = \frac{\omega + \omega'}{\omega_2} = 1$$

## 18.3. Special Values and Relations

## Values at Periods

$\mathcal{P}$ ,  $\mathcal{P}'$ , and  $\zeta$  are infinite,  $\sigma$  is zero at  $z=2\omega_i$ ,  $i=1, 2, 3$  and at  $2\omega'_i$  ( $\Delta < 0$ ).

$$\Delta > 0$$

$$\Delta < 0$$

## Half-Periods

- 18.3.1  $\mathcal{P}(\omega_i) = e_i$  ( $i=1, 2, 3$ )
- 18.3.2  $\mathcal{P}'(\omega_i) = 0$  ( $i=1, 2, 3$ )
- 18.3.3  $\eta_i = \zeta(\omega_i)$  ( $i=1, 2, 3$ )
- 18.3.4  $\eta_1 = \eta$ ,  $\eta_2 = \eta + \eta'$ ,  $\eta_3 = \eta'$
- 18.3.5  $H_i^2 = 2e_i^2 + e_j e_k$  ( $i, j, k=1, 2, 3$ ;  $i \neq j$ ,  $i \neq k$ ,  $j \neq k$ )
- 18.3.6  $= (e_i - e_j)(e_i - e_k) = 2e_i^2 + \frac{g_3}{4e_i} = 3e_i^2 - \frac{g_2}{4}$
- 18.3.7  $e_i$  real  $e_2$  real and non-negative
- 18.3.8  $e_1 > 0 \geq e_2 > e_3$   $(e_2 = 0$  when  $g_3 = 0)$   
 (equality when  $g_3 = 0$ )  $e_1 = -\alpha + i\beta$ ,  $e_3 = \bar{e}_1$   
where  $\alpha \geq 0$ ,  $\beta > 0$   
(equality when  $g_3 = 0$ )
- 18.3.9  $\eta > 0$   $\eta'_2 = \zeta(\omega'_2) = \eta' - \eta$
- 18.3.10  $\eta'/i \leq 0$  if  $\eta_2 > 0$
- 18.3.11  $|\omega'|/\omega \leq 1.91014\ 050$  (approx.)  $\eta'_2/i \leq 0$  if  $|\omega'_2|/\omega_2 \leq 3.81915\ 447$  (approx.)
- 18.3.12  $H_1 > 0$ ,  $H_3 > 0$   $H_2 > 0$
- 18.3.13  $H_2 = i\sqrt{-H_3^2}$   $\pi/4 < \arg(H_3) \leq \pi/2$  (equality if  $g_3 = 0$ );  $H_1 = \bar{H}_3$
- 18.3.14  $\sigma(\omega) = e^{\eta\omega/2}/H_1^{1/2}$   $\sigma(\omega_2) = e^{\eta_2\omega_2/2}/H_2^{1/2}$
- 18.3.15  $\sigma(\omega') = ie^{\eta'\omega'/2}/H_3^{1/2}$   $\sigma(\omega'_2) = ie^{\eta'_2\omega'_2/2}/H_3^{1/2}$
- 18.3.16  $\sigma^2(\omega_2) = e^{\eta_2\omega_2}/(-H_2)$   $\sigma^2(\omega') = e^{\eta'\omega'}/(-H_3)$
- 18.3.17  $\arg[\sigma(\omega_2)] = \frac{\eta'_2\omega_2}{4i} + \frac{\pi}{2}$   $\arg[\sigma(\omega')] = \frac{\eta'_2\omega_2}{4i} + \frac{\pi}{2} - \frac{1}{2} \arg(e_2 + H_2 - e_i)$
- 18.3.18  $\mathcal{P}(\omega/2) = e_1 + H_1 > e_1$   $\mathcal{P}(\omega_2/2) = e_2 + H_2 > e_2$
- 18.3.19  $\mathcal{P}'(\omega/2) = -2H_1\sqrt{2H_1+3e_1}$   $\mathcal{P}'(\omega_2/2) = -2H_2\sqrt{2H_2+3e_2}$
- 18.3.20  $\zeta(\omega/2) = \frac{1}{2}[\eta + \sqrt{2H_1+3e_1}]$   $\zeta(\omega_2/2) = \frac{1}{2}[\eta_2 + \sqrt{2H_2+3e_2}]$

## Quarter Periods

$\Delta > 0$  $\Delta < 0$ 

$$18.3.21 \quad \sigma(\omega/2) = \frac{e^{\eta\omega/8}}{2^{1/4}H_1^{3/8}(2H_1+3e_1)^{1/8}}$$

$$\sigma(\omega_2/2) = \frac{e^{\eta_2\omega_2/8}}{2^{1/4}H_2^{3/8}(2H_2+3e_2)^{1/8}}$$

$$18.3.22 \quad \mathcal{P}(\omega'/2) = e_3 - H_3 < e_3 < 0$$

$$\mathcal{P}(\omega'_2/2) = e_2 - H_2 = \mathcal{P}(\omega_2 + \omega'_2/2) < e_2 < 0$$

$$18.3.23 \quad \mathcal{P}'(\omega'/2) = -2H_3i\sqrt{2H_3-3e_3}$$

$$\mathcal{P}'(\omega'_2/2) = -2H_2i\sqrt{2H_2-3e_2} = \overline{\mathcal{P}'}(\omega_2 + \omega'_2/2)$$

$$18.3.24 \quad \zeta(\omega'/2) = \frac{1}{2}[\eta' - i\sqrt{2H_3-3e_3}]$$

$$\zeta(\omega'_2/2) = \frac{1}{2}[\eta'_2 - i\sqrt{2H_2-3e_2}] = -\zeta(\omega_2 + \omega'_2/2) + 2\eta'$$

$$18.3.25 \quad \sigma(\omega'/2) = \frac{ie^{\eta'\omega'/8}}{2^{1/4}H_3^{3/8}(2H_3-3e_3)^{1/8}}$$

$$\sigma(\omega'_2/2) = \frac{ie^{\eta'_2\omega'_2/8}}{2^{1/4}H_2^{3/8}(2H_2-3e_2)^{1/8}}$$

$$= \sigma(\omega_2 + \omega'_2/2) \exp[-\eta'\omega_2]$$

$$18.3.26 \quad \mathcal{P}(\omega_2/2) = e_2 - H_2$$

$$\mathcal{P}(\omega'/2) = e_3 - H_3$$

$$18.3.27 \quad \mathcal{P}'(\omega_2/2) = -2H_2i(2H_2-3e_2)^{\frac{1}{2}}$$

$$\mathcal{P}'(\omega'/2) = -2iH_3(2H_3-3e_3)^{\frac{1}{2}}$$

$$18.3.28 \quad \zeta(\omega_2/2) = \frac{1}{2}[\eta_2 - i(2H_2-3e_2)^{\frac{1}{2}}]$$

$$\zeta(\omega'/2) = \frac{1}{2}[\eta' - i(2H_3-3e_3)^{\frac{1}{2}}]$$

$$18.3.29 \quad \sigma(\omega_2/2) = \frac{e^{\eta_2\omega_2/8}e^{i\pi/4}}{[4H_2^3(2H_2-3e_2)]^{1/8}}$$

$$\sigma(\omega'/2) = \frac{e^{\eta'\omega'/8}e^{i\pi/4}}{[4H_3^3(2H_3-3e_3)]^{1/8}}$$

#### One-Third Period Relations

At  $z=2\omega_i/3$  ( $i=1, 2, 3$ ) or  $2\omega'_i/3$ ,  $\mathcal{P}''^2 = 12\mathcal{P}\mathcal{P}'^2$ ;

equivalently:

$$18.3.30 \quad 48\mathcal{P}^4 - 24g_2\mathcal{P}^2 - 48g_3\mathcal{P} - g_2^2 = 0$$

 $\Delta > 0$  $\Delta < 0$ 

$$18.3.31 \quad \zeta(2\omega/3) = \frac{2\eta}{3} + \left[ \frac{\mathcal{P}(2\omega/3)}{3} \right]^{\frac{1}{2}}$$

$$\zeta(2\omega_2/3) = \frac{2\eta_2}{3} + \left[ \frac{\mathcal{P}(2\omega_2/3)}{3} \right]^{\frac{1}{2}}$$

$$18.3.32 \quad \zeta(2\omega'/3) = \frac{2\eta'}{3} - \left[ \frac{\mathcal{P}(2\omega'/3)}{3} \right]^{\frac{1}{2}}$$

$$\zeta(2\omega'_2/3) = \frac{2\eta'_2}{3} - \left[ \frac{\mathcal{P}(2\omega'_2/3)}{3} \right]^{\frac{1}{2}}$$

$$18.3.33 \quad \zeta(2\omega_2/3) = \frac{2\eta_2}{3} + \left[ \frac{\mathcal{P}(2\omega_2/3)}{3} \right]^{\frac{1}{2}}$$

$$\zeta(2\omega'/3) = \frac{2\eta'}{3} + \left[ \frac{\mathcal{P}(2\omega'/3)}{3} \right]^{\frac{1}{2}}$$

$$18.3.34 \quad \sigma(2\omega/3) = \frac{-\exp[2\eta\omega/9]}{\sqrt[3]{\mathcal{P}'(2\omega/3)}}$$

$$\sigma(2\omega_2/3) = \frac{-\exp[2\eta_2\omega_2/9]}{\sqrt[3]{\mathcal{P}'(2\omega_2/3)}}$$

$$18.3.35 \quad \sigma(2\omega'/3) = \frac{-\exp[2\eta'\omega'/9]}{[\mathcal{P}'(2\omega'/3)]^{1/3}e^{2\pi i/3}}$$

$$\sigma(2\omega'_2/3) = \frac{-\exp[2\eta'_2\omega'_2/9]}{[\mathcal{P}'(2\omega'_2/3)]^{1/3}e^{2\pi i/3}}$$

$$18.3.36 \quad \sigma(2\omega_2/3) = \frac{-\exp[2\eta_2\omega_2/9]}{[\mathcal{P}'(2\omega_2/3)]^{1/3}e^{2\pi i/3}}$$

$$\sigma(2\omega'/3) = \frac{-\exp[2\eta'\omega'/9]}{[\mathcal{P}'(2\omega'/3)]^{1/3}e^{2\pi i/3}}$$

#### Legendre's Relation

$$18.3.37 \quad \eta\omega' - \eta'\omega = \pi i/2$$

$$\eta_2\omega'_2 - \eta'_2\omega_2 = \pi i$$

(also valid for  $\Delta < 0$ )

#### Relations Among the $H_i$

$$18.3.38 \quad H_1^2 + H_2^2 + H_3^2 = 3g_2/4$$

$$18.3.39 \quad H_1^2H_2^2 + H_2^2H_3^2 + H_3^2H_1^2 = 0$$

18.3.40

$$H_1^2 H_2^2 H_3^2 = -\Delta/16$$

18.3.41

$$16H_i^2 - 12g_2 H_i^4 + \Delta = 0 (i=1, 2, 3)$$

### 18.4. Addition and Multiplication Formulas

#### Addition Formulas<sup>2</sup> ( $z_1 \neq z_2$ )

$$18.4.1 \quad \mathcal{P}(z_1 + z_2) = \frac{1}{4} \left[ \frac{\mathcal{P}'(z_1) - \mathcal{P}'(z_2)}{\mathcal{P}(z_1) - \mathcal{P}(z_2)} \right]^2 - \mathcal{P}(z_1) - \mathcal{P}(z_2)$$

$$18.4.2 \quad \mathcal{P}'(z_1 + z_2) = \frac{\mathcal{P}(z_1 + z_2) [\mathcal{P}'(z_1) - \mathcal{P}'(z_2)] + \mathcal{P}(z_1) \mathcal{P}'(z_2) - \mathcal{P}'(z_1) \mathcal{P}(z_2)}{\mathcal{P}(z_2) - \mathcal{P}(z_1)}$$

$$18.4.3 \quad \zeta(z_1 + z_2) = \zeta(z_1) + \zeta(z_2) + \frac{1}{2} \frac{\mathcal{P}'(z_1) - \mathcal{P}'(z_2)}{\mathcal{P}(z_1) - \mathcal{P}(z_2)}$$

$$18.4.4 \quad \sigma(z_1 + z_2) \sigma(z_1 - z_2) = -\sigma^2(z_1) \sigma^2(z_2) [\mathcal{P}(z_1) - \mathcal{P}(z_2)]$$

#### Duplication and Triplication Formulas

$$\left[ \text{Note that } \mathcal{P}'' = 6\mathcal{P}^2(z) - \frac{g_2}{2}, \mathcal{P}'^2(z) = 4\mathcal{P}^3(z) - g_2\mathcal{P}(z) - g_3 \text{ and } \mathcal{P}'''(z) = 12\mathcal{P}(z)\mathcal{P}'(z) \right]$$

$$18.4.5 \quad \mathcal{P}(2z) = -2\mathcal{P}(z) + \left[ \frac{\mathcal{P}''(z)}{2\mathcal{P}'(z)} \right]^2$$

$$18.4.6 \quad \mathcal{P}'(2z) = \frac{-4\mathcal{P}'^4(z) + 12\mathcal{P}(z)\mathcal{P}'^2(z)\mathcal{P}''(z) - \mathcal{P}'''^2(z)}{4\mathcal{P}'^3(z)}$$

$$18.4.7 \quad \zeta(2z) = 2\zeta(z) + \mathcal{P}''(z)/2\mathcal{P}'(z)$$

$$18.4.8 \quad \sigma(2z) = -\mathcal{P}'(z)\sigma^4(z)$$

$$18.4.9 \quad \zeta(3z) = 3\zeta(z) + \frac{4\mathcal{P}'^3(z)}{\mathcal{P}'(z)\mathcal{P}'''(z) - \mathcal{P}''^2(z)}$$

$$18.4.10 \quad \sigma(3z) = -\mathcal{P}'^2(z)\sigma^9(z) [\mathcal{P}(2z) - \mathcal{P}(z)]$$

### 18.5. Series Expansions

#### Laurent Series

$$18.5.1 \quad \mathcal{P}(z) = z^{-2} + \sum_{k=2}^{\infty} c_k z^{2k-2}$$

18.5.2 where

$$c_2 = g_2/20, \quad c_3 = g_3/28$$

and

$$18.5.3 \quad c_k = \frac{3}{(2k+1)(k-3)} \sum_{m=2}^{k-2} c_m c_{k-m}, \quad k \geq 4$$

$$18.5.4 \quad \mathcal{P}'(z) = -2z^{-3} + \sum_{k=2}^{\infty} (2k-2)c_k z^{2k-3}$$

$$18.5.5 \quad \zeta(z) = z^{-1} - \sum_{k=2}^{\infty} c_k z^{2k-1} / (2k-1)$$

$$18.5.6 \quad \sigma(z) = \sum_{m,n=0}^{\infty} a_{m,n} (\frac{1}{2}g_2)^m (2g_3)^n \cdot \frac{z^{4m+6n+1}}{(4m+6n+1)!}$$

<sup>2</sup> Formulas for  $\zeta$  and  $\sigma$  are not true algebraic addition formulas.

18.5.7

where  $a_{0,0}=1$  and

$$18.5.8 \quad a_{m,n} = 3(m+1)a_{m+1,n-1} + \frac{16}{3}(n+1)a_{m-2,n+1} - \frac{1}{3}(2m+3n-1)(4m+6n-1)a_{m-1,n},$$

it being understood that  $a_{m,n}=0$  if either subscript is negative.

(The radius of convergence of the above series for  $\mathcal{P}-z^{-2}$ ,  $\mathcal{P}'+2z^{-3}$  and  $\zeta-z^{-1}$  is equal to the smallest of  $|2\omega|$ ,  $|2\omega'|$  and  $|2\omega \pm 2\omega'|$ ; series for  $\sigma$  converges for all  $z$ .)

Values of Coefficients<sup>3</sup>  $c_k$  in Terms of  $c_2$  and  $c_3$

18.5.9

$$c_4 = c_2^2/3$$

18.5.10

$$c_5 = 3c_2c_3/11$$

18.5.11

$$c_6 = [2c_2^3 + 3c_3^2]/39$$

18.5.12

$$c_7 = 2c_2^2c_3/33$$

18.5.13

$$c_8 = 5c_2(11c_2^3 + 36c_3^2)/7293$$

18.5.14

$$c_9 = c_3(29c_2^3 + 11c_3^2)/2717$$

18.5.15

$$c_{10} = (242c_2^5 + 1455c_2^2c_3^2)/240669$$

18.5.16

$$c_{11} = 14c_2c_3(389c_2^3 + 369c_3^2)/3187041$$

18.5.17

$$c_{12} = (114950c_2^6 + 1080000c_2^3c_3^2 + 166617c_3^4)/891678645$$

18.5.18

$$c_{13} = 10c_2^2c_3(297c_2^3 + 530c_3^2)/11685817$$

18.5.19

$$c_{14} = \frac{2c_2(528770c_2^6 + 7164675c_2^3c_3^2 + 2989602c_3^4)}{(306735)(215441)}$$

18.5.20

$$c_{15} = \frac{4c_3(62921815c_2^6 + 179865450c_2^3c_3^2 + 14051367c_3^4)}{(179685)(38920531)}$$

18.5.21

$$c_{16} = \frac{c_2^2(58957855c_2^6 + 1086511320c_2^3c_3^2 + 875341836c_3^4)}{(5909761)(5132565)}$$

18.5.22

$$c_{17} = \frac{c_2c_3(30171955c_2^6 + 126138075c_2^3c_3^2 + 28151739c_3^4)}{(920205)(6678671)}$$

$$18.5.23 \quad c_{18} = \frac{1541470 \cdot 949003c_2^6 + 30458088737 \cdot 1155c_2^3c_3^2 + 122378650673 \cdot 378c_2^2c_3^4 + 2348703 \cdot 887777c_3^6}{(1342211013)(4695105713)}$$

18.5.24

$$c_{19} = \frac{2c_2^2c_3(3365544215c_2^6 + 429852433 \cdot 45c_2^3c_3^2 + 8527743477c_3^4)}{(91100295)(113537407)}$$

<sup>3</sup> NOTES:

1.  $c_4$ - $c_{18}$  were computed and checked independently by D. H. Lehmer; these were double-checked by substituting  $g_2=20$ ,  $c_2$ ,  $g_3=28$ ,  $c_3$  in values given in [18.10].

2.  $c_{17}$ - $c_{18}$  were derived from values in [18.10] by the same substitution. These were checked (numerically) for particular values of  $g_2$ ,  $g_3$ .

3.  $c_{19}$  is given incorrectly in [18.12] (factor 13 is missing in denominator of third term of bracket); this value was computed independently.

4. No factors of any of the above integers with more than ten digits are known to the author. This is not necessarily true of smaller integers, which have, in many instances, been arranged for convenient use with a desk calculator.

Value<sup>4</sup> of Coefficients  $a_{m,n}$

|   |  |   |   |   |   |  |   |  |  |  |                |                         |           |  |
|---|--|---|---|---|---|--|---|--|--|--|----------------|-------------------------|-----------|--|
| 8 | 7 <sup>18</sup><br>-2-3-5-59<br>-107895773 |   |   |   |   |  |   |  |  |  |                |                         |           |  |
| 7 | 7 <sup>10</sup><br>-2-3-5-23<br>-257-18049 | 7 <sup>11</sup><br>-2-3-5-59<br>-107895773    |   |   |   |  |   |  |  |  |                |                         |           |  |
| 6 | 6 <sup>9</sup><br>-2-3-5<br>-229-2683      | 7 <sup>9</sup><br>-2-3-5-23<br>-257<br>-18049 | 6 <sup>11</sup><br>-2-3-5-7<br>-181-1699<br>-2803 | 8 <sup>10</sup><br>-2-3-5-7<br>-41-6047<br>-4922497 |   |  |   |  |  |  |                |                         |           |  |
| 5 | 5 <sup>8</sup><br>2-3-5<br>-9103           | 6 <sup>8</sup><br>-2-3-5-229<br>-2683         | 5 <sup>10</sup><br>-2-3-5<br>-40570423            | 4 <sup>9</sup><br>-2-3-5-7<br>-59-179<br>-142231    | 4 <sup>10</sup><br>-2-3-5-7<br>-1321<br>-1415535763 |  |   |  |  |  |                |                         |           |  |
| 4 | 5 <sup>8</sup><br>2-3-5<br>-31             | 3 <sup>7</sup><br>2-3-5-9103                  | 5 <sup>8</sup><br>-2-3-5-7<br>-13-37-41           | 4 <sup>8</sup><br>-2-3-5-691<br>-83609              | 4 <sup>8</sup><br>-2-3-5-11-31<br>-313-190387       | 4 <sup>10</sup><br>-2-3-5-7-23<br>-263-4848953 | 5 <sup>8</sup><br>-2-3-5-7-19<br>-1752686144977   |  |  |  |                |                         |           |  |
| 3 | 4 <sup>8</sup><br>2-3-23                   | 3 <sup>4</sup><br>2-3-5-31                    | 3 <sup>7</sup><br>2-3-5-17<br>-109                | 3 <sup>6</sup><br>-2-3-5-83<br>-3911                | 4 <sup>6</sup><br>-2-3-5-503<br>-156217             | 4 <sup>8</sup><br>-2-3-31<br>-315989669        | 4 <sup>7</sup><br>-2-3-5-7-11-29<br>-83-1129-9551 | 4 <sup>8</sup><br>-2-3-5-7-613<br>-17605225081 |  |  |                |                         |           |  |
| 2 | 3 <sup>3</sup><br>-2-3                     | 3 <sup>3</sup><br>2-3-23                      | 3 <sup>5</sup><br>2-3-5-53                        | 3 <sup>4</sup><br>2-3-5-37<br>-167                  | 6<br>-2-3-5-17<br>-3037                             | 4 <sup>7</sup><br>-2-3-61-151<br>-653          | 3 <sup>7</sup><br>-2-3<br>-2387260103             | 4 <sup>7</sup><br>-2-3-5-17-53<br>-2957-41189  | 9 <sup>2</sup><br>-2-3-5-7-17<br>-67-195651059 | 3 <sup>7</sup><br>2-3-5-7<br>-35866647631901 |                |                         |           |  |
| 1 | -3   | -2-3 <sup>2</sup>                             | 3 <sup>19</sup>                                   | 2-3-311   | 3-5-20807   | -2-3-11  | -3-17   | -2-3-7-13                                      | -3 <sup>7</sup>                                | -2-3-5-7-193                                 | 3 <sup>7</sup> |                         |           |  |
| 0 | 1  | -1  | -3 <sup>2</sup>                                   | 3-23  | 3-107   | 3-7-23-37                                      | 3-313-503   | -3-7   | 3-11-37  | -3-7-23-14387                                | -3-71          | -3-7-11-23 <sup>2</sup> | 3-7-24733 |  |
| 0 | 0  | 1   | 2   | 3   | 4   | 5  | 6   | 7  | 8  | 9  | 10             | 11                      | 12        |  |

<sup>4</sup> Values of  $a_{m,n}$  in unfactored form for  $4m+6n+1 \leq 35$  are given in [18,25], p. 7; of  $(a_{m,n})^2$  in factored form in [18,15], Vol. 4, p. 89 for  $4m+6n+1 \leq 25$ . Additional values were computed and checked on desk calculators; primality of large factors was established with the aid of SWAC (National Bureau of Standards Western Automatic Computer).



Reversed Series<sup>5</sup> for Large  $|\mathcal{P}|$ 

18.5.25

$$\begin{aligned}
z = \frac{1}{2} & \left[ 2u + c_2 u^5 + c_3 u^7 + \frac{\alpha_2^2}{3} u^9 + \frac{6\alpha_2 \alpha_3}{11} u^{11} \right. \\
& + \frac{1}{13} (3\alpha_2^3 + 5\alpha_3^3) u^{13} + \alpha_2^2 \alpha_3 u^{15} + \frac{5\alpha_2}{68} (12\alpha_2^3 + 7\alpha_3^3) u^{17} \\
& + \frac{5\alpha_3}{19} (\alpha_2^3 + 7\alpha_3^3) u^{19} + \frac{\alpha_2^2}{4} (3\alpha_2^3 + 10\alpha_3^3) u^{21} \\
& + \frac{35\alpha_2 \alpha_3}{92} (9\alpha_2^3 + 4\alpha_3^3) u^{23} \\
& + \frac{7}{200} (33\alpha_2^5 + 180\alpha_2^3 \alpha_3^2 + 10\alpha_3^4) u^{25} \\
& + \frac{7\alpha_2^2 \alpha_3}{12} (11\alpha_2^3 + 10\alpha_3^3) u^{27} \\
& + \frac{3\alpha_2}{2^3 \cdot 29} (143\alpha_2^5 + 1155\alpha_2^3 \alpha_3^2 + 210\alpha_3^4) u^{29} \\
& + \frac{21\alpha_3}{2^3 \cdot 31} (143\alpha_2^5 + 220\alpha_2^3 \alpha_3^2 + 6\alpha_3^4) u^{31} \\
& + \frac{3\alpha_2^2}{2^6} (65\alpha_2^5 + 728\alpha_2^3 \alpha_3^2 + 280\alpha_3^4) u^{33} \\
& + \frac{33\alpha_2 \alpha_3}{2^3 \cdot 5 \cdot 7} (195\alpha_2^5 + 455\alpha_2^3 \alpha_3^2 + 42\alpha_3^4) u^{35} \\
& + \frac{11}{2^6 \cdot 37} (1105\alpha_2^5 + 16380\alpha_2^3 \alpha_3^2 + 10920\alpha_2 \alpha_3^4) \\
& + 168\alpha_3^6) u^{37} + \frac{33\alpha_2^2 \alpha_3}{2^6} (85\alpha_2^5 + 280\alpha_2^3 \alpha_3^2 + 56\alpha_3^4) u^{39} \\
& + \frac{143\alpha_2}{2^7 \cdot 41} (323\alpha_2^5 + 6120\alpha_2^3 \alpha_3^2 + 6300\alpha_2 \alpha_3^4 + 336\alpha_3^6) u^{41} \\
& + \frac{143\alpha_3}{2^6 \cdot 43} (1615\alpha_2^5 + 7140\alpha_2^3 \alpha_3^2 + 2520\alpha_2 \alpha_3^4 + 24\alpha_3^6) u^{43} \\
& \left. + O(u^{45}) \right],
\end{aligned}$$

18.5.26 where  $\alpha_2 = g_2/8$ 18.5.27  $\alpha_3 = g_2/8$ 18.5.28  $u = (\mathcal{P}^{-1})^{\frac{1}{2}}$ Reversed Series for Large  $|\mathcal{P}'|$ 18.5.29  $z = A_1 u + A_5 u^5 + A_7 u^7 + A_9 u^9 + \dots$ 18.5.30 where  $u = (\mathcal{P}'^{1/3})^{-1} e^{i\pi/3}$ 18.5.31  $A_1 = 2^{1/3}$ 18.5.32  $A_5 = -\frac{\alpha_2}{5} A_1^2$ 18.5.33  $A_7 = \frac{-4\alpha_3 A_1}{7}$ 18.5.34  $A_9 = 0$ 18.5.35  $A_{11} = 8a_2 a_3 A_1^2 / 11$ 18.5.36  $A_{13} = \frac{10A_1}{39} (a_2^3 + 6a_3^2)$ 18.5.37  $A_{15} = -96a_2^2 a_3 / 175$ 18.5.38  $A_{17} = -\frac{14a_2 A_1^2}{51} (a_2^3 + 12a_3^2)$ 18.5.39 where  $a_2 = g_2/6$ ,  $a_3 = g_3/6$ Reversed Series for Large  $|\xi|$ 18.5.40  $z = u + A_5 u^5 + A_7 u^7 + A_9 u^9 + \dots$ 18.5.41 where  $u = \xi^{-1}$ 18.5.42  $A_5 = -\delta_2/5$ 18.5.43  $A_7 = -\delta_3/7$ 18.5.44  $A_9 = \delta_2^2/7$ 18.5.45  $A_{11} = 3\delta_2 \delta_3 / 11$ 18.5.46  $A_{13} = \frac{17}{1001} (-8\delta_2^3 + 7\delta_3^2)$ 18.5.47  $A_{15} = -41\delta_2^2 \delta_3 / 91$ 18.5.48  $A_{17} = \frac{\delta_2}{9163} (1349\delta_2^3 - 4116\delta_3^2)$ 18.5.49  $A_{19} = \frac{2\delta_3}{323323} (115431\delta_2^3 - 22568\delta_3^2)$ 18.5.50 where  $\delta_2 = g_2/12$ 18.5.51  $\delta_3 = g_3/20$ 

<sup>5</sup> In this and other series a choice of the value of the root has been made so that  $z$  will be in the Fundamental Rectangle (Figure 18.2), whenever the value of the given function is appropriate.

Other Series Involving  $\mathcal{P}$ Series near  $z_0$  [ $\mathcal{P}(z_0)=0$ ]

## 18.5.52

$$\begin{aligned} \mathcal{P} = \mathcal{P}'_0 u & \left[ 1 - 3c_2 u^4 - 4c_3 u^6 + \frac{10c_2^2}{3} u^8 + \frac{114c_2 c_3}{11} u^{10} \right. \\ & + \frac{7(12c_3^2 - 5c_2^2)}{13} u^{12} - \frac{488c_2^2 c_3}{33} u^{14} \left. \right] + u^2 \left[ -5c_2 - 14c_3 u^2 \right. \\ & + 5c_2^2 u^4 + 33c_2 c_3 u^6 + \frac{84c_3^2 - 10c_2^3}{3} u^8 - \frac{1363c_2^2 c_3 u^{10}}{33} \\ & \left. + \frac{5c_2(55c_3^2 - 2316c_2^2)u^{12}}{143} \right] + \dots \end{aligned}$$

## 18.5.53

where  $u=(z-z_0)$ ,  $\mathcal{P}'_0 \equiv \mathcal{P}'(z_0) = i\sqrt{g_3}$ 

## 18.5.54

$$\begin{aligned} u = \mathcal{P}'_0 & \left[ v + av^2 + 2a^2 v^3 + \left( \frac{g_3 \mathcal{P}'_0{}^2}{2} + 5a^3 \right) v^4 + \frac{a}{5} (3 \mathcal{P}'_0{}^4 \right. \\ & + 15g_3 \mathcal{P}'_0{}^2 + 70a^3) v^5 + 2a^2 (2 \mathcal{P}'_0{}^4 + 7g_3 \mathcal{P}'_0{}^2 + 21a^3) v^6 \\ & + \left. \left( \frac{g_3 \mathcal{P}'_0{}^6}{7} + \{g_3^2 + 20a^3\} \mathcal{P}'_0{}^4 + 15a^2 g_3 \mathcal{P}'_0{}^2 + 132a^6 \right) v^7 \right. \\ & + 15a \left( \frac{g_3 \mathcal{P}'_0{}^6}{4} + \left\{ \frac{3g_3^2}{4} + 6a^3 \right\} \mathcal{P}'_0{}^4 + \frac{33ag_3}{2} \mathcal{P}'_0{}^2 \right. \\ & + \left. \frac{143a^6}{5} \right) v^8 + \frac{5a^2}{2} \left( \frac{2}{3} \mathcal{P}'_0{}^8 + 15g_3 \mathcal{P}'_0{}^6 \right. \\ & + \left. \{154a^3 + 33g_3^2\} \mathcal{P}'_0{}^4 + \frac{2002a^3 g_3 \mathcal{P}'_0{}^2}{5} + 572a^6 \right) v^9 \\ & + \frac{1}{4} \left( 3 \{28a^3 + g_3^2\} \mathcal{P}'_0{}^8 + 11g_3 \{98a^3 + g_3^2\} \mathcal{P}'_0{}^6 \right. \\ & \left. + 2002a^3 \left\{ \frac{16}{5} a^3 + g_3^2 \right\} \mathcal{P}'_0{}^4 \right. \\ & \left. + 16016 a^6 g_3 \mathcal{P}'_0{}^2 + 19448 a^9 \right) v^{10} \left. \right] + \dots \end{aligned}$$

18.5.55 where  $v = \mathcal{P} / (\mathcal{P}'_0)^2$  and  $a = g_2/4$ Series near  $\omega_1$ 

## 18.5.56

$$\begin{aligned} (\mathcal{P} - e_1) = & (3e_1^2 - 5c_2)u + (10c_2 e_1 + 21c_3)u^2 + (7c_2 e_1^2 \\ & + 21c_3 e_1 + 5c_2^2)u^3 + (18c_3 e_1^2 + 30c_2^2 e_1 \\ & + 33c_2 c_3)u^4 + \left( 22c_2^2 e_1^2 + 92c_2 c_3 e_1 + 105c_3^2 \right. \\ & \left. - \frac{10c_2^3}{3} \right) u^5 + \left( \frac{728}{11} c_2 c_3 e_1^2 + \frac{220}{3} c_2^2 e_1 + 84c_3^2 e_1 \right. \\ & + \frac{1214}{11} c_2^3 c_3 \left. \right) u^6 + \left( \frac{635}{13} c_3^2 e_1^2 + \frac{855}{13} c_2^2 e_1^2 \right. \\ & \left. + \frac{3405}{11} c_2^2 c_3 e_1 + \frac{45750}{143} c_2 c_3^2 + \frac{25}{13} c_3^4 \right) u^7 + \dots \end{aligned}$$

## 18.5.57

where  $u=(z-\omega_1)^2$ Other Series Involving  $\mathcal{P}'$ Series near  $z_0$ 

## 18.5.58

$$\begin{aligned} (\mathcal{P}' - \mathcal{P}'_0) = & \left[ -10c_2 u - 56c_3 u^3 + 30c_2^2 u^5 + 264c_2 c_3 u^7 \right. \\ & + \frac{(840c_3^2 - 100c_2^2)}{3} u^9 - \frac{5452c_2^2 c_3}{11} u^{11} \\ & \left. + \frac{70c_2(55c_3^2 - 2316c_2^2)u^{13}}{143} \right] \\ & + \mathcal{P}'_0 \left[ -15c_2 u^4 - 28c_3 u^6 + 30c_2^2 u^8 + 114c_2 c_3 u^{10} \right. \\ & \left. + 7(12c_3^2 - 5c_2^2)u^{12} - \frac{2440c_2^2 c_3}{11} u^{14} \right] + \dots \end{aligned}$$

## 18.5.59

where  $u=(z-z_0)$ 

## 18.5.60

$$\begin{aligned} (z - z_0) = & A - bA^3 - \frac{3\mathcal{P}'_0}{2} A^4 + 3(c_2 + b^2)A^5 \\ & + 10b \mathcal{P}'_0 A^6 - 3[36c_3 - 3\mathcal{P}'_0 + 4b^3]A^7 \\ & - 3\mathcal{P}'_0 \left( \frac{25}{2} c_2 + 21b^2 \right) A^8 + \frac{5}{12} (285b^2 c_2 \\ & + 100c_2^2 - 279\mathcal{P}'_0{}^2 b + 132b^4) A^9 + \dots \end{aligned}$$

## 18.5.61

where  $A = (\mathcal{P}' - \mathcal{P}'_0) / (-10c_2)$ 

## 18.5.62

and  $b = 4g_3/g_2$ Series near  $\omega_1$ 

## 18.5.63

$$\begin{aligned} \mathcal{P}' = & 2(3e_1^2 - 5c_2)\alpha + 4(10c_2 e_1 + 21c_3)\alpha^2 + 6(7c_2 e_1^2 \\ & + 21c_3 e_1 + 5c_2^2)\alpha^3 + 24(6c_3 e_1^2 + 10c_2^2 e_1 \\ & + 11c_2 c_3)\alpha^4 + 10 \left( 22c_2^2 e_1^2 + 92c_2 c_3 e_1 + 105c_3^2 \right. \\ & \left. - \frac{10c_2^3}{3} \right) \alpha^5 + 24 \left( \frac{364}{11} c_2 c_3 e_1^2 + \frac{110}{3} c_2^2 e_1 \right. \\ & + 42c_3^2 e_1 + \frac{607}{11} c_2^3 c_3 \left. \right) \alpha^{11} + 70 \left( \frac{127}{13} c_2^2 e_1^2 \right. \\ & \left. + \frac{171}{13} c_3^2 e_1^2 + \frac{681}{11} c_2^2 c_3 e_1 + \frac{9150}{143} c_2 c_3^2 + \frac{5}{13} c_3^4 \right) \alpha^{13} \\ & + \dots \end{aligned}$$

## 18.5.64

where  $\alpha = (z - \omega_1)$ .

Other Series Involving  $\zeta$

Series near  $z_0$  [ $\mathcal{P}(z_0)=0$ ]

18.5.65

$$\zeta - \zeta_0 = \mathcal{P}'_0 \left[ -\frac{u^2}{2} + \frac{c_2 u^6}{2} + \frac{c_3 u^8}{2} - \frac{c_2^2 u^{10}}{3} - \frac{19c_2 c_3 u^{12}}{22} + \frac{(5c_2^3 - 12c_3^2)}{26} u^{14} + \frac{61c_2^2 c_3 u^{16}}{66} \right] + \left[ \frac{5c_2 u^3}{3} + \frac{7c_3 u^5}{2} - \frac{5c_2^2 u^7}{7} - \frac{11c_2 c_3 u^9}{3} + \frac{(10c_2^3 - 84c_3^2)}{33} u^{11} + \frac{1363c_2^2 c_3}{429} u^{13} + \frac{c_2(2316c_2^2 - 55c_3^2)}{429} u^{15} \right] + \dots,$$

18.5.66 where  $u = (z - z_0)$ ,

18.5.67  $\zeta_0 \equiv \zeta(z_0)$

Series near  $\omega_i$

18.5.68

$$(\zeta - \eta_i) = -e_i \alpha - \frac{(3e_i^2 - 5c_2)}{3} \alpha^3 - \frac{(10c_2 e_i + 21c_3) \alpha^5}{5} - \frac{(7c_2 e_i^2 + 21c_3 e_i + 5c_2^2) \alpha^7}{7} - \frac{(6c_3 e_i^2 + 10c_2^2 e_i + 11c_2 c_3) \alpha^9}{3} - \frac{(22c_2^2 e_i^2 + 92c_2 c_3 e_i + 105c_3^2 - \frac{10}{3} c_2^3) \alpha^{11}}{11} - \frac{2}{13} \left( \frac{364}{11} c_2 c_3 e_i^2 + \frac{110}{3} c_2^2 e_i + 42c_3^2 e_i + \frac{607}{11} c_2^2 c_3 \right) \alpha^{13} - \frac{1}{3} \left( \frac{127}{13} c_2^2 e_i^2 + \frac{171}{13} c_2^2 c_3 \right) \alpha^{15} + \frac{681}{11} c_2^2 c_3 e_i + \frac{9150}{143} c_2 c_3^2 + \frac{5}{13} c_2^4 \alpha^{15} - \dots,$$

18.5.69

where  $\alpha = (z - \omega_i)$

Reversed Series for Small  $|\sigma|$

18.5.70

$$z = \sigma + \frac{\gamma_2}{5} \sigma^5 + \frac{\gamma_3}{7} \sigma^7 + \frac{3\gamma_2^2}{14} \sigma^9 + \frac{19\gamma_2 \gamma_3}{55} \sigma^{11} + \frac{3842\gamma_2^3 + 861\gamma_3^2}{6006} \sigma^{13} + \dots,$$

18.5.71

where  $\gamma_2 = g_2/48$

18.5.72

$\gamma_3 = g_3/120$

For reversion of Maclaurin series, see 3.6.25 and [18.18].

18.6. Derivatives and Differential Equations

Ordinary ( $c_2 = g_2/20, c_3 = g_3/28$ )

18.6.1

$$\zeta'(z) = -\mathcal{P}(z)$$

18.6.2

$$\sigma'(z)/\sigma(z) = \zeta(z)$$

18.6.3

$$\mathcal{P}''(z) = 4\mathcal{P}^3(z) - g_2\mathcal{P}(z) - g_3 = 4(\mathcal{P}^3 - 5c_2\mathcal{P} - 7c_3)$$

18.6.4

$$\mathcal{P}''(z) = 6\mathcal{P}^2(z) - \frac{1}{2}g_2 = 6\mathcal{P}^2 - 10c_2$$

18.6.5

$$\mathcal{P}'''(z) = 12\mathcal{P}\mathcal{P}'$$

18.6.6

$$\mathcal{P}^{(4)}(z) = 12(\mathcal{P}\mathcal{P}'' + \mathcal{P}'\mathcal{P}') = 5! \left[ \mathcal{P}^3 - 3c_2\mathcal{P} - \frac{14c_3}{5} \right]$$

18.6.7

$$\mathcal{P}^{(5)}(z) = 12(\mathcal{P}\mathcal{P}''' + 2\mathcal{P}'\mathcal{P}'' + \mathcal{P}''\mathcal{P}') = 3 \cdot 5! \mathcal{P}'[\mathcal{P}^2 - c_2]$$

18.6.8

$$\mathcal{P}^{(6)}(z) = 12(\mathcal{P}\mathcal{P}^{(4)} + 3\mathcal{P}'\mathcal{P}''' + 3\mathcal{P}''\mathcal{P}'' + \mathcal{P}''' \mathcal{P}') = 7! [\mathcal{P}^4 - 4c_2\mathcal{P}^2 - 4c_3\mathcal{P} + 5c_2^2/7]$$

18.6.9

$$\mathcal{P}^{(7)}(z) = 4 \cdot 7! \mathcal{P}'[\mathcal{P}^3 - 2c_2\mathcal{P} - c_3]$$

18.6.11

$$\mathcal{P}^{(8)}(z) = 9! [\mathcal{P}^5 - 5c_2\mathcal{P}^3 - 5c_3\mathcal{P}^2 + (10c_2^2\mathcal{P} + 11c_2c_3)/3]$$

18.6.12

$$\mathcal{P}^{(9)}(z) = 5 \cdot 9! \mathcal{P}'[\mathcal{P}^4 - 3c_2\mathcal{P}^2 - 2c_3\mathcal{P} + 2c_2^2/3]$$

18.6.13

$$\mathcal{P}^{(10)}(z) = 11! [\mathcal{P}^6 - 6c_2\mathcal{P}^4 - 6c_3\mathcal{P}^3 + 7c_2^2\mathcal{P}^2 + (342c_2c_3\mathcal{P} + 84c_2^2 - 10c_3^2)/33]$$

18.6.14

$$\mathcal{P}^{(11)}(z) = 6 \cdot 11! \mathcal{P}'[\mathcal{P}^5 - 4c_2\mathcal{P}^3 - 3c_3\mathcal{P}^2 + (77c_2^2\mathcal{P} + 57c_2c_3)/33]$$

18.6.15

$$\mathcal{P}^{(12)}(z) = 13! [\mathcal{P}^7 - 7c_2\mathcal{P}^5 - 7c_3\mathcal{P}^4 + 35c_2^2\mathcal{P}^3/3 + 210c_2c_3\mathcal{P}^2/11 + (84c_3^2 - 35c_2^3)\mathcal{P}/13 - 1363c_2^2c_3/429]$$

18.6.16

$$\mathcal{P}^{(13)}(z) = 7 \cdot 13! \mathcal{P}'[\mathcal{P}^6 - 5c_2\mathcal{P}^4 - 4c_3\mathcal{P}^3 + 5c_2^2\mathcal{P}^2 + 60c_2c_3\mathcal{P}/11 + (12c_3^2 - 5c_2^3)/13]$$

18.6.17

$$\mathcal{P}^{(14)}(z) = 15! [\mathcal{P}^8 - 8c_2\mathcal{P}^6 - 8c_3\mathcal{P}^5 + 52c_2^2\mathcal{P}^4/3 + 328c_2c_3\mathcal{P}^3/11 + (444c_3^2 - 328c_2^3)\mathcal{P}^2/39 - 488c_2^2c_3\mathcal{P}/33 + c_2(55c_3^2 - 2316c_2^3)/429]$$

18.6.18

$$\mathcal{P}^{(15)}(z) = 8 \cdot 15! \mathcal{P}'[\mathcal{P}^7 - 6c_2\mathcal{P}^5 - 5c_3\mathcal{P}^4 + 26c_2^2\mathcal{P}^3/3 + 123c_2c_3\mathcal{P}^2/11 + (111c_3^2 - 82c_2^3)\mathcal{P}/39 - 61c_2^2c_3/33]$$

Partial Derivatives with Respect to Invariants

18.6.19

$$\Delta \frac{\partial \mathcal{P}}{\partial g_3} = \mathcal{P}' \left( 3g_2 \zeta - \frac{9}{2} g_3 z \right) + 6g_2 \mathcal{P}^2 - 9g_3 \mathcal{P} - g_2^2$$

18.6.20

$$\Delta \frac{\partial \mathcal{P}}{\partial g_2} = \mathcal{P}' \left( -\frac{9}{2} g_3 \zeta + \frac{g_2^2 z}{4} \right) - 9g_3 \mathcal{P}^2 + \frac{g_2^2}{2} \mathcal{P} + \frac{3}{2} g_2 g_3$$

18.6.21

$$\Delta \frac{\partial \zeta}{\partial g_3} = -3\zeta \left( g_2 \mathcal{P} + \frac{3}{2} g_3 \right) + \frac{1}{2} z \left( 9g_3 \mathcal{P} + \frac{1}{2} g_2^2 \right) - \frac{3}{2} g_2 \mathcal{P}'$$

18.6.22

$$\Delta \frac{\partial \zeta}{\partial g_2} = \frac{1}{2} \zeta \left( 9g_3 \mathcal{P} + \frac{1}{2} g_2^2 \right) - \frac{1}{2} g_2 z \left( \frac{1}{2} g_2 \mathcal{P} + \frac{3}{4} g_3 \right) + \frac{9}{4} g_3 \mathcal{P}'$$

18.6.23  $\Delta \frac{\partial \sigma}{\partial g_3} = \frac{3}{2} g_2 \sigma'' + \frac{9}{2} g_3 \sigma + \frac{1}{8} g_2^2 z^2 \sigma - \frac{9}{2} g_2 z \sigma'$

18.6.24

$$\Delta \frac{\partial \sigma}{\partial g_2} = -\frac{9}{4} g_3 \sigma'' - \frac{1}{4} g_2^2 \sigma - \frac{3}{16} g_2 g_3 z^2 \sigma + \frac{1}{4} g_2^2 z \sigma'$$

(here ' denotes  $\frac{\partial}{\partial z}$ )

Differential Equations

18.6.25

| <i>Equation</i>     | <i>Solution</i>  |
|---------------------|--|
| $y'^3 = y^2(y-a)^2$ | $y = \frac{a}{2} + \frac{27}{16} \mathcal{P}' \left( \frac{z}{2}; 0, -\frac{64a^2}{729} \right)$ |

18.6.26

|                               |   |
|-------------------------------|---|
| $y'^3 = (y^3 - 3ay^2 + 3y)^2$ | $y = \frac{2}{a - 3 \mathcal{P}'(z; 0, g_3)}$ |
|                               | $g_3 = \frac{4 - 3a^2}{27}$                   |

18.6.27

|  |                                       |
|--|---------------------------------------|
| $y'^4 = \frac{128}{3} (y+a)^2 (y+b)^3$ | $y = 6 \mathcal{P}^2(z; g_2, 0) - b,$ |
|  | $g_2 = -\frac{2}{3} (a-b)$            |

$y'' = [a \mathcal{P}(z) + b]y$  (Lamé's equation)—see [18.8], 2.26

For other (more specialized) equations (of orders 1-3) involving  $\mathcal{P}(z)$ , see [18.8], nos. 1.49, 2.28, 2.72-3, 2.439-440, 3.9-12.

For the use of  $\mathcal{P}(z)$  in solving differential equations of the form  $y'^m + A(z,y) = 0$ , where  $A(z,y)$  is a polynomial in  $y$  of degree  $2m$ , with coefficients which are analytic functions of  $z$ , see [18.7], p. 312ff.

18.7. Integrals

*Indefinite*

18.7.1  $\int \mathcal{P}^2(z) dz = \frac{1}{6} \mathcal{P}'(z) + \frac{1}{12} g_2 z$

18.7.2  $\int \mathcal{P}^3(z) dz = \frac{1}{120} \mathcal{P}'''(z) - \frac{3}{20} g_2 \zeta(z) + \frac{1}{10} g_3 z$

(formulas for higher powers may be derived by integration of formulas for  $\mathcal{P}^{(2k)}(z)$ )

For  $\int \mathcal{P}^n(z) dz$ ,  $n$  any positive integer, see [18.15] vol. 4, pp. 108-9.

If  $\mathcal{P}'(a) \neq 0$

18.7.3

$$\mathcal{P}'(a) \int \frac{dz}{\mathcal{P}(z) - \mathcal{P}(a)} = 2z\zeta(a) + \ln \sigma(z-a) - \ln \sigma(z+a)$$

For  $\int dz / [\mathcal{P}(z) - \mathcal{P}(a)]^n$ , ( $\mathcal{P}'(a) \neq 0$ )  $n$  any positive integer, see [18.15], vol. 4, pp. 109-110.

*Definite*

$\Delta > 0$                        $\Delta < 0$

18.7.4

$$\omega = \int_{e_1}^{\infty} \frac{dt}{\sqrt{s(t)}} \quad \omega_2 = \int_{e_2}^{\infty} \frac{dt}{\sqrt{s(t)}}$$

18.7.5

$$\omega' = i \int_{-\infty}^{e_3} \frac{dt}{\sqrt{|s(t)|}} \quad \omega'_2 = i \int_{-\infty}^{e_2} \frac{dt}{\sqrt{|s(t)|}}$$

18.7.6

where  $t$  is real and

18.7.7

$s(t) = 4t^3 - g_2 t - g_3$

18.8 Conformal Mapping

$w = u + iv$

$\Delta > 0$

$\Delta < 0$

$w = \wp(z)$  maps the Fundamental Rectangle onto the half-plane  $v \leq 0$ ; if  $|\omega'| = \omega_3 (g_3 = 0)$ , the isosceles triangle  $0\omega\omega_2$  is mapped onto  $u \geq 0, v \leq 0$ .

$w = \wp(z)$  maps the Fundamental Rectangle onto the half-plane  $v \leq 0$ ; if  $|\omega'_2| = \omega_2 (g_3 = 0)$ , the isosceles triangle  $0\omega_2\omega'$  is mapped onto  $u \geq 0, v \leq 0$ .

$w = \wp'(z)$  maps the Fundamental Rectangle onto the  $w$ -plane less quadrant III; if  $|\omega'| = \omega$ , the triangle  $0\omega\omega_2$  is mapped onto  $v \geq 0, v \geq u$ .

$w = \wp'(z)$  maps the Fundamental Rectangle onto most of the  $w$ -plane less quadrant III; if  $|\omega'_2| = \omega_2$ , the triangle  $0\omega_2\omega'$  is mapped onto  $v \geq 0, v \geq u$ .

( $a = \text{period ratio}$ )

$w = \zeta(z)$  maps the Fundamental Rectangle onto the half-plane  $u \geq 0$ . If  $a \leq 1.9$  (approx.),  $v \leq 0$ ; otherwise the image extends into quadrant I. For very large  $a$ , the image has a large area in quadrant I.

$w = \zeta(z)$  maps the Fundamental Rectangle onto the half-plane  $u \geq 0$ . The image is mostly in quadrant IV for small  $a$ , entirely so for (approx.)  $1.3 \leq a \leq 3.8$ . For very large  $a$ , the image has a large area in quadrant I.

$w = \sigma(z)$  maps the Fundamental Rectangle onto quadrant I if  $a < 1.9$  (approx.), onto quadrants I and II if  $1.9 \leq a < 3.8$  (approx.). For large  $a$ ,  $\arg[\sigma(\omega_2)] \approx \frac{\pi^2 a}{12}$ ; consequently the image winds around the origin for large  $a$ .

$w = \sigma(z)$  maps the Fundamental Rectangle onto quadrant I if  $a < 3.8$  (approx.), onto quadrants I and II if  $3.8 \leq a < 7.6$  (approx.). For large  $a$ ,  $\arg\left[\sigma\left(\omega_2 + \frac{\omega'_2}{2}\right)\right] \approx \frac{\pi^2 a}{24}$ ; consequently the image winds around the origin for large  $a$ .

Other maps are described in [18.23] arts. 13.7 (square on circle), 13.11 (ring on plane with 2 slits in line) and in [18.24], p. 35 (double half equilateral triangle on half-plane).

Other maps are described in [18.23] arts. 13.8 (equilateral triangle on half-plane) and 13.9 (isosceles triangle on half-plane).

Obtaining  $\wp'$  from  $\wp'^3$

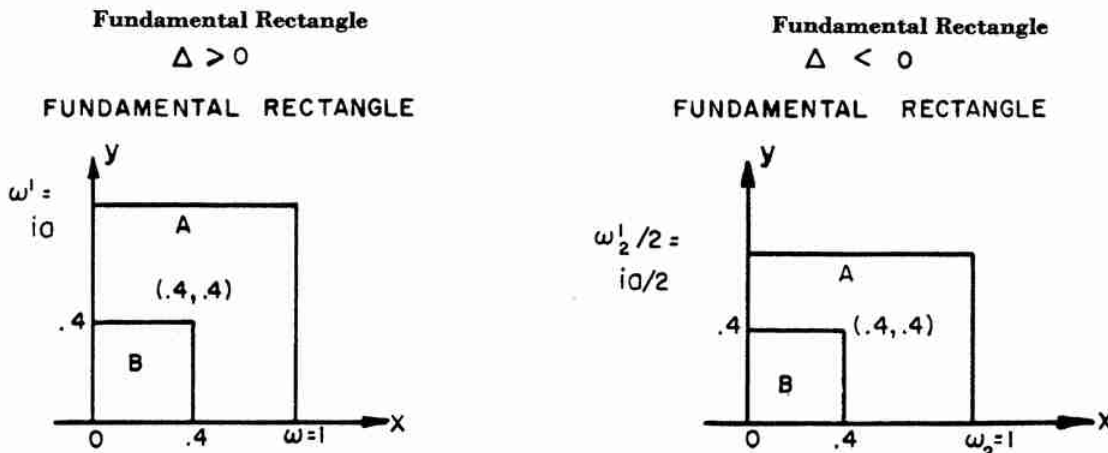

FIGURE 18.4

In region A

In region A

$\Re(\wp') \geq 0$  if  $y \geq .4$  and  $x \leq .5$ ;  $\Im(\wp') \geq 0$  elsewhere

(1) If  $a \geq 1.05$ , use criterion for region A for  $\Delta > 0$ .

(2) If  $1 \leq a < 1.05$ :  $\Re(\wp') \geq 0$  if  $y \geq .4$  and  $x \leq .4$ ,  $-\pi/4 < \arg(\wp') < 3\pi/4$  if  $.4 < y \leq .5$  and  $.4 < x \leq .5$ .  $\Im(\wp') \geq 0$  elsewhere

In region B

The sign (indeed, perhaps one or more significant digits) of  $\mathcal{P}'$  is obtainable from the first term,  $-2/z^3$ , of the Laurent series for  $\mathcal{P}'$ .

(Precisely similar criteria apply when the real half-period  $\neq 1$ )

$$\Delta > 0 \quad \omega = 1$$

$$\text{Map: } \mathcal{P}(z) = u + iv$$

$$\text{Near zero: } \mathcal{P}(z) = \frac{1}{z^2} + \epsilon_1$$

$$\mathcal{P}(z) = \frac{1}{z^2} + c_2 z^2 + \epsilon_2$$

$$\omega' = i$$

In region B

Use the criterion for region B for  $\Delta > 0$ .

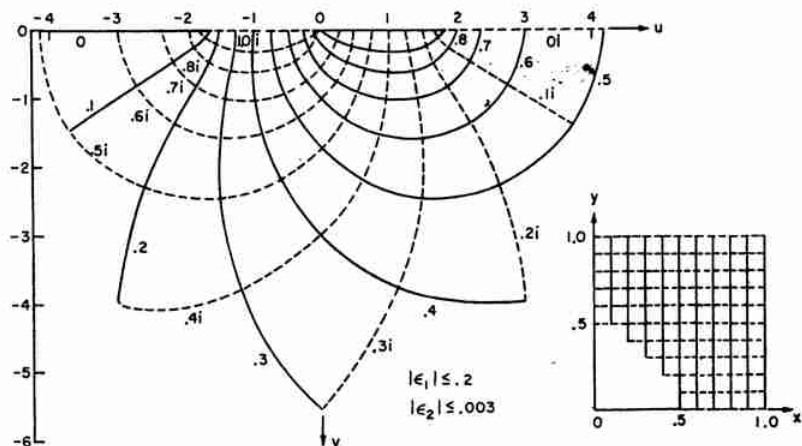

$$\omega' = 1.4i$$

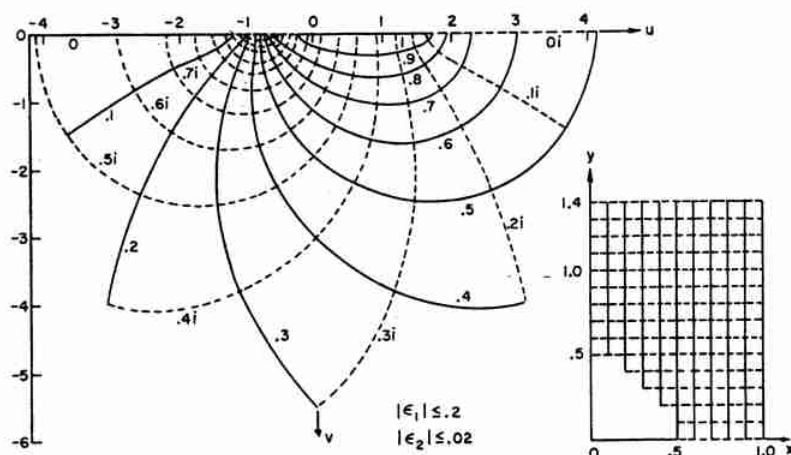

$$\omega' = 2.0i$$

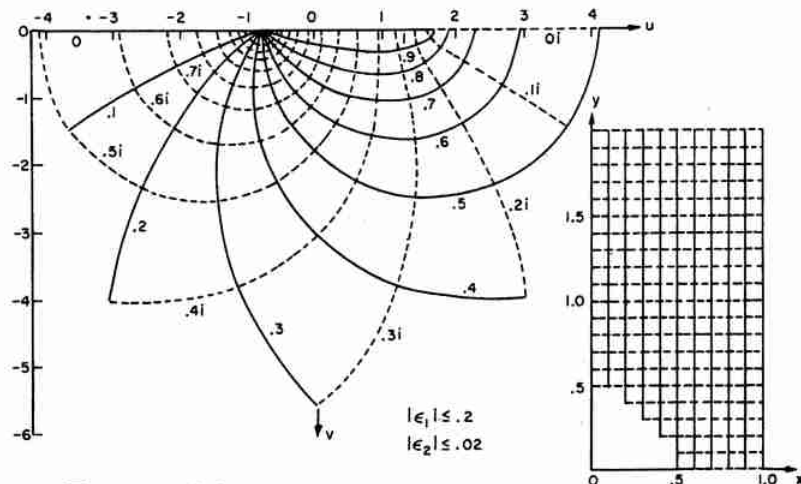

FIGURE 18.5

$$\Delta < 0 \quad \omega_2 = 1$$

Map:  $\mathcal{P}(z) = u + iv$

Near zero:  $\mathcal{P}(z) = \frac{1}{z^2} + \epsilon_1$

$$\mathcal{P}(z) = \frac{1}{z^2} + c_2 z^2 + \epsilon_2$$

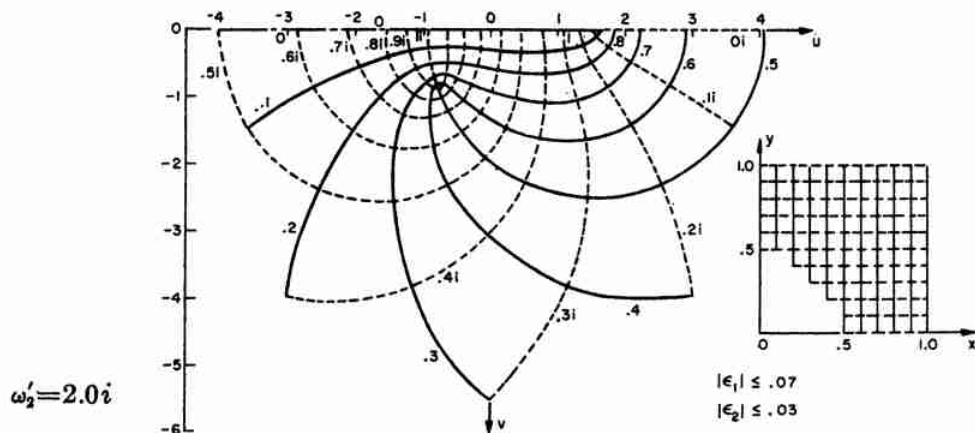
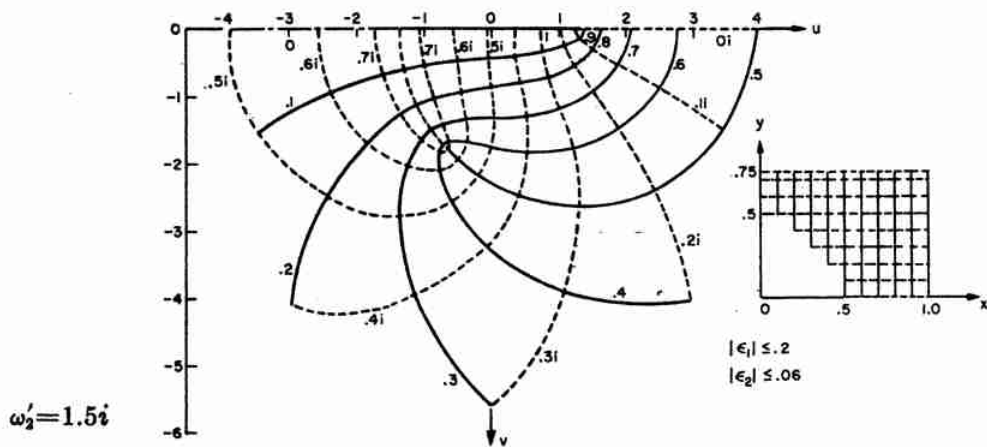
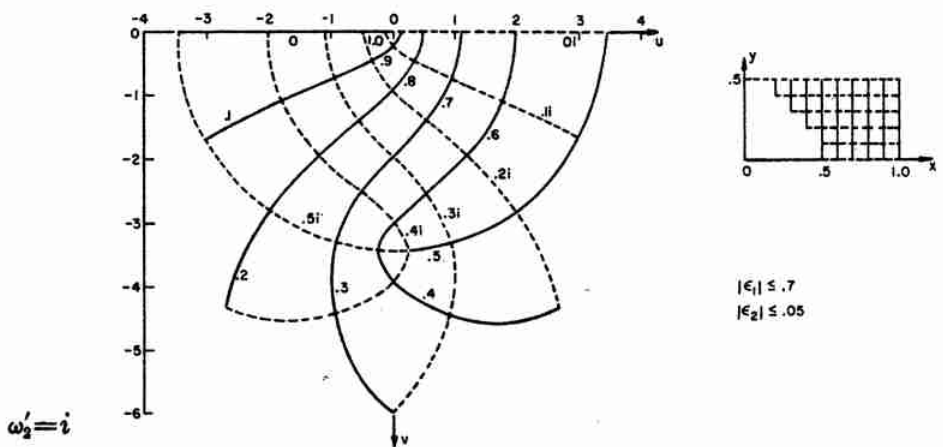

FIGURE 18.6



$$\Delta > 0 \quad \omega = 1$$

$$\text{Map: } \zeta(z) = u + iv$$

$$\text{Near zero: } \zeta(z) = \frac{1}{z} + \epsilon_1$$

$$\zeta(z) = \frac{1}{z} - \frac{c_2 z^3}{3} + \epsilon_2$$

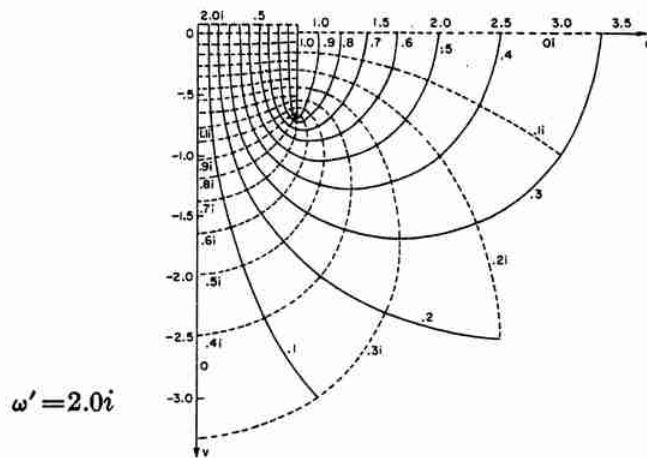
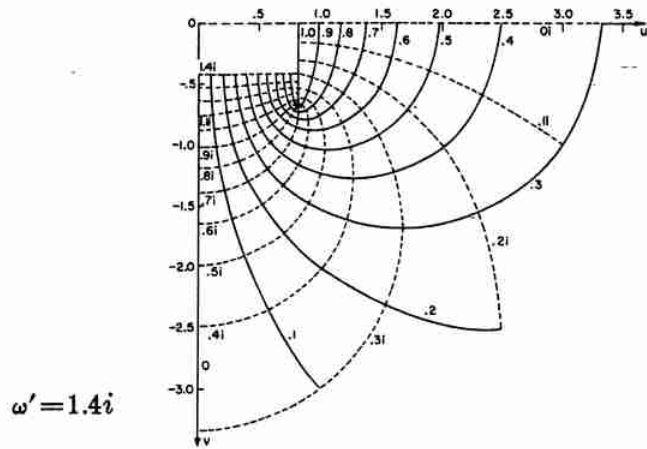
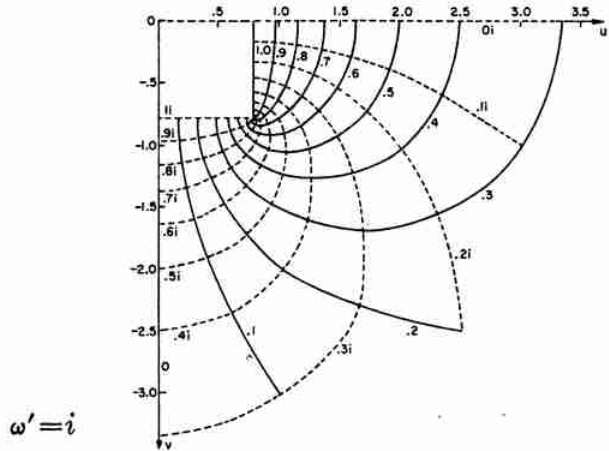

FIGURE 18.7

$$\Delta < 0 \quad \omega_2 = 1$$

$$\text{Map: } f(z) = u + iv$$

$$\text{Near zero: } f(z) = \frac{1}{z} + \epsilon_1$$

$$f(z) = \frac{1}{z} - \frac{c_2 z^3}{3} + \epsilon_2$$

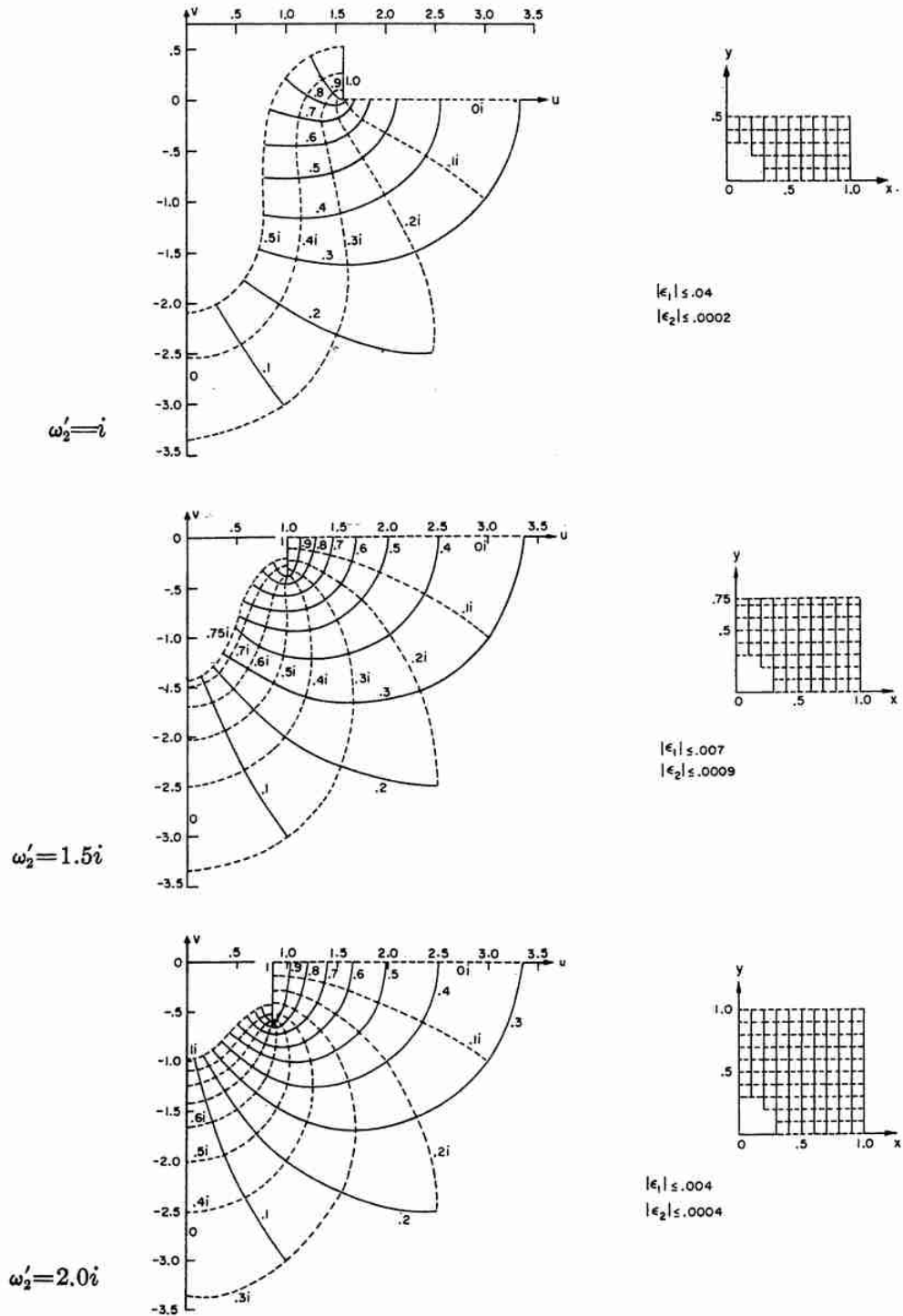

FIGURE 18.8

$$\Delta > 0 \quad \omega = 1$$

$$\text{Map: } \sigma(z) = u + iv$$

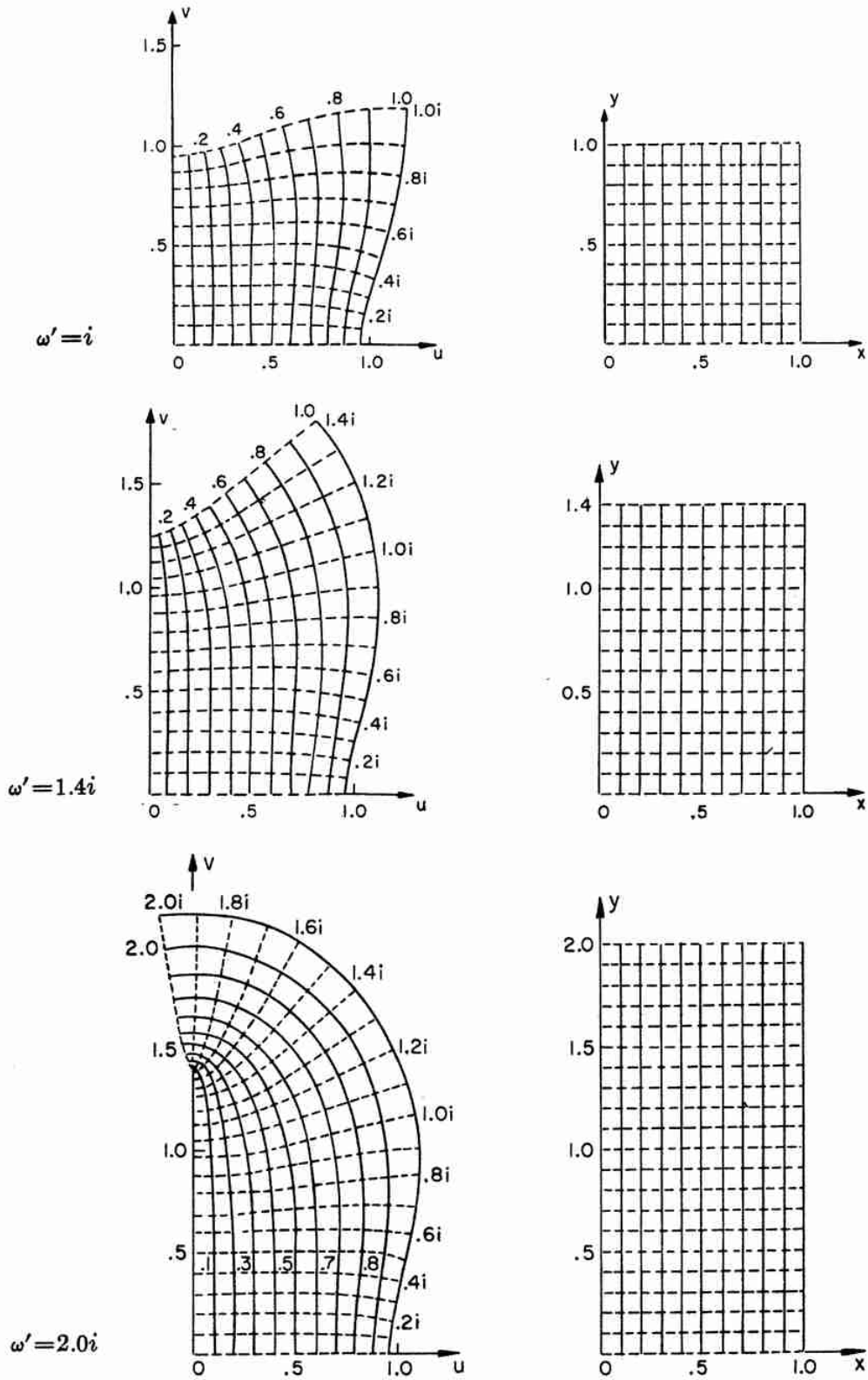

FIGURE 18.9

$$\Delta < 0 \quad \omega_2 = 1$$

$$\text{Map: } \sigma(z) = u + iv$$

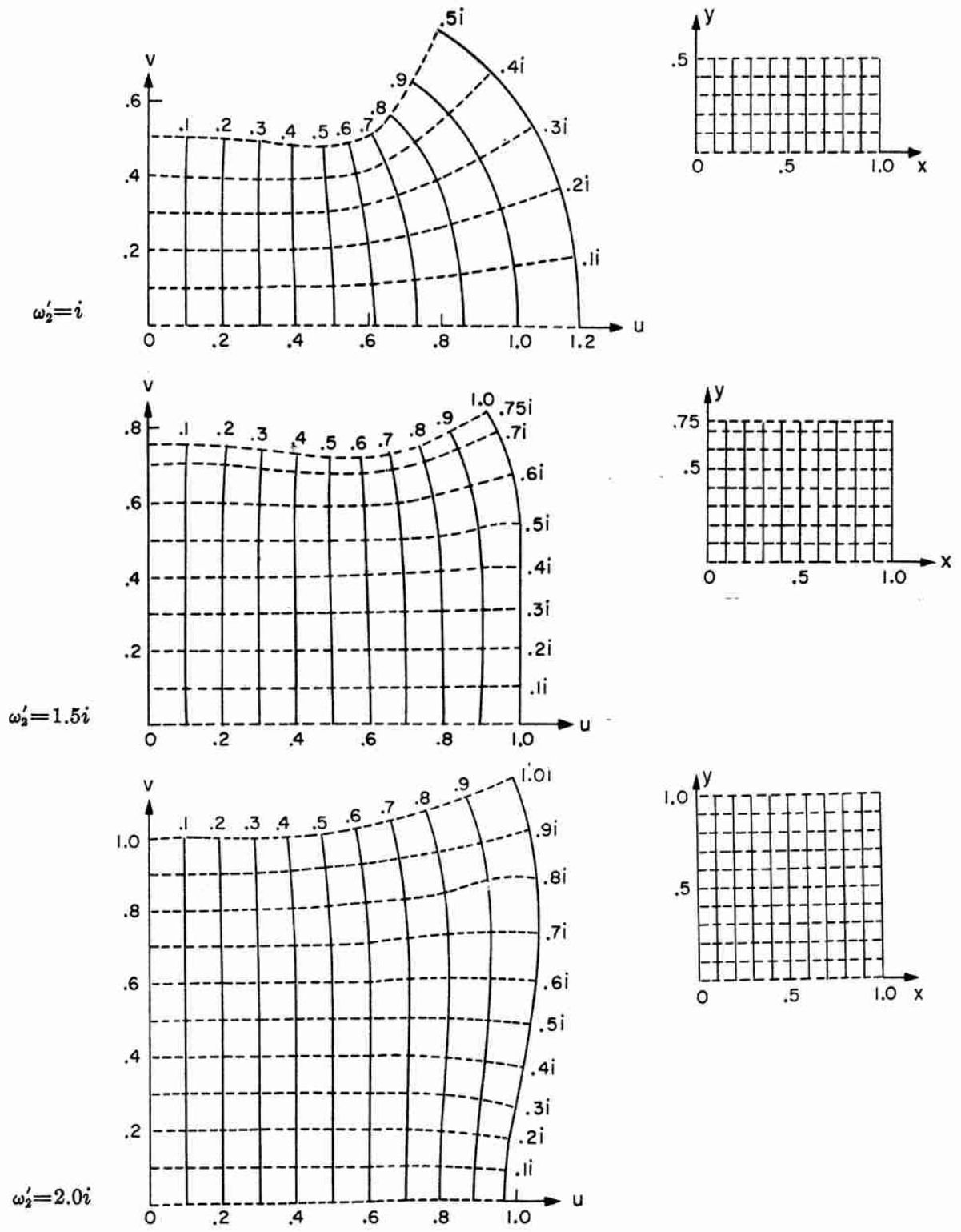

FIGURE 18.10

18.9. Relations with Complete Elliptic Integrals  $K$  and  $K'$  and Their Parameter  $m$   
and with Jacobi's Elliptic Functions (see chapter 16)

(Here  $K(m)$  and  $K'(m) = K(1-m)$  are complete elliptic integrals of the 1st kind; see chapter 17.)

$$\Delta > 0$$

$$\Delta < 0$$

$$18.9.1 \quad e_1 = \frac{(2-m)K^2(m)}{3\omega^2}$$

$$e_1 = \frac{(2m-1) + 6i\sqrt{m-m^2}}{3\omega_2^2} \cdot K^2(m)$$

$$18.9.2 \quad e_2 = \frac{(2m-1)K^2(m)}{3\omega^2}$$

$$e_2 = \frac{2(1-2m)K^2(m)}{3\omega_2^2}$$

$$18.9.3 \quad e_3 = \frac{-(m+1)K^2(m)}{3\omega^2}$$

$$e_3 = \frac{(2m-1) - 6i\sqrt{m-m^2}}{3\omega_2^2} \cdot K^2(m)$$

$$18.9.4 \quad g_2 = \frac{4(m^2-m+1)K^4(m)}{3\omega^4}$$

$$g_2 = \frac{4(16m^2-16m+1)K^4(m)}{3\omega_2^4}$$

$$18.9.5 \quad g_3 = \frac{4(m-2)(2m-1)(m+1)K^6(m)}{27\omega^6}$$

$$g_3 = \frac{8(2m-1)(32m^2-32m-1)K^6(m)}{27\omega_2^6}$$

$$18.9.6 \quad \Delta = \frac{16m^2(m-1)^2K^{12}(m)}{\omega^{12}}$$

$$\Delta = \frac{-256(m-m^2)K^{12}(m)}{\omega_2^{12}}$$

$$18.9.7 \quad \omega' = \frac{iK'(m)\omega}{K(m)}$$

$$\omega_2' = \frac{iK'(m)\omega_2}{K(m)}$$

$$18.9.8 \quad \omega = K(m)/(e_1 - e_3)^{1/2}$$

$$\omega_2 = K(m)/H_2^{1/2}$$

$$18.9.9 \quad m = (e_2 - e_3)/(e_1 - e_3)$$

$$m = \frac{1}{2} - \frac{3e_2}{4H_2}$$

$$18.9.10 \quad [0 < m \leq \frac{1}{2}, \text{ since } g_3 \geq 0]$$

$$18.9.11 \quad \mathcal{P}(z) = e_3 + (e_1 - e_3)/\text{sn}^2(z^*|m)$$

$$\mathcal{P}(z) = e_2 + H_2 \frac{1 + \text{cn}(z'|m)}{1 - \text{cn}(z'|m)}$$

18.9.12

$$\mathcal{P}'(z) = -2(e_1 - e_3)^{3/2} \cdot \text{cn}(z^*|m) \text{dn}(z^*|m) / \text{sn}^3(z^*|m)$$

$$\mathcal{P}'(z) = \frac{-4H_2^{3/2} \text{sn}(z'|m) \text{dn}(z'|m)}{[1 - \text{cn}(z'|m)]^2}$$

where

$$z^* = (e_1 - e_3)^{1/2} z$$

where

$$z' = 2zH_2^{1/2}$$

$$18.9.13 \quad \eta = \zeta(\omega) = \frac{K(m)}{3\omega} [3E(m) + (m-2)K(m)]$$

$$\eta_2 = \zeta(\omega_2) = \frac{K(m)}{3\omega_2} [6E(m) + (4m-5)K(m)]$$

$$18.9.14 \quad \eta' = \zeta(\omega') = \frac{\eta\omega' - \frac{1}{2}\pi i}{\omega}$$

$$\eta_2' = \zeta(\omega_2') = \frac{\eta_2\omega_2' - \pi i}{\omega_2}$$

[ $E(m)$  is a complete elliptic integral of the 2d kind (see chapter 17).]

## 18.10. Relations with Theta Functions (chapter 16)

The formal definitions of the four  $\vartheta$  functions are given by the series 16.27.1–16.27.4 which converge for all complex  $z$  and all  $q$  defined below. (Some authors use  $\pi z$ , instead of  $z$ , as the independent variable.) These functions depend on  $z$  and on a parameter  $q$ , which is usually suppressed. Note that

$$\vartheta_1'(0) = \vartheta_2(0)\vartheta_3(0)\vartheta_4(0), \text{ where } \vartheta_i(0) = \vartheta_i(0, q).$$

|          |  |  |
|----------|--|--|
|          | $\Delta > 0$   | $\Delta < 0$   |
| 18.10.1  | $\tau = \omega'/\omega$  | $\tau_2 = \omega_2'/2\omega_2$   |
| 18.10.2  | $q = e^{i\pi\tau} = e^{-\pi K'/K}$   | $q = iq_2 = ie^{i\pi\tau_2} = ie^{-\pi i\omega_2'/2\omega_2}$  |
| 18.10.3  | $q$ is real and since $g_3 \geq 0$ ( $ \omega'  \geq \omega$ ), $0 < q \leq e^{-\pi}$  | $q$ is pure imaginary and since $g_3 \geq 0$ ( $ \omega_2'  \geq \omega_2$ ), $0 <  q  \leq e^{-\pi/2}$  |
| 18.10.4  | $(v = \pi z/2\omega)$  | $(v = \pi z/2\omega_2)$  |
| 18.10.5  | $\mathcal{P}(z) = e_j + \frac{\pi^2}{4\omega^2} \left[ \frac{\vartheta_1'(0)\vartheta_{j+1}(v)}{\vartheta_{j+1}(0)\vartheta_1(v)} \right]^2$<br>$j=1, 2, 3$                | $\mathcal{P}(z) = e_2 + \frac{\pi^2}{4\omega_2^2} \left[ \frac{\vartheta_1'(0)\vartheta_2(v)}{\vartheta_2(0)\vartheta_1(v)} \right]^2$                                       |
| 18.10.6  | $\mathcal{P}'(z) = -\frac{\pi^3}{4\omega^3} \frac{\vartheta_2(v)\vartheta_3(v)\vartheta_4(v)\vartheta_1^3(0)}{\vartheta_2(0)\vartheta_3(0)\vartheta_4(0)\vartheta_1^3(v)}$ | $\mathcal{P}'(z) = -\frac{\pi^3}{4\omega_2^3} \frac{\vartheta_2(v)\vartheta_3(v)\vartheta_4(v)\vartheta_1^3(0)}{\vartheta_2(0)\vartheta_3(0)\vartheta_4(0)\vartheta_1^3(v)}$ |
| 18.10.7  | $\zeta(z) = \frac{\eta z}{\omega} + \frac{\pi\vartheta_1'(v)}{2\omega\vartheta_1(v)}$  | $\zeta(z) = \frac{\eta_2 z}{\omega_2} + \frac{\pi\vartheta_1'(v)}{2\omega_2\vartheta_1(v)}$  |
| 18.10.8  | $\sigma(z) = \frac{2\omega}{\pi} \exp\left(\frac{\eta z^2}{2\omega}\right) \frac{\vartheta_1(v)}{\vartheta_1'(0)}$   | $\sigma(z) = \frac{2\omega_2}{\pi} \exp\left(\frac{\eta_2 z^2}{2\omega_2}\right) \frac{\vartheta_1(v)}{\vartheta_1'(0)}$   |
| 18.10.9  | $12\omega^2 e_1 = \pi^2[\vartheta_3^4(0) + \vartheta_4^4(0)]$  | $12\omega_2^2 e_1 = \pi^2[\vartheta_2^4(0) - \vartheta_4^4(0)]$  |
| 18.10.10 | $12\omega^2 e_2 = \pi^2[\vartheta_2^4(0) - \vartheta_4^4(0)]$  | $12\omega_2^2 e_2 = \pi^2[\vartheta_3^4(0) + \vartheta_4^4(0)]$  |
| 18.10.11 | $12\omega^2 e_3 = -\pi^2[\vartheta_2^4(0) + \vartheta_3^4(0)]$   | $12\omega_2^2 e_3 = -\pi^2[\vartheta_2^4(0) + \vartheta_3^4(0)]$   |
| 18.10.12 | $(e_2 - e_3)^{\frac{1}{2}} = -i(e_3 - e_2)^{\frac{1}{2}} = \frac{\pi}{2\omega} \vartheta_2^2(0)$   | $(e_2 - e_3)^{\frac{1}{2}} = i(e_3 - e_2)^{\frac{1}{2}} = \frac{\pi}{2\omega_2} \vartheta_3^2(0)$  |
| 18.10.13 | $(e_1 - e_3)^{\frac{1}{2}} = -i(e_3 - e_1)^{\frac{1}{2}} = \frac{\pi}{2\omega} \vartheta_3^2(0)$   | $(e_1 - e_3)^{\frac{1}{2}} = i(e_3 - e_1)^{\frac{1}{2}} = \frac{\pi}{2\omega_2} \vartheta_2^2(0)$  |
| 18.10.14 | $(e_1 - e_2)^{\frac{1}{2}} = -i(e_2 - e_1)^{\frac{1}{2}} = \frac{\pi}{2\omega} \vartheta_4^2(0)$   | $(e_2 - e_1)^{\frac{1}{2}} = -i(e_1 - e_2)^{\frac{1}{2}} = \frac{\pi}{2\omega_2} \vartheta_4^2(0)$   |
| 18.10.15 | $g_2 = \frac{2}{3} \left(\frac{\pi}{2\omega}\right)^4 [\vartheta_2^8(0) + \vartheta_3^8(0) + \vartheta_4^8(0)]$  | $g_2 = \frac{2}{3} \left(\frac{\pi}{2\omega_2}\right)^4 [\vartheta_2^8(0) + \vartheta_3^8(0) + \vartheta_4^8(0)]$  |
| 18.10.16 | $g_3 = 4e_1 e_2 e_3$   | $g_3 = 4e_1 e_2 e_3$   |
| 18.10.17 | $\Delta^{\frac{1}{2}} = \frac{\pi^3}{4\omega^3} \vartheta_1'^2(0)$   | $(-\Delta)^{\frac{1}{2}} = \frac{\pi^3}{4\omega_2^3} \vartheta_1'^2(0) e^{-i\pi/4}$  |
| 18.10.18 | $\eta \equiv \zeta(\omega) = -\frac{\pi^2 \vartheta_1'''(0)}{12\omega \vartheta_1'(0)}$  | $\eta_2 \equiv \zeta(\omega_2) = -\frac{\pi^2 \vartheta_1'''(0)}{12\omega_2 \vartheta_1'(0)}$  |
| 18.10.19 | $\eta' \equiv \zeta(\omega') = \frac{\eta\omega' - \frac{1}{2}\pi i}{\omega}$  | $\eta_2' \equiv \zeta(\omega_2') = \frac{\eta_2\omega_2' - \pi i}{\omega_2}$   |

## Series

- 18.10.20  $\vartheta_1(0)=0$
- 18.10.21  $\vartheta_2(0)=2q^{\frac{1}{2}}[1+q^{1\cdot 2}+q^{2\cdot 3}+q^{3\cdot 4}+\dots+q^{n(n+1)}+\dots]$
- 18.10.22  $\vartheta_3(0)=1+2[q+q^4+q^9+\dots+q^{n^2}+\dots]$
- 18.10.23  $\vartheta_4(0)=1+2[-q+q^4-q^9+\dots+(-1)^n q^{n^2}+\dots]$

## Attainable Accuracy

 $\Delta > 0$  $\Delta < 0$ Note:  $\vartheta_j(0) > 0, j=2, 3, 4$ Note:  $\vartheta_2(0)=Ae^{i\pi/8}, A > 0;$ 

$$\Re \vartheta_3(0) > 0; \vartheta_4(0) = \overline{\vartheta_3(0)}$$

 $\vartheta_j(0):$  2 terms give at least 5S

2 terms give at least 3S

 $j=2, 3, 4$  3 terms give at least 11S

3 terms give at least 5S

4 terms give at least 21S

4 terms give at least 10S

18.11 Expressing any Elliptic Function in Terms of  $\mathcal{P}$  and  $\mathcal{P}'$ If  $f(z)$  is any elliptic function and  $\mathcal{P}(z)$  has same periods, write

18.11.1 
$$f(z) = \frac{1}{2}[f(z) + f(-z)] + \frac{1}{2}[\{f(z) - f(-z)\} \{\mathcal{P}'(z)\}^{-1}] \mathcal{P}'(z).$$

Since both brackets represent even elliptic functions, we ask how to express an even elliptic function  $g(z)$  (of order  $2k$ ) in terms of  $\mathcal{P}(z)$ . Because of the evenness, an irreducible set of zeros can be denoted by  $a_i$  ( $i=1, 2, \dots, k$ ) and the set of points congruent to  $-a_i$  ( $i=1, 2, \dots, k$ ); correspondingly in connection with the poles we consider the points  $\pm b_i, i=1, 2, \dots, k$ . Then

18.11.2 
$$g(z) = A \prod_{i=1}^k \left\{ \frac{\mathcal{P}(z) - \mathcal{P}(a_i)}{\mathcal{P}(z) - \mathcal{P}(b_i)} \right\}, \text{ where } A \text{ is}$$

a constant. If any  $a_i$  or  $b_i$  is congruent to the origin, the corresponding factor is omitted from the product. Factors corresponding to multiple poles (zeros) are repeated according to the multiplicity.

18.12. Case  $\Delta=0(c>0)$ 

Subcase I

18.12.1  $g_2 > 0, g_3 < 0: (e_1=e_2=c, e_3=-2c)$

18.12.2  $H_1=H_2=0, H_3=3c$

18.12.3

$$\mathcal{P}(z; 12c^2, -8c^3) = c + 3c \{ \sinh [(3c)^{\frac{1}{2}} z] \}^{-2}$$

18.12.4

$$\zeta(z; 12c^2, -8c^3) = -cz + (3c)^{\frac{1}{2}} \coth [(3c)^{\frac{1}{2}} z]$$

18.12.5

$$\sigma(z; 12c^2, -8c^3) = (3c)^{-\frac{1}{2}} \sinh [(3c)^{\frac{1}{2}} z] e^{-cz^2/2}$$

18.12.6  $\omega = \infty, \omega' = (12c)^{-\frac{1}{2}} \pi i$

18.12.7  $\eta = \zeta(\omega) = -\infty$

18.12.8  $\eta' = \zeta(\omega') = -c\omega'$

18.12.9  $q=1, m=1$

18.12.10  $\sigma(\omega) = 0$

18.12.11  $\sigma(\omega') = \frac{2\omega' e^{\pi^2/24}}{\pi}$

18.12.12  $\sigma(\omega_2) = 0$

18.12.13  $\mathcal{P}(\omega/2) = c$

18.12.14  $\mathcal{P}'(\omega/2) = 0$

18.12.15  $\zeta(\omega/2) = -\infty$

18.12.16  $\sigma(\omega/2) = 0$

18.12.17  $\mathcal{P}(\omega'/2) = -5c$

18.12.18  $\mathcal{P}'(\omega'/2) = \frac{-\pi^3}{2\omega'^3}$

18.12.19  $\zeta(\omega'/2) = \frac{1}{2}(-c\omega' + \pi/\omega')$



- 18.12.20  $\sigma(\omega'/2) = \frac{\omega' e^{\pi^2/96} \sqrt{2}}{\pi}$
- 18.12.21  $\mathcal{P}(\omega_2/2) = c$
- 18.12.22  $\mathcal{P}'(\omega_2/2) = 0$
- 18.12.23  $\zeta(\omega_2/2) = -\infty - \frac{c\omega'}{2}$
- 18.12.24  $\sigma(\omega_2/2) = 0$
- Subcase II
- 18.12.25  $g_2 > 0, g_3 > 0: (e_1 = 2c, e_2 = e_3 = -c)$
- 18.12.26  $H_1 = 3c, H_2 = H_3 = 0$
- 18.12.27  $\mathcal{P}(z; 12c^2, 8c^3) = -c + 3c \{ \sin [(3c)^{1/3} z] \}^{-2}$
- 18.12.28  $\zeta(z; 12c^2, 8c^3) = cz + (3c)^{1/3} \cot [(3c)^{1/3} z]$
- 18.12.29  $\sigma(z; 12c^2, 8c^3) = (3c)^{-1/3} \sin [(3c)^{1/3} z] e^{cz^2/2}$
- 18.12.30  $\omega = (12c)^{-1/3} \pi, \omega' = i\infty$
- 18.12.31  $\eta = \zeta(\omega) = c\omega$
- 18.12.32  $\eta' = \zeta(\omega') = i\infty$
- 18.12.33  $q = 0, m = 0$
- 18.12.34  $\sigma(\omega) = \frac{2\omega e^{\pi^2/24}}{\pi}$
- 18.12.35  $\sigma(\omega') = 0$
- 18.12.36  $\sigma(\omega_2) = 0$
- 18.12.37  $\mathcal{P}(\omega/2) = 5c$
- 18.12.38  $\mathcal{P}'(\omega/2) = \frac{-\pi^3}{2\omega^3}$
- 18.12.39  $\zeta(\omega/2) = \frac{1}{2}(c\omega + \pi/\omega)$
- 18.12.40  $\sigma(\omega/2) = \frac{e^{\pi^2/96} \omega \sqrt{2}}{\pi}$
- 18.12.41  $\mathcal{P}(\omega'/2) = -c$
- 18.12.42  $\mathcal{P}'(\omega'/2) = 0$
- 18.12.43  $\zeta(\omega'/2) = +i\infty$
- 18.12.44  $\sigma(\omega'/2) = 0$
- 18.12.45  $\mathcal{P}(\omega_2/2) = -c$

- 18.12.46  $\mathcal{P}'(\omega_2/2) = 0$
- 18.12.47  $\zeta(\omega_2/2) = \frac{c\omega}{2} + i\infty$
- 18.12.48  $\sigma(\omega_2/2) = 0$
- Subcase III
- 18.12.49  $g_2 = 0, g_3 = 0 (e_1 = e_2 = e_3 = 0)$
- 18.12.50  $\mathcal{P}(z; 0, 0) = z^{-2}$
- 18.12.51  $\zeta(z; 0, 0) = z^{-1}$
- 18.12.52  $\sigma(z; 0, 0) = z$
- 18.12.53  $\omega = -i\omega' = \infty$

**18.13. Equianharmonic Case ( $g_2 = 0, g_3 = 1$ )**

If  $g_2 = 0$  and  $g_3 > 0$ , homogeneity relations allow us to reduce our considerations of  $\mathcal{P}$  to  $\mathcal{P}(z; 0, 1)$  ( $\mathcal{P}', \zeta$  and  $\sigma$  are handled similarly). Thus  $\mathcal{P}(z; 0, g_3) = g_3^{1/3} \mathcal{P}(zg_3^{1/3}; 0, 1)$ . The case  $g_2 = 0, g_3 = 1$  is called the EQUIANHARMONIC case.

$\frac{1}{2}$  FPP; Reduction to Fundamental Triangle

$\Delta_1 \equiv \Delta_0 \omega_2 z_0$  is the Fundamental Triangle

Let  $\epsilon$  denote  $e^{2\pi/3}$  throughout 18.13.

$\omega_2 \approx 1.5299 \ 54037 \ 05719 \ 28749 \ 13194 \ 17231^6$

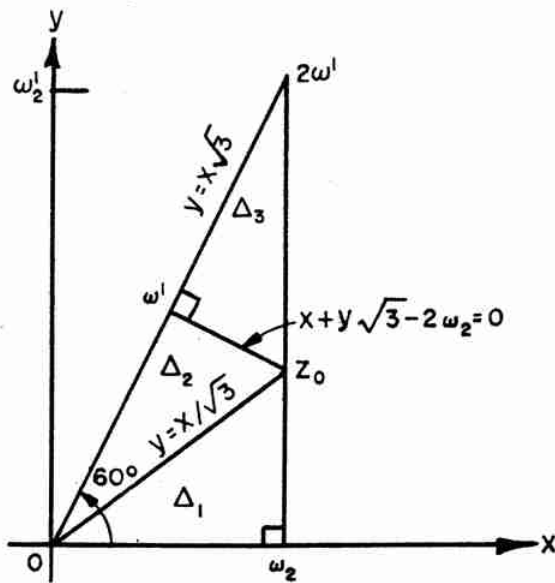

FIGURE 18.11

<sup>6</sup> This value was computed and checked by multiple precision on a desk calculator and is believed correct to 30S.

Reduction for  $z_2$  in  $\Delta_2$ :  $z_1 = \epsilon \bar{z}_2$  is in  $\Delta_1$ .

18.13.1  $\mathcal{P}(z_2) = \epsilon^{-2} \bar{\mathcal{P}}(z_1)$

18.13.2  $\mathcal{P}'(z_2) = -\bar{\mathcal{P}}'(z_1)$

18.13.3  $\zeta(z_2) = \epsilon^{-1} \bar{\zeta}(z_1)$

18.13.4  $\sigma(z_2) = \epsilon \bar{\sigma}(z_1)$

Reduction for  $z_3$  in  $\Delta_3$ :  $z_1 = \epsilon^{-1}(2\omega' - z_3)$  is in  $\Delta_1$

18.13.5  $\mathcal{P}(z_3) = \epsilon^{-2} \mathcal{P}(z_1)$

18.13.6  $\mathcal{P}'(z_3) = \mathcal{P}'(z_1)$

18.13.7  $\zeta(z_3) = -\epsilon^{-1} \zeta(z_1) + 2\eta'$ ,  $\eta' = \zeta(\omega')$

18.13.8  $\sigma(z_3) = \epsilon \sigma(z_1) \exp [(z_3 - \omega')(2\eta')]$

Special Values and Formulas

18.13.9

$\Delta = -27$ ,  $H_1 = \sqrt{3}(4^{-1/3})\bar{\epsilon}$ ,

$H_2 = \sqrt{3}(4^{-1/3})$ ,  $H_3 = \sqrt{3}(4^{-1/3})\epsilon$

18.13.10  $m = \sin^2 15^\circ = \frac{2 - \sqrt{3}}{4}$ ,  $q = ie^{-\pi\sqrt{3}/2}$

18.13.11  $\vartheta_2(0) = Ae^{i\pi/8}$

18.13.12  $\vartheta_3(0) = Ae^{i\pi/24}$

18.13.13  $\vartheta_4(0) = Ae^{-i\pi/24}$

18.13.14

where  $A = (\omega_2/\pi)^{1/2} 2^{1/3} 3^{1/8} \approx 1.0086 67$

18.13.15  $\omega_2 = \frac{K(m)2^{1/3}}{3^{1/4}} = \frac{\Gamma^3(1/3)}{4\pi}$

Values at Half-periods

|                                       | $\mathcal{P}$                 | $\mathcal{P}'$ | $\zeta$   | $\sigma$                                       |
|---------------------------------------|-------------------------------|----------------|---|--|
| 18.13.16<br>$\omega \equiv \omega_1$  | $e_1 = 4^{-1/3}\epsilon^2$    | 0              | $\eta = \epsilon\pi/2\omega_2\sqrt{3}$          | $\epsilon^{-1}\sigma(\omega_2)$                |
| 18.13.17<br>$\omega_2$                | $e_2 = 4^{-1/3}$              | 0              | $\eta_2 = \eta + \eta' = \pi/2\omega_2\sqrt{3}$ | $\frac{e^{\pi/4\sqrt{3}}(2^{1/3})}{3^{1/2}}$   |
| 18.13.18<br>$\omega' \equiv \omega_3$ | $e_3 = 4^{-1/3}\epsilon^{-2}$ | 0              | $\eta' = \epsilon^{-1}\pi/2\omega_2\sqrt{3}$    | $\epsilon\sigma(\omega_2)$                     |
| 18.13.19<br>$\omega_2'$               | $e_2 = 4^{-1/3}$              | 0              | $\eta_2' = -\pi i/2\omega_2 = \eta' - \eta$     | $\frac{ie^{3\pi/4\sqrt{3}}(2^{1/3})}{3^{1/2}}$ |

Values <sup>7</sup> along  $(0, \omega_2)$

|                           | $\mathcal{P}$   | $\mathcal{P}'$   | $\zeta$  | $\sigma$   |
|---------------------------|---|--|--|--|
| 18.13.20<br>$2\omega_2/9$ | $\frac{\sqrt[3]{\cos 80^\circ}}{\sqrt[3]{\cos 20^\circ} - \sqrt[3]{\cos 40^\circ}}$ | $-\frac{\sqrt{3}[\sqrt[3]{\cos 20^\circ} + \sqrt[3]{\cos 40^\circ}]}{\sqrt[3]{\cos 20^\circ} - \sqrt[3]{\cos 40^\circ}}$ |  |  |
| 18.13.21<br>$\omega_2/3$  | $1/(2^{1/3} - 1)$   | $-\sqrt{3}(2^{1/3} + 1)/(2^{1/3} - 1)$   | $\frac{\eta_2}{3} + \frac{\sqrt{3}(2^{2/3} + 2 + 2^{4/3})}{6}$   | $\frac{e^{\pi/36\sqrt{3}}}{3^{1/6}} \sqrt[4]{\frac{2^{1/3} - 1}{2^{1/3} + 1}}$ |
| 18.13.22<br>$4\omega_2/9$ | $\frac{\sqrt[3]{\cos 40^\circ}}{\sqrt[3]{\cos 20^\circ} - \sqrt[3]{\cos 80^\circ}}$ | $-\frac{\sqrt{3}[\sqrt[3]{\cos 20^\circ} + \sqrt[3]{\cos 80^\circ}]}{\sqrt[3]{\cos 20^\circ} - \sqrt[3]{\cos 80^\circ}}$ |  |  |
| 18.13.23<br>$\omega_2/2$  | $e_2 + H_2$   | $-3^{3/4}\sqrt{2 + \sqrt{3}}$  | $(\pi/4\omega_2\sqrt{3}) + (3^{1/4}\sqrt{2 + \sqrt{3}}/2^{4/3})$ | $\frac{e^{\pi/16\sqrt{3}}(2^{1/12})}{3^{1/4}\sqrt{2 + \sqrt{3}}}$              |
| 18.13.24<br>$2\omega_2/3$ | 1   | $-\sqrt{3}$  | $\frac{2}{3}(\eta_2) + 3^{-1/2}$                                 | $e^{\pi/18\sqrt{3}}/3^{1/6}$   |
| 18.13.25<br>$8\omega_2/9$ | $\frac{\sqrt[3]{\cos 20^\circ}}{\sqrt[3]{\cos 40^\circ} + \sqrt[3]{\cos 80^\circ}}$ | $-\frac{\sqrt{3}[\sqrt[3]{\cos 40^\circ} - \sqrt[3]{\cos 80^\circ}]}{\sqrt[3]{\cos 40^\circ} + \sqrt[3]{\cos 80^\circ}}$ |  |  |

<sup>7</sup> Values at  $2\omega_2/9$ ,  $4\omega_2/9$  and  $8\omega_2/9$  from [18.14].

Values along (0, z<sub>0</sub>)

|                      | $\mathcal{P}$    | $\mathcal{P}'$                | $\zeta$   | $\sigma$   |
|----------------------|------------------|-------------------------------|---|--|
| 18.13.26<br>$z_0/2$  | $-2^{1/3}e^3$    | $3i$                          | $\left[\frac{\eta_2}{\sqrt{3}} + 2^{-1/3}\right] e^{-ix/6}$                               | $\frac{e^{\pi/12} \sqrt{3} e^{ix/6}}{3^{1/4}}$                               |
| 18.13.27<br>$3z_0/4$ | $e^3(e_2 - H_2)$ | $i(3^{3/4})\sqrt{2-\sqrt{3}}$ | $\left[\frac{\pi}{4\omega_2} + \frac{3^{1/4}\sqrt{2-\sqrt{3}}}{2^{1/3}}\right] e^{-ix/6}$ | $\frac{e^{3\pi/16} \sqrt{3} (2^{1/12}) e^{ix/6}}{3^{1/4} \sqrt{2-\sqrt{3}}}$ |
| 18.13.28<br>$z_0$    | $0$              | $i$                           | $\frac{2\eta_2}{\sqrt{3}} e^{-ix/6}$  | $e^{\pi/3} \sqrt{3} e^{ix/6}$  |

Duplication Formulas

- 18.13.29  $\mathcal{P}(2z) = \frac{\mathcal{P}(z)[\mathcal{P}^3(z)+2]}{4\mathcal{P}^3(z)-1}$
- 18.13.30  $\mathcal{P}'(2z) = \frac{2\mathcal{P}^6(z)-10\mathcal{P}^3(z)-1}{[\mathcal{P}'(z)]^3}$
- 18.13.31  $\zeta(2z) = 2\zeta(z) + \frac{3\mathcal{P}^2(z)}{\mathcal{P}'(z)}$
- 18.13.32  $\sigma(2z) = -\mathcal{P}'(z)\sigma^4(z)$

Trisection Formulas (z real)

- 18.13.33  $\mathcal{P}\left(\frac{x}{3}\right) = \frac{\sqrt[3]{\cos \frac{\phi-\pi}{3}}}{\sqrt[3]{\cos \frac{\phi}{3}} - \sqrt[3]{\cos \frac{\phi+\pi}{3}}}$
- 18.13.34  $\mathcal{P}'\left(\frac{x}{3}\right) = -\sqrt{3} \frac{\sqrt[3]{\cos \frac{\phi}{3}} + \sqrt[3]{\cos \frac{\phi+\pi}{3}}}{\sqrt[3]{\cos \frac{\phi}{3}} - \sqrt[3]{\cos \frac{\phi+\pi}{3}}}$

where  $\tan \phi = \mathcal{P}'(x)$ ,  $0 < x < 2\omega_2$  and we must choose  $\phi$  in intervals

$$\left(-\frac{\pi}{2}, \frac{\pi}{2}\right), \left(\frac{\pi}{2}, \frac{3\pi}{2}\right), \left(\frac{3\pi}{2}, \frac{5\pi}{2}\right) \text{ to get}$$

$$\mathcal{P}\left(\frac{x}{3}\right), \mathcal{P}\left(\frac{x}{3} + \frac{2\omega_2}{3}\right), \mathcal{P}\left(\frac{x}{3} + \frac{4\omega_2}{3}\right), \text{ respectively.}$$

Complex Multiplication

- 18.13.35  $\mathcal{P}(\epsilon z) = \epsilon^{-2} \mathcal{P}(z)$
- 18.13.36  $\mathcal{P}'(\epsilon z) = -\mathcal{P}'(z)$
- 18.13.37  $\zeta(\epsilon z) = \epsilon^{-1} \zeta(z)$
- 18.13.38  $\sigma(\epsilon z) = \epsilon \sigma(z)$

In the above,  $\epsilon$  denotes (as it does throughout section 18.13),  $e^{i\pi/3}$ . The above equations are useful as follows, e.g.:

If  $z$  is real,  $\epsilon z$  is on  $0\omega'$  (Figure 18.11); if  $\epsilon z$  were purely imaginary,  $z$  would be on  $0z_0$  (Figure 18.11).

Conformal Maps

Equianharmonic Case

Map:  $f(z) = u + iv$

$\mathcal{P}(z)$

Near zero:  $\mathcal{P}(z) = \frac{1}{z^2} + \epsilon_1$

$\mathcal{P}(z) = \frac{1}{z^2} + \frac{z^4}{28} + \epsilon_2$

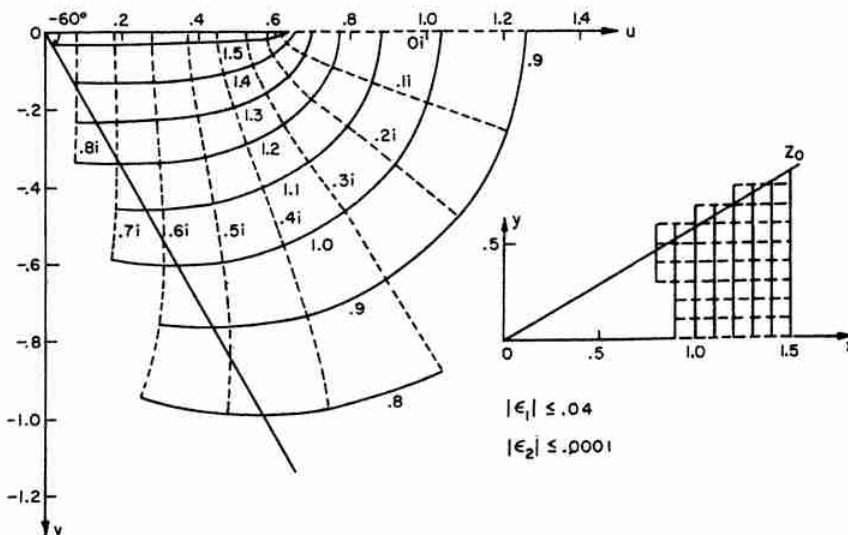

$\wp'(z)$

Near zero:  $\wp'(z) = \frac{-2}{z^3} + \epsilon_1$

$\wp'(z) = \frac{-2}{z^3} + \frac{z^3}{7} + \epsilon_2$

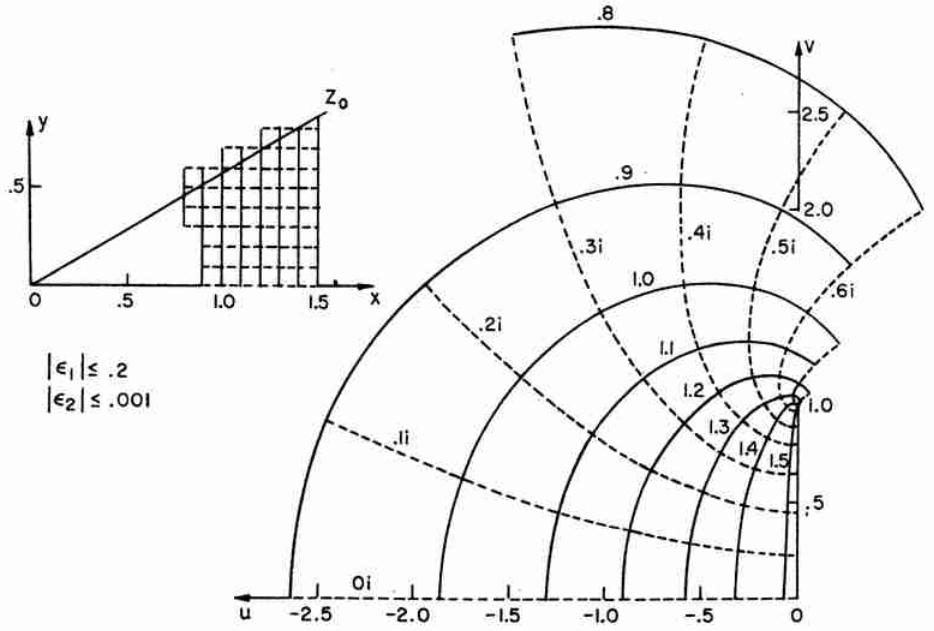

$\zeta(z)$

Near zero:  $\zeta(z) = \frac{1}{z} + \epsilon_1$

$\zeta(z) = \frac{1}{z} - \frac{z^5}{140} + \epsilon_2$

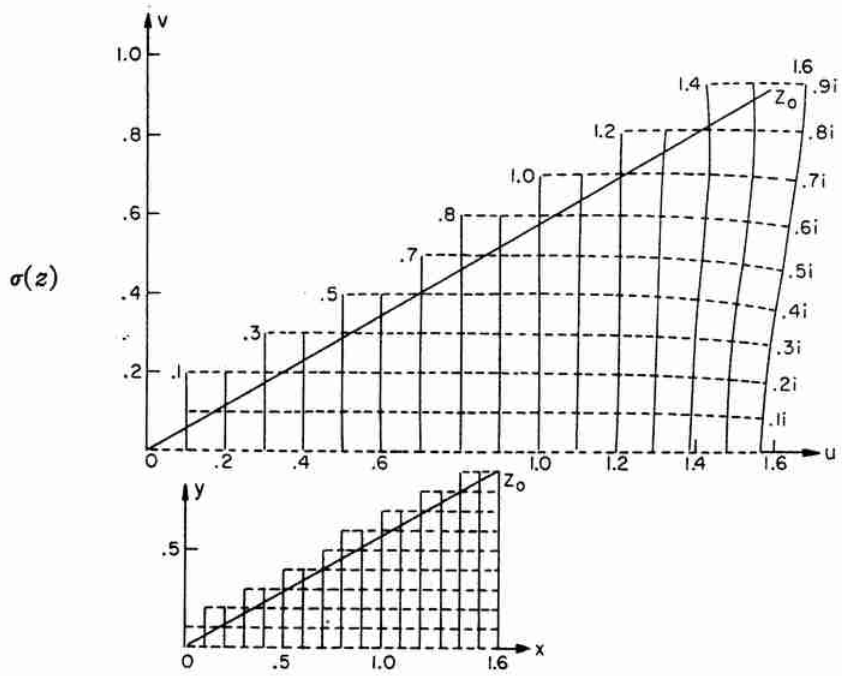
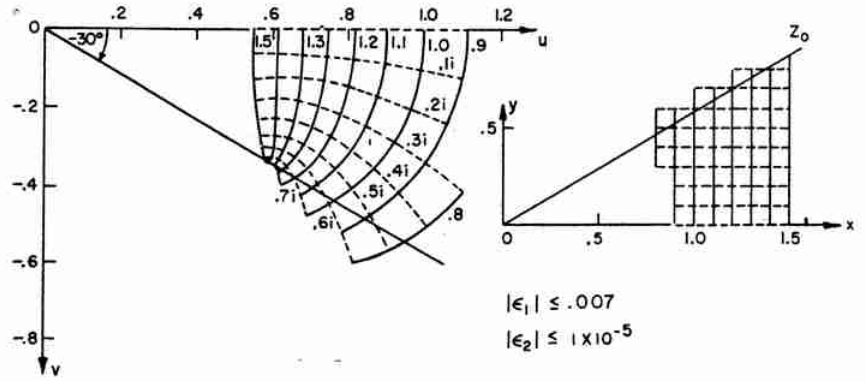

FIGURE 18.12

Coefficients for Laurent Series for  $\mathcal{P}$ ,  $\mathcal{P}'$  and  $\zeta$

( $c_m = 0$  for  $m \neq 3k$ )

| $k$ | EXACT $c_{3k}$   | APPROXIMATE $c_{3k}$                              |
|-----|--|---|
| 1   | 1/28   | 3. 5714 28571 42857 ... $\times 10^{-2}$          |
| 2   | 1/(13·28 <sup>2</sup> ) = 1/10192  | 9. 8116 16954 47409 73312 40188 $\times 10^{-5}$  |
| 3   | 1/(13·19·28 <sup>3</sup> ) = 1/5422144   | 1. 8442 88901 21693 55885 78983 $\times 10^{-7}$  |
| 4   | 3/(5·13 <sup>2</sup> ·19·28 <sup>4</sup> ) = 234375/(7709611 $\times 10^8$ )                                     | 3. 0400 36650 35758 61350 20301 $\times 10^{-10}$ |
| 5   | 4/(5·13 <sup>2</sup> ·19·31·28 <sup>5</sup> ) = 78125/(16729 85587 $\times 10^8$ )                               | 4. 6697 95161 83961 00384 33643 $\times 10^{-13}$ |
| 6   | (7·43)/(13 <sup>3</sup> ·19 <sup>2</sup> ·31·37·28 <sup>6</sup> )  | 6. 8662 18676 79393 36788 98 $\times 10^{-16}$    |
| 7   | (6·431)/(5·13 <sup>3</sup> ·19 <sup>2</sup> ·31·37·43·28 <sup>7</sup> )  | 9. 7990 31742 57961 41839 66 $\times 10^{-19}$    |
| 8   | (3·7·313)/(5 <sup>2</sup> ·13 <sup>4</sup> ·19 <sup>2</sup> ·31·37·43·28 <sup>8</sup> )                          | 1. 3685 06574 79360 13026 87 $\times 10^{-21}$    |
| 9   | (4·1201)/(5 <sup>2</sup> ·13 <sup>4</sup> ·19 <sup>2</sup> ·31·37·43·28 <sup>9</sup> )                           | 1. 8800 72610 01329 79236 40 $\times 10^{-24}$    |
| 10  | (2 <sup>2</sup> ·3·41·1823)/(5·13 <sup>5</sup> ·19 <sup>2</sup> ·31 <sup>2</sup> ·37·43·61·28 <sup>10</sup> )    | 2. 5497 66946 68202 63683 $\times 10^{-27}$       |
| 11  | (3·79·733)/(5·13 <sup>5</sup> ·19 <sup>2</sup> ·31 <sup>2</sup> ·37·43·61·67·28 <sup>11</sup> )                  | 3. 4222 48599 51463 05316 $\times 10^{-30}$       |
| 12  | 3·1153·13963·29059   | 4. 5541 38864 99184 30391 $\times 10^{-33}$       |
|     | 5 <sup>2</sup> ·13 <sup>6</sup> ·19 <sup>4</sup> ·31 <sup>2</sup> ·37 <sup>2</sup> ·43·61·67·73·28 <sup>12</sup> |   |
| 13  | 2 <sup>2</sup> ·3 <sup>2</sup> ·7·11·2647111   | 6. 0171 15776 98241 99591 $\times 10^{-36}$       |
|     | 5 <sup>2</sup> ·13 <sup>6</sup> ·19 <sup>4</sup> ·31 <sup>2</sup> ·37 <sup>2</sup> ·61·67·73·79·28 <sup>13</sup> |   |

First 5 approximate values determined from exact values of  $c_{3k}$ ; subsequent values determined by using exact ratios  $c_{3k}/c_{3k-3}$ , using at least double precision arithmetic with a desk calculator. All approximate  $c$ 's were checked with the use of the recursion relation;  $c_3 - c_{27}$  are believed correct to at least 21S;  $c_{30} - c_{39}$  are believed correct to 20S.

$$c_{3k} \leq \frac{c_3}{13^{k-1} \cdot 28^{k-1}}, \quad k=2, 3, 4, \dots$$

Other Series Involving  $\mathcal{P}$

Reversed Series for Large  $|\mathcal{P}|$

18.13.39

$$z = (\mathcal{P}^{-1})^{1/2} \left[ 1 + \frac{u}{7} + \frac{3u^2}{26} + \frac{5u^3}{38} + \frac{7u^4}{40} + \frac{63u^5}{248} + \frac{231u^6}{592} + \frac{429u^7}{688} + O(u^8) \right],$$

18.13.40 where  $u = \mathcal{P}^{-3}/8$  and  $z$  is in the Fundamental Triangle (Figure 18.11) if  $\mathcal{P}$  has an appropriate value.

Series near  $\omega_0$

18.13.41

$$\mathcal{P} = iu \left[ 1 - \frac{u^6}{7} + \frac{3u^{12}}{364} \right] + u^4 \left[ -\frac{1}{2} + \frac{u^6}{28} \right] + O(u^{10})$$

18.13.42

$$u = -i\mathcal{P} \left[ 1 + \frac{\mathcal{P}^3}{2} + \frac{6\mathcal{P}^6}{7} + 2\mathcal{P}^9 + \frac{70\mathcal{P}^{12}}{13} + O(\mathcal{P}^{15}) \right],$$

18.13.43 where  $u = (z - z_0)$

Series near  $\omega_2$

18.13.44

$$(\mathcal{P} - e_2) = 3e_2^2 u \left[ 1 + x + x^2 + \frac{6}{7}x^3 + \frac{5}{7}x^4 + \frac{4}{7}x^5 + \frac{285}{637}x^6 + O(x^7) \right],$$

18.13.45 where  $u = (z - \omega_2)^2$ ,  $x = e_2 u$

18.13.46

$$u = e_2^{-1} \left[ w - w^2 + w^3 - \frac{6}{7}w^4 + \frac{3}{7}w^5 + \frac{3}{7}w^6 - \frac{1143}{637}w^7 + O(w^8) \right],$$

18.13.47 where  $w = (\mathcal{P} - e_2)/3e_2$

Other Series Involving  $\mathcal{P}'$

Reversed Series for Large  $|\mathcal{P}'|$

18.13.48

$$z = 2^{1/3} (\mathcal{P}'^{1/3})^{-1} e^{4\pi/3} \left[ 1 - \frac{2}{21} (\mathcal{P}')^{-2} + \frac{5}{117} (\mathcal{P}')^{-4} + O(\mathcal{P}'^{-6}) \right],$$

$z$  being in the Fundamental Triangle (Figure 18.11) if  $\mathcal{P}'$  has an appropriate value.

Series near  $\omega_0$

18.13.49

$$(\mathcal{P}' - i) = x \left[ -2 - ix + \frac{5}{14}x^2 + \frac{3i}{28}x^3 + O(x^4) \right]$$

18.13.50 where  $x = (z - z_0)^3$

18.13.51  $x = 2\alpha \left[ 1 - i\alpha - \frac{9}{7}\alpha^2 + \frac{13i\alpha^3}{7} + O(\alpha^4) \right],$

18.13.52 where  $\alpha = (\mathcal{P}' - i)/(-4)$

Series near  $\omega_2$ 

18.13.53

$$\mathcal{P}' = 6e_2^3(z - \omega_2) \left[ 1 + 2v + 3v^2 + \frac{24}{7}v^3 + \frac{25}{7}v^4 + \frac{24}{7}v^5 + \frac{285}{91}v^6 + O(v^7) \right],$$

18.13.54 where  $v = e_2(z - \omega_2)^2$ 

18.13.55

$$(z - \omega_2) = (\mathcal{P}'/6e_2^3) \left[ 1 - 2w + 9w^2 - \frac{360}{7}w^3 + 330w^4 - 2268w^5 + \frac{212058}{13}w^6 + O(w^7) \right],$$

18.13.56 where  $w = \mathcal{P}'^2/9$ Other Series Involving  $\zeta$ Reversed Series for Large  $|\zeta|$ 

18.13.57

$$z = \zeta^{-1} \left[ 1 - \frac{\gamma}{7} + \frac{17\gamma^2}{143} - \frac{496\gamma^3}{3553} + O(\gamma^4) \right],$$

18.13.58

$$\gamma = \zeta^{-6}/20$$

Series near  $z_0$ 

18.13.59

$$(\zeta - \zeta_0) = i \left[ -\frac{u^2}{2} + \frac{u^8}{56} - \frac{3u^{14}}{5096} \right] + \left[ \frac{u^5}{8} - \frac{u^{11}}{308} \right] + O(u^{17}),$$

18.13.60 where  $u = (z - z_0)$ Series near  $\omega_2$ 

18.13.61

$$(\zeta - \eta_2) = -e_2(z - \omega_2) \left[ 1 + v + \frac{3}{5}v^2 + \frac{3}{7}v^3 + \frac{2}{7}v^4 + \frac{15}{77}v^5 + \frac{12}{91}v^6 + \frac{57}{637}v^7 + O(v^8) \right],$$

18.13.62

$$v = e_2(z - \omega_2)^2$$

18.13.63

$$(z - \omega_2) = \frac{(\zeta - \eta_2)}{-e_2} \left[ 1 - w + \frac{12w^2}{5} - \frac{267w^3}{35} + \frac{139w^4}{5} - \frac{30192w^5}{275} + \frac{1634208}{3575}w^6 + O(w^7) \right],$$

18.13.64

$$w = (\zeta - \eta_2)^2/e_2$$

Series Involving  $\sigma$ 

18.13.65

$$\sigma = z - \frac{2 \cdot 3}{7!} z^7 - \frac{2^3 \cdot 3^3}{13!} z^{13} + \frac{2^6 \cdot 3^4 \cdot 23}{19!} z^{19}$$

$$+ \frac{2^7 \cdot 3^5 \cdot 5^2 \cdot 31}{25!} z^{25} + \frac{2^8 \cdot 3^8 \cdot 5 \cdot 9103}{31!} z^{31}$$

$$- \frac{2^{12} \cdot 3^9 \cdot 5 \cdot 229 \cdot 2683}{37!} z^{37}$$

$$- \frac{2^{14} \cdot 3^{10} \cdot 5 \cdot 23 \cdot 257 \cdot 18049}{43!} z^{43}$$

$$- \frac{2^{15} \cdot 3^{12} \cdot 5 \cdot 59 \cdot 107895773}{49!} z^{49} + O(z^{55})$$

18.13.66

$$z = \sigma + \frac{\sigma^7}{2^8 \cdot 3 \cdot 5 \cdot 7} + \frac{41\sigma^{13}}{2^7 \cdot 3^2 \cdot 5^2 \cdot 11 \cdot 13} + \frac{13 \cdot 337\sigma^{19}}{2^{10} \cdot 3^4 \cdot 5^3 \cdot 11 \cdot 17 \cdot 19} + \frac{31 \cdot 101\sigma^{25}}{2^{15} \cdot 3^5 \cdot 5 \cdot 11^2 \cdot 17 \cdot 23} + O(\sigma^{31})$$

Economized Polynomials ( $0 \leq x \leq 1.53$ )

$$18.13.67 \quad x^2 \mathcal{P}(x) = \sum_0^6 a_n x^{6n} + \epsilon(x)$$

$$|\epsilon(x)| < 2 \times 10^{-7}$$

$$a_0 = (-1)9.99999 \quad 96 \quad a_4 = -(-9)2.20892 \quad 47$$

$$a_1 = (-2)3.57143 \quad 20 \quad a_5 = (-10)1.74915 \quad 35$$

$$a_2 = (-5)9.80689 \quad 93 \quad a_6 = -(-12)4.46863 \quad 93$$

$$a_3 = (-7)2.00835 \quad 02$$

$$18.13.68 \quad x^3 \mathcal{P}'(x) = \sum_0^6 a_n x^{6n} + \epsilon(x)$$

$$|\epsilon(x)| < 4 \times 10^{-7}$$

$$a_0 = -2.00000 \quad 00 \quad a_4 = -(-9)2.12719 \quad 66$$

$$a_1 = (-1)1.42857 \quad 22 \quad a_5 = (-10)6.53654 \quad 67$$

$$a_2 = (-4)9.81018 \quad 03 \quad a_6 = -(-11)1.70510 \quad 78$$

$$a_3 = (-6)3.00511 \quad 93$$

$$18.13.69 \quad x \zeta(x) = \sum_0^6 a_n x^{6n} + \epsilon(x)$$

$$|\epsilon(x)| < 3 \times 10^{-8}$$

$$a_0 = (-1)9.99999 \quad 98 \quad a_4 = (-10)6.12486 \quad 14$$

$$a_1 = -(-3)7.14285 \quad 86 \quad a_5 = (-11)4.66919 \quad 85$$

$$a_2 = -(-6)8.91165 \quad 65 \quad a_6 = (-12)1.25014 \quad 65$$

$$a_3 = -(-8)1.44381 \quad 84$$

18.14. Lemniscatic Case

$$(g_2=1, g_3=0)$$

If  $g_2 > 0$  and  $g_3 = 0$ , homogeneity relations allow us to reduce our consideration of  $\mathcal{P}$  to  $\mathcal{P}(z; 1, 0)$  ( $\mathcal{P}'$ ,  $\zeta$  and  $\sigma$  are handled similarly). Thus  $\mathcal{P}(z; g_2, 0) = g_2^{\frac{1}{2}} \mathcal{P}(zg_2^{\frac{1}{2}}; 1, 0)$ . The case  $g_2=1, g_3=0$  is called the LEMNISCATIC case.

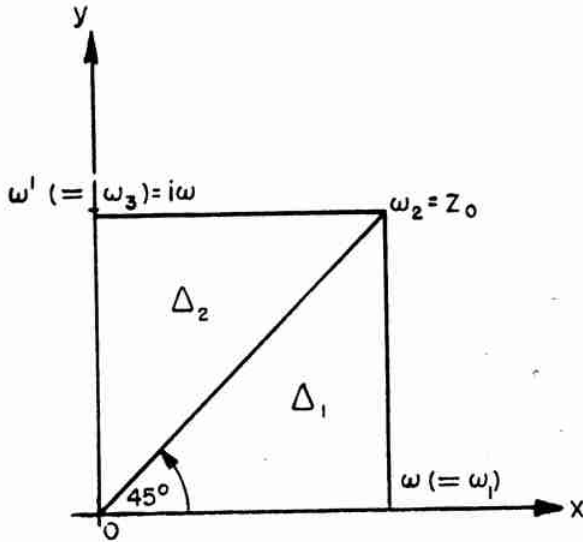

FIGURE 18.13

$\frac{1}{2}$ FPP; Reduction to Fundamental Triangle

$\Delta_1 \equiv \Delta 0\omega\omega_2$  is the Fundamental Triangle

$$\omega \approx 1.8540\ 74677\ 30137\ 192^8$$

Reduction for  $z_2$  in  $\Delta_2$ :  $z_1 = i\bar{z}_2$  is in  $\Delta_1$

18.14.1  $\mathcal{P}(z_2) = -\overline{\mathcal{P}}(z_1)$

18.14.2  $\mathcal{P}'(z_2) = i\overline{\mathcal{P}'}(z_1)$

18.14.3  $\zeta(z_2) = -i\overline{\zeta}(z_1)$

18.14.4  $\sigma(z_2) = i\overline{\sigma}(z_1)$

Special Values and Formulas

18.14.5

$$\Delta=1, H_1=H_3=2^{-\frac{1}{2}}, H_2=i/2,$$

$$m = \sin^2 45^\circ = \frac{1}{2}, q = e^{-\pi}$$

18.14.6  $\vartheta_2(0) = \vartheta_4(0) = (\omega\sqrt{2}/\pi)^{\frac{1}{2}}; \vartheta_3(0) = (2\omega/\pi)^{\frac{1}{2}}$

18.14.7  $\omega = K(\sin^2 45^\circ) = \frac{\Gamma^2(\frac{1}{4})}{4\sqrt{\pi}} = \frac{\tilde{\omega}}{\sqrt{2}}$  where

$\tilde{\omega} \approx 2.62205\ 75542\ 92119\ 81046\ 48395\ 89891\ 11941\ 36827\ 54951\ 43162$  is the Lemniscate constant [18.9]

<sup>8</sup> This value was computed and checked by double precision methods on a desk calculator and is believed correct to 18S.

Values at Half-periods

|                                  | $\mathcal{P}$        | $\mathcal{P}'$ | $\zeta$                  | $\sigma$                        |
|----------------------------------|----------------------|----------------|--------------------------|---------------------------------|
| 18.14.8<br>$\omega = \omega_1$   | $e_1 = \frac{1}{2}$  | 0              | $\eta = \pi/4\omega$     | $e^{\pi/8}(2^{1/4})$            |
| 18.14.9<br>$\omega_2 = z_0$      | $e_2 = 0$            | 0              | $\eta + \eta'$           | $e^{\pi/4}(\sqrt{2})e^{i\pi/4}$ |
| 18.14.10<br>$\omega' = \omega_3$ | $e_3 = -\frac{1}{2}$ | 0              | $\eta' = -\pi i/4\omega$ | $i e^{\pi/8}(2^{1/4})$          |

Values along  $(0, \omega)$

|                         | $\mathcal{P}$   | $\mathcal{P}'$                         | $\zeta$   | $\sigma$  |
|-------------------------|---|--|---|---|
| 18.14.11<br>$\omega/4$  | $\frac{\sqrt{\alpha}}{2}(\sqrt{\alpha} + 2^{1/4})(1 + 2^{1/4})$                 |  |   |   |
| 18.14.12<br>$\omega/2$  | $\alpha/2$  | $-\alpha$                              | $\frac{\pi}{8\omega} + \frac{\alpha}{2\sqrt{2}}$            | $\frac{e^{\pi/32}(2^{1/16})}{\alpha^{\frac{1}{2}}}$ |
| 18.14.13<br>$2\omega/3$ | $\frac{1}{2}\sqrt{1 + \sec 30^\circ}$   | $-\frac{\sqrt{2\sqrt{3}+3}}{\sqrt{3}}$ | $\frac{2\eta}{3} + \sqrt{\frac{\mathcal{P}(2\omega/3)}{3}}$ | $\frac{e^{\pi/18}(3^{1/8})}{(2 + \sqrt{3})^{1/18}}$ |
| 18.14.14<br>$3\omega/4$ | $\frac{\sqrt{\alpha}}{2}(\sqrt{\alpha} - 2^{\frac{1}{2}})(1 + 2^{\frac{1}{2}})$ |  |   |   |



Values along  $(0, z_0)$

|                      | $\mathcal{P}$                           | $\mathcal{P}'$                                      | $\zeta$  | $\sigma$  |
|----------------------|---|---|--|---|
| 18.14.15<br>$z_0/4$  | $-\frac{i}{2}(\alpha + \sqrt{2\alpha})$ | $\alpha(\sqrt{\alpha} + \sqrt{2})e^{i\pi/4}$        |  | $\frac{e^{\pi/64}(2^{1/32})}{\alpha^{1/4}(\sqrt{\alpha} + \sqrt{2})^{1/4}} e^{i\pi/4}$  |
| 18.14.16<br>$z_0/2$  | $-i/2$                                  | $e^{i\pi/4}$  | $\left[\frac{\pi}{4\omega\sqrt{2}} + \frac{1}{2}\right] e^{-i\pi/4}$   | $e^{\pi/16}(2^{1/8})e^{i\pi/4}$   |
| 18.14.17<br>$2z_0/3$ | $\frac{-i}{2} \sqrt{\sec 30^\circ - 1}$ | $\frac{e^{i\pi/4} \sqrt[4]{2\sqrt{3}-3}}{\sqrt{3}}$ | $\frac{2\eta_2}{3} + \left[\frac{\mathcal{P}(2z_0/3)}{3}\right]^{1/2}$ | $\frac{e^{\pi/6} e^{i\pi/4} (3^{1/6})}{\sqrt[12]{2\sqrt{3}-3}}$                         |
| 18.14.18<br>$3z_0/4$ | $-\frac{i}{2}(\alpha - \sqrt{2\alpha})$ | $\alpha(\sqrt{\alpha} - \sqrt{2})e^{i\pi/4}$        |  | $\frac{e^{9\pi/64}(2^{1/32})}{\alpha^{1/4}(\sqrt{\alpha} - \sqrt{2})^{1/4}} e^{i\pi/4}$ |

$\alpha = 1 + \sqrt{2}$

Duplication Formulas

18.14.19  $\mathcal{P}(2z) = [\mathcal{P}^2(z) + \frac{1}{4}] / \{ \mathcal{P}(z)[4\mathcal{P}^2(z) - 1] \}$

18.14.20

$\mathcal{P}'(2z) = (\beta + 1)(\beta^2 - 6\beta + 1) / [32\mathcal{P}'^3(z)]$ ,  $\beta = 4\mathcal{P}^2(z)$

18.14.21  $\zeta(2z) = 2\zeta(z) + \frac{6\mathcal{P}^2(z) - \frac{1}{2}}{2\mathcal{P}'(z)}$

18.14.22  $\sigma(2z) = -\mathcal{P}'(z)\sigma^4(z)$

Bisection Formulas ( $0 < x < 2\omega$ )

18.14.23

$\mathcal{P}\left(\frac{x}{2}\right) = [\mathcal{P}^{\frac{1}{2}}(x) + \{ \mathcal{P}(x) + \frac{1}{2} \}^{\frac{1}{2}}] [\mathcal{P}^{\frac{1}{2}}(x) \pm \{ \mathcal{P}(x) - \frac{1}{2} \}^{\frac{1}{2}}]$   
 [Use + on  $0 < x \leq \omega$ , - on  $\omega \leq x < 2\omega$ ]

18.14.24

$\frac{1}{2}\mathcal{P}'\left(\frac{x}{2}\right) = \mathcal{P}'(x) \mp [2\mathcal{P}(x) + \frac{1}{2}]\sqrt{\mathcal{P}(x) - \frac{1}{2}} - [2\mathcal{P}(x) - \frac{1}{2}]\sqrt{\mathcal{P}(x) + \frac{1}{2}} - 2\mathcal{P}^{3/2}(x)$  (See [18.13].)  
 [Use - on  $0 < x \leq \omega$ , + on  $\omega \leq x < 2\omega$ ]

Complex Multiplication

18.14.25  $\mathcal{P}(iz) = -\mathcal{P}(z)$

18.14.26  $\mathcal{P}'(iz) = i\mathcal{P}'(z)$

18.14.27  $\zeta(iz) = -i\zeta(z)$

18.14.28  $\sigma(iz) = i\sigma(z)$

The above equations could be used as follows, e.g.: If  $z$  were real,  $iz$  would be purely imaginary.

Conformal Maps

Lemniscatic Case

Map:  $f(z) = u + iv$   
 $\mathcal{P}(z)$

Near zero:  $\mathcal{P}(z) = \frac{1}{z^2} + \epsilon_1$

$\mathcal{P}(z) = \frac{1}{z^2} + \frac{z^2}{20} + \epsilon_2$ ,  $|z| < 1$

Near  $z_0$ :  $\mathcal{P}(z) = \frac{-(z-z_0)^2}{4} + \epsilon_3$ ,  $|z-z_0| < \sqrt{2}$

$\mathcal{P}(z) = \frac{-(z-z_0)^2}{4} + \frac{(z-z_0)^6}{80} + \epsilon_4$

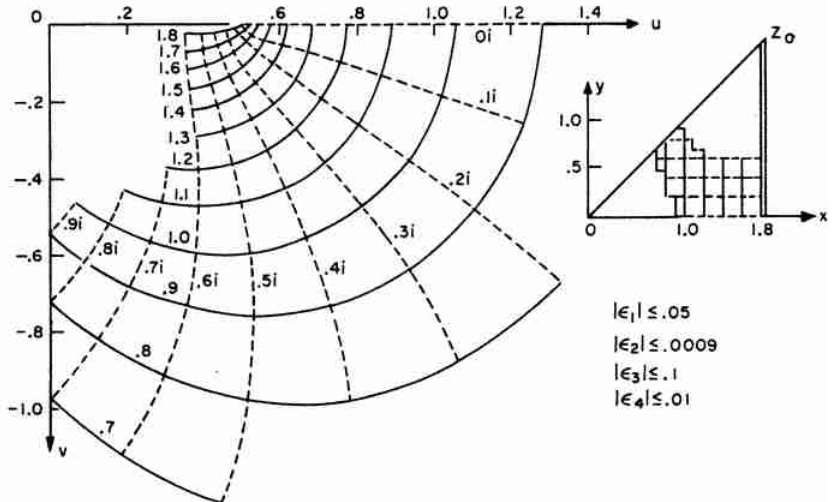

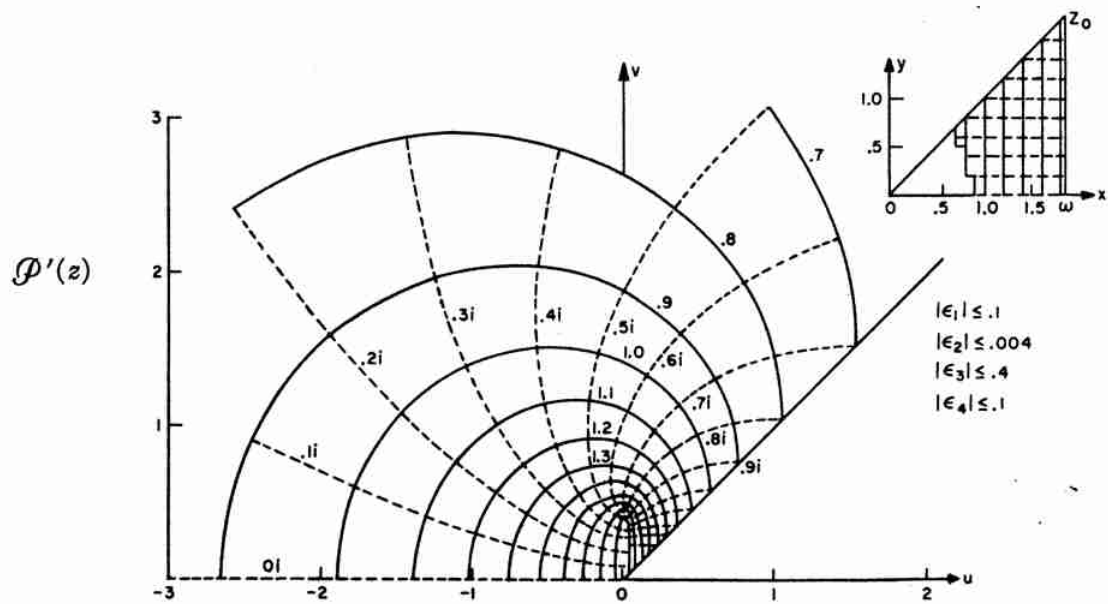

Near zero:  $\wp'(z) = \frac{-2}{z^3} + \epsilon_1$

Near  $z_0$ :  $\wp'(z) = \frac{-(z-z_0)}{2} + \epsilon_3$

$\wp'(z) = \frac{-2}{z^3} + \frac{z}{10} + \epsilon_2$

$\wp'(z) = \frac{-(z-z_0)}{2} + \frac{3(z-z_0)^5}{40} + \epsilon_4$

Near zero:  $\zeta(z) = \frac{1}{z} + \epsilon_1$

$\zeta(z) = \frac{1}{z} - \frac{z^3}{60} + \epsilon_2, |z| < 1$

Near  $z_0$ :  $\zeta(z) = \zeta_0 + \frac{(z-z_0)^3}{12} + \epsilon_3,$

$|z-z_0| < \sqrt{2}$

$\zeta(z) = \zeta_0 + \frac{(z-z_0)^3}{12} - \frac{(z-z_0)^7}{560} + \epsilon_4$

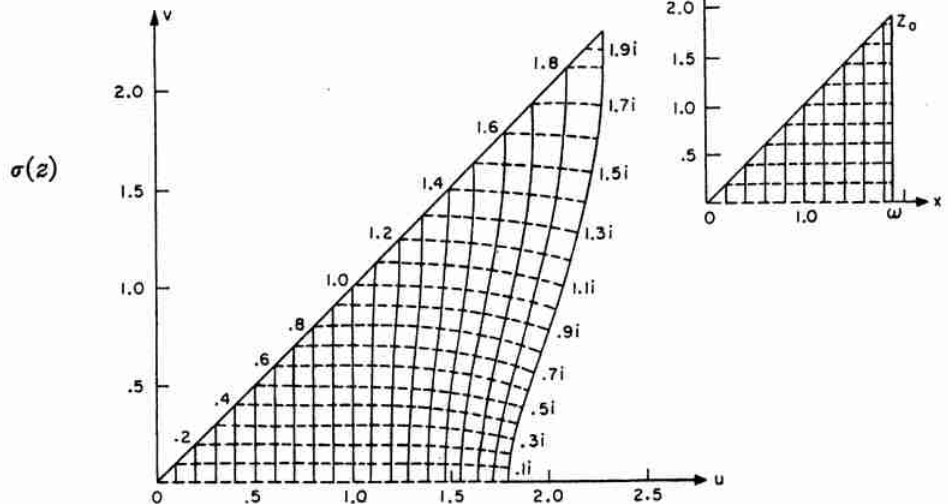
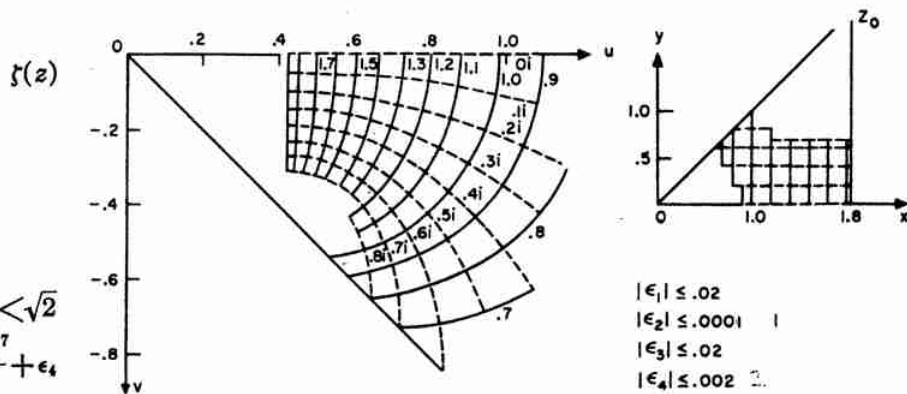

FIGURE 18.14

Coefficients for Laurent Series for  $\mathcal{P}$ ,  $\mathcal{P}'$ , and  $\zeta$

( $c_m=0$  for  $m$  odd)

| $k$ | EXACT $c_{2k}$  | APPROXIMATE $c_{2k}$                       |
|-----|---|--|
| 1   | 1/20  | .05  |
| 2   | 1/(3·20 <sup>2</sup> )=1/1200   | .8333 . . . ×10 <sup>-3</sup>              |
| 3   | 2/(3·13·20 <sup>3</sup> )=1/156000  | .641025 641025 . . . ×10 <sup>-5</sup>     |
| 4   | 5/(3·13·17·20 <sup>4</sup> )=1/21216000   | .47134 23831 07088 98944×10 <sup>-7</sup>  |
| 5   | 2/(3 <sup>2</sup> ·13·17·20 <sup>5</sup> )=1/(31824×10 <sup>5</sup> )   | .31422 82554 04725 99296×10 <sup>-9</sup>  |
| 6   | 10/(3 <sup>3</sup> ·13 <sup>2</sup> ·17·20 <sup>6</sup> )=1/(4964544×10 <sup>6</sup> )  | .20142 83688 49183 32882×10 <sup>-11</sup> |
| 7   | 4/(3·13 <sup>2</sup> ·17·29·20 <sup>7</sup> )=1/(7998432×10 <sup>7</sup> )  | .12502 45048 02941 37651×10 <sup>-13</sup> |
| 8   | 2453/(3 <sup>4</sup> ·11·13 <sup>2</sup> ·17 <sup>2</sup> ·29·20 <sup>8</sup> )=958203125/(1262002599×10 <sup>8</sup> )       | .75927 19109 76468 59917×10 <sup>-15</sup> |
| 9   | 2·5·7·61/(3 <sup>3</sup> ·13 <sup>3</sup> ·17 <sup>2</sup> ·29·37·20 <sup>9</sup> )=833984375/(18394643943×10 <sup>17</sup> ) | .45338 43533 93461 06092×10 <sup>-18</sup> |

$c_{2k} \leq \frac{c_2^k}{2^{k-1}}, k=1, 2, \dots$

Other Series Involving  $\mathcal{P}$

Reversed Series for Large  $|\mathcal{P}|$

18.14.29

$$z = (\mathcal{P}^{-1})^{1/2} \left[ 1 + \frac{w}{5} + \frac{w^2}{6} + \frac{5w^3}{26} + \frac{35w^4}{136} + \frac{3w^5}{8} + \frac{231w^6}{400} + \frac{429w^7}{464} + \frac{195w^8}{128} + \frac{12155w^9}{4736} + \frac{46189w^{10}}{10496} + O(w^{11}) \right],$$

18.14.30  $w = \mathcal{P}^{-2}/8$ , and  $z$  is in the Fundamental Triangle (Figure 18.13) if  $\mathcal{P}$  has an appropriate value.

Series near  $z_0$

18.14.31  $2\mathcal{P} = -x + \frac{x^3}{5} - \frac{2x^5}{75} + \frac{x^7}{325} + O(x^9)$ ,

18.14.32  $x = (z - z_0)^2/2$

18.14.33  $x = -\left[ w + \frac{w^3}{5} + \frac{7w^5}{75} + \frac{11w^7}{195} + O(w^9) \right]$   
 $w = 2\mathcal{P}$

Series near  $\omega$

18.14.34

$$(\mathcal{P} - e_1) = v + v^2 + \frac{4v^3}{5} + \frac{3v^4}{5} + \frac{32v^5}{75} + \frac{22v^6}{75} + \frac{64v^7}{325} + O(v^8)$$

18.14.35  $v = (z - \omega)^2/2$

18.14.36

$$v = y \left[ 1 - y + \frac{6y^2}{5} - \frac{8y^3}{5} + \frac{172y^4}{75} - \frac{52y^5}{15} + \frac{1064y^6}{195} + O(y^7) \right],$$

18.14.37  $y = (\mathcal{P} - e_1)$

Other Series Involving  $\mathcal{P}'$

Reversed Series for Large  $|\mathcal{P}'|$

18.14.38

$$z = Au \left[ 1 - \frac{v}{5} + \frac{5v^3}{39} - \frac{7v^4}{51} + O(v^5) \right], \quad u = (\mathcal{P}'^{1/3})^{-1} e^{i\pi/3},$$

18.14.39  $A = 2^{1/3}$ ,  $v = Au^4/6$ , and  $z$  is in the Fundamental Triangle (Figure 18.13) if  $\mathcal{P}'$  has an appropriate value.

Series near  $z_0$

18.14.40

$$\mathcal{P}' = \frac{1}{2} (z - z_0) \left[ -1 + 3w - \frac{10w^2}{3} + \frac{35w^3}{13} + O(w^4) \right],$$

18.14.41

$$w = (z - z_0)^4/20$$

18.14.42

$$(z - z_0) = 2\mathcal{P}' \left[ 1 + \frac{3u}{5} + \frac{5u^2}{3} + \frac{84u^3}{13} + O(u^4) \right],$$

18.14.43

$$u = 4\mathcal{P}'^4$$

Series near  $\omega$

18.14.44

$$\mathcal{P}' = x \left[ 1 + x^2 + \frac{3}{5}x^4 + \frac{3}{10}x^6 + \frac{2}{15}x^8 + \frac{11}{200}x^{10} + O(x^{12}) \right],$$

18.14.45

$$x = (z - \omega)$$

18.14.46

$$x = \mathcal{P}' - \mathcal{P}'^3 + \frac{12\mathcal{P}'^5}{5} - \frac{15\mathcal{P}'^7}{2} + \frac{80\mathcal{P}'^9}{3} - \frac{819\mathcal{P}'^{11}}{8} + O(\mathcal{P}'^{13})$$

Other Series Involving  $\zeta$

Reversed Series for Large  $|\zeta|$

18.14.47  $z = \zeta^{-1} \left[ 1 - \frac{v}{5} + \frac{v^2}{7} - \frac{136v^3}{1001} + \frac{1349v^4}{9163} + O(v^5) \right],$

18.14.48

$$v = \zeta^{-4}/12$$

Series near  $z_0$ 

18.14.49

$$(\zeta - \zeta_0) = \frac{1}{4}(z - z_0)^3 \left[ \frac{1}{3} - \frac{v}{7} + \frac{2v^2}{33} - \frac{v^3}{39} + O(v^4) \right],$$

18.14.50

$$v = (z - z_0)^4 / 20$$

Series near  $\omega$ 

18.14.51

$$(\zeta - \eta) = -\frac{x}{2} - \frac{x^3}{6} - \frac{x^5}{20} - \frac{x^7}{70} - \frac{x^9}{240} - \frac{x^{11}}{825} - \frac{11x^{13}}{31200} - \frac{x^{15}}{9750} + O(x^{17}),$$

18.14.52

$$x = (z - \omega)$$

18.14.53

$$x = w - \frac{w^3}{3} + \frac{7w^5}{30} - \frac{13w^7}{63} + \frac{929w^9}{4536} - \frac{194w^{11}}{891} + \frac{942883w^{13}}{3891888} + O(w^{15})$$

18.14.54  $w = -2(\zeta - \eta)$ Series Involving  $\sigma$ 

18.14.55

$$\sigma = z - \frac{z^5}{2 \cdot 5!} - \frac{3^2 z^9}{2^2 \cdot 9!} + \frac{3 \cdot 23 z^{13}}{2^3 \cdot 13!} + \frac{3 \cdot 107 z^{17}}{2^4 \cdot 17!} + \frac{3^3 \cdot 7 \cdot 23 \cdot 37 z^{21}}{2^5 \cdot 21!} + \frac{3^2 \cdot 313 \cdot 503 z^{25}}{2^6 \cdot 25!} - \frac{3^4 \cdot 7 \cdot 685973 z^{29}}{2^7 \cdot 29!} + O(z^{33})$$

18.14.56

$$z = \sigma + \frac{\sigma^5}{2^4 \cdot 3 \cdot 5} + \frac{\sigma^9}{2^9 \cdot 3 \cdot 7} + \frac{17 \cdot 113 \sigma^{13}}{2^{13} \cdot 3^4 \cdot 7 \cdot 11 \cdot 13} + \frac{122051 \sigma^{17}}{2^{19} \cdot 3^5 \cdot 7^2 \cdot 11 \cdot 17} + \frac{5 \cdot 13 \sigma^{21}}{2^{23} \cdot 3^2 \cdot 11 \cdot 19} + O(\sigma^{25})$$

Economized Polynomials ( $0 \leq x \leq 1.86$ )

$$18.14.57 \quad x^2 \mathcal{P}(x) = \sum_0^6 a_n x^{4n} + \epsilon(x)$$

$$|\epsilon(x)| < 2 \times 10^{-7}$$

$$\begin{aligned} a_0 &= (-1)9.99999 \ 98 & a_4 &= (-8)4.81438 \ 20 \\ a_1 &= (-2)4.99999 \ 62 & a_5 &= (-10)2.29729 \ 21 \\ a_2 &= (-4)8.33352 \ 77 & a_6 &= (-12)4.94511 \ 45 \\ a_3 &= (-6)6.40412 \ 86 \end{aligned}$$

$$18.14.58 \quad x^3 \mathcal{P}'(x) = \sum_0^6 a_n x^{4n} + \epsilon(x)$$

$$|\epsilon(x)| < 4 \times 10^{-7}$$

$$\begin{aligned} a_0 &= -2.00000 \ 00 & a_4 &= (-7)6.58947 \ 52 \\ a_1 &= (-1)1.00000 \ 02 & a_5 &= (-9)5.59262 \ 49 \\ a_2 &= (-3)4.99995 \ 38 & a_6 &= (-11)5.54177 \ 69 \\ a_3 &= (-5)6.41145 \ 59 \end{aligned}$$

$$18.14.59 \quad x \zeta'(x) = \sum_0^6 a_n x^{4n} + \epsilon(x)$$

$$|\epsilon(x)| < 3 \times 10^{-8}$$

$$\begin{aligned} a_0 &= (-1)9.99999 \ 99 & a_4 &= -(-9)2.57492 \ 62 \\ a_1 &= -(-2)1.66666 \ 74 & a_5 &= -(-11)5.67008 \ 00 \\ a_2 &= -(-4)1.19036 \ 70 & a_6 &= (-13)9.70015 \ 80 \\ a_3 &= -(-7)5.86451 \ 63 \end{aligned}$$

## 18.15. Pseudo-Lemniscatic Case

$$(g_2 = -1, g_3 = 0)$$

If  $g_2 < 0$  and  $g_3 = 0$ , homogeneity relations allow us to reduce our consideration of  $\mathcal{P}$  to  $\mathcal{P}(z; -1, 0)$ . Thus

$$18.15.1 \quad \mathcal{P}(z; g_2, 0) = |g_2|^{1/2} \mathcal{P}(z|g_2|^{1/4}; -1, 0)$$

[ $\mathcal{P}'$ ,  $\zeta$  and  $\sigma$  are handled similarly]. Because of its similarity to the lemniscatic case, we refer to the case  $g_2 = -1, g_3 = 0$  as the pseudo-lemniscatic case. It plays the same role (period ratio unity) for  $\Delta < 0$  as does the lemniscatic case for  $\Delta > 0$ .

$$\begin{aligned} \omega_2 &= \sqrt{2} \times (\text{real half-period for lemniscatic case}) \\ &= \tilde{\omega} \quad (\text{the Lemniscate Constant—see 18.14.7}) \end{aligned}$$

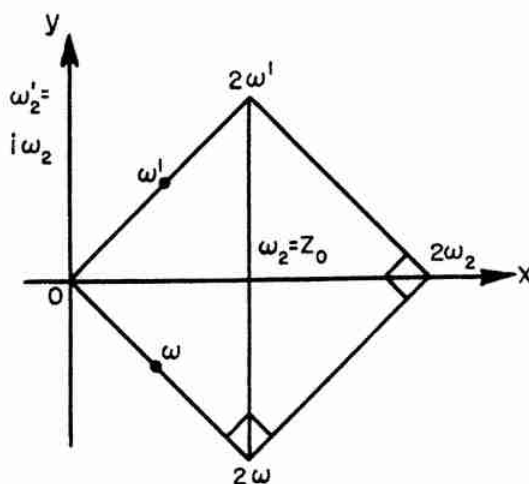

FIGURE 18.15

Special Values and Relations

- |   |  |   |
|---|--|---|
| <p>18.15.2 <math>\Delta = -1, g_2 = -1, g_3 = 0</math></p> <p>18.15.3 <math>H_1 = -i/\sqrt{2}, H_2 = \frac{1}{2}, H_3 = i/\sqrt{2}, m = \frac{1}{2}, q = ie^{-\pi/2}</math></p> |  | <p>18.15.4 <math>\vartheta_2(0) = R2^{1/4}e^{i\pi/8}, \vartheta_3(0) = Re^{i\pi/8}, \vartheta_4(0) = Re^{-i\pi/8},</math></p> <p>18.15.5 where <math>R = \sqrt{\omega_2\sqrt{2}/\pi}</math></p> |
|---|--|---|

Values at Half-Periods

|                                  | $\mathcal{P}$ | $\mathcal{P}'$ | $\zeta$                         | $\sigma$                        |
|----------------------------------|---------------|----------------|---------------------------------|---------------------------------|
| 18.15.6 $\omega \equiv \omega_1$ | $i/2$         | 0              | $\frac{1}{2}(\eta_2 - \eta_2')$ | $e^{-i\pi/4}e^{\pi/8}(2^{1/4})$ |
| 18.15.7 $\omega_2$               | 0             | 0              | $\eta_2 = \pi/2\omega_2$        | $e^{\pi/4}\sqrt{2}$             |
| 18.15.8 $\omega' = \omega_3$     | $-i/2$        | 0              | $\frac{1}{2}(\eta_2 + \eta_2')$ | $e^{i\pi/4}e^{\pi/8}(2^{1/4})$  |
| 18.15.9 $\omega_2'$              | 0             | 0              | $\eta_2' = -i\eta_2$            | $i\sigma(\omega_2)$             |

Relations with Lemniscatic Values

- |  |  |  |
|--|--|--|
| <p>18.15.10 <math>\mathcal{P}(z; -1, 0) = i\mathcal{P}(ze^{i\pi/4}; 1, 0)</math></p> <p>18.15.11 <math>\mathcal{P}'(z; -1, 0) = e^{3\pi/4}\mathcal{P}'(ze^{i\pi/4}; 1, 0)</math></p> |  | <p>18.15.12 <math>\zeta(z; -1, 0) = e^{i\pi/4}\zeta(ze^{i\pi/4}; 1, 0)</math></p> <p>18.15.13 <math>\sigma(z; -1, 0) = e^{-i\pi/4}\sigma(ze^{i\pi/4}; 1, 0)</math></p> |
|--|--|--|

Numerical Methods

18.16. Use and Extension of the Tables

Example 1. Lemniscatic Case

(a) Given  $z = x + iy$  in the Fundamental Triangle, find  $\mathcal{P}(\mathcal{P}', \zeta, \sigma)$  more accurately than can be done with the maps.

$\sigma$ —Use Maclaurin series throughout the Fundamental Triangle. Five terms give at least six significant figures, six terms at least ten.  $\mathcal{P}, \zeta$ —Use Laurent's series directly "near" 0, (if  $|z| < 1$ , four terms give at least eight significant figures for  $\mathcal{P}$ , nine for  $\zeta$ ; five terms at least ten significant figures for  $\mathcal{P}$ , eleven for  $\zeta$ ). Use Taylor's series directly "near"  $z_0$ . Elsewhere (unless approximately seven or eight significant figures are insufficient) use economized polynomials to obtain  $\mathcal{P}(x), \mathcal{P}'(x)$  and/or  $\zeta(x)$  as appropriate. To get  $\mathcal{P}(iy), \mathcal{P}'(iy)$  and/or  $\zeta(iy)$ , use Laurent's series for "small"  $y$ , otherwise use economized polynomials to compute  $\mathcal{P}(y), \mathcal{P}'(y)$  and/or  $\zeta(y)$ , then use complex multiplication to obtain  $\mathcal{P}(iy), \mathcal{P}'(iy)$  and/or  $\zeta(iy)$ . Finally, use appropriate addition formula to get  $\mathcal{P}(z)$  and/or  $\zeta(z)$ .

$\mathcal{P}'$ —Use Laurent's series directly "near" 0 (if  $|z| < 1$ , four terms give at least six significant figures, five terms at least eight significant figures). Elsewhere, either use economized polynomials and addition formula as for  $\mathcal{P}$  and  $\zeta$ , or get  $\mathcal{P}'^2 = 4\mathcal{P}^3 - \mathcal{P}$  and extract appropriate square root ( $\mathcal{P}' \geq 0$ ).

(b) Given  $\mathcal{P}(\mathcal{P}', \zeta, \sigma)$  corresponding to a point in the Fundamental Triangle, compute  $z$  more accurately than can be done with the maps. Only a few significant figures are obtainable from the use of any of the given (truncated) reversed series, except in a small neighborhood of the center of the series. For greater accuracy, use inverse interpolation procedures.

Example 2. Equianharmonic Case

(a) Given  $z = x + iy$  in the Fundamental Triangle, find  $\mathcal{P}(\mathcal{P}', \zeta, \sigma)$  more accurately than can be done with the maps.

$\sigma$ —Use Maclaurin series throughout the Fundamental Triangle. Four terms give at least eleven significant figures, five terms at least twenty one.

$\mathcal{P}, \zeta$ —Use Laurent's series directly "near" 0 (if  $|z| < 1$ , four terms give at least 10S for  $\mathcal{P}$ , 11S for  $\zeta$ ; five terms at least 13S for  $\mathcal{P}$ , 14S for  $\zeta$ ). Elsewhere (unless approximately seven or eight significant figures are insufficient) use economized polynomials to obtain  $\mathcal{P}(x), \mathcal{P}'(x)$  and/or  $\zeta(x)$ , as appropriate. To get  $\mathcal{P}(iy), \mathcal{P}'(iy)$  and/or  $\zeta(iy)$ , use Laurent's series. Then use appropriate addition formula to get  $\mathcal{P}(z)$  and/or  $\zeta(z)$ .

$\mathcal{P}'$ —Use Laurent's series directly "near" 0 (if  $|z| < 1$ , four terms give at least 8S, five terms at least 11S). Elsewhere, either proceed as for  $\mathcal{P}$  and  $\zeta$ , or get  $\mathcal{P}'^2 = 4\mathcal{P}^3 - 1$  and extract appropriate square root ( $\mathcal{G}\mathcal{P}' \geq 0$ ).

(b) Given  $\mathcal{P}(\mathcal{P}', \zeta, \sigma)$  corresponding to a point in the Fundamental Triangle, compute  $z$  more accurately than can be done with the maps. Only a few significant figures are obtainable from the use of any of the given (truncated) reversed series, except in a small neighborhood of the center of the series. For greater accuracy, use inverse interpolation procedures.

**Example 3.** Given period ratio  $a$ , find parameters  $m$  (of elliptic integrals and Jacobi's functions of chapter 16) and  $q$  (of  $\vartheta$  functions).

$m$ —In both the cases  $\Delta > 0$  and  $\Delta < 0$ , the period ratio is equal to  $K'(m)/K(m)$  (see 18.9). Knowing  $K'/K$ , if  $1 < K'/K \leq 3$ , use **Table 17.3** to find  $m$ ; if  $K'/K > 3$ , use the method of **Example 6** in chapter 17. An alternative method is to use **Table 18.3** to obtain the necessary entries, thence use

$$m = (e_2 - e_3)/(e_1 - e_3) \text{ in case } \Delta > 0,$$

$$m = \frac{1}{2} - 3e_2/4H_2 \text{ in case } \Delta < 0.$$

$q$ —In both the cases  $\Delta > 0$  and  $\Delta < 0$ , the period ratio determines the exponent for  $q$  [ $q = e^{-\pi a}$  if  $\Delta > 0$ ,  $q = ie^{-\pi a/2}$  if  $\Delta < 0$ ]. Hence enter **Table 4.16** [ $e^{-x^2}$ ,  $x = 0(.01)1$ ] and multiply the results as appropriate [e.g.,  $e^{-4.72x} = (e^{-x})^4(e^{-.72x})$ ].

**Determination of Values at Half-Periods, Invariants and Related Quantities from Given Periods (Table 18.3)**

$\Delta > 0$

Given  $\omega$  and  $\omega'$ , form  $\omega'/i\omega$  and enter **Table 18.3**. Multiply the results obtained by the appropriate power of  $\omega$  (see footnotes of **Table 18.3**) to obtain value desired.

**Example 4.**

Given  $\omega = 10$ ,  $\omega' = 11i$ , find  $e_i$ ,  $g_i$ , and  $\Delta$ .

Here  $\omega'/i\omega = 1.1$ , so that direct reading of **Table 18.3** gives

$$\begin{aligned} e_1(1) &= 1.6843 \ 041 \\ e_2(1) &= -.2166 \ 258 \ (= -e_1 - e_3) \\ e_3(1) &= -1.4676 \ 783 \\ g_2(1) &= 10.0757 \ 7364 \\ g_3(1) &= 2.1420 \ 1000. \end{aligned}$$

Multiplying by appropriate powers of  $\omega = 10$  we obtain

$$\begin{aligned} e_1 &= .01684 \ 3041 \\ e_2 &= -.00216 \ 6258 \\ e_3 &= -.01467 \ 6783 \\ g_2 &= 1.0075 \ 77364 \times 10^{-3} \\ g_3 &= 2.1420 \ 1000 \times 10^{-6} \end{aligned}$$

whence

$$\Delta = 8.9902 \ 3191 \times 10^{-10}$$

$\Delta < 0$

Given  $\omega_2$  and  $\omega_2'$ , form  $\omega_2'/i\omega_2$  and enter **Table 18.3**. Multiply the results obtained by the appropriate power of  $\omega_2$  (see footnotes of **Table 18.3**) to obtain value desired.

**Example 4.**

Given  $\omega_2 = 10$ ,  $\omega_2' = 11i$ , find  $e_i$ ,  $g_i$ , and  $\Delta$ .

Here  $\omega_2'/i\omega_2 = 1.1$ , so that direct reading of **Table 18.3** gives

$$\begin{aligned} e_1(1) &= -.2166 \ 2576 + 3.0842 \ 589i \\ e_2(1) &= .4332 \ 5152 = -2\mathcal{R}(e_1) \\ e_3(1) &= \bar{e}_1(1) \\ g_2(1) &= -37.4874 \ 912 \\ g_3(1) &= 16.5668 \ 099. \end{aligned}$$

Multiplying by appropriate powers of  $\omega_2 = 10$  we obtain

$$\begin{aligned} e_1 &= -.00216 \ 62576 + .03084 \ 2589i \\ e_2 &= .00433 \ 25152 \\ e_3 &= \bar{e}_1 \\ g_2 &= -3.7487 \ 4912 \times 10^{-3} \\ g_3 &= 1.6566 \ 8099 \times 10^{-5} \end{aligned}$$

whence

$$\Delta = -6.0092 \ 019 \times 10^{-8}$$



Computation of  $\sigma$  for Given  $x$  and Arbitrary  $g_2$  and  $g_3$

(or periods from which  $g_2$  and  $g_3$  can be computed—in any case, periods must be known, at least approximately)

First reduce the problem (if necessary) to computation for a point  $z$  in the Fundamental Rectangle (see 18.2). After final reduction let  $z$  denote the point obtained.

$\Delta > 0$

If  $\Re z > \omega/2$  or,

$\Im z > \omega'/2$ , use duplication formula

$$\sigma(z) = -\mathcal{P}'(z/2)\sigma^A(z/2),$$

obtaining  $\sigma(z/2)$  by use of Maclaurin series for  $\sigma$  and  $\mathcal{P}'(z/2)$  by method explained above. Otherwise, simply use Maclaurin series for  $\sigma$  directly.

An alternate method is to use theta functions 18.10 first computing  $q$  and  $\vartheta_i(0)$ ,  $i=2, 3, 4$ .

$\Delta > 0$

**Example 13.** Compute  $\sigma(.4+1.3i)$  for  $g_2=8$ ,  $g_3=4$ . From **Example 7**,  $\omega=1.009453$  and  $\omega'=1.484413i$ . Since  $\Im z > \omega'/2$ , the Maclaurin series 18.5.6 is used to obtain  $\sigma(z/2)=\sigma(.2+.65i)=.1954386+.6494728i$ , the Laurent series 18.5.4 to obtain  $\mathcal{P}'(.2+.65i)=5.0225380-3.5606693i$ . The duplication formula 18.4.8 gives  $\sigma(.4+1.3i)=.278080+1.272785i$ .

Given  $\sigma(\mathcal{P}, \mathcal{P}', \zeta)$  corresponding to a point in the Fundamental Rectangle, as well as  $g_2$  and  $g_3$  or the equivalent, find  $z$ .

Only a few significant figures are obtainable from the use of any of the given (truncated) reversed series, except in a small neighborhood of the center of the series. For greater accuracy, use inverse interpolation procedures.

If the given function does not correspond to a value of  $z$  in the Fundamental Rectangle (see Conformal Maps) the problem can always be reduced to this case by the use of appropriate reduction formulas in 18.2. This process is relatively simple for  $\mathcal{P}(z)$ , more difficult for the other functions (e.g. if  $\Delta > 0$  and  $\mathcal{P}=a+ib$ , where  $b > 0$ , simply consider  $\overline{\mathcal{P}}=a-ib$  and find  $z_1$  in  $R_1$  [Figure 18.1]; then compute  $z_2=\overline{z_1}+2\omega'$ , the point in  $R_2$  corresponding to the given  $\mathcal{P}$ ).

$\Delta > 0$

**Example 14.** Given  $\mathcal{P}=1-i$ ,  $g_2=10$ ,  $g_3=2$ , find  $z$ . Using the first three terms of the reversed series 18.5.25  $z_1 \approx .727+.423i$ . The Laurent series 18.5.1 gives

$$\mathcal{P}(z_1) = \mathcal{P}(.727+.423i) = .825-.895i$$

and

$$\mathcal{P}(z_2) = \mathcal{P}(.697+.393i) = .938-1.038i.$$

Inverse interpolation gives  $z_1^{(1)} = .707+.380i$ . Repeated applications of the above procedure yield  $z = .706231+.379893i$ .

$\Delta < 0$

If  $\Re z > \omega_2/2$  or

$\Im z > \omega'_2/4$ , use duplication formula as in case  $\Delta > 0$ . Otherwise, use Maclaurin series for  $\sigma$  directly.

$\Delta < 0$

**Example 13.** Compute  $\sigma(.8+.4i)$  for  $g_2=7$ ,  $g_3=6$ . From **Example 7**,  $\omega_2=.99579976$ ,  $\omega'_2=2.3324183i$ . Since  $\Re z > \omega_2/2$ , the Maclaurin series 18.5.6 is used to obtain  $\sigma(z/2)=\sigma(.4+.2i)=.40038019+.19962017i$ , the Laurent series 18.5.4 to obtain  $\mathcal{P}'(.4+.2i)=-3.7098670+22.218544i$ . The duplication formula 18.4.8 gives  $\sigma(.8+.4i)=.81465765+.38819473i$ .

$\Delta < 0$

**Example 14.** Given  $\mathcal{P}=1+i$ ,  $g_2=-10$ ,  $g_3=2$ , find  $z$ . From **Example 6**,  $\omega_2=1.4023948$  and  $\omega'_2=1.5256102i$ . Since  $b > 0$ ,  $z$  exists in  $R_2$  and  $z$  is computed with  $\overline{\mathcal{P}}$ . Using 18.5.25 with  $\alpha_2=-1.25$ ,  $\alpha_3=.25$ ,  $u=[(\overline{\mathcal{P}})^{-1}]^{1/2}$  and the coefficients  $c_n$  from **Example 8**

$$2u = 1.553773973+.6435942493i$$

$$c_2u^5 = .080449281-.1942217466i$$

$$c_3u^7 = -.019619359+.0081266047i$$

$$\frac{\alpha_2^2 u^9}{3} = -.101157160-.0419006673i$$



$\Delta > 0$ 

**Example 15.** Given  $\zeta = 10 - 15i$ ,  $g_2 = 8$ ,  $g_3 = 4$ , find  $z$ . Using the reversed series 18.5.40 with

$$A_5 = -.13333\ 333,$$

$$A_7 = -.02857\ 14286,$$

$$u = .03076\ 923076 + .04615\ 384615i$$

$$A_5 u^5 = -.00000\ 001402 + .00000\ 006860i$$

$$A_7 u^7 = -.00000\ 000004 - .00000\ 000003i$$

$$z = .03076\ 921670 + .04615\ 391472i.$$

 $\Delta < 0$ 

Stopping with the term in  $u^7$ ,  $z_1 \approx .81 + .23i$ . Assuming  $\Delta z = -.03 - .01i$ , using 18.5.1,  $\mathcal{P}(.81 + .23i) = .91410\ 95 - .86824\ 37i$ ,  $\mathcal{P}(.78 + .22i) = 1.03191\ 60 - .91795\ 22i$ ; with inverse interpolation  $z_1^{(1)} = .7725 + .2404i$ . Repeated applications of inverse interpolation yield  $z = .772247 - .239258i$ .

**Example 15.** Given  $\sigma = .4 + .1i$ ,  $g_2 = 7$ ,  $g_3 = 6$ , find  $z$ . Using the reversed series 18.5.70 with  $\gamma_2 = .14583$ ,  $\gamma_3 = .05$

$$\sigma = +.40000\ 000 + .10000\ 000i$$

$$\frac{\gamma_2 \sigma^5}{5} = +.00011\ 783 + .00032\ 696i$$

$$\frac{\gamma_3 \sigma^7}{7} = -.00000\ 208 + .00001\ 432i$$

$$\frac{3\gamma_2^2 \sigma^9}{14} = -.00000\ 093 + .00000\ 126i$$

$$\frac{19\gamma_2\gamma_3\sigma^{11}}{55} = -.00000\ 013 + .00000\ 006i$$

$$z = .40011\ 469 + .10034\ 260i$$

**Methods of Computation of  $\mathcal{P}$  ( $\mathcal{P}'$ ,  $\zeta$  or  $\sigma$ ) for Given  $z$  and Given  $g_2$ ,  $g_3$  (or the equivalent), with the Use of Automatic Digital Computing Machinery**

(a) Integration of Differential Equation

$\mathcal{P}$  and  $\mathcal{P}'$  may be generated for any  $z$  close enough to a "known point"  $z^*$  ( $\mathcal{P}(z^*)$  and  $\mathcal{P}'(z^*)$  being given) by integrating  $\mathcal{P}'' = 6\mathcal{P}^2 - g_2/2$ . A program to do this on SWAC, via a modification of the Hammer-Hollingsworth method (MTAC, July 1955, pp. 92-96) due to Dr. P. Henrici, exists at Numerical Analysis Research, UCLA (code number 00600, written by W. L. Wilson, Jr.). The program has been tested numerically in the equianharmonic case, using integration steps of various sizes. For example, if one starts with  $z^* = \omega_2$ , using an "integration step"  $(h, k)$ , where  $h$  and  $k$  are respectively the horizontal and vertical components of a step, with  $(h, k)$  having one of the six values  $(\pm 2h_0, 0)$ ,  $(\pm h_0, \pm k_0)$ ,  $h_0 = \omega_2/2000$ ,  $k_0 = |\omega_2'|/2000$ , one can expect almost 8S in  $\mathcal{P}$  and 7S in  $\mathcal{P}'$  after 1000 steps, unless  $z$  is too near a pole.

(b) Use of Series

The process of reducing the computation problem to one in which  $z$  is in the Fundamental Rectangle can obviously be mechanized. Inside the Fundamental Rectangle the direct use of Laurent's series is appropriate when the period

ratio  $a$  is not too large. However, if  $a \geq \sqrt{3}$  ( $\Delta > 0$ ) or  $a \geq 2\sqrt{3}$  ( $\Delta < 0$ ), the series will diverge at the far corner of the Fundamental Rectangle, so that use may be made of an appropriate duplication formula. Alternatively, one may compute the functions on  $0x$  and  $0y$ , then use an addition formula. Even so, the series will diverge at  $z = ia$  if  $a \geq 2$  ( $\Delta > 0$ ) and at  $z = ia/2$  if  $a \geq 4$  ( $\Delta < 0$ ).

For great accuracy, multiple precision operations might be necessary. Double precision floating point mode has been used in a program, written for SWAC, to compute  $\mathcal{P}$ ,  $\mathcal{P}'$  and  $\zeta$ .

For computation of  $\sigma$ , use of the Maclaurin series throughout the Fundamental Rectangle is probably simplest (series converges for all  $z$ ).

Mention should be made of the possible use of the series defining the  $\mathcal{P}$  functions. These series converge for all complex  $v$ , and the computation of  $\mathcal{P}$ ,  $\mathcal{P}'$ ,  $\zeta$  and  $\sigma$  by 18.10.5-18.10.8 could easily be mechanized. The series involved have the advantage of converging very fast, even in case  $\Delta < 0$ , where  $|q| \leq e^{-\pi/2}$  ( $q \leq e^{-\pi}$  if  $\Delta > 0$ ).

*Use of Maps*

If the problem (of computing  $\mathcal{P}$ ,  $\mathcal{P}'$ ,  $\zeta$  or  $\sigma$  for given  $z$ ) is reduced to the case where the real half-period is unity and imaginary half-period is one of those used in the maps in 18.8 inspection of the

appropriate figure will give the value of  $\mathcal{P}(z)$  [ $\xi(z)$  or  $\sigma(z)$ ] to 2-3S. If  $\mathcal{P}'$  is wanted instead, get  $\mathcal{P}$ , use 18.6.3 to obtain  $\mathcal{P}'^2$  and select sign ( $s$ ) of  $\mathcal{P}'$  appropriately. (See Conformal Mapping (18.8) for choice of sign of square root of  $\mathcal{P}'^2$ ).

#### Computation of $z_0$

Given  $g_2, g_3$  (or equivalent)

Since  $z_0^2 \mathcal{P}(z_0) = 0$ , the Laurent's series gives

$$0 = 1 + c_2 u^2 + c_3 u^3 + c_4 u^4 + \dots$$

where  $u = z_0^2$ . We may solve this equation [by Graeffe's (root-squaring) process or otherwise] for its absolutely smallest root [having found an

approximation to  $|z_0|$  by Graeffe's process, we may use the fact that  $z_0 = \omega + iy_0 (\Delta > 0)$ ,  $z_0 = \omega_2 + iy_0 (\Delta < 0)$  to obtain an approximation to  $z_0$ ].

It is noted that  $y_0/\omega$  is a monotonic decreasing function of (period ratio)  $a \geq 1$  for  $\Delta > 0$  and

$$[1 \geq y_0/\omega > \frac{2}{\pi} \operatorname{arccosh} \sqrt{3} (\approx .7297)].$$

$y_0/\omega_2$  is a monotonic increasing function of  $a$  for  $\Delta < 0$  and

$$[0 \leq y_0/\omega_2 < \frac{2}{\pi} \operatorname{arccosh} \sqrt{3}]$$

Further data is available from Table 18.2 or from Conformal Maps defined by  $\mathcal{P}(z)$ .

## References

### Texts and Articles

- [18.1] P. Appell and E. Lacour, Principes de la théorie des fonctions elliptiques et applications (Gauthier-Villars, Paris, France, 1897).
- [18.2] A. Erdélyi et al., Higher transcendental functions, vol. 2, ch. 13 (McGraw-Hill Book Co., Inc., New York, N.Y., 1953).
- [18.3] E. Graeser, Einführung in die Theorie der elliptischen Funktionen und deren Anwendungen (R. Oldenbourg, Munich, Germany, 1950).
- [18.4] G. H. Halphen, Traité des fonctions elliptiques et de leurs applications, 1 (Gauthier-Villars, Paris, France, 1886).
- [18.5] H. Hancock, Lectures on the theory of elliptic functions, vol. 1 (John Wiley & Sons, Inc., New York, N.Y., 1910, reprinted, Dover Publications, Inc., New York, N.Y., 1958).
- [18.6] A. Hurwitz and R. Courant, Vorlesungen über allgemeine Funktionentheorie und elliptische Funktionen, 3d ed. (Springer, Berlin, Germany, 1929).
- [18.7] E. L. Ince, Ordinary differential equations (Dover Publications, Inc., New York, N.Y., 1944).
- [18.8] E. Kamke, Differentialgleichungen, Lösungsmethoden und Lösungen, vol. 1, 2d ed. (Akademische Verlagsgesellschaft, Leipzig, Germany, 1943).
- [18.9] D. H. Lehmer, The lemniscate constant, Math. Tables Aids Comp. 3, 550-551 (1948-49).
- [18.10] S. C. Mitra, On the expansion of the Weierstrassian and Jacobian elliptic functions in powers of the argument, Bull. Calcutta Math. Soc. 17, 159-172 (1926).
- [18.11] F. Oberhettinger and W. Magnus, Anwendung der elliptischen Funktionen in Physik und Technik (Springer, Berlin, Germany, 1949).
- [18.12] G. Prasad, An introduction to the theory of elliptic functions and higher transcendentals (Univ. of Calcutta, India, 1928).
- [18.13] U. Richard, Osservazioni sulla bisezione delle funzioni ellittiche di Weierstrass, Boll. Un. Mat. Ital. 3, 4, 395-397 (1949).
- [18.14] E. S. Selmer, A simple trisection formula for the elliptic function of Weierstrass in the equianharmonic case, Norske Vid. Selsk. Forh. Trondheim 19, 29, 116-119 (1947).
- [18.15] J. Tannery and J. Molk, Éléments de la théorie des fonctions elliptiques, 4 vols. (Gauthier-Villars, Paris, France, 1893-1902).
- [18.16] F. Tricomi, Elliptische Funktionen (Akademische Verlagsgesellschaft, Leipzig, Germany, 1948).
- [18.17] F. Tricomi, Funzioni ellittiche, 2d ed. (Bologna, Italy, 1951).
- [18.18] C. E. Van Orstrand, Reversion of power series, Phil. Mag. (6) 19, 366-376 (Jan.-June 1910).
- [18.19] E. T. Whittaker and G. N. Watson, A course of modern analysis, ch. 20, 4th ed. (Cambridge Univ. Press, Cambridge, England, 1952).

### Guides, Collections of Formulas, etc.

- [18.20] P. F. Byrd and M. D. Friedman, Handbook of elliptic integrals for engineers and physicists, Appendix, sec. 1030 (Springer-Verlag, Berlin, Germany, 1954).
- [18.21] A. Fletcher, Guide to tables of elliptic functions, Math. Tables Aids Comp. 3, 247-249 (1948-49).
- [18.22] S. Flügge, Handbuch der Physik, vol. 1, pp. 120-146 (Springer-Verlag, Berlin, Germany, 1956).
- [18.23] H. Kober, Dictionary of conformal representations (Dover Publications, Inc., New York, N.Y., 1952).
- [18.24] L. M. Milne-Thomson, Jacobian elliptic function tables (Dover Publications, Inc., New York, N.Y., 1950).
- [18.25] K. Weierstrass and H. A. Schwarz, Formeln und Lehrsätze zum Gebrauche der elliptischen Funktionen. Nach Vorlesungen und Aufzeichnungen des Herrn K. Weierstrass bearbeitet und herausgegeben von H. A. Schwarz, 2d ed. (Springer, Berlin, Germany, 1893).

## Tables

- [18.26] Chih-Bing Ling, Evaluation at half-periods of Weierstrass' elliptic function with rectangular primitive period-parallelogram, *Math. Comp.* **14**, 69, 67-70 (1960). Values of  $e_i$  ( $i=1, 2, 3$ ) to 15D for various period ratios in case  $\Delta > 0$ .
- [18.27] E. Jahnke and F. Emde, *Tables of functions*, 4th ed., pp. 100-106 (Dover Publications, Inc., New York, N.Y., 1945). Equianharmonic case, real argument,  $\mathcal{P}(u), \mathcal{P}'(u), \zeta(u), \sigma(u), u=0\left(\frac{\omega_2}{180}\right)$   $\frac{4\omega_2}{3}$ , mostly 4D.
- [18.28] T. H. Southard, Approximation and table of the Weierstrass  $\mathcal{P}$  function in the equianharmonic case for real argument, *Math. Tables Aids Comp.* **11**, 58, 99-100 (Apr. 1957).  $f(u) = \mathcal{P}(u) - \frac{1}{u^2}$  to 7D, with modified central differences,  $u=0(.1).8(.05)1.55$ .
- [18.29] D. A. Strayhorne, A study of an elliptic function (Thesis, Chicago, Ill., 1946). Air Documents Division T-2, AMC, Wright Field, Microfilm No. Rc-734F15000.  $\mathcal{P}(z; 37, -42)$ , 4D,  $z=.04i(.04i)1.36i$ .



# 19. Parabolic Cylinder Functions

J. C. P. MILLER<sup>1</sup>

## Contents

|  | Page |
|--|------|
| <b>Mathematical Properties</b> . . . . .   | 686  |
| <b>19.1. The Parabolic Cylinder Functions, Introductory</b> . . . . .  | 686  |
| <b>The Equation</b> $\frac{d^2y}{dx^2} - (\frac{1}{4}x^2 + a)y = 0$  |      |
| <b>19.2 to 19.6. Power Series, Standard Solutions, Wronskian and Other Relations, Integral Representations, Recurrence Relations</b> . . . . . | 686  |
| <b>19.7 to 19.11. Asymptotic Expansions</b> . . . . .  | 689  |
| <b>19.12 to 19.15. Connections With Other Functions</b> . . . . .  | 691  |
| <b>The Equation</b> $\frac{d^2y}{dx^2} + (\frac{1}{4}x^2 - a)y = 0$  |      |
| <b>19.16 to 19.19. Power Series, Standard Solutions, Wronskian and Other Relations, Integral Representations</b> . . . . .                     | 692  |
| <b>19.20 to 19.24. Asymptotic Expansions</b> . . . . .   | 693  |
| <b>19.25. Connections With Other Functions</b> . . . . .   | 695  |
| <b>19.26. Zeros</b> . . . . .  | 696  |
| <b>19.27. Bessel Functions of Order <math>\pm\frac{1}{4}</math>, <math>\pm\frac{3}{4}</math> as Parabolic Cylinder Functions</b> . . . . .     | 697  |
| <b>Numerical Methods</b> . . . . .   | 697  |
| <b>19.28. Use and Extension of the Tables</b> . . . . .  | 697  |
| <b>References</b> . . . . .  | 700  |
| <b>Table 19.1. <math>U(a, x)</math> and <math>V(a, x)</math> (<math>0 \leq x \leq 5</math>)</b> . . . . .                                      | 702  |
| $\pm a = 0(.1)1(.5)5; x = 0(.1)5, 5S$  |      |
| <b>Table 19.2. <math>W(a, \pm x)</math> (<math>0 \leq x \leq 5</math>)</b> . . . . .   | 712  |
| $\pm a = 0(.1)1(1)5; x = 0(.1)5, 4-5D$ or $S$  |      |
| <b>Table 19.3. Auxiliary Functions</b> . . . . .   | 720  |

The author acknowledges permission from H.M. Stationery Office to draw freely from [19.11] the material in the introduction, and the tabular values of  $W(a, x)$  for  $a = .5(1)5, \pm x = 0(.1)5$ . Other tables of  $W(a, x)$  and the tables of  $U(a, x)$  and  $V(a, x)$  were prepared on EDSAC 2 at the University Mathematical Laboratory, Cambridge, England, using a program prepared by Miss Joan Walsh for solution of general second order linear homogeneous differential equations with quadratic polynomial coefficients. The auxiliary tables were prepared at the Computation Laboratory of the National Bureau of Standards.

---

<sup>1</sup> The University Mathematical Laboratory, Cambridge, England. (Prepared under contract with the National Bureau of Standards.)

# 19. Parabolic Cylinder Functions

## Mathematical Properties

### 19.1. The Parabolic Cylinder Functions

#### Introductory

These are solutions of the differential equation

$$19.1.1 \quad \frac{d^2y}{dx^2} + (ax^2 + bx + c)y = 0$$

with two real and distinct standard forms

$$19.1.2 \quad \frac{d^2y}{dx^2} - (\frac{1}{4}x^2 + a)y = 0$$

$$19.1.3 \quad \frac{d^2y}{dx^2} + (\frac{1}{4}x^2 - a)y = 0$$

The functions

#### 19.1.4

$$y(a, x) \quad y(a, -x) \quad y(-a, ix) \quad y(-a, -ix)$$

are all solutions either of 19.1.2 or of 19.1.3 if any one is such a solution.

Replacement of  $a$  by  $-ia$  and  $x$  by  $xe^{i\pi}$  converts 19.1.2 into 19.1.3. If  $y(a, x)$  is a solution of 19.1.2, then 19.1.3 has solutions:

#### 19.1.5

$$y(-ia, xe^{i\pi}) \quad y(-ia, -xe^{i\pi}) \\ y(ia, -xe^{-i\pi}) \quad y(ia, xe^{-i\pi})$$

Both variable  $x$  and the parameter  $a$  may take on general complex values in this section and in many subsequent sections. Practical applications appear to be confined to real solutions of real equations; therefore attention is confined to such solutions, and, in general, formulas are given for the two equations 19.1.2 and 19.1.3 independently. The principal computational consequence of the remarks above is that reflection in the  $y$ -axis produces an independent solution in almost all cases (Hermite functions provide an exception), so that tables may be confined either to positive  $x$  or to a single solution of 19.1.2 or 19.1.3.

**The Equation**  $\frac{d^2y}{dx^2} - \left(\frac{1}{4}x^2 + a\right)y = 0$

#### 19.2. Power Series in $x$

Even and odd solutions of 19.1.2 are given by

#### 19.2.1

$$y_1 = e^{-\frac{1}{2}x^2} M\left(\frac{1}{2}a + \frac{1}{4}, \frac{1}{2}, \frac{1}{2}x^2\right) \\ = e^{-\frac{1}{2}x^2} \left\{ 1 + (a + \frac{1}{2}) \frac{x^2}{2!} + (a + \frac{1}{2})(a + \frac{3}{2}) \frac{x^4}{4!} + \dots \right\} \\ = e^{-\frac{1}{2}x^2} {}_1F_1\left(\frac{1}{2}a + \frac{1}{4}; \frac{1}{2}; \frac{1}{2}x^2\right)$$

#### 19.2.2

$$= e^{\frac{1}{2}x^2} M\left(-\frac{1}{2}a + \frac{1}{4}, \frac{1}{2}, -\frac{1}{2}x^2\right) \\ = e^{\frac{1}{2}x^2} \left\{ 1 + (a - \frac{1}{2}) \frac{x^2}{2!} + (a - \frac{1}{2})(a - \frac{3}{2}) \frac{x^4}{4!} + \dots \right\}$$

#### 19.2.3

$$y_2 = xe^{-\frac{1}{2}x^2} M\left(\frac{1}{2}a + \frac{3}{4}, \frac{3}{2}, \frac{1}{2}x^2\right) \\ = e^{-\frac{1}{2}x^2} \left\{ x + (a + \frac{3}{2}) \frac{x^3}{3!} + (a + \frac{3}{2})(a + \frac{1}{2}) \frac{x^5}{5!} + \dots \right\}$$

#### 19.2.4

$$= xe^{\frac{1}{2}x^2} M\left(-\frac{1}{2}a + \frac{3}{4}, \frac{3}{2}, -\frac{1}{2}x^2\right) \\ = e^{\frac{1}{2}x^2} \left\{ x + (a - \frac{3}{2}) \frac{x^3}{3!} + (a - \frac{3}{2})(a - \frac{1}{2}) \frac{x^5}{5!} + \dots \right\}$$

these series being convergent for all values of  $x$  (see chapter 13 for  $M(a, c, z)$ ).

Alternatively,

#### 19.2.5

$$y_1 = 1 + a \frac{x^2}{2!} + \left(a^2 + \frac{1}{2}\right) \frac{x^4}{4!} + \left(a^3 + \frac{7}{2}a\right) \frac{x^6}{6!} \\ + \left(a^4 + 11a^2 + \frac{15}{4}\right) \frac{x^8}{8!} + \left(a^5 + 25a^3 + \frac{211}{4}a\right) \frac{x^{10}}{10!} + \dots$$

#### 19.2.6

$$y_2 = x + a \frac{x^3}{3!} + \left(a^2 + \frac{3}{2}\right) \frac{x^5}{5!} + \left(a^3 + \frac{13}{2}a\right) \frac{x^7}{7!} \\ + \left(a^4 + 17a^2 + \frac{63}{4}\right) \frac{x^9}{9!} + \left(a^5 + 35a^3 + \frac{531}{4}a\right) \frac{x^{11}}{11!} + \dots$$

in which non-zero coefficients  $a_n$  of  $x^n/n!$  are connected by

$$19.2.7 \quad a_{n+2} = a \cdot a_n + \frac{1}{4} n(n-1) a_{n-2}$$

19.3. Standard Solutions

These have been chosen to have the asymptotic behavior exhibited in 19.8. The first is Whittaker's function [19.8, 19.9] in a more symmetrical notation.

19.3.1

$$U(a, x) = D_{-a-\frac{1}{2}}(x) = \cos \pi(\frac{1}{4} + \frac{1}{2}a) \cdot Y_1 - \sin \pi(\frac{1}{4} + \frac{1}{2}a) \cdot Y_2$$

19.3.2

$$V(a, x) = \frac{1}{\Gamma(\frac{1}{2}-a)} \{ \sin \pi(\frac{1}{4} + \frac{1}{2}a) \cdot Y_1 + \cos \pi(\frac{1}{4} + \frac{1}{2}a) \cdot Y_2 \}$$

in which

19.3.3  $Y_1 = \frac{1}{\sqrt{\pi}} \frac{\Gamma(\frac{1}{4}-\frac{1}{2}a)}{2^{1/2}a+1} y_1 = \sqrt{\pi} \frac{\sec \pi(\frac{1}{4} + \frac{1}{2}a)}{2^{1/2}a+1\Gamma(\frac{3}{4} + \frac{1}{2}a)} y_1$

19.3.4  $Y_2 = \frac{1}{\sqrt{\pi}} \frac{\Gamma(\frac{3}{4}-\frac{1}{2}a)}{2^{1/2}a-1} y_2 = \sqrt{\pi} \frac{\csc \pi(\frac{1}{4} + \frac{1}{2}a)}{2^{1/2}a-1\Gamma(\frac{1}{4} + \frac{1}{2}a)} y_2$

19.3.5

$$U(a, 0) = \frac{\sqrt{\pi}}{2^{1/2}a+1\Gamma(\frac{3}{4} + \frac{1}{2}a)} \quad U'(a, 0) = -\frac{\sqrt{\pi}}{2^{1/2}a-1\Gamma(\frac{1}{4} + \frac{1}{2}a)}$$

19.3.6

$$V(a, 0) = \frac{2^{1/2}a+1 \sin \pi(\frac{3}{4} - \frac{1}{2}a)}{\Gamma(\frac{3}{4} - \frac{1}{2}a)} \quad V'(a, 0) = \frac{2^{1/2}a+1 \sin \pi(\frac{1}{4} - \frac{1}{2}a)}{\Gamma(\frac{1}{4} - \frac{1}{2}a)}$$

In terms of the more familiar  $D_n(x)$  of Whittaker,

19.3.7  $U(a, x) = D_{-a-\frac{1}{2}}(x)$

19.3.8

$$V(a, x) = \frac{1}{\pi} \Gamma(\frac{1}{2}+a) \{ \sin \pi a \cdot D_{-a-\frac{1}{2}}(x) + D_{-a-\frac{1}{2}}(-x) \}$$

19.4. Wronskian and Other Relations

19.4.1  $W\{U, V\} = \sqrt{2/\pi}$

19.4.2

$$\pi V(a, x) = \Gamma(\frac{1}{2}+a) \{ \sin \pi a \cdot U(a, x) + U(a, -x) \}$$

19.4.3

$$\Gamma(\frac{1}{2}+a)U(a, x) = \pi \sec^2 \pi a \{ V(a, -x) - \sin \pi a \cdot V(a, x) \}$$

19.4.4

$$\frac{\Gamma(\frac{1}{4}-\frac{1}{2}a) \cos \pi(\frac{1}{4} + \frac{1}{2}a)}{\sqrt{\pi}2^{1/2}a-1} y_1 = 2 \sin \pi(\frac{3}{4} + \frac{1}{2}a) \cdot Y_1 = U(a, x) + U(a, -x)$$

19.4.5

$$-\frac{\Gamma(\frac{3}{4}-\frac{1}{2}a) \sin \pi(\frac{1}{4} + \frac{1}{2}a)}{\sqrt{\pi}2^{1/2}a-1} y_2 = 2 \cos \pi(\frac{3}{4} + \frac{1}{2}a) \cdot Y_2 = U(a, x) - U(a, -x)$$

19.4.6

$$\sqrt{2\pi}U(-a, \pm ix) = \Gamma(\frac{1}{2}+a) \{ e^{-i\pi(1/2+a)}U(a, \pm x) + e^{i\pi(1/2+a)}U(a, \mp x) \}$$

19.4.7

$$\sqrt{2\pi}U(a, \pm ix) = \Gamma(\frac{1}{2}-a) \{ e^{-i\pi(1/2-a)}U(-a, \pm ix) + e^{i\pi(1/2-a)}U(-a, \mp ix) \}$$

19.5. Integral Representations

A full treatment is given in [19.11] section 4. Representations are given here for  $U(a, z)$  only; others may be derived by use of the relations given in 19.4.

19.5.1  $U(a, z) = \frac{\Gamma(\frac{1}{2}-a)}{2\pi i} e^{-iz^2} \int_{\alpha} e^{zs-1/2s^2} s^{a-1/2} ds$

19.5.2  $= \frac{\Gamma(\frac{1}{2}-a)}{2\pi i} e^{iz^2} \int_{\beta} e^{-iz^2(z+t)^{a-1/2}} dt$

where  $\alpha$  and  $\beta$  are the contours shown in Figures 19.1 and 19.2.

When  $a + 1/2$  is a positive integer these integrals become indeterminate; in this case

19.5.3  $U(a, z) = \frac{1}{\Gamma(\frac{1}{2}+a)} e^{-iz^2} \int_0^{\infty} e^{-zs-1/2s^2} s^{a-1/2} ds$

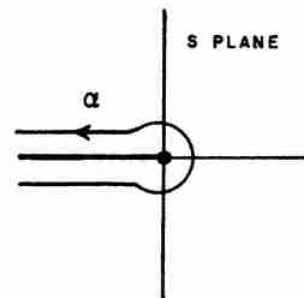

FIGURE 19.1  
- $\pi < \arg s < \pi$

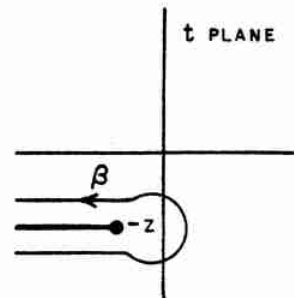

FIGURE 19.2  
- $\pi < \arg(z+t) < \pi$



19.5.4  $U(a, z) = \frac{1}{\sqrt{2\pi i}} e^{iz^2} \int_{\epsilon} e^{-zs + \frac{1}{2}s^2} s^{-a-\frac{1}{2}} ds$

19.5.5  $= \frac{e^{(a-\frac{1}{2})\pi i}}{\sqrt{2\pi i}} e^{iz^2} \int_{\epsilon_3} e^{zs + \frac{1}{2}s^2} s^{-a-\frac{1}{2}} ds$

19.5.6  $= \frac{e^{-(a-\frac{1}{2})\pi i}}{\sqrt{2\pi i}} e^{iz^2} \int_{\epsilon_4} e^{zs + \frac{1}{2}s^2} s^{-a-\frac{1}{2}} ds$

where  $\epsilon$ ,  $\epsilon_3$  and  $\epsilon_4$  are shown in Figures 19.3 and 19.4.

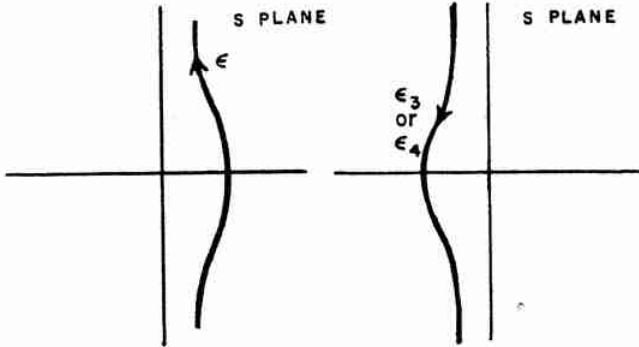

FIGURE 19.3  
 $-\frac{1}{2}\pi < \arg s < \frac{1}{2}\pi$

FIGURE 19.4  
On  $\epsilon_3$   $\frac{1}{2}\pi < \arg s < \frac{3}{2}\pi$   
On  $\epsilon_4$   $-\frac{3}{2}\pi < \arg s < -\frac{1}{2}\pi$

19.5.7  $U(a, z) = \frac{\Gamma(\frac{3}{4} - \frac{1}{2}a)}{2^{2a+\frac{1}{2}}\pi i} \int_{\zeta_1} e^{iz^2 t} (1+t)^{a-\frac{1}{2}} (1-t)^{-a-\frac{1}{2}} dt$

19.5.8  $= \frac{\Gamma(\frac{3}{4} - \frac{1}{2}a)}{2^{2a+\frac{1}{2}}\pi i} \int_{\eta_1} \frac{1}{2} z e^v (\frac{1}{4}z^2 + v)^{a-\frac{1}{2}} (\frac{1}{4}z^2 - v)^{-a-\frac{1}{2}} dv$

19.5.9  $U(a, z) = \frac{i\Gamma(\frac{1}{4} - \frac{1}{2}a)}{2^{2a+\frac{1}{2}}\pi} \int_{\eta_1} \frac{1}{2} z e^{-iz^2 t} (1+t)^{-a-\frac{1}{2}} (1-t)^{a-\frac{1}{2}} dt$

19.5.10  $= \frac{i\Gamma(\frac{1}{4} - \frac{1}{2}a)}{2^{2a+\frac{1}{2}}\pi} \int_{\eta_1} e^{-v} (\frac{1}{4}z^2 + v)^{-a-\frac{1}{2}} (\frac{1}{4}z^2 - v)^{a-\frac{1}{2}} dv$

The contour  $\zeta_1$  is such that  $(\frac{1}{4}z^2 + v)$  goes from  $\infty e^{-i\pi}$  to  $\infty e^{i\pi}$  while  $v = \frac{1}{4}z^2$  is not encircled;  $(\frac{1}{4}z^2 - v)^{-a-\frac{1}{2}}$  has its principal value except possibly in the immediate neighborhood of the branch-point when encirclement is being avoided. Likewise  $\eta_1$  is such that  $(\frac{1}{4}z^2 - v)$  goes from  $\infty e^{i\pi}$  to  $\infty e^{-i\pi}$  while encirclement of  $v = -\frac{1}{4}z^2$  is similarly avoided. The contours  $(\zeta_1)$  and  $(\eta_1)$  may be obtained from  $\zeta_1$  and  $\eta_1$  by use of the substitution  $v = \frac{1}{4}z^2 t$ .

The expressions 19.5.7 and 19.5.8 become indeterminate when  $a = \frac{3}{2}, \frac{7}{2}, \frac{11}{2}, \dots$ ; for these values

19.5.11  $U(a, z) = \frac{1}{\Gamma(\frac{3}{4} + \frac{1}{2}a)} z e^{-iz^2} \int_0^\infty e^{-s} s^{2a-1} (z^2 + 2s)^{-a-\frac{1}{2}} ds$

Again 19.5.9 and 19.5.10 become indeterminate when  $a = \frac{1}{2}, \frac{5}{2}, \frac{9}{2}, \dots$ ; for these values

19.5.12  $U(a, z) = \frac{1}{\Gamma(\frac{3}{4} + \frac{1}{2}a)} e^{-iz^2} \int_0^\infty e^{-s} s^{2a-1} (z^2 + 2s)^{-a-\frac{1}{2}} ds$

Barnes-Type Integrals

19.5.13  $U(a, z) = \frac{e^{-iz^2}}{2\pi i} z^{-a-\frac{1}{2}} \int_{-\infty-i}^{+\infty+i} \frac{\Gamma(s)\Gamma(\frac{1}{2}+a-2s)}{\Gamma(\frac{1}{2}+a)} (\sqrt{2}z)^{2s} ds$  ( $|\arg z| < \frac{3}{4}\pi$ )

where the contour separates the zeros of  $\Gamma(s)$  from those of  $\Gamma(a + \frac{1}{2} - 2s)$ . Similarly

19.5.14  $V(a, z) = \sqrt{\frac{2}{\pi}} \frac{e^{iz^2}}{2\pi i} z^{a-\frac{1}{2}} \int_{-\infty-i}^{+\infty+i} \frac{\Gamma(s)\Gamma(\frac{1}{2}-a-2s)}{\Gamma(\frac{1}{2}-a)} (\sqrt{2}z)^{2s} \cos s\pi ds$  ( $|\arg z| < \frac{1}{4}\pi$ )

19.6. Recurrence Relations

19.6.1  $U'(a, x) + \frac{1}{2}xU(a, x) + (a + \frac{1}{2})U(a+1, x) = 0$

19.6.2  $U'(a, x) - \frac{1}{2}xU(a, x) + U(a-1, x) = 0$

19.6.3  $2U'(a, x) + U(a-1, x) + (a + \frac{1}{2})U(a+1, x) = 0$

19.6.4  $xU(a, x) - U(a-1, x) + (a + \frac{1}{2})U(a+1, x) = 0$

These are also satisfied by  $\Gamma(\frac{1}{2}-a)V(a, x)$ .

19.6.5  $V'(a, x) - \frac{1}{2}xV(a, x) - (a - \frac{1}{2})V(a-1, x) = 0$

19.6.6  $V'(a, x) + \frac{1}{2}xV(a, x) - V(a+1, x) = 0$

19.6.7  $2V'(a, x) - V(a+1, x) - (a - \frac{1}{2})V(a-1, x) = 0$

19.6.8  $xV(a, x) - V(a+1, x) + (a - \frac{1}{2})V(a-1, x) = 0$

These are also satisfied by  $U(a, x)/\Gamma(\frac{1}{2}-a)$

19.6.9  $y'_1(a, x) + \frac{1}{2}xy_1(a, x) = (a + \frac{1}{2})y_2(a+1, x)$

19.6.10  $y'_1(a, x) - \frac{1}{2}xy_1(a, x) = (a - \frac{1}{2})y_2(a-1, x)$

19.6.11  $y_2'(a, x) + \frac{1}{2}xy_2(a, x) = y_1(a+1, x)$

19.6.12  $y_2'(a, x) - \frac{1}{2}xy_2(a, x) = y_1(a-1, x)$

**Asymptotic Expansions**

**19.7. Expressions in Terms of Airy Functions**

When  $a$  is large and negative, write, for  $0 \leq x < \infty$

$$x = 2\sqrt{|a|}\xi \quad t = (4|a|)^{\frac{1}{2}}\tau$$

**19.7.1**

$$\tau = -(\frac{2}{3}\vartheta_3)^{\frac{1}{2}}$$

$$\vartheta_3 = \frac{1}{2} \int_{\xi}^1 \sqrt{1-s^2} ds = \frac{1}{4} \arccos \xi - \frac{1}{4}\xi \sqrt{1-\xi^2} \quad (\xi \leq 1)$$

**19.7.2**

$$\tau = +(\frac{2}{3}\vartheta_2)^{\frac{1}{2}}$$

$$\vartheta_2 = \frac{1}{2} \int_1^{\xi} \sqrt{s^2-1} ds = \frac{1}{4}\xi \sqrt{\xi^2-1} - \frac{1}{4} \operatorname{arccosh} \xi \quad (\xi \geq 1)$$

Then for  $x \geq 0, a \rightarrow -\infty$

**19.7.3**

$$U(a, x) \sim 2^{-i-i^2a} \Gamma(\frac{1}{4}-\frac{1}{2}a) \left(\frac{t}{\xi^2-1}\right)^{\frac{1}{4}} \operatorname{Ai}(t)$$

**19.7.4**

$$\Gamma(\frac{1}{2}-a) V(a, x) \sim 2^{-i-i^2a} \Gamma(\frac{1}{4}-\frac{1}{2}a) \left(\frac{t}{\xi^2-1}\right)^{\frac{1}{4}} \operatorname{Bi}(t)$$

Table 19.3 gives  $\tau$  as a function of  $\xi$ .

See [19.5] for further developments.

**19.8. Expansions for  $x$  Large and  $a$  Moderate**

When  $x \gg |a|$

**19.8.1**

$$U(a, x) \sim e^{-i^2x^2} x^{-a-i} \left\{ 1 - \frac{(a+\frac{1}{2})(a+\frac{3}{2})}{2x^2} + \frac{(a+\frac{1}{2})(a+\frac{3}{2})(a+\frac{5}{2})(a+\frac{7}{2})}{2 \cdot 4x^4} - \dots \right\} \quad (x \rightarrow +\infty)$$

**19.8.2**

$$V(a, x) \sim \sqrt{\frac{2}{\pi}} e^{i^2x^2} x^{a-i} \left\{ 1 + \frac{(a-\frac{1}{2})(a-\frac{3}{2})}{2x^2} + \frac{(a-\frac{1}{2})(a-\frac{3}{2})(a-\frac{5}{2})(a-\frac{7}{2})}{2 \cdot 4x^4} + \dots \right\} \quad (x \rightarrow +\infty)$$

These expansions form the basis for the choice of standard solutions in 19.3. The former is valid for complex  $x$ , with  $|\arg x| < \frac{1}{2}\pi$ , in the complete

sense of Watson [19.6], although valid for a wider range of  $|\arg x|$  in Poincaré's sense; the second series is completely valid *only for  $x$  real and positive*.

**19.9. Expansions for  $a$  Large With  $x$  Moderate**

(i)  $a$  positive

When  $a \gg x^2$ , with  $p = \sqrt{a}$ , then

19.9.1  $U(a, x) = \frac{\sqrt{\pi}}{2^{i^2a+i} \Gamma(\frac{3}{4} + \frac{1}{2}a)} \exp(-px + v_1)$

19.9.2  $U(a, -x) = \frac{\sqrt{\pi}}{2^{i^2a+i} \Gamma(\frac{3}{4} + \frac{1}{2}a)} \exp(px + v_2)$

where

19.9.3 
$$v_1, v_2 \sim \mp \frac{\frac{2}{3}(\frac{1}{2}x)^3}{2p} - \frac{(\frac{1}{2}x)^2}{(2p)^2} \mp \frac{\frac{1}{2}x - \frac{2}{3}(\frac{1}{2}x)^5}{(2p)^3} + \frac{2(\frac{1}{2}x)^4}{(2p)^4} \pm \frac{(\frac{1}{8}a\frac{1}{2}x)^3 - \frac{4}{7}(\frac{1}{2}x)^7}{(2p)^5} + \dots \quad (a \rightarrow +\infty)$$

The upper sign gives the first function, and the lower sign the second function.

(ii)  $a$  negative

When  $-a \gg x^2$ , with  $p = \sqrt{-a}$ , then

**19.9.4**

$$U(a, x) + i\Gamma(\frac{1}{2}-a) \cdot V(a, x) = \frac{e^{i\tau(4+i^2a)} \Gamma(\frac{1}{4}-\frac{1}{2}a)}{2^{i^2a+i} \sqrt{\pi}} e^{ipx} \exp(v_r + iv_i)$$

where

**19.9.5**

$$v_r \sim + \frac{(\frac{1}{2}x)^2}{(2p)^2} + \frac{2(\frac{1}{2}x)^4}{(2p)^4} - \frac{9(\frac{1}{2}x)^2 - \frac{1}{8}(\frac{1}{2}x)^6}{(2p)^6} - \dots$$

$$v_i \sim - \frac{\frac{2}{3}(\frac{1}{2}x)^3}{2p} + \frac{\frac{1}{2}x + \frac{2}{3}(\frac{1}{2}x)^5}{(2p)^3} + \frac{\frac{1}{8}a(\frac{1}{2}x)^3 - \frac{4}{7}(\frac{1}{2}x)^7}{(2p)^5} - \dots \quad (a \rightarrow -\infty)$$

Further expansions of a similar type will be found in [19.11].

**19.10. Darwin's Expansions**

(i)  $a$  positive,  $x^2 + 4a$  large. Write

**19.10.1**

$$X = \sqrt{x^2 + 4a}$$

$$\theta = 4a\vartheta_1(x/2\sqrt{a}) = \frac{1}{2} \int_0^x X dx = \frac{1}{2} xX + a \ln \frac{x+X}{2\sqrt{a}}$$

$$= \frac{x}{4} \sqrt{x^2 + 4a} + a \operatorname{arcsinh} \frac{x}{2\sqrt{a}}$$

(see Table 19.3 for  $\vartheta_1$ ), then

$$19.10.2 \quad U(a, x) = \frac{(2\pi)^{1/4}}{\sqrt{\Gamma(\frac{1}{2}+a)}} \exp \{-\theta + v(a, x)\}$$

$$19.10.3 \quad U(a, -x) = \frac{(2\pi)^{1/4}}{\sqrt{\Gamma(\frac{1}{2}+a)}} \exp \{\theta + v(a, -x)\}$$

where

19.10.4

$$v(a, x) \sim -\frac{1}{2} \ln X + \sum_{s=1}^{\infty} (-1)^s d_{3s} / X^{3s} \quad (a > 0, x^2 + 4a \rightarrow +\infty)$$

and  $d_{3s}$  is given by 19.10.13.

(ii)  $a$  negative,  $x^2 + 4a$  large and positive. Write

$$19.10.5 \quad X = \sqrt{x^2 - 4|a|}$$

$$\theta = 4|a| \vartheta_2(x/2\sqrt{|a|}) = \frac{1}{2} \int_{2\sqrt{|a|}}^x X dx = \frac{1}{4} x X + a \ln \frac{x+X}{2\sqrt{|a|}}$$

$$= \frac{1}{4} x \sqrt{x^2 - 4|a|} + a \operatorname{arccosh} \frac{x}{2\sqrt{|a|}}$$

(see Table 19.3 for  $\vartheta_2$ ), then

$$19.10.6 \quad U(a, x) = \frac{\sqrt{\Gamma(\frac{1}{2}-a)}}{(2\pi)^{1/4}} \exp \{-\theta + v(a, x)\}$$

19.10.7

$$V(a, x) = \frac{2}{(2\pi)^{1/4} \sqrt{\Gamma(\frac{1}{2}-a)}} \exp \{\theta + v(a, -x)\}$$

where again

19.10.8

$$v(a, x) \sim -\frac{1}{2} \ln X + \sum_{s=1}^{\infty} (-1)^s d_{3s} / X^{3s} \quad (a < 0, x^2 + 4a \rightarrow +\infty)$$

and  $d_{3s}$  is given by 19.10.13.

(iii)  $a$  large and negative and  $x$  moderate. Write

$$19.10.9 \quad Y = \sqrt{4|a| - x^2}$$

$$\theta = 4|a| \vartheta_4(x/2\sqrt{|a|})$$

$$= \frac{1}{2} \int_0^x Y dx = \frac{1}{4} x Y + |a| \arcsin \frac{x}{2\sqrt{|a|}}$$

(see Table 19.3 for  $\vartheta_4 = \frac{1}{8}\pi - \vartheta_3$ ), then

19.10.10

$$U(a, x) = \frac{2\sqrt{\Gamma(\frac{1}{2}-a)}}{(2\pi)^{1/4}} e^{v_r} \cos \left\{ \frac{1}{4}\pi + \frac{1}{2}\pi a + \theta + v_i \right\}$$

19.10.11

$$V(a, x) = \frac{2}{(2\pi)^{1/4} \sqrt{\Gamma(\frac{1}{2}-a)}} e^{v_r} \sin \left\{ \frac{1}{4}\pi + \frac{1}{2}\pi a + \theta + v_i \right\}$$

where

$$19.10.12 \quad v_r \sim -\frac{1}{2} \ln Y - \frac{d_6}{Y^6} + \frac{d_{12}}{Y^{12}} - \dots$$

$$v_i \sim \frac{d_3}{Y^3} - \frac{d_9}{Y^9} + \dots \quad (x^2 + 4a \rightarrow -\infty)$$

In each case the coefficients  $d_s$  are given by

19.10.13

$$d_3 = \frac{1}{a} \left( \frac{x^3}{48} + \frac{1}{2} ax \right)$$

$$d_6 = \frac{3}{4} x^2 - 2a$$

$$d_9 = \frac{1}{a^3} \left( -\frac{7}{5760} x^9 - \frac{7}{320} ax^7 - \frac{49}{320} a^2 x^5 \right.$$

$$\left. + \frac{31}{12} a^3 x^3 - 19a^4 x \right)$$

$$d_{12} = \frac{153}{8} x^4 - 186ax^2 + 80a^2$$

See [19.11] for  $d_{15}, \dots, d_{24}$ , and [19.5] for an alternative form.

### 19.11. Modulus and Phase

When  $a$  is negative and  $|x| < 2\sqrt{|a|}$ , the functions  $U$  and  $V$  are oscillatory and it is sometimes convenient to write

$$19.11.1 \quad U(a, x) + i\Gamma(\frac{1}{2}-a)V(a, x) = F(a, x)e^{i\chi(a, x)}$$

$$19.11.2 \quad U'(a, x) + i\Gamma(\frac{1}{2}-a)V'(a, x) = -G(a, x)e^{i\psi(a, x)}$$

Then, when  $a < 0$  and  $|a| \gg x^2$ ,

19.11.3

$$F = \frac{\Gamma(\frac{1}{2}-\frac{1}{2}a)}{2^{3a+1}\sqrt{\pi}} e^{v_r}, \quad \chi = (\frac{1}{2}a + \frac{1}{4})\pi + px + v_i$$

where  $v_r, v_i$  are given by 19.9.5 and  $p = \sqrt{-a}$ .

Alternatively, with  $p = \sqrt{|a|}$ , and again  $-a \gg x^2$ ,

19.11.4

$$F \sim \frac{\Gamma(\frac{1}{2}-\frac{1}{2}a)}{2^{3a+1}\sqrt{\pi}} \left\{ 1 + \frac{x^2}{(4p)^2} + \frac{\frac{5}{8}x^4}{(4p)^4} + \frac{\frac{1}{2}x^6 - 144x^2}{(4p)^6} + \dots \right\}$$

$$19.11.5 \quad \chi \sim \left(\frac{1}{2}a + \frac{1}{4}\right)\pi + px \left\{ 1 - \frac{\frac{3}{2}x^2}{(4p)^2} - \frac{\frac{3}{2}x^4 - 16}{(4p)^4} - \frac{\frac{4}{3}x^6 - \frac{25}{3}x^2}{(4p)^6} \dots \right\}$$

$$19.11.6 \quad G \sim \frac{\Gamma(\frac{3}{4} - \frac{1}{2}a)}{2^{1/2}a - \frac{1}{2}\sqrt{\pi}} \left\{ 1 - \frac{x^2}{(4p)^2} - \frac{\frac{3}{2}x^4}{(4p)^4} - \frac{\frac{7}{2}x^6 - 176x^2}{(4p)^6} \dots \right\}$$

$$19.11.7 \quad \psi \sim \left(\frac{1}{2}a - \frac{1}{4}\right)\pi + px \left\{ 1 - \frac{\frac{3}{2}x^2}{(4p)^2} - \frac{\frac{3}{2}x^4 + 16}{(4p)^4} - \frac{\frac{4}{3}x^6 + \frac{25}{3}x^2}{(4p)^6} \dots \right\}$$

Again, when  $x^2 + 4a$  is large and negative, with  $Y = \sqrt{4|a| - x^2}$ , then

$$19.11.8 \quad F = \frac{2\sqrt{\Gamma(\frac{1}{2}-a)}}{(2\pi)^{1/2}} e^{\theta}, \quad \chi = \frac{1}{4}\pi + \frac{1}{2}\pi a + \theta + v_i$$

where  $\theta$ ,  $v_r$  and  $v_i$  are given by 19.10.9 and 19.10.12.

Another form is

$$19.11.9 \quad F \sim \frac{2\sqrt{\Gamma(\frac{1}{2}-a)}}{(2\pi)^{1/2}\sqrt{Y}} \left( 1 + \frac{3}{4Y^4} + \frac{5a}{Y^6} + \frac{621}{32Y^8} + \dots \right) \quad (x^2 + 4a \rightarrow -\infty)$$

$$19.11.10 \quad G \sim \frac{\sqrt{Y}\sqrt{\Gamma(\frac{1}{2}-a)}}{(2\pi)^{1/2}} \left( 1 - \frac{5}{4Y^4} - \frac{7a}{Y^6} - \frac{835}{32Y^8} - \dots \right) \quad (x^2 + 4a \rightarrow -\infty)$$

while  $\psi$  and  $\chi$  are connected by

$$19.11.11 \quad \psi - \chi \sim -\frac{1}{2}\pi - \frac{x}{Y^3} \left( 1 + \frac{47}{6Y^4} + \frac{214a}{3Y^6} + \frac{14483}{40Y^8} + \dots \right) \quad (x^2 + 4a \rightarrow -\infty)$$

### Connections With Other Functions

#### 19.12. Connection With Confluent Hypergeometric Functions (see chapter 13)

$$19.12.1 \quad U(a, \pm x) = \frac{\sqrt{\pi}2^{-1/2}x^{-1/2}}{\Gamma(\frac{3}{4} + \frac{1}{2}a)} M_{-1/2, -1/2}(\frac{1}{2}x^2) \mp \frac{\sqrt{\pi}2^{1/2}x^{-1/2}}{\Gamma(\frac{1}{4} + \frac{1}{2}a)} M_{-1/2, 1/2}(\frac{1}{2}x^2)$$

$$19.12.2 \quad U(a, x) = 2^{-1/2}x^{-1/2}W_{-1/2, -1/2}(\frac{1}{2}x^2)$$

#### 19.12.3

$$U(a, \pm x) = \frac{\sqrt{\pi}2^{-1/2}e^{-1/2x^2}}{\Gamma(\frac{3}{4} + \frac{1}{2}a)} M(\frac{1}{2}a + \frac{1}{4}, \frac{1}{2}, \frac{1}{2}x^2) \mp \frac{\sqrt{\pi}2^{1/2}xe^{-1/2x^2}}{\Gamma(\frac{1}{4} + \frac{1}{2}a)} M(\frac{1}{2}a + \frac{3}{4}, \frac{3}{2}, \frac{1}{2}x^2)$$

#### 19.12.4

$$U(a, x) = 2^{-1/2}e^{-1/2x^2}U(\frac{1}{2}a + \frac{1}{4}, \frac{1}{2}, \frac{1}{2}x^2) = 2^{-1/2}e^{-1/2x^2}U(\frac{1}{2}a + \frac{3}{4}, \frac{3}{2}, \frac{1}{2}x^2)$$

Expressions for  $V(a, x)$  may be obtained from these by use of 19.4.2.

#### 19.13. Connection With Hermite Polynomials and Functions

When  $n$  is a non-negative integer

#### 19.13.1

$$U(-n - \frac{1}{2}, x) = e^{-1/2x^2}He_n(x) = 2^{-1/2}e^{-1/2x^2}H_n(x/\sqrt{2})$$

#### 19.13.2

$$V(n + \frac{1}{2}, x) = \sqrt{2/\pi}e^{1/2x^2}He_n^*(x) = 2^{-1/2}e^{1/2x^2}H_n^*(x/\sqrt{2})$$

in which  $H_n(x)$  and  $He_n(x)$  are Hermite polynomials (see chapter 22) while

$$19.13.3 \quad He_n^*(x) = e^{-1/2x^2} \frac{d^n}{dx^n} e^{1/2x^2} = (-i)^n He_n(ix)$$

$$19.13.4 \quad H_n^*(x) = e^{-x^2} \frac{d^n}{dx^n} e^{x^2} = (-i)^n H_n(ix)$$

This gives one elementary solution to 19.1.2 whenever  $2a$  is an odd integer, positive or negative.

#### 19.14. Connection With Probability Integrals and Dawson's Integral (see chapter 7)

If, as in [19.10]

$$19.14.1 \quad Hh_{-1}(x) = e^{-1/2x^2}$$

#### 19.14.2

$$Hh_n(x) = \int_x^\infty Hh_{n-1}(t) dt = (1/n!) \int_x^\infty (t-x)^n e^{-1/2t^2} dt \quad (n \geq 0)$$

then

$$19.14.3 \quad U(n + \frac{1}{2}, x) = e^{1/2x^2} Hh_n(x) \quad (n \geq -1)$$

Correspondingly

$$19.14.4 \quad V(\frac{1}{2}, x) = \sqrt{2/\pi} e^{ix^2}$$

and

19.14.5

$$V(-n - \frac{1}{2}, x) = e^{-ix^2} \left\{ \int_0^x e^{-it^2} V(-n + \frac{1}{2}, t) dt - \frac{\sin \frac{1}{2}n\pi}{2^{1/2} \Gamma(\frac{1}{2}n + 1)} \right\} \quad (n \geq 0)$$

Here  $V(-\frac{1}{2}, x)$  is closely related to Dawson's integral

$$\int_0^x e^{t^2} dt$$

These relations give a second solution of 19.1.2 whenever  $2a$  is an odd integer, and a second solution is unobtainable from  $U(a, x)$  by reflection in the  $y$ -axis.

### 19.15. Explicit Formula in Terms of Bessel Functions When $2a$ Is an Integer

Write

$$19.15.1 \quad I_{-n} - I_n = (2/\pi) \sin n\pi \cdot K_n$$

$$19.15.2 \quad I_{-n} + I_n = \cos n\pi \cdot \mathcal{J}_n$$

where the argument of all modified Bessel functions is  $\frac{1}{2}x^2$ . Then

$$19.15.3 \quad U(1, x) = 2\pi^{-1} (\frac{1}{2}x)^{\frac{1}{2}} (-K_{\frac{1}{2}} + K_{\frac{3}{2}})$$

$$19.15.4 \quad U(2, x) = 2 \cdot \frac{2}{3}\pi^{-1} (\frac{1}{2}x)^{\frac{3}{2}} (2K_{\frac{3}{2}} - 3K_{\frac{5}{2}} + K_{\frac{7}{2}})$$

19.15.5

$$U(3, x) = 2 \cdot \frac{2}{3} \cdot \frac{2}{5}\pi^{-1} (\frac{1}{2}x)^{\frac{5}{2}} (-5K_{\frac{5}{2}} + 9K_{\frac{7}{2}} - 5K_{\frac{9}{2}} + K_{\frac{11}{2}})$$

$$19.15.6 \quad V(1, x) = \frac{1}{2} (\frac{1}{2}x)^{\frac{1}{2}} (\mathcal{J}_{\frac{1}{2}} - \mathcal{J}_{\frac{3}{2}})$$

$$19.15.7 \quad V(2, x) = \frac{1}{2} (\frac{1}{2}x)^{\frac{3}{2}} (2\mathcal{J}_{\frac{3}{2}} - 3\mathcal{J}_{\frac{5}{2}} + \mathcal{J}_{\frac{7}{2}})$$

$$19.15.8 \quad V(3, x) = \frac{1}{2} (\frac{1}{2}x)^{\frac{5}{2}} (5\mathcal{J}_{\frac{5}{2}} - 9\mathcal{J}_{\frac{7}{2}} + 5\mathcal{J}_{\frac{9}{2}} - \mathcal{J}_{\frac{11}{2}})$$

$$19.15.9 \quad U(0, x) = \pi^{-1} (\frac{1}{2}x)^{\frac{1}{2}} K_{\frac{1}{2}}$$

$$19.15.10 \quad U(-1, x) = \pi^{-1} (\frac{1}{2}x)^{\frac{1}{2}} (K_{\frac{1}{2}} + K_{\frac{3}{2}})$$

19.15.11

$$\dot{U}(-2, x) = \pi^{-1} (\frac{1}{2}x)^{\frac{3}{2}} (2K_{\frac{3}{2}} + 3K_{\frac{5}{2}} - K_{\frac{7}{2}})$$

19.15.12

$$U(-3, x) = \pi^{-1} (\frac{1}{2}x)^{\frac{5}{2}} (5K_{\frac{5}{2}} + 9K_{\frac{7}{2}} - 5K_{\frac{9}{2}} - K_{\frac{11}{2}})$$

$$19.15.13 \quad V(0, x) = \frac{1}{2} (\frac{1}{2}x)^{\frac{1}{2}} \mathcal{J}_{\frac{1}{2}}$$

$$19.15.14 \quad V(-1, x) = (\frac{1}{2}x)^{\frac{1}{2}} (\mathcal{J}_{\frac{1}{2}} + \mathcal{J}_{\frac{3}{2}})$$

$$19.15.15 \quad V(-2, x) = \frac{2}{3} (\frac{1}{2}x)^{\frac{3}{2}} (2\mathcal{J}_{\frac{3}{2}} + 3\mathcal{J}_{\frac{5}{2}} - \mathcal{J}_{\frac{7}{2}})$$

19.15.16

$$V(-3, x) = \frac{2}{3} \cdot \frac{2}{5} (\frac{1}{2}x)^{\frac{5}{2}} (5\mathcal{J}_{\frac{5}{2}} + 9\mathcal{J}_{\frac{7}{2}} - 5\mathcal{J}_{\frac{9}{2}} - \mathcal{J}_{\frac{11}{2}})$$

$$19.15.17 \quad U(-\frac{1}{2}, x) = \sqrt{2/\pi} (\frac{1}{2}x) K_{\frac{1}{2}}$$

$$19.15.18 \quad U(-\frac{3}{2}, x) = \sqrt{2/\pi} (\frac{1}{2}x)^2 2K_{\frac{3}{2}}$$

$$19.15.19 \quad U(-\frac{5}{2}, x) = \sqrt{2/\pi} (\frac{1}{2}x)^3 (5K_{\frac{5}{2}} - K_{\frac{7}{2}})$$

$$19.15.20 \quad V(\frac{1}{2}, x) = (\frac{1}{2}x) (I_{\frac{1}{2}} + I_{-\frac{1}{2}})$$

$$19.15.21 \quad V(\frac{3}{2}, x) = (\frac{1}{2}x)^2 (2I_{\frac{3}{2}} + 2I_{-\frac{3}{2}})$$

$$19.15.22 \quad V(\frac{5}{2}, x) = (\frac{1}{2}x)^3 (5I_{\frac{5}{2}} + 5I_{-\frac{5}{2}} - I_{\frac{7}{2}} - I_{-\frac{7}{2}})$$

$$\text{The Equation } \frac{d^2y}{dx^2} + \left(\frac{1}{4}x^2 - a\right)y = 0$$

### 19.16. Power Series in $x$

Even and odd solutions are given by 19.2.1 to 19.2.4 with  $-ia$  written for  $a$  and  $xe^{ix}$  for  $x$ ; the series involves complex quantities in which the imaginary part of the sum vanishes identically.

Alternatively,

19.16.1

$$y_1 = 1 + a \frac{x^2}{2!} + (a^2 - \frac{1}{2}) \frac{x^4}{4!} + (a^3 - \frac{1}{2}a) \frac{x^6}{6!} + (a^4 - 11a^2 + \frac{1}{4}) \frac{x^8}{8!} + (a^5 - 25a^3 + \frac{2}{4}a) \frac{x^{10}}{10!} + \dots$$

19.16.2

$$y_2 = x + a \frac{x^3}{3!} + (a^2 - \frac{3}{2}) \frac{x^5}{5!} + (a^3 - \frac{1}{2}a) \frac{x^7}{7!} + (a^4 - 17a^2 + \frac{9}{4}) \frac{x^9}{9!} + (a^5 - 35a^3 + \frac{3}{4}a) \frac{x^{11}}{11!} + \dots$$

in which non-zero coefficients  $a_n$  of  $x^n/n!$  are connected by

$$19.16.3 \quad a_{n+2} = a \cdot a_n - \frac{1}{4}n(n-1)a_{n-2}$$

### 19.17. Standard Solutions (see [19.4])

$$19.17.1 \quad W(a, \pm x) = \frac{(\cosh \pi a)^{\frac{1}{2}}}{2\sqrt{\pi}} (G_1 y_1 \mp \sqrt{2} G_3 y_2)$$

$$19.17.2 \quad = 2^{-3/4} \left( \sqrt{\frac{G_1}{G_3}} y_1 \mp \sqrt{\frac{2G_3}{G_1}} y_2 \right)$$

where

$$19.17.3 \quad G_1 = |\Gamma(\frac{1}{4} + \frac{1}{2}ia)| \quad G_3 = |\Gamma(\frac{3}{4} + \frac{1}{2}ia)|$$

At  $x=0$ ,

$$19.17.4 \quad W(a, 0) = \frac{1}{2^{\frac{1}{2}}} \left| \frac{\Gamma(\frac{1}{4} + \frac{1}{2}ia)}{\Gamma(\frac{3}{4} + \frac{1}{2}ia)} \right|^{\frac{1}{2}} = \frac{1}{2^{\frac{1}{2}}} \sqrt{\frac{G_1}{G_3}}$$

19.17.5

$$W'(a, 0) = -\frac{1}{2^{\frac{1}{2}}} \left| \frac{\Gamma(\frac{3}{4} + \frac{1}{2}ia)}{\Gamma(\frac{1}{4} + \frac{1}{2}ia)} \right|^{\frac{1}{2}} = -\frac{1}{2^{\frac{1}{2}}} \sqrt{\frac{G_3}{G_1}}$$

**Complex Solutions**

$$19.17.6 \quad E(a, x) = k^{-1}W(a, x) + ik^{\frac{1}{2}}W(a, -x)$$

$$19.17.7 \quad E^*(a, x) = k^{-1}W(a, x) - ik^{\frac{1}{2}}W(a, -x)$$

where

$$19.17.8 \quad k = \sqrt{1 + e^{2\pi a}} - e^{\pi a} \quad 1/k = \sqrt{1 + e^{2\pi a}} + e^{\pi a}$$

In terms of  $U(a, x)$  of 19.3,

$$19.17.9 \quad E(a, x) = \sqrt{2}e^{i\pi a + i\pi x + i\pi\phi_2} U(ia, xe^{-i\pi})$$

with

$$19.17.10 \quad \phi_2 = \arg \Gamma(\frac{1}{2} + ia)$$

where the branch is defined by  $\phi_2 = 0$  when  $a = 0$  and by continuity elsewhere.

Also

19.17.11

$$\sqrt{2\pi}U(ia, xe^{-i\pi}) = \Gamma(\frac{1}{2} - ia) \{ e^{i\pi a - i\pi x} U(-ia, xe^{i\pi}) + e^{-i\pi a + i\pi x} U(-ia, -xe^{i\pi}) \}$$

**19.18. Wronskian and Other Relations**

$$19.18.1 \quad W\{W(a, x), W(a, -x)\} = 1$$

$$19.18.2 \quad W\{E(a, x), E^*(a, x)\} = -2i$$

$$19.18.3 \quad \sqrt{1 + e^{2\pi a}} E(a, x) = e^{\pi a} E^*(a, x) + iE^*(a, -x)$$

$$19.18.4 \quad E^*(a, x) = e^{-i(\phi_2 + i\pi)} E(-a, ix)$$

19.18.5

$$\sqrt{\Gamma(\frac{1}{2} + ia)} E^*(a, x) = e^{-i\pi} \sqrt{\Gamma(\frac{1}{2} - ia)} E(-a, ix)$$

**19.19. Integral Representations**

These are covered for 19.1.3 as well as for 19.1.2 in 19.5 (general complex argument).

**Asymptotic Expansions**

**19.20. Expressions in Terms of Airy Functions**

When  $a$  is large and positive, write, for  $0 \leq x < \infty$

$$x = 2\sqrt{a}\xi \quad t = (4a)^{\frac{1}{2}}\tau$$

19.20.1

$$\tau = -(\frac{2}{3}\vartheta_3)^{\frac{1}{2}}$$

$$\vartheta_3 = \frac{1}{2} \int_{\xi}^1 \sqrt{1-s^2} ds = \frac{1}{4} \arccos \xi - \frac{1}{4}\xi \sqrt{1-\xi^2} \quad (\xi \leq 1)$$

19.20.2

$$\tau = +(\frac{2}{3}\vartheta_2)^{\frac{1}{2}}$$

$$\vartheta_2 = \frac{1}{2} \int_1^{\xi} \sqrt{s^2-1} ds = \frac{1}{4}\xi \sqrt{\xi^2-1} - \frac{1}{4} \operatorname{arccosh} \xi \quad (\xi \geq 1)$$

Then for  $x > 0, a \rightarrow +\infty$

19.20.3

$$W(a, x) \sim \sqrt{\pi}(4a)^{-\frac{1}{2}} e^{-i\pi a} \left(\frac{t}{\xi^2-1}\right)^{\frac{1}{2}} \operatorname{Bi}(-t)$$

19.20.4

$$W(a, -x) \sim 2\sqrt{\pi}(4a)^{-\frac{1}{2}} e^{i\pi a} \left(\frac{t}{\xi^2-1}\right)^{\frac{1}{2}} \operatorname{Ai}(-t)$$

Table 19.3 gives  $\tau$  as a function of  $\xi$ . See [19.5] for further developments.

**19.21. Expansions for  $x$  Large and  $a$  Moderate**

When  $x \gg |a|$ ,

19.21.1

$$E(a, x) = \sqrt{2/x} \exp \{ i(\frac{1}{2}x^2 - a \ln x + \frac{1}{2}\phi_2 + \frac{1}{4}\pi) \} s(a, x)$$

19.21.2

$$W(a, x) = \sqrt{2k/x} \{ s_1(a, x) \cos(\frac{1}{4}x^2 - a \ln x + \frac{1}{4}\pi + \frac{1}{2}\phi_2) - s_2(a, x) \sin(\frac{1}{4}x^2 - a \ln x + \frac{1}{4}\pi + \frac{1}{2}\phi_2) \}$$

19.21.3

$$W(a, -x) = \sqrt{2/kx} \{ s_1(a, x) \sin(\frac{1}{4}x^2 - a \ln x + \frac{1}{4}\pi + \frac{1}{2}\phi_2) + s_2(a, x) \cos(\frac{1}{4}x^2 - a \ln x + \frac{1}{4}\pi + \frac{1}{2}\phi_2) \}$$

where  $\phi_2$  is defined by 19.17.10 and

$$19.21.4 \quad s(a, x) = s_1(a, x) + i s_2(a, x)$$

19.21.5

$$s_1(a, x) \sim 1 + \frac{v_2}{1!2x^2} - \frac{u_4}{2!2^2x^4} - \frac{v_6}{3!2^3x^6} + \frac{u_8}{4!2^4x^8} + \dots$$

19.21.6

$$s_2(a, x) \sim -\frac{u_2}{1!2x^2} - \frac{v_4}{2!2^2x^4} + \frac{u_6}{3!2^3x^6} + \frac{v_8}{4!2^4x^8} - \dots$$

with

$$(x \rightarrow +\infty)$$

19.21.7  $u_r + iv_r = \Gamma(r + \frac{1}{2} + ia) / \Gamma(\frac{1}{2} + ia)$

or

19.21.8  $s(a, x) \sim \sum_{r=0}^{\infty} (-i)^r \frac{\Gamma(2r + \frac{1}{2} + ia)}{\Gamma(\frac{1}{2} + ia)} \frac{1}{2^r r! x^{2r}}$

19.22. Expansions for a Large With x Moderate

(i) a positive

When  $a \gg x^2$ , with  $p = \sqrt{a}$ , then

19.22.1  $W(a, x) = W(a, 0) \exp(-px + v_1)$

19.22.2  $W(a, -x) = W(a, 0) \exp(px + v_2)$

where  $W(a, 0)$  is given by 19.17.4, and

19.22.3

$$v_1, v_2 \sim \pm \frac{\frac{2}{3}(\frac{1}{2}x)^3}{2p} + \frac{(\frac{1}{2}x)^2}{(2p)^2} \pm \frac{\frac{1}{2}x + \frac{2}{3}(\frac{1}{2}x)^5}{(2p)^3} + \frac{2(\frac{1}{2}x)^4}{(2p)^4} \pm \frac{\frac{1}{3}(\frac{1}{2}x)^3 + \frac{4}{3}(\frac{1}{2}x)^7}{(2p)^5} + \dots$$

( $a \rightarrow +\infty$ )

The upper sign gives the first function, and the lower sign the second function.

(ii) a negative

When  $-a \gg x^2$ , with  $p = \sqrt{-a}$ , then

19.22.4

$$W(a, x) + iW(a, -x) = \sqrt{2}W(a, 0) \exp\{v_r + i(px + \frac{1}{2}\pi + v_i)\}$$

where  $W(a, 0)$  is given by 19.17.4, and

19.22.5

$$v_r \sim -\frac{(\frac{1}{2}x)^2}{(2p)^2} + \frac{2(\frac{1}{2}x)^4}{(2p)^4} - \frac{9(\frac{1}{2}x)^2 + \frac{1}{3}(\frac{1}{2}x)^6}{(2p)^6} + \dots$$

$$v_i \sim \frac{\frac{2}{3}(\frac{1}{2}x)^3}{2p} - \frac{\frac{1}{2}x + \frac{2}{3}(\frac{1}{2}x)^5}{(2p)^3} + \frac{\frac{1}{3}(\frac{1}{2}x)^3 + \frac{4}{3}(\frac{1}{2}x)^7}{(2p)^5} - \dots$$

( $a \rightarrow -\infty$ )

Further expansions of a similar type will be found in [19.3].

19.23. Darwin's Expansions

(i) a positive,  $x^2 - 4a \gg 0$

Write

19.23.1  $X = \sqrt{x^2 - 4a} \quad \theta = 4a\vartheta_2(x/2\sqrt{a}) = \frac{1}{2} \int_{2\sqrt{a}}^x X dx$

$$= \frac{1}{4}xX - a \ln \frac{x+X}{2\sqrt{a}}$$

$$= \frac{1}{4}x\sqrt{x^2 - 4a} - a \operatorname{arccosh} \frac{x}{2\sqrt{a}}$$

(see Table 19.3 for  $\vartheta_2$ ), then

19.23.2  $W(a, x) = \sqrt{2ke^{\vartheta_2}} \cos(\frac{1}{4}\pi + \theta + v_i)$

19.23.3  $W(a, -x) = \sqrt{2/ke^{\vartheta_2}} \sin(\frac{1}{4}\pi + \theta + v_i)$

where

19.23.4  $v_r \sim -\frac{1}{2} \ln X - \frac{d_6}{X^6} + \frac{d_{12}}{X^{12}} - \dots$

$$v_i \sim -\frac{d_3}{X^3} + \frac{d_9}{X^9} - \frac{d_{15}}{X^{15}} + \dots$$

( $x^2 - 4a \rightarrow \infty$ )

and  $d_{3r}$  is given by 19.23.12.

(ii) a positive,  $4a - x^2 \gg 0$

Write

19.23.5

$$Y = \sqrt{4a - x^2} \quad \theta = 4a\vartheta_4(x/2\sqrt{a})$$

$$= \frac{1}{2} \int_0^x Y dx = \frac{1}{4}xY + a \arcsin \frac{x}{2\sqrt{a}}$$

(see Table 19.3 for  $\vartheta_4 = \frac{1}{2}\pi - \vartheta_3$ ), then

19.23.6  $W(a, x) = \exp\{-\theta + v(a, x)\}$

19.23.7  $W(a, -x) = \exp\{\theta + v(a, -x)\}$

where

19.23.8

$$v(a, x) \sim -\frac{1}{2} \ln Y + \frac{d_3}{Y^3} + \frac{d_9}{Y^9} + \frac{d_9}{Y^9} + \dots$$

( $x^2 - 4a \rightarrow -\infty$ )

and  $d_{3r}$  is again given by 19.23.12.

(iii) a negative,  $x^2 - 4a \gg 0$

Write

19.23.9

$$X = \sqrt{x^2 + 4|a|} \quad \theta = 4|a|\vartheta_1(x/2\sqrt{|a|}) = \frac{1}{2} \int_0^x X dx$$

$$= \frac{1}{4}xX - a \ln \frac{x+X}{2\sqrt{|a|}}$$

$$= \frac{1}{4}x\sqrt{x^2 + 4|a|} - a \operatorname{arcsinh} \frac{x}{2\sqrt{|a|}}$$

(see Table 19.3 for  $\vartheta_1$ ) then

19.23.10  $W(a, x) = \sqrt{2ke^{\vartheta_1}} \cos(\frac{1}{4}\pi + \theta + v_i)$

19.23.11  $W(a, -x) = \sqrt{2/ke^{\vartheta_1}} \sin(\frac{1}{4}\pi + \theta + v_i)$

where  $v_r$  and  $v_i$  are again given by 19.23.4. In each case the coefficients  $d_{3r}$  are given by



19.23.12

$$d_3 = -\frac{1}{a} \left( \frac{x^3}{48} - \frac{1}{2}ax \right)$$

$$d_6 = \frac{3}{4}x^2 + 2a$$

$$d_9 = \frac{1}{a^3} \left( \frac{7}{5760}x^9 - \frac{7}{320}ax^7 + \frac{49}{320}a^2x^5 + \frac{31}{12}a^3x^3 + 19a^4x \right)$$

$$d_{12} = \frac{153}{8}x^4 + 186ax^2 + 80a^2$$

See [19.11] for  $d_{15}, \dots, d_{24}$ , and [19.5] for an alternative form.

19.24. Modulus and Phase

When  $a$  is positive, the function  $W(a, x)$  is oscillatory when  $x < -2\sqrt{a}$  and when  $x > 2\sqrt{a}$ ; when  $a$  is negative, the function is oscillatory for all  $x$ . In such cases it is sometimes convenient to write

19.24.1

$$k^{-1}W(a, x) + ik^1W(a, -x) = E(a, x) = Fe^{ix} \quad (x > 0)$$

19.24.2

$$k^{-1} \frac{dW(a, x)}{dx} + ik^1 \frac{dW(a, -x)}{dx} = E'(a, x) = -Ge^{ix} \quad (x > 0)$$

Then, when  $x^2 \gg |a|$ ,

19.24.3

$$F \sim \sqrt{\frac{2}{x}} \left( 1 + \frac{a}{x^2} + \frac{10a^2 - 3}{4x^4} + \frac{30a^3 - 47a}{4x^6} + \dots \right)$$

19.24.4

$$\chi \sim \frac{1}{2}x^2 - a \ln x + \frac{1}{2}\phi_2 + \frac{1}{2}\pi + \frac{4a^2 - 3}{8x^2} + \frac{4a^3 - 19a}{8x^4} + \dots$$

19.24.5

$$G \sim \sqrt{\frac{x}{2}} \left( 1 - \frac{a}{x^2} - \frac{6a^2 - 5}{4x^4} - \frac{14a^3 - 63a}{4x^6} - \dots \right)$$

19.24.6

$$\psi \sim \frac{1}{2}x^2 - a \ln x + \frac{1}{2}\phi_2 - \frac{1}{2}\pi + \frac{4a^2 + 5}{8x^2} + \frac{4a^3 + 29a}{8x^4} + \dots$$

where  $\phi_2$  is defined by 19.17.10.

When  $a < 0$ ,  $|a| \gg x^2$

19.24.7  $F \sim \sqrt{2}W(a, 0)e^{v_r}$

where  $v_r$  is given by 19.22.5 with  $p = \sqrt{-a}$ . Also

19.24.8

$$F \sim \frac{1}{\sqrt{p}} \left( 1 - \frac{x^2}{(4p)^2} + \frac{\frac{5}{2}x^4 + 8}{(4p)^4} - \frac{\frac{1}{2}x^6 + 152x^2}{(4p)^6} + \dots \right)$$

19.24.9

$$\chi \sim \frac{1}{4}\pi + px \left( 1 + \frac{\frac{2}{3}x^2}{(4p)^2} - \frac{\frac{2}{3}x^4 + 16}{(4p)^4} + \frac{\frac{4}{3}x^6 + \frac{2}{3}x^2}{(4p)^6} - \dots \right)$$

19.24.10

$$G \sim \sqrt{p} \left( 1 + \frac{x^2}{(4p)^2} - \frac{\frac{2}{3}x^4 + 8}{(4p)^4} + \frac{\frac{7}{3}x^6 + 168x^2}{(4p)^6} - \dots \right)$$

19.24.11

$$\psi \sim -\frac{1}{4}\pi + px \left( 1 + \frac{\frac{2}{3}x^2}{(4p)^2} - \frac{\frac{2}{3}x^4 - 16}{(4p)^4} + \frac{\frac{4}{3}x^6 - \frac{3}{3}x^2}{(4p)^6} - \dots \right)$$

Again, when  $a < 0$ ,  $x^2 - 4a \gg 0$ , with  $X = \sqrt{x^2 + 4|a|}$ , then

19.24.12  $F \sim \sqrt{2}e^{v_r} \quad \chi = \frac{1}{4}\pi + \theta + v_i$

where  $\theta$ ,  $v_r$ , and  $v_i$  are given by 19.23.4 and 19.23.9.

Another form also when  $a > 0$ ,  $x^2 - 4a \rightarrow \infty$  is

19.24.13

$$F \sim \sqrt{\frac{2}{X}} \left( 1 - \frac{3}{4X^4} - \frac{5a}{X^6} + \frac{621}{32X^8} + \frac{1371a}{4X^{10}} - \dots \right)$$

19.24.14

$$G \sim \sqrt{\frac{X}{2}} \left( 1 + \frac{5}{4X^4} + \frac{7a}{X^6} - \frac{835}{32X^8} - \frac{1729a}{4X^{10}} + \dots \right)$$

while  $\psi$  and  $\chi$  are connected by

19.24.15

$$\psi - \chi \sim -\frac{1}{2}\pi + \frac{x}{X^3} \left( 1 - \frac{47}{6X^4} - \frac{214a}{3X^6} + \frac{14483}{40X^8} + \dots \right)$$

19.25. Connections With Other Functions

Connection With Confluent Hypergeometric and Bessel Functions

19.25.1

$$W(a, \pm x) = 2^{-1} \left\{ \sqrt{\frac{G_1}{G_3}} H\left(-\frac{3}{2}, \frac{1}{2}a, \frac{1}{4}x^2\right) \pm \sqrt{\frac{2G_3}{G_1}} xH\left(-\frac{1}{4}, \frac{1}{2}a, \frac{1}{4}x^2\right) \right\}$$

where

19.25.2

$$H(m, n, x) = e^{-ix} {}_1F_1(m+1-in; 2m+2; 2ix)$$

19.25.3

$$= e^{-ix} M(m+1-in, 2m+2, 2ix)$$

19.25.4

$$W(0, \pm x) = 2^{-1} \sqrt{\pi x} \{ J_{-\frac{1}{2}}(\frac{1}{2}x^2) \pm J_{\frac{1}{2}}(\frac{1}{2}x^2) \} \quad (x \geq 0)$$

19.25.5

$$\frac{d}{dx} W(0, \pm x) = -2^{-\frac{1}{2}} x \sqrt{\pi x} \{ J_{\frac{1}{2}}(\frac{1}{2}x^2) \pm J_{-\frac{1}{2}}(\frac{1}{2}x^2) \} \quad (x \geq 0)$$

19.26. Zeros

Zeros of solutions  $U(a, x)$ ,  $V(a, x)$  of 19.1.2 occur only for  $|x| < 2\sqrt{-a}$  when  $a$  is negative. A single exceptional zero is possible, for any  $a$ , in the general solution; neither  $U(a, x)$  nor  $V(a, x)$  has such a zero for  $x > 0$ .

Approximations may be obtained by reverting the series for  $\psi$  (or  $\chi$  for zeros of derivatives) in 19.11, giving  $\psi$  (or  $\chi$ ) values that are multiples of  $\frac{1}{2}\pi$ , odd multiples for  $U(a, x)$ , even multiples for  $V(a, x)$ . Writing

$$\alpha = (\frac{1}{2}r - \frac{1}{2}a - \frac{1}{4})\pi$$

as an approximation to a zero of the function, or

$$\beta = (\frac{1}{2}r - \frac{1}{2}a + \frac{1}{4})\pi$$

as an approximation to a zero of the derivative, we obtain for the corresponding zero  $c$  or  $c'$ , with  $-a = p^2$  the expressions

$$19.26.1 \quad c \approx \frac{\alpha}{p} + \frac{2\alpha^3 - 3\alpha}{48p^5} + \frac{52\alpha^5 - 240\alpha^3 + 315\alpha}{7680p^9} + \dots$$

$$19.26.2 \quad c' \approx \frac{\beta}{p} + \frac{2\beta^3 + 3\beta}{48p^5} + \frac{52\beta^5 + 280\beta^3 - 285\beta}{7680p^9} + \dots$$

These expansions, however, are of little value in the neighborhood of the turning point  $x = 2\sqrt{-a}$ . Here first approximations may be obtained by use of the formulas of 19.7. If  $a_n$  (negative) is a zero of  $\text{Ai}(t)$ , the corresponding zero  $c$  of  $U(a, x)$  is obtained approximately by solving

19.26.3

$$\vartheta_3 = \frac{1}{4} \{ \arccos \xi - \xi \sqrt{1 - \xi^2} \} = \frac{(-a_n)^{\frac{1}{2}}}{6|a|} \quad c = 2\sqrt{|a|}\xi \quad (a \ll 0)$$

This may be done by inverse use of Table 19.3. For a zero of  $V(a, x)$ ,  $a_n$  must be replaced by  $b_n$ , a zero of  $\text{Bi}(t)$ . For further developments see [19.5].

Zeros of solutions  $W(a, x)$ ,  $W(a, -x)$  of 19.1.3 occur for  $|x| > 2\sqrt{a}$  when  $a$  is positive; the general solution may, however, have a single zero between  $-2\sqrt{a}$  and  $+2\sqrt{a}$ . If  $a$  is negative, zeros are unrestricted in range.

Approximations may be obtained by reverting the series for  $\psi$  (or  $\chi$ ) in 19.24. With  $-a = p^2$ ,  $\alpha = (\frac{1}{2}r - \frac{1}{2})\pi$ ,  $\beta = (\frac{1}{2}r + \frac{1}{2})\pi$ ,  $r \geq 0$  being an odd

integer for  $W(a, x)$  or its derivative, or an even integer for  $W(a, -x)$  or its derivative, the zeros  $\pm c$ ,  $\pm c'$  have expansions

$$19.26.4 \quad c \approx \frac{\alpha}{p} - \frac{2\alpha^3 - 3\alpha}{48p^5} + \frac{52\alpha^5 - 240\alpha^3 + 315\alpha}{7680p^9} + \dots$$

$$19.26.5 \quad c' \approx \frac{\beta}{p} - \frac{2\beta^3 + 3\beta}{48p^5} + \frac{52\beta^5 + 280\beta^3 - 285\beta}{7680p^9} + \dots$$

When  $x$  is large and  $a$  moderate, we may solve inversely the series 19.24.4 or 19.24.6 with  $\alpha = \frac{1}{2}(r\pi - \frac{1}{2}\pi - \phi_2)$ ,  $\beta = \frac{1}{2}(r\pi + \frac{1}{2}\pi - \phi_2)$ ,  $r$  odd or even as above; the presence of the logarithm makes it inconvenient to revert formally.

The expansions 19.26.4 and 19.26.5 fail when  $x$  is in the neighborhood of  $2\sqrt{|a|}$ . When  $a$  is positive, a zero  $c$  of  $W(a, -x)$  is obtained approximately by solving

19.26.6

$$\vartheta_2 = \frac{1}{4} \{ \xi \sqrt{\xi^2 - 1} - \text{arccosh } \xi \} = \frac{(-a_n)^{\frac{1}{2}}}{6a} \quad c = 2\sqrt{a}\xi \quad (a \gg 0)$$

with the aid of Table 19.3. For a zero of  $W(a, x)$  we replace  $a_n$  by  $b_n$ . When  $a$  is negative we solve, again with the aid of Table 19.3,

19.26.7

$$\vartheta_1 = \frac{1}{4} \{ \xi \sqrt{\xi^2 + 1} + \text{arcsinh } \xi \} = \frac{(n - \frac{1}{4})\pi}{4|a|} \quad c = 2\sqrt{|a|}\xi \quad (-a \gg 0)$$

where  $n = 1, 2, 3, \dots$  for an approximate zero of  $W(a, -x)$ , and  $n = \frac{1}{2}, \frac{3}{2}, \frac{5}{2}, \dots$  for an approximate zero of  $W(a, x)$ . Further developments are given in [19.5].

Any of the approximations to zeros obtained above may readily be improved as follows:

Let  $c$  be a zero of  $y$ , and  $c'$  a zero of  $y'$ , where  $y$  is a solution of

$$19.26.8 \quad y'' - Iy = 0$$

Here  $I = a \pm \frac{1}{2}x^2$ ,  $I' = \pm \frac{1}{2}x$ ,  $I'' = \pm \frac{1}{2}$ ; the method is general and the following formulae may be used whenever  $I''' = 0$ . Then if  $\gamma, \gamma'$  are approximations to the zeros  $c, c'$  and

$$19.26.9 \quad u = y(\gamma)/y'(\gamma) \quad v = y'(\gamma')/I^2y(\gamma')$$

with  $I \equiv I(\gamma)$  or  $I \equiv I(\gamma')$  respectively, then

19.26.10

$$c \sim \gamma - u - \frac{1}{8} I u^3 + \frac{1}{12} I' u^4 - (\frac{1}{80} I'' + \frac{1}{8} I^2) u^5 + \frac{1}{80} I I' u^6 + \dots$$

19.26.11

$$y'(c) \sim y'(\gamma) \{ 1 - \frac{1}{2} I u^2 + \frac{1}{8} I' u^3 - (\frac{1}{24} I'' + \frac{1}{8} I^2) u^4 + \frac{7}{80} I I' u^5 + \dots \}$$

19.26.12

$$c' \sim \gamma' - I v - \frac{1}{2} I I' v^2 + (\frac{1}{8} I^2 I'' - \frac{1}{2} I I'^2 - \frac{1}{8} I^4) v^3 + (\frac{5}{12} I^2 I' I'' - \frac{5}{8} I I'^3 - \frac{5}{12} I^4 I') v^4 + \dots$$

19.26.13

$$y(c') \sim y(\gamma') \{ 1 - \frac{1}{2} I^3 v^2 - \frac{1}{8} I^3 I' v^3 - (\frac{1}{8} I^3 I'^2 - \frac{1}{24} I^4 I'' + \frac{1}{8} I^6) v^4 + \dots \}$$

The process can be repeated, if necessary, using as many terms at any stage as seems convenient.

Note the relations, holding at zeros,

19.26.14  $U'(a, c) = -\sqrt{2/\pi} V(a, c)$

19.26.15  $V'(a, c') = \sqrt{2/\pi} U(a, c')$

19.26.16  $W'(a, c) = -1/W(a, -c)$

19.26.17

$$W(a, c') = 1 / \left\{ \frac{d}{dx} W(a, -x) \right\}_{x=c'} = -1/W'(a, -c')$$

19.27. Bessel Functions of Order  $\pm \frac{1}{4}, \pm \frac{3}{4}$  as Parabolic Cylinder Functions

Most applications of these functions refer to cases where parabolic cylinder functions would be more appropriate. We have

19.27.1  $J_{\pm 1}(\frac{1}{4}x^2) = \frac{2^{\pm 1}}{\sqrt{\pi x}} \{ W(0, -x) \mp W(0, x) \}$

19.27.2  $J_{\pm 1}(\frac{1}{4}x^2) = \frac{-2^{\pm 1}}{x\sqrt{\pi x}} \{ W(0, x) \pm W(0, -x) \}$

Functions of other orders may be obtained by use of the recurrence relation 10.1.22, which here becomes

19.27.3  $\frac{1}{4}x^2 J_{\nu+1}(\frac{1}{4}x^2) - 2\nu J_{\nu}(\frac{1}{4}x^2) + \frac{1}{4}x^2 J_{\nu-1}(\frac{1}{4}x^2) = 0$

Again

19.27.4  $I_{-1}(\frac{1}{4}x^2) + I_1(\frac{1}{4}x^2) = \frac{2}{\sqrt{x}} V(0, x)$

19.27.5

$$\frac{\sqrt{2}}{\pi} K_1(\frac{1}{4}x^2) = I_{-1}(\frac{1}{4}x^2) - I_1(\frac{1}{4}x^2) = \frac{2}{\sqrt{\pi x}} U(0, x)$$

19.27.6  $I_{-1}(\frac{1}{4}x^2) + I_1(\frac{1}{4}x^2) = -\frac{4}{x\sqrt{x}} \frac{d}{dx} V(0, x)$

19.27.7

$$\begin{aligned} \frac{\sqrt{2}}{\pi} K_1(\frac{1}{4}x^2) &= I_{-1}(\frac{1}{4}x^2) - I_1(\frac{1}{4}x^2) \\ &= -\frac{4}{x\sqrt{\pi x}} \frac{d}{dx} U(0, x) \end{aligned}$$

As before, Bessel functions of other orders may be obtained by use of the recurrence relation 10.2.23, which here becomes

19.27.8  $\frac{1}{4}x^2 I_{\nu+1}(\frac{1}{4}x^2) + 2\nu I_{\nu}(\frac{1}{4}x^2) - \frac{1}{4}x^2 I_{\nu-1}(\frac{1}{4}x^2) = 0$

19.27.9  $\frac{1}{4}x^2 K_{\nu+1}(\frac{1}{4}x^2) - 2\nu K_{\nu}(\frac{1}{4}x^2) - \frac{1}{4}x^2 K_{\nu-1}(\frac{1}{4}x^2) = 0$

Numerical Methods

19.28. Use and Extension of the Tables

For  $U(a, x), V(a, x)$  and  $W(a, x)$ , interpolation  $x$ -wise may be carried out to 5-figure accuracy almost everywhere by using 5-point or 6-point Lagrangian interpolation. For  $|a| \leq 1$ , comparable accuracy  $a$ -wise may be obtained with 5- or 6-point interpolation.

For  $|a| > 1$ ,  $U(a, x)$  and  $V(a, x)$  may be obtained by use of recurrence relations from two values, possibly obtained by interpolation, with  $|a| \leq 1$ ; such a procedure is not available for  $W(a, \pm x)$ ,  $|a| > 1$ .

In cases where straightforward use of the  $a$ -wise recurrence relation results in loss of accuracy by cancellation of leading digits, it may be worth while to remark that greater accuracy is usually attainable by use of the recurrence relation in the

reverse direction, from arbitrary starting values (often 1 and 0) for two values of  $a$  somewhat beyond the last value desired. This is because the recurrence relation is a second order homogeneous linear difference equation, and has two independent solutions. Loss of accuracy by cancellation occurs when the solution desired is diminishing as  $a$  varies, while the companion solution is increasing. By reversing the direction of progress in  $a$ , the roles of the two solutions are interchanged, and the contribution of the desired solution now increases, while the unwanted solution diminishes to the point of negligibility. By starting sufficiently beyond the last value of  $a$  for which the function is desired, we can ensure that the unwanted solution is negligible but, because the starting values were arbitrary, we have an un-

known multiple of the solution desired. The computation is then carried back until a value of  $a$  with  $|a| \leq 1$  is reached, when the precise multiple that we have of the desired solution may be determined and hence removed throughout. Compare also 9.12, Example 1.

**Example 1.** Evaluate  $U(a, 5)$  for  $a=5, 6, 7, \dots$ , using 19.6.4.

$$(a + \frac{1}{2})U(a+1, x) + xU(a, x) - U(a-1, x) = 0$$

| $a$ | Forward Recurrence | Backward Recurrence | Final Values  |
|-----|--------------------|---------------------|---------------|
| 3   | (-6) 5.2847*       | (12) 1.59035        | (-6) 5.2847** |
| 4   | (-7) 9.172*        | (11) 2.76028        | (-7) 9.1724   |
| 5   | (-7) 1.5527        | (10) 4.67131        | (-7) 1.55227  |
| 6   | (-8) 2.5609        | (9) 7.72041         | (-8) 2.5655   |
| 7   | (-9) 4.1885        | (9) 1.24785         | (-9) 4.1466   |
| 8   | (-10) 6.2220       | (8) 1.97488         | (-10) 6.5625  |
| 9   | (-10) +1.2676      | (7) 3.06369         | (-10) 1.01806 |
| 10  | (-11) -0.1221      | (6) 4.66352         | (-11) 1.5497  |
| 11  | (-11) +1.2654      | (0) 697082          | (-12) 2.3164  |
| 12  | (-12) -5.6079      | 102444              | (-13) 3.404   |
| 13  | (-12) +3.2555      | 14789               | (-14) 4.91    |
| 14  |                    | 2111                | (-15) 7.01    |
| 15  |                    | 292                 | (-16) 9.7     |
| 16  |                    | 42                  |               |
| 17  |                    | 5                   |               |
| 18  |                    | 1+                  |               |
| 19  |                    | 0+                  |               |

\*From tables. +Starting values.

\*\*This value was used to obtain the constant multiplier  $\frac{d}{k^*} = \frac{(-6)5.2847}{(12)1.59035} = (-18)3.32298$  for converting the previous column into this one.

The second column shows forward recurrence starting with values at  $a=3, 4$  from Table 19.1. Backward recurrence starts with values 0 and 1 at  $a=19$  and 18, containing a multiple  $kU(a, 5)$  and a subsequently negligible multiple of the other solution  $\Gamma(\frac{1}{2}-a)V(a, 5)$ . Rounding errors convert  $kU(a, x)$  into  $k^*U(a, x)$  without affecting the values in the last column. The value of  $1/k^*$  is identified from the known value of  $U(3, 5)$ , and used to obtain the final column by multiplying throughout by  $1/k^*$ . The improvement in  $U(5, 5)$  is evident by comparison with Table 19.1.

*Derivatives.* These are not tabulated here. Since the functions  $U(a, x)$ ,  $V(a, x)$  and  $W(a, x)$  satisfy differential equations, values of derivatives are often required.

For all these functions the equation is second order with first derivative absent, so that *second derivatives* may be readily obtained from function values by use of the differential equation.

*First derivatives* can be obtained for  $U(a, x)$  and  $V(a, x)$  by applying the appropriate recurrence

relations 19.6.1-2. If less accuracy is needed they can be found by use of mean central differences of  $U(a, x)$ ,  $V(a, x)$  and also of  $W(a, x)$  with the formula

$$hu' = h \frac{du}{dx} = \mu\delta u - \frac{1}{6}\mu\delta^3 u + \frac{1}{30}\mu\delta^5 u - \dots$$

using  $h=.1$ ; this usually gives a 3- or 4-figure value of  $du/dx$ .

If greater accuracy is needed for  $dW(a, x)/dx$  it may be obtained by evaluating  $d^2W/dx^2$  with the help of the differential equation satisfied by  $W$  and integrating this second derivative numerically. This requires one accurate value of  $dW/dx$  to start off the integration; we describe two methods for obtaining this, both making use of the difference between two fairly widely separated values of  $W$ , for example, separated by 5 or 10 tabular intervals.

(i) Write  $f_r, f'_r, f''_r$  for  $W(a, x_0+rh)$  and its first two derivatives, then  $f'_0$  may be found from

$$hf'_0 = \frac{1}{2n} (f_n - f_{-n}) - \frac{h^2}{2n} \sum_1^{n-1} (n-r)(f''_r - f''_{-r}) - \frac{h^2}{2n} \left\{ \frac{1}{12} - \frac{1}{240} \delta^2 + \frac{31}{80480} \delta^4 - \dots \right\} (f''_n - f''_{-n}) - h^2 \left\{ \frac{1}{12} \mu \delta - \frac{11}{720} \mu \delta^3 + \frac{191}{80480} \mu \delta^5 - \dots \right\} f''_0$$

(ii) Consider a solution  $y$  of the differential equation for  $W(a, x)$ , namely  $y'' = (-\frac{1}{2}x^2 + a)y$ . If we are given values  $y$  and  $y'$  at a particular  $x=x_0$  and write  $T_n = H^n y^{(n)}/n!$ ,  $T_{-1} = T_{-2} = 0$ , then we may compute  $T_2, T_3, T_4, \dots$  in succession by use of the recurrence relation obtained from the differential equation,

$$T_{n+2} = \frac{H^2}{(n+1)(n+2)} [(-\frac{1}{2}x_0^2 + a)T_n - \frac{1}{2}Hx_0T_{n-1} - \frac{1}{2}H^2T_{n-2}]$$

These are computed, to a fixed number of decimals until they become negligible, thus giving

$$y(x_0 \pm H) = T_0 \pm T_1 + T_2 \pm T_3 + \dots$$

This may be applied, with  $H=rh$ ,  $h$  being the tabular interval, and  $r$  a small integer, say  $r=5$ , to the solutions  $y=y_1, y=y_2$  having

$$\begin{aligned} y_1(x_0) &= W(a, x_0) & y'_1(x_0) &= W^{*'}(a, x_0) \\ y_2(x_0) &= 0 & y'_2(x_0) &= 1 \end{aligned}$$

in which  $W^{*'}(a, x_0)$  is an approximation to  $W'(a, x_0)$ , not necessarily a good one; it may be



obtained from differences, for example. We thus obtain  $y_1(x_0 \pm H)$  and  $y_2(x_0 \pm H)$ .

Now suppose

$$W'(a, x_0) = W^{*'}(a, x_0) + \lambda$$

then, for all  $x$

$$W(a, x) = y_1(x) + \lambda y_2(x)$$

and in particular

$$W(a, x_0 \pm H) = y_1(x_0 \pm H) + \lambda y_2(x_0 \pm H)$$

The values of  $W(a, x_0 \pm H)$  may be read from the tables and two independent estimates of  $\lambda$  obtained, whence

$$W'(a, x_0) = W^{*'}(a, x_0) + \lambda$$

to a suitable accuracy.

**Example 2.** Evaluate  $W'(-3, 1)$  using  $r=5$ . From **Table 19.2**

$$W(-3, .5) = -.05857 \quad W(-3, 1) = -.61113$$

$$W(-3, 1.5) = -.69502$$

(i) Using the first method

| $x$ | $W(-3, x)$ | $W''(-3, x)$ | $\delta$ | $\delta^2$ | $\delta^3$ |
|-----|------------|--------------|----------|------------|------------|
| 0.4 | +0.07298   | -0.22186     |          |            |            |
| 0.5 | -.05857    | +.17937      |          | +131       |            |
| 0.6 | -.18832    | .58191       |          |            |            |
| 0.7 | -.31226    | .97503       |          |            |            |
| 0.8 | -.42646    | 1.34761      |          |            |            |
| 0.9 | -.52722    | 1.68842      | 34081    |            |            |
| 1.0 | -.61113    | 1.98617      | 29775    |            | -1095      |
| 1.1 | -.67522    | 2.22991      | 24374    |            | -1032      |
| 1.2 | -.71706    | 2.40932      | 17941    |            |            |
| 1.3 | -.73488    | 2.51513      |          |            |            |
| 1.4 | -.72761    | 2.53936      |          |            |            |
| 1.5 | -.69502    | 2.47601      |          |            | -9129      |
| 1.6 | -.63774    | 2.32137      |          |            |            |

The fifth decimal in  $W''(-3, x)$  is only a guard figure which is hardly needed. Only the differences needed have been computed.

Then

$$\frac{1}{10}W'(-3, 1)$$

$$= \frac{1}{10}(-.69502 + .05857) - \frac{1}{1000}(10.38874)$$

$$- \frac{1}{1000} \left\{ \frac{1}{12}(2.29664) - \frac{1}{240}(-.09260) \right\}$$

$$- \frac{1}{100} \left\{ \frac{1}{24}(.54149) - \frac{11}{1440}(-.02127) \right\}$$

$$= -.0636450 - .0103887 - .0001918 - .0002272$$

$$= -.0744527$$

Thus  $W'(-3, 1) = -.74453$ . This might have an error up to about  $1\frac{1}{2}$  units in the last figure but is, in fact, correct to 5 decimals.

(ii) Using the second method, with

$$y_1(1) = W(-3, 1) = -.61113 \quad \text{to 5 decimals}$$

$$y_1'(1) = -.745 \quad \text{to about 3 decimals}$$

the following values result, with  $H=.5$ ,

|          | $y_1$     | $y_2$  | $W(-3, x) = y_1 + \lambda y_2$ |
|----------|-----------|--------|--------------------------------|
| $T_0$    | -.61113   | .0000  | At $x=1.5$                     |
| $T_1$    | -.37250   | +.5000 | $x-.695223 + .4323\lambda$     |
|          |           |        | $= -.69502$                    |
| $T_2$    | +.24827 2 | .0000  | $\lambda = .000203/.4323$      |
| $T_3$    | + 5680 9  | - 677  | $= .000470$                    |
| $T_4$    | - 1407 4  | - 26   | So $W'(-3, 1)$                 |
|          |           |        | $= -.745 + \lambda$            |
|          |           |        | $= -.744530$                   |
| $T_5$    | - 279 3   | + 24   | At $x=.5$                      |
| $T_6$    | + 13 4    | + 2    | $-.058363 - .4371\lambda$      |
|          |           |        | $= -.05857$                    |
| $T_7$    | + 5 4     |        | $\lambda = .000207/.4371$      |
| $T_8$    | + 5       |        | $= .000474$                    |
| $y(1.5)$ | -.695223  | +.4323 | So $W'(-3, 1)$                 |
| $y(.5)$  | -.058363  | -.4371 | $= -.745 + \lambda$            |
|          |           |        | $= -.744526$                   |

Thus  $W'(-3, 1) = -.74453$  which is correct to 5 decimals.

**Example 3.** Evaluate the positive zero of  $U(-3, x)$ .

We use 19.7.3 to obtain a first approximation, see 19.26.3. The appropriate zero of  $Ai(t)$  is at

$$t = (4|a|)^{1/2} \tau = -2.338$$

whence

$$\tau = -(2.338) \times (12)^{-1/2} = -.4461$$

Hence, from **Table 19.3**,  $\xi = .3990$  and the approximate zero is  $x = 2\sqrt{|a|}\xi = 1.382$ .

We improve this by using 19.26.10, but take, for convenience,  $x=1.4$  as an approximation, so that the value of  $U$  can be read directly from the tables.  $U'$  can be obtained as in the section following

**Example 1.**

We find

$$U(-3, 1.4) = .02627 \quad U'(-3, 1.4) = 2.0637$$

Then 19.26.9 gives

$$u = U/U' = .012730 \quad I = -2.51$$

$$I' = .7 \quad I'' = .5$$

and

$$c=1.4-.012730+.000002=1.38727$$

which is correct to 5 decimals, while 19.26.11 gives

$$y'(c)=2.0637(1+.000203)=2.0641$$

compared with the correct value 2.06416.

### References

#### Texts

- [19.1] H. Buchholz, Die konfluente hypergeometrische Funktion (Springer-Verlag, Berlin, Germany, 1953).
- [19.2] C. G. Darwin, On Weber's function, *Quart. J. Mech. Appl. Math.* **2**, 311-320 (1949).
- [19.3] A. Erdélyi et al., Higher transcendental functions, vol. 2 (McGraw-Hill Book Co., Inc., New York, N.Y., 1953).
- [19.4] J. C. P. Miller, On the choice of standard solutions to Weber's equation, *Proc. Cambridge Philos. Soc.* **48**, 428-435 (1952).
- [19.5] F. W. J. Olver, Uniform asymptotic expansions for Weber parabolic cylinder functions of large order, *J. Research NBS* **63B**, 2, 131-169 (1959), RP63B2-14.
- [19.6] G. N. Watson, A theory of asymptotic series, *Philos. Trans. Roy. Soc. London*, **A 211**, 279-313 (1911).
- [19.7] H. F. Weber, Ueber die Integration der partiellen Differential-gleichung:  $\partial^2 u / \partial x^2 + \partial^2 u / \partial y^2 + k^2 u = 0$ , *Math. Ann.* **1**, 1-36 (1869).
- [19.8] E. T. Whittaker, On the functions associated with the parabolic cylinder in harmonic analysis, *Proc. London Math. Soc.* **35**, 417-427 (1903).
- [19.9] E. T. Whittaker and G. N. Watson, A course of modern analysis, 4th ed. (Cambridge Univ. Press, Cambridge, England, 1952).

#### Tables

- [19.10] British Association for the Advancement of Science, Mathematical Tables, vol. I, Circular and hyperbolic functions, exponential, sine and cosine integrals, factorial (gamma) and derived functions, integrals of probability integral, 1st ed. (British Association, London, England, 1931; Cambridge Univ. Press, Cambridge, England, 2d ed., 1946, 3d ed., 1951).
- [19.11] National Physical Laboratory, Tables of Weber parabolic cylinder functions. Computed by Scientific Computing Service Ltd. Mathematical Introduction by J. C. P. Miller. (Her Majesty's Stationery Office, London, England, 1955).
- [19.12] National Physical Laboratory Mathematical Tables, vol. 4, Tables of Weber parabolic cylinder functions and other functions for large arguments, by L. Fox (Her Majesty's Stationery Office, London, England, 1960).

# 20. Mathieu Functions

GERTRUDE BLANCH<sup>1</sup>

## Contents

|   | Page |
|---|------|
| <b>Mathematical Properties</b> . . . . .  | 722  |
| 20.1. Mathieu's Equation . . . . .  | 722  |
| 20.2. Determination of Characteristic Values . . . . .  | 722  |
| 20.3. Floquet's Theorem and Its Consequences . . . . .  | 727  |
| 20.4. Other Solutions of Mathieu's Equation . . . . .   | 730  |
| 20.5. Properties of Orthogonality and Normalization . . . . .   | 732  |
| 20.6. Solutions of Mathieu's Modified Equation for Integral $\nu$ . . . . .   | 732  |
| 20.7. Representations by Integrals and Some Integral Equations . . . . .  | 735  |
| 20.8. Other Properties . . . . .  | 738  |
| 20.9. Asymptotic Representations . . . . .  | 740  |
| 20.10. Comparative Notations . . . . .  | 744  |
| <b>References</b> . . . . .   | 745  |
| <b>Table 20.1. Characteristic Values, Joining Factors, Some Critical Values (<math>0 \leq q \leq \infty</math>)</b> . . . . . | 748  |

Even Solutions

$$a_r, ce_r(0, q), ce_r\left(\frac{\pi}{2}, q\right), ce_r'\left(\frac{\pi}{2}, q\right), (4q)^{\frac{r}{2}} g_{e,r}(q), (4q)^r f_{e,r}(q)$$

Odd Solutions

$$b_r, se_r'(0, q), se_r\left(\frac{\pi}{2}, q\right), se_r'\left(\frac{\pi}{2}, q\right), (4q)^{\frac{r}{2}} g_{o,r}(q), (4q)^r f_{o,r}(q)$$

$$q=0(5)25, \quad 8D \text{ or } S$$

$$a_r + 2q - (4r + 2)\sqrt{q}, \quad b_r + 2q - (4r - 2)\sqrt{q}$$

$$q^{-1} = .16(-.04)0, \quad 8D$$

$$r=0, 1, 2, 5, 10, 15$$

|   |     |
|---|-----|
| <b>Table 20.2. Coefficients <math>A_m</math> and <math>B_m</math></b> . . . . . | 750 |
|---|-----|

$$q=5, 25; r=0, 1, 2, 5, 10, 15, \quad 9D$$

---

<sup>1</sup> Aeronautical Research Laboratories, Wright-Patterson Air Force Base, Ohio.



# 20. Mathieu Functions

## Mathematical Properties

### 20.1. Mathieu's Equation

#### Canonical Form of the Differential Equation

$$20.1.1 \quad \frac{d^2y}{dv^2} + (a - 2q \cos 2v)y = 0$$

#### Mathieu's Modified Differential Equation

$$20.1.2 \quad \frac{d^2f}{du^2} - (a - 2q \cosh 2u)f = 0 \quad (v = iu, y = f)$$

#### Relation Between Mathieu's Equation and the Wave Equation for the Elliptic Cylinder

The wave equation in Cartesian coordinates is

$$20.1.3 \quad \frac{\partial^2 W}{\partial x^2} + \frac{\partial^2 W}{\partial y^2} + \frac{\partial^2 W}{\partial z^2} + k^2 W = 0$$

A solution  $W$  is obtainable by separation of variables in elliptical coordinates. Thus, let

$$x = \rho \cosh u \cos v; \quad y = \rho \sinh u \sin v; \quad z = z;$$

$\rho$  a positive constant; 20.1.3 becomes

$$20.1.4 \quad * \frac{\partial^2 W}{\partial z^2} + \frac{2}{\rho^2 (\cosh 2u - \cos 2v)} \left( \frac{\partial^2 W}{\partial u^2} + \frac{\partial^2 W}{\partial v^2} \right) + k^2 W = 0$$

Assuming a solution of the form

$$W = \varphi(z)f(u)g(v)$$

and substituting the above into 20.1.4 one obtains, after dividing through by  $W$ ,

$$\frac{1}{\varphi} \frac{d^2 \varphi}{dz^2} + G = 0$$

where

$$* G = \frac{2}{\rho^2 (\cosh 2u - \cos 2v)} \left\{ \frac{d^2 f}{du^2} \frac{1}{f} + \frac{d^2 g}{dv^2} \frac{1}{g} \right\} + k^2$$

Since  $z, u, v$  are independent variables, it follows that

$$20.1.5 \quad \frac{d^2 \varphi}{dz^2} + c\varphi = 0$$

where  $c$  is a constant.

Again, from the fact that  $G = c$  and that  $u, v$  are independent variables, one sets

#### 20.1.6

$$* a = \frac{d^2 f}{du^2} \frac{1}{f} + \frac{(k^2 - c)}{2} \rho^2 \cosh 2u$$

$$a = -\frac{d^2 g}{dv^2} \frac{1}{g} + \frac{(k^2 - c)}{2} \rho^2 \cos 2v \quad *$$

where  $a$  is a constant. The above are equivalent to 20.1.1 and 20.1.2. The constants  $c$  and  $a$  are often referred to as *separation constants*, due to the role they play in 20.1.5 and 20.1.6.

For some physically important solutions, the function  $g$  must be periodic, of period  $\pi$  or  $2\pi$ . It can be shown that there exists a countably infinite set of *characteristic values*  $a_r(q)$  which yield even periodic solutions of 20.1.1; there is another countably infinite sequence of *characteristic values*  $b_r(q)$  which yield odd periodic solutions of 20.1.1.

It is known that there exist periodic solutions of period  $k\pi$ , where  $k$  is any positive integer. In what follows, however, the term *characteristic value* will be reserved for a value associated with solutions of period  $\pi$  or  $2\pi$  only. These characteristic values are of basic importance to the general theory of the differential equation for arbitrary parameters  $a$  and  $q$ .

#### An Algebraic Form of Mathieu's Equation

#### 20.1.7

$$(1-t^2) \frac{d^2 y}{dt^2} - t \frac{dy}{dt} + (a + 2q - 4qt^2)y = 0 \quad (\cos v = t)$$

#### Relation to Spheroidal Wave Equation

$$20.1.8 \quad (1-t^2) \frac{d^2 y}{dt^2} - 2(b+1)t \frac{dy}{dt} + (c - 4qt^2)y = 0 \quad *$$

Thus, Mathieu's equation is a special case of 20.1.8, with  $b = -\frac{1}{2}$ ,  $c = a + 2q$ .

### 20.2. Determination of Characteristic Values

A solution of 20.1.1 with  $v$  replaced by  $z$ , having period  $\pi$  or  $2\pi$  is of the form

$$20.2.1 \quad y = \sum_{m=0}^{\infty} (A_m \cos mz + B_m \sin mz)$$

where  $B_0$  can be taken as zero. If the above is substituted into 20.1.1 one obtains

#### 20.2.2

$$\sum_{m=-2}^{\infty} [(a - m^2)A_m - q(A_{m-2} + A_{m+2})] \cos mz + \sum_{m=-1}^{\infty} [(a - m^2)B_m - q(B_{m-2} + B_{m+2})] \sin mz = 0$$

$$A_{-m}, B_{-m} = 0 \quad m > 0$$

Equation 20.2.2 can be reduced to one of four simpler types, given in 20.2.3 and 20.2.4 below

20.2.3  $y_0 = \sum_{m=0}^{\infty} A_{2m+p} \cos(2m+p)z, \quad p=0 \text{ or } 1$

20.2.4  $y_1 = \sum_{m=0}^{\infty} B_{2m+p} \sin(2m+p)z, \quad p=0 \text{ or } 1$

If  $p=0$ , the solution is of period  $\pi$ ; if  $p=1$ , the solution is of period  $2\pi$ .

**Recurrence Relations Among the Coefficients**

Even solutions of period  $\pi$ :

20.2.5  $aA_0 - qA_2 = 0$

20.2.6  $(a-4)A_2 - q(2A_0 + A_4) = 0$

20.2.7  $(a-m^2)A_m - q(A_{m-2} + A_{m+2}) = 0 \quad (m \geq 3)$

Even solutions of period  $2\pi$ :

20.2.8  $(a-1)A_1 - q(A_1 + A_3) = 0,$

along with 20.2.7 for  $m \geq 3$ .

Odd solutions of period  $\pi$ :

20.2.9  $(a-4)B_2 - qB_4 = 0$

\* 20.2.10  $(a-m^2)B_m - q(B_{m-2} + B_{m+2}) = 0 \quad (m \geq 3)$

Odd solutions of period  $2\pi$ :

20.2.11  $(a-1)B_1 + q(B_1 - B_3) = 0,$

along with 20.2.10 for  $m \geq 3$ .

Let

20.2.12  $Ge_m = A_m/A_{m-2}, \quad Go_m = B_m/B_{m-2};$

$G_m = Ge_m$  or  $Go_m$  when the same operations apply to both, and no ambiguity is likely to arise. Further let

20.2.13  $V_m = (a-m^2)/q.$

Equations 20.2.5-20.2.7 are equivalent to

20.2.14  $Ge_2 = V_0; \quad Ge_4 = V_2 - \frac{2}{Ge_2}$

20.2.15  $G_m = 1/(V_m - G_{m+2}) \quad (m \geq 3),$

for even solutions of period  $\pi$ .

Similarly

20.2.16  $V_1 - 1 = Ge_3;$  for even solutions of period  $2\pi$ , along with 20.2.15

20.2.17  $V_1 + 1 = Go_3,$  for odd solutions of period  $2\pi$ , along with 20.2.15

20.2.18  $V_2 = Go_4,$  for odd solutions of period  $\pi$ , along with 20.2.15

These three-term recurrence relations among the coefficients indicate that every  $G_m$  can be developed into two types of continued fractions. Thus 20.2.15 is equivalent to

20.2.19

$$G_m = \frac{1}{V_m - G_{m+2}} = \frac{1}{V_m - \frac{1}{V_{m+2} - \frac{1}{V_{m+4} - \dots}}} \quad (m \geq 3)$$

20.2.20

$$G_{m+2} = V_m - 1/G_m = V_m - \frac{1}{V_{m-2} - \frac{1}{V_{m-4} - \dots - \frac{\varphi_0}{V_{0+d+\varphi_1}}}} \quad (m \geq 3)$$

where

$\varphi_1 = d = 0; \quad \varphi_0 = 2,$  if  $G_{m+2} = A_{2s}/A_{2s-2}$

$\varphi_1 = d = \varphi_0 = 0,$  if  $G_{m+2} = B_{2s}/B_{2s-2}$

$\varphi_1 = -1; \quad \varphi_0 = d = 1,$  if  $G_{m+2} = A_{2s+1}/A_{2s-1}$

$\varphi_1 = d = \varphi_0 = 1,$  if  $G_{m+2} = B_{2s+1}/B_{2s-1}$

The four choices of the parameters  $\varphi_1, \varphi_0, d$  correspond to the four types of solutions 20.2.3-20.2.4. Hereafter, it will be convenient to separate the characteristic values  $a$  into two major subsets:

$a = a_r,$  associated with even periodic solutions

$a = b_r,$  associated with odd periodic solutions

If 20.2.19 is suitably combined with 20.2.13-20.2.18 there result four types of continued fractions, the roots of which yield the required characteristic values

20.2.21  $V_0 - \frac{2}{V_2 - \frac{1}{V_4 - \frac{1}{V_6 - \dots}}} = 0 \quad \text{Roots: } a_{2r}$

20.2.22

$$V_1 - 1 - \frac{1}{V_3 - \frac{1}{V_5 - \frac{1}{V_7 - \dots}}} = 0 \quad \text{Roots: } a_{2r+1}$$

20.2.23  $V_2 - \frac{1}{V_4 - \frac{1}{V_6 - \frac{1}{V_8 - \dots}}} = 0 \quad \text{Roots: } b_{2r}$

20.2.24

$$V_1 + 1 - \frac{1}{V_3 - \frac{1}{V_5 - \frac{1}{V_7 - \dots}}} = 0 \quad \text{Roots: } b_{2r+1}$$

If  $a$  is a root of 20.2.21-20.2.24, then the corresponding solution exists and is an entire function of  $z$ , for general complex values of  $q$ .

If  $q$  is real, then the Sturmian theory of second order linear differential equations yields the

\*See page II.

following:

- (a) For a fixed real  $q$ , characteristic values  $a_r$  and  $b_r$  are real and distinct, if  $q \neq 0$ ;  $a_0 < b_1 < a_1 < b_2 < a_2 < \dots$ ,  $q > 0$  and  $a_r(q)$ ,  $b_r(q)$  approach  $r^2$  as  $q$  approaches zero.
- (b) A solution of 20.1.1 associated with  $a_r$  or  $b_r$  has  $r$  zeros in the interval  $0 \leq z < \pi$ , ( $q$  real).
- (c) The form of 20.2.21 and 20.2.23 shows that if  $a_{2r}$  is a root of 20.2.21 and  $q$  is different from zero, then  $a_{2r}$  cannot be a root of 20.2.23; similarly, no root of 20.2.22 can be a root of 20.2.24 if  $q \neq 0$ . It may be shown from other considerations that for a given point ( $a$ ,  $q$ ) there can be at most one periodic solution of period  $\pi$  or  $2\pi$  if  $q \neq 0$ . This no longer holds for solutions of period  $s\pi$ ,  $s \geq 3$ ; for these all solutions are periodic, if one is.

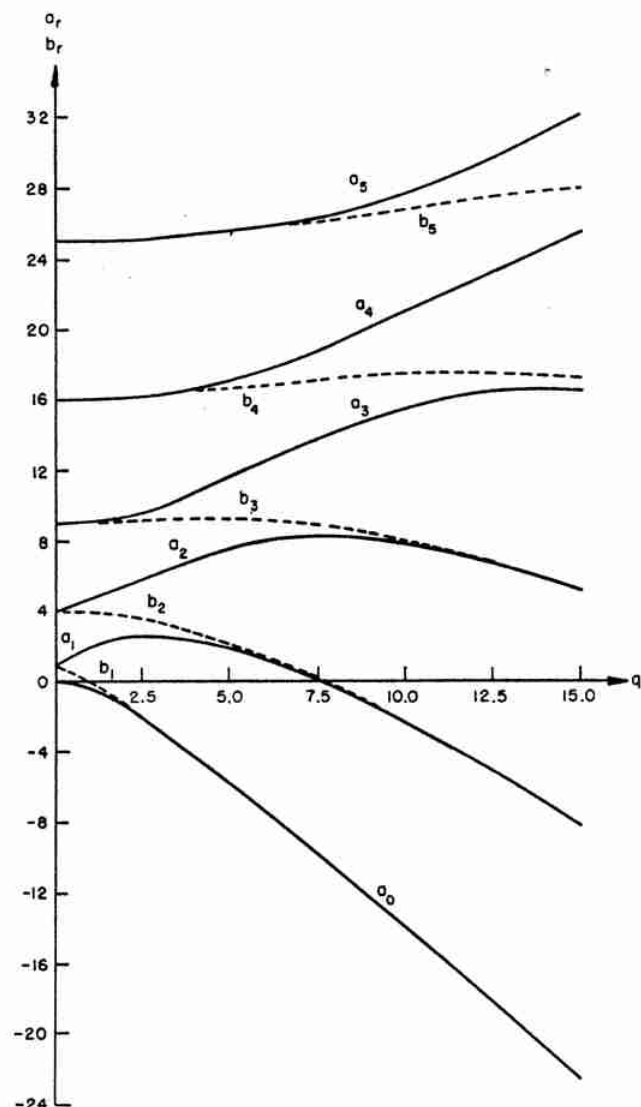

FIGURE 20.1. Characteristic Values  $a_r$ ,  $b_r$   $r=0,1(1)5$

### Power Series for Characteristic Values

#### 20.2.25

$$a_0(q) = -\frac{q^2}{2} + \frac{7q^4}{128} - \frac{29q^6}{2304} + \frac{68687q^8}{18874368} + \dots$$

$$a_1(-q) = 1 - q - \frac{q^2}{8} + \frac{q^3}{64} - \frac{q^4}{1536} - \frac{11q^5}{36864} + \frac{49q^6}{589824} - \frac{55q^7}{9437184} - \frac{83q^8}{35389440} + \dots$$

$$b_2(q) = 4 - \frac{q^2}{12} + \frac{5q^4}{13824} - \frac{289q^6}{79626240} + \frac{21391q^8}{458647142400} + \dots$$

$$a_2(q) = 4 + \frac{5q^2}{12} - \frac{763q^4}{13824} + \frac{1002401q^6}{79626240} - \frac{1669068401q^8}{458647142400} + \dots$$

$$a_3(-q) = 9 + \frac{q^2}{16} - \frac{q^3}{64} + \frac{13q^4}{20480} + \frac{5q^5}{16384} - \frac{1961q^6}{23592960} + \frac{609q^7}{104857600} + \dots$$

$$b_4(q) = 16 + \frac{q^2}{30} - \frac{317q^4}{864000} + \frac{10049q^6}{2721600000} + \dots$$

$$a_4(q) = 16 + \frac{q^2}{30} + \frac{433q^4}{864000} - \frac{5701q^6}{2721600000} + \dots$$

$$a_5(-q) = 25 + \frac{q^2}{48} + \frac{11q^4}{774144} - \frac{q^5}{147456} + \frac{37q^6}{891813888} + \dots$$

$$b_6(q) = 36 + \frac{q^2}{70} + \frac{187q^4}{43904000} - \frac{5861633q^6}{92935987200000} + \dots$$

$$a_6(q) = 36 + \frac{q^2}{70} + \frac{187q^4}{43904000} + \frac{6743617q^6}{92935987200000} + \dots$$

For  $r \geq 7$ , and  $|q|$  not too large,  $a_r$  is approximately equal to  $b_r$ , and the following approximation may be used

#### 20.2.26

$$\left. \begin{aligned} a_r \\ b_r \end{aligned} \right\} = r^2 + \frac{q^2}{2(r^2-1)} + \frac{(5r^2+7)q^4}{32(r^2-1)^3(r^2-4)} + \frac{(9r^4+58r^2+29)q^6}{64(r^2-1)^5(r^2-4)(r^2-9)} + \dots$$

The above expansion is not limited to integral values of  $r$ , and it is a very good approximation for  $r$  of the form  $n + \frac{1}{2}$  where  $n$  is an integer. In case of integral values of  $r=n$ , the series holds only up to terms not involving  $r^2 - n^2$  in the denominator. Subsequent terms must be derived specially (as shown by Mathieu). Mulholland and Goldstein [20.38] have computed characteristic values for purely imaginary  $q$  and found that  $a_0$  and  $a_2$  have a common real value for  $|q|$  in the neighborhood of 1.468; Bouwkamp [20.5] has computed this number as  $q_0 = \pm i 1.46876852$  to 8 decimals. For values of  $-iq > -iq_0$ ,  $a_0$  and  $a_2$  are conjugate complex numbers. From equation 20.2.25 it follows that the radius of convergence for the series defining  $a_0$  is no greater than  $|q_0|$ . It is shown in [20.36], section 2.25 that the radius of convergence for  $a_{2n}(q)$ ,  $n \geq 2$  is greater than 3. Furthermore

$$a_r - b_r = O(q^r / r^{r-1}), \quad r \rightarrow \infty.$$

**Power Series in  $q$  for the Periodic Functions (for sufficiently small  $|q|$ )**

**20.2.27**

$$ce_0(z, q) = 2^{-\frac{1}{2}} \left[ 1 - \frac{q}{2} \cos 2z + q^2 \left( \frac{\cos 4z}{32} - \frac{1}{16} \right) - q^3 \left( \frac{\cos 6z}{1152} - \frac{11 \cos 2z}{128} \right) + \dots \right]$$

$$ce_1(z, q) = \cos z - \frac{q}{8} \cos 3z + q^2 \left[ \frac{\cos 5z}{192} - \frac{\cos 3z}{64} - \frac{\cos z}{128} \right] - q^3 \left[ \frac{\cos 7z}{9216} - \frac{\cos 5z}{1152} - \frac{\cos 3z}{3072} + \frac{\cos z}{512} \right] + \dots$$

$$se_1(z, q) = \sin z - \frac{q}{8} \sin 3z + q^2 \left[ \frac{\sin 5z}{192} + \frac{\sin 3z}{64} - \frac{\sin z}{128} \right] - q^3 \left[ \frac{\sin 7z}{9216} + \frac{\sin 5z}{1152} - \frac{\sin 3z}{3072} - \frac{\sin z}{512} \right] + \dots$$

$$ce_2(z, q) = \cos 2z - q \left( \frac{\cos 4z}{12} - \frac{1}{4} \right) + q^2 \left( \frac{\cos 6z}{384} - \frac{19 \cos 2z}{288} \right) + \dots$$

$$se_2(z, q) = \sin 2z - q \frac{\sin 4z}{12} + q^2 \left( \frac{\sin 6z}{384} - \frac{\sin 2z}{288} \right) + \dots$$

**20.2.28**

$$ce_r(z, q) = \cos(rz - p(\pi/2)) - q \left\{ \frac{\cos[(r+2)z - p(\pi/2)]}{4(r+1)} - \frac{\cos[(r-2)z - p(\pi/2)]}{4(r-1)} \right\} + q^2 \left\{ \frac{\cos[(r+4)z - p(\pi/2)]}{32(r+1)(r+2)} + \frac{\cos[(r-4)z - p(\pi/2)]}{32(r-1)(r-2)} - \frac{\cos[rz - p(\pi/2)]}{32} \left[ \frac{2(r^2+1)}{(r^2-1)^2} \right] \right\} + \dots$$

with  $p=0$  for  $ce_r(z, q)$ ,  $p=1$  for  $se_r(z, q)$ ,  $r \geq 3$ .

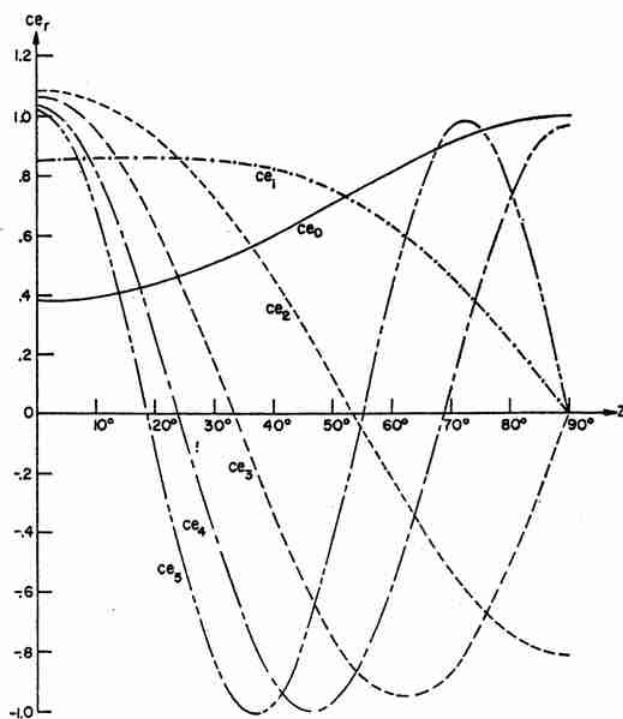

FIGURE 20.2. Even Periodic Mathieu Functions, Orders 0-5  $q=1$ .

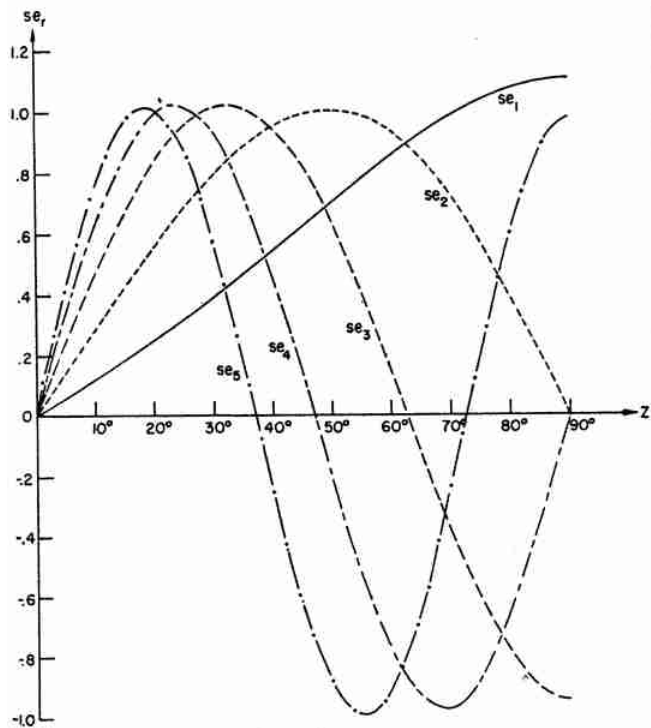

FIGURE 20.3. Odd Periodic Mathieu Functions, Orders 1-5  $q=1$ .

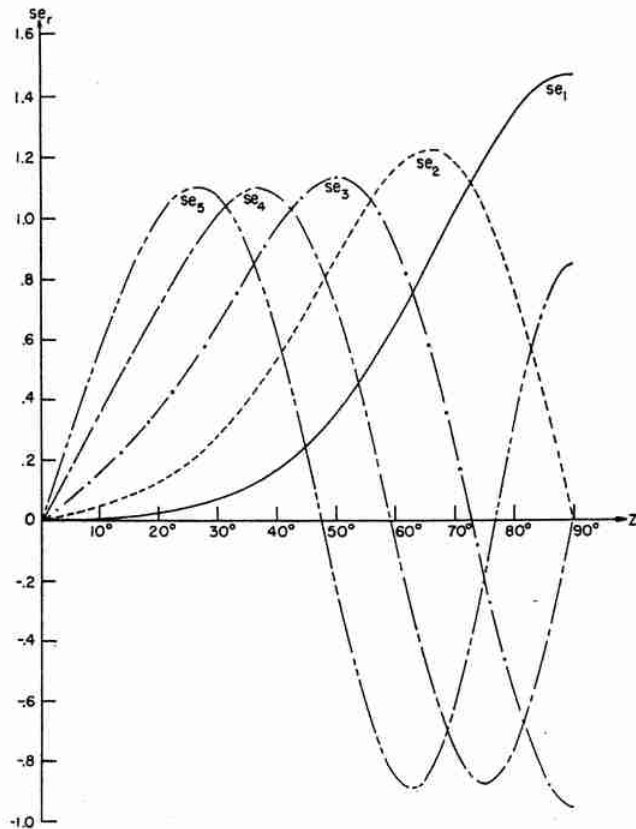

FIGURE 20.5. Odd Periodic Mathieu Functions, Orders 1-5  $q=10$ .

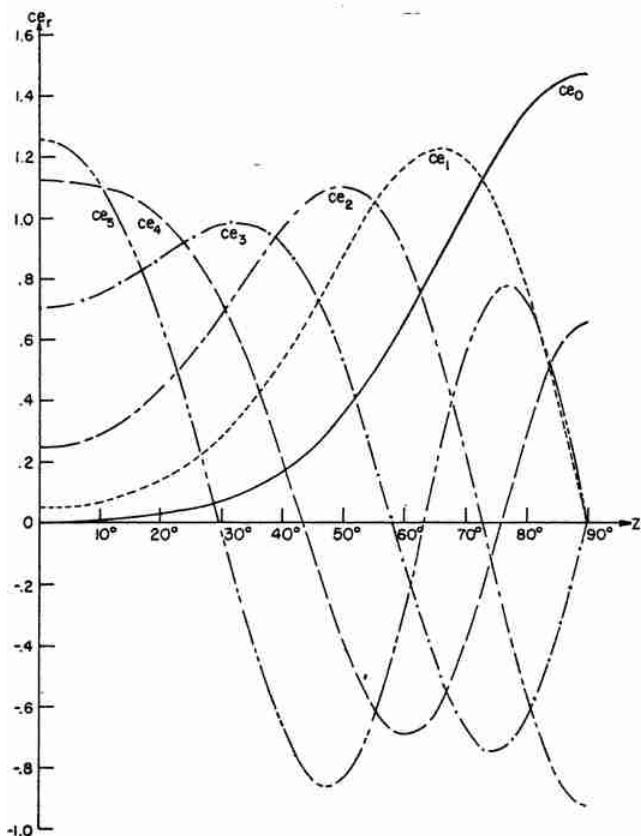

FIGURE 20.4. Even Periodic Mathieu Functions, Orders 0-5  $q=10$ .

For coefficients associated with above functions

20.2.29

$$A_0^0(0) = 2^{-1/2}; A_r^r(0) = B_r^r(0) = 1, r > 0$$

$$A_{2s}^0 = [(-1)^s q^s / s! s! 2^{2s-1}] A_0^0 + \dots, s > 0$$

$$A_{r+2s}^r = [(-1)^s r! q^s / 4^s (r+s)! s!] C_r^r + \dots$$

$$B_{r+2s}^r = [(-1)^s r! q^s / 4^s (r+s)! s!] C_r^r + \dots$$

$rs > 0, C_r^r = A_r^r \text{ or } B_r^r$

$$A_{r-2s}^r \text{ or } B_{r-2s}^r = \frac{(r-s-1)! q^s}{s!(r-1)! 4^s} C_r^r + \dots$$

Asymptotic Expansion for Characteristic Values,  $q \gg 1$

Let  $w = 2r + 1, q = w^4 \varphi, \varphi$  real. Then

20.2.30

$$a_r \sim b_{r+1} \sim -2q + 2w\sqrt{q} - \frac{w^2 + 1}{8} - \frac{(w + \frac{3}{w})}{2^7 \sqrt{\varphi}}$$

$$-\frac{d_1}{2^{12} \varphi} - \frac{d_2}{2^{17} \varphi^{3/2}} - \frac{d_3}{2^{20} \varphi^2} - \frac{d_4}{2^{25} \varphi^{5/2}} - \dots$$

where

$$d_1 = 5 + \frac{34}{w^2} + \frac{9}{w^4}$$

$$d_2 = \frac{33}{w} + \frac{410}{w^3} + \frac{405}{w^5}$$

$$d_3 = \frac{63}{w^2} + \frac{1260}{w^4} + \frac{2943}{w^6} + \frac{486}{w^8}$$

$$d_4 = \frac{527}{w^3} + \frac{15617}{w^5} + \frac{69001}{w^7} + \frac{41607}{w^9}$$

**20.2.31**  $b_{r+1} - a_r \sim 2^{4r+5} \sqrt{2/\pi} q^{3r+4} e^{-4\sqrt{q}}/r!$ ,  $q \rightarrow \infty$   
(given in [20.36] without proof.)

**20.3. Floquet's Theorem and Its Consequences**

Since the coefficients of Mathieu's equation

**20.3.1**  $y'' + (a - 2q \cos 2z)y = 0$

are periodic functions of  $z$ , it follows from the known theory relating to such equations that there exists a solution of the form

**20.3.2**  $F_\nu(z) = e^{i\nu z} P(z)$ ,

where  $\nu$  depends on  $a$  and  $q$ , and  $P(z)$  is a periodic function, of the same period as that of the coefficients in **20.3.1**, namely  $\pi$ . (Floquet's theorem; see [20.16] or [20.22] for its more general form.) The constant  $\nu$  is called the *characteristic exponent*. Similarly

**20.3.3**  $F_\nu(-z) = e^{-i\nu z} P(-z)$

satisfies **20.3.1** whenever **20.3.2** does. Both  $F_\nu(z)$  and  $F_\nu(-z)$  have the property

**20.3.4**

$$y(z+k\pi) = C^k y(z), \quad y = F_\nu(z) \text{ or } F_\nu(-z),$$

$$C = e^{i\nu\pi} \text{ for } F_\nu(z), \quad C = e^{-i\nu\pi} \text{ for } F_\nu(-z)$$

Solutions having the property **20.3.4** will hereafter be termed *Floquet solutions*. Whenever  $F_\nu(z)$  and  $F_\nu(-z)$  are linearly independent, the general solution of **20.3.1** can be put into the form

**20.3.5**  $y = AF_\nu(z) + BF_\nu(-z)$

If  $AB \neq 0$ , the above solution will *not* be a *Floquet solution*. It will be seen later, from the method for determining  $\nu$  when  $a$  and  $q$  are given, that there is some ambiguity in the definition of  $\nu$ ; namely,  $\nu$  can be replaced by  $\nu + 2k$ , where  $k$  is an arbitrary integer. This is as it should be, since the addition of the factor  $\exp(2ikz)$  in **20.3.2** still leaves a periodic function of period  $\pi$  for the coefficient of  $\exp i\nu z$ .

It turns out that when  $a$  belongs to the set of characteristic values  $a_r$  and  $b_r$  of **20.2**, then  $\nu$  is zero or an integer. It is convenient to associate  $\nu = r$  with  $a_r(q)$ , and  $\nu = -r$  with  $b_r(q)$ ; see [20.36]. In the special case when  $\nu$  is an integer,  $F_\nu(z)$  is

proportional to  $F_\nu(-z)$ ; the second, independent solution of **20.3.1** then has the form

**20.3.6**  $y_2 = z c e_r(z, q) + \sum_{k=0}^{\infty} d_{2k+p} \sin(2k+p)z$ ,  
associated with  $c e_r(z, q)$

**20.3.7**  $y_2 = z s e_r(z, q) + \sum_{k=0}^{\infty} f_{2k+p} \cos(2k+p)z$ ,  
associated with  $s e_r(z, q)$

The coefficients  $d_{2k+p}$  and  $f_{2k+p}$  depend on the corresponding coefficients  $A_m$  and  $B_m$ , respectively, of **20.2**, as well as on  $a$  and  $q$ . See [20.30], section (7.50)–(7.51) and [20.58], section V, for details.

If  $\nu$  is not an integer, then the Floquet solutions  $F_\nu(z)$  and  $F_\nu(-z)$  are linearly independent. It is clear that **20.3.2** can be written in the form

**20.3.8**  $F_\nu(z) = \sum_{k=-\infty}^{\infty} c_{2k} e^{i(\nu+2k)z}$ .

From **20.3.8** it follows that if  $\nu$  is a proper fraction  $m_1/m_2$ , then every solution of **20.3.1** is periodic, and of period at most  $2\pi m_2$ . This agrees with results already noted in **20.2**; i.e., both independent solutions are periodic, if one is, provided the period is different from  $\pi$  and  $2\pi$ .

**Method of Generating the Characteristic Exponent**

Define two linearly independent solutions of **20.3.1**, for fixed  $a, q$  by

**20.3.9**  $y_1(0) = 1; y_1'(0) = 0.$   
 $y_2(0) = 0; y_2'(0) = 1.$

Then it can be shown that

**20.3.10**  $\cos \pi\nu - y_1(\pi) = 0$

**20.3.11**  $\cos \pi\nu - 1 - 2y_1'(\frac{\pi}{2}) y_2(\frac{\pi}{2}) = 0$

Thus  $\nu$  may be obtained from a knowledge of  $y_1(\pi)$  or from a knowledge of both  $y_1'(\frac{\pi}{2})$  and  $y_2(\frac{\pi}{2})$ . For numerical purposes **20.3.11** may be more desirable because of the shorter range of integration, and hence the lesser accumulation of round-off errors. Either  $\nu, -\nu$ , or  $\pm\nu + 2k$  ( $k$  an arbitrary integer) can be taken as the solution of **20.3.11**. Once  $\nu$  has been fixed, the coefficients of **20.3.8** can be determined, except for an arbitrary multiplier which is independent of  $z$ .

The characteristic exponent can also be computed from a continued fraction, in a manner analogous to developments in **20.2**, if a sufficiently close first approximation to  $\nu$  is available. For



systematic tabulation, this method is considerably faster than the method of numerical integration. Thus, when 20.3.8 is substituted into 20.3.1, there result the following recurrence relations:

$$20.3.12 \quad V_{2n}c_{2n} = c_{2n-2} + c_{2n+2}$$

where

$$20.3.13 \quad V_{2n} = [a - (2n + \nu)^2] / q, \quad -\infty < n < \infty.$$

When  $\nu$  is complex, the coefficients  $V_{2n}$  may also be complex. As in 20.2, it is possible to generate the ratios

$$G_m = c_m / c_{m-2} \text{ and } H_{-m} = c_{-m-2} / c_{-m}$$

from the continued fractions

20.3.14

$$G_m = \frac{1}{V_m - \frac{1}{V_{m+2} - \dots}}, \quad m \geq 0$$

$$H_{-m} = \frac{1}{V_{-m-2} - \frac{1}{V_{-m-4} - \dots}}, \quad m \geq 0.$$

From the form of 20.3.13 and the known properties of continued fractions it is assured that for sufficiently large values of  $|m|$  both  $|G_m|$  and  $|H_{-m}|$  converge. Once values of  $G_m$  and  $H_{-m}$  are available for some sufficiently large value of  $m$ , then the finite number of ratios  $G_{m-2}, G_{m-4}, \dots, G_0$  can be computed in turn, if they exist. Similarly for  $H_{-m+2}, \dots, H_0$ . It is easy to show that  $\nu$  is the correct characteristic exponent, appropriate for the point  $(a, q)$ , if and only if  $H_0 G_0 = 1$ . An iteration technique can be used to improve the value of  $\nu$ , by the method suggested in [20.3]. One coefficient  $c_j$  can be assigned arbitrarily; the rest are then completely determined. After all the  $c_j$  become available, a multiplier (depending on  $q$  but not on  $z$ ) can be found to satisfy a prescribed normalization.

It is well known that continued fractions can be converted to determinantal form. Equation 20.3.14 can in fact be written as a determinant with an infinite number of rows—a special case of Hill's determinant. See [20.19], [20.36], [20.15], or [20.30] for details. Although the determinant has actually been used in computations where high-speed computers were available, the direct use of the continued fraction seems much less laborious.

**Special Cases ( $a, q$  Real)**

Corresponding to  $q=0, y_1 = \cos \sqrt{a}z, y_2 = \sin \sqrt{a}z$ ; the Floquet solutions are  $\exp(iaz)$  and  $\exp(-iaz)$ . As  $a, q$  vary continuously in the  $q$ - $a$  plane,  $\nu$  describes curves;  $\nu$  is real when  $(q, a), q \geq 0$  lies in the region between  $a_r(q)$  and  $b_{r+1}(q)$  and

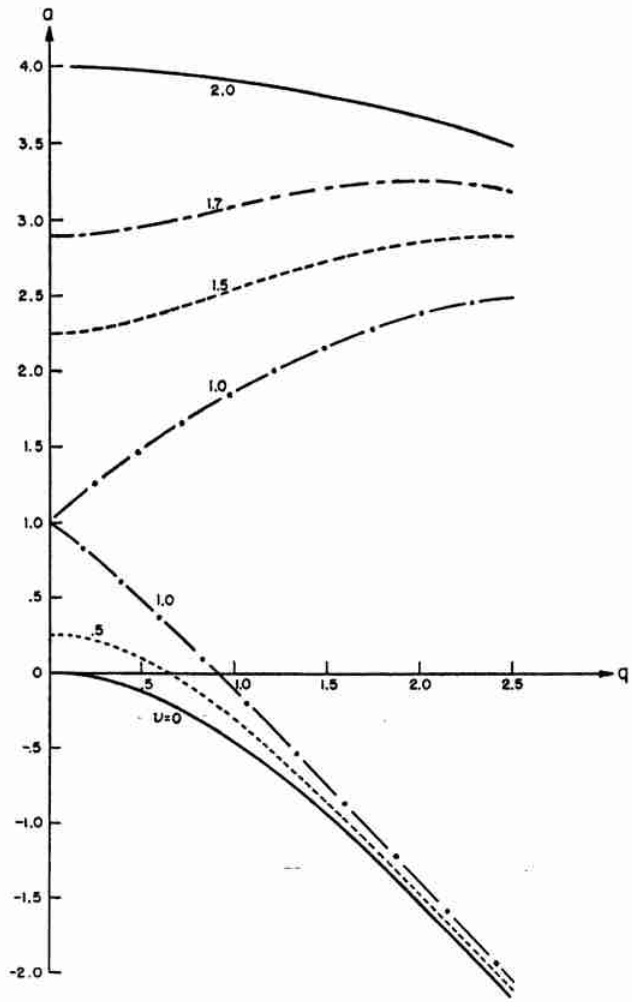

FIGURE 20.6. Characteristic Exponent-First Two Stable Regions  $y = e^{i\nu z}P(x)$  where  $P(x)$  is a periodic function of period  $\pi$ .

Definition of  $\nu$ ;

In first stable region,  $0 \leq \nu \leq 1$ ,

In second stable region,  $1 \leq \nu \leq 2$ .

(Constructed from tabular values supplied by T. Tamir, Brooklyn Polytechnic Institute)

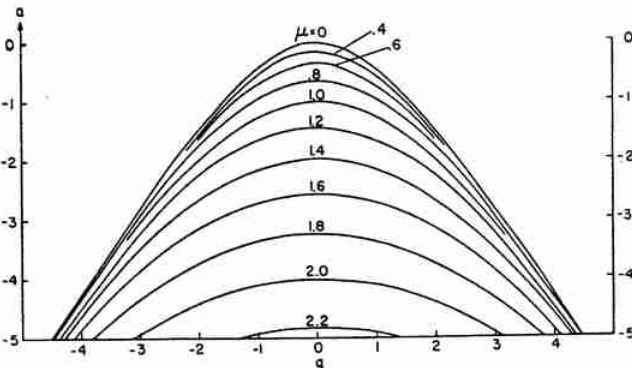

FIGURE 20.7. Characteristic Exponent in First Unstable Region. Differential equation:  $y'' + (a - 2q \cos 2x)y = 0$ . The Floquet solution  $y = e^{i\nu z}P(x)$ , where  $P(x)$  is a periodic function of period  $\pi$ . In the first unstable region,  $\nu = i\mu$ ;  $\mu$  is given for  $a \geq -5$ . (Constructed at NBS.)



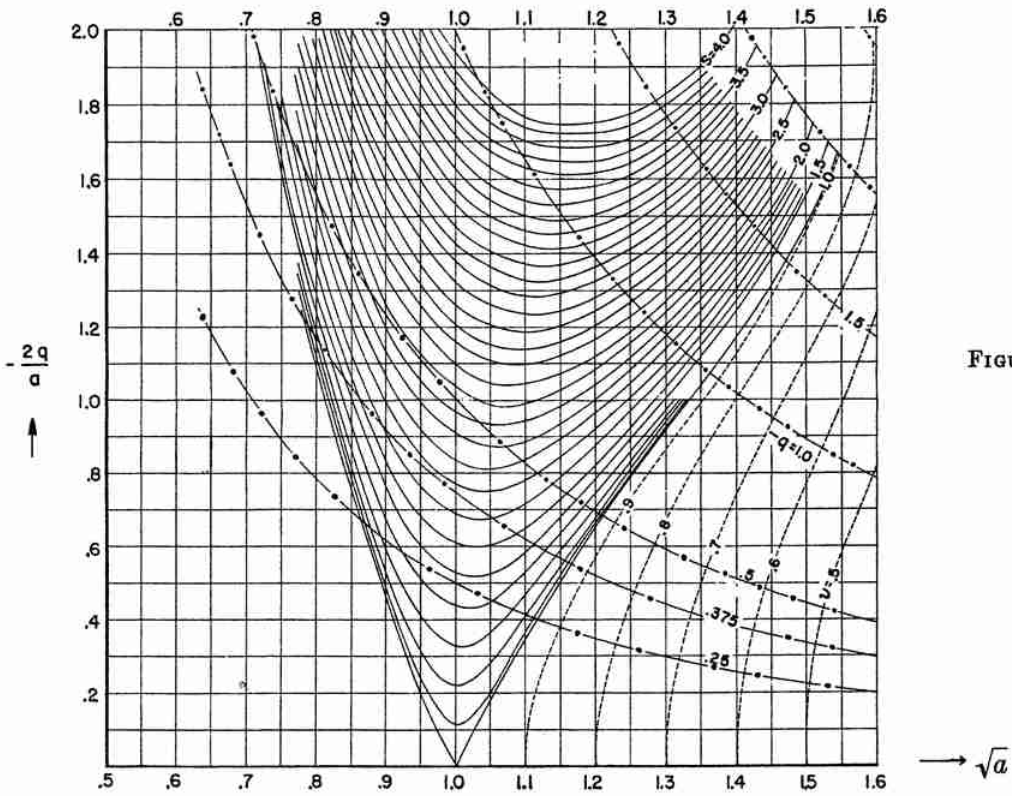

FIGURE 20.8

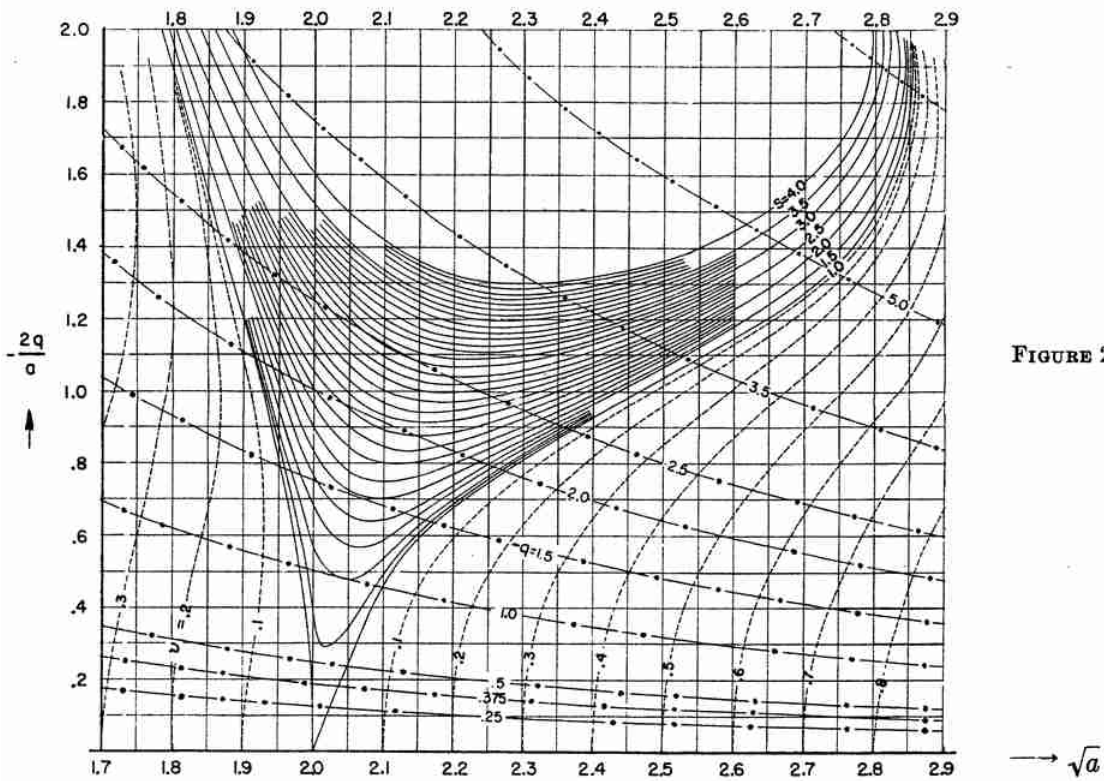

FIGURE 20.9

*Charts of the Characteristic Exponent.*

(From S. J. Zarodny, An elementary review of the Mathieu-Hill equation of real variable based on numerical solutions, Ballistic Research Laboratory Memo. Rept. 878, Aberdeen Proving Ground, Md., 1955, with permission.)

- $s = e^{\nu\pi} = \text{constant}$ ; in unstable regions
- - -  $\nu = \text{constant}$ ; in stable regions
- . - . Lines of constant values of  $-q$ .

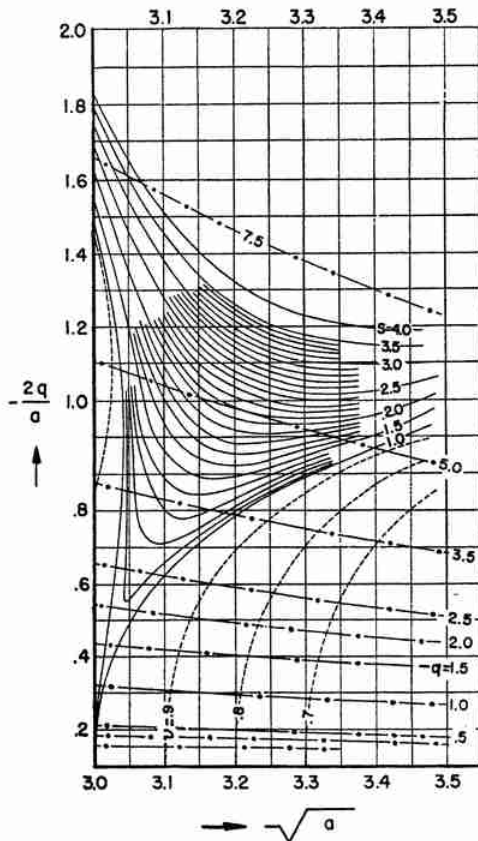

FIGURE 20.10. Chart of the Characteristic Exponent.

(From S. J. Zarodny, An elementary review of the Mathieu-Hill equation of real variable based on numerical solutions, Ballistic Research Laboratory Memo. Rept. 878, Aberdeen Proving Ground, Md., 1955, with permission)

- $s = e^{i\nu\pi} = \text{constant}$ ; in unstable regions
- - -  $\nu = \text{constant}$ ; in stable regions
- . - Lines of constant values of  $-q$ .

all solutions of 20.1.1 for real  $z$  are therefore bounded (stable);  $\nu$  is complex in regions between  $b_r$  and  $a_r$ ; in these regions every solution becomes infinite at least once; hence these regions are termed "unstable regions". The characteristic curves  $a_r, b_r$  separate the regions of stability. For negative  $q$ , the stable regions are between  $b_{2r+1}$  and  $b_{2r+2}, a_{2r}$  and  $a_{2r+1}$ ; the unstable regions are between  $a_{2r+1}$  and  $b_{2r+1}, a_{2r}$  and  $b_{2r}$ .

In some problems solutions are required for real values of  $z$  only. In such cases a knowledge of the characteristic exponent  $\nu$  and the periodic function  $P(z)$  is sufficient for the evaluation of the required functions. For complex values of  $z$ , however, the series defining  $P(z)$  converges slowly. Other solutions will be determined in the next section; they all have the remarkable property that they depend on the same coefficients  $c_m$  developed in connection with Floquet's theorem (except for an arbitrary normalization factor).

Expansions for Small  $q$  ([20.36] chapter 2)

If  $\nu, q$  are fixed:

20.3.15

$$a = \nu^2 + \frac{q^2}{2(\nu^2-1)} + \frac{(5\nu^2+7)q^4}{32(\nu^2-1)^3(\nu^2-4)} + \frac{(9\nu^4+58\nu^2+29)q^6}{64(\nu^2-1)^5(\nu^2-4)(\nu^2-9)} + \dots \quad (\nu \neq 1, 2, 3).$$

For the coefficients  $c_2$ , of 20.3.8

20.3.16

$$c_2/c_0 = \frac{-q}{4(\nu+1)} - \frac{(\nu^2+4\nu+7)q^3}{128(\nu+1)^3(\nu+2)(\nu-1)} + \dots \quad (\nu \neq 1, 2)$$

$$c_4/c_0 = q^2/32(\nu+1)(\nu+2) + \dots$$

$$c_{2s}/c_0 = (-1)^s q^s \Gamma(\nu+1) / 2^{2s} s! \Gamma(\nu+s+1) + \dots$$

20.3.17

$$F_\nu(z) = c_0 \left[ e^{i\nu z} - q \left\{ \frac{e^{i(\nu+2)z}}{4(\nu+1)} - \frac{e^{i(\nu-2)z}}{4(\nu-1)} \right\} \right] + \dots \quad (\nu \text{ not an integer})$$

For small values of  $a$

20.3.18

$$\cos \nu \pi = \left( 1 - \frac{a\pi^2}{2} + \frac{a^2\pi^4}{24} + \dots \right) - \frac{q^2\pi^2}{4} \left[ 1 + a \left( 1 - \frac{\pi^2}{6} \right) + \dots \right] + q^4 \left( \frac{\pi^4}{96} - \frac{25\pi^2}{256} + \dots \right) + \dots$$

20.4. Other Solutions of Mathieu's Equation

Following Erdélyi [20.14], [20.15], define

20.4.1  $\varphi_k(z) = [e^{i\pi} \cos(z-b) / \cos(z+b)]^{1/2} J_k(f)$

where

20.4.2  $f = 2[q \cos(z-b) \cos(z+b)]^{1/2}$ ,

and  $J_k(f)$  is the Bessel function of order  $k$ ;  $b$  is a fixed, arbitrary complex number. By using the recurrence relations for Bessel functions the following may be verified:

20.4.3

$$\frac{d^2 \varphi_k}{dz^2} - 2q(\cos 2z)\varphi_k + q(\varphi_{k-2} + \varphi_{k+2}) + k^2 \varphi_k = 0.$$

It follows that a formal solution of 20.1.1 is given by

20.4.4  $y = \sum_{n=-\infty}^{\infty} c_{2n} \varphi_{2n+\nu}$

where the coefficients  $c_{2n}$  are those associated with Floquet's solution. In the above,  $\nu$  may be complex. Except for the special case when  $\nu$  is an integer, the following holds:

$$\frac{\varphi_{2n+\nu-2}}{\varphi_{2n+\nu}} \sim \frac{\varphi_{-2n+\nu}}{\varphi_{-2n+\nu+2}} \sim \frac{-4n^2}{q[\cos(z-b)]^2} \quad (n \rightarrow \infty)$$

If  $\nu$  and  $n$  are integers,  $J_{-2n+\nu}(f) = (-1)^\nu J_{2n-\nu}(f)$ .

$$\begin{aligned} [\varphi_{2n+\nu}/\varphi_{2n+\nu-2}] &\sim -[\cos(z-b)]^2 q/4n^2 \\ [\varphi_{-2n+\nu}/\varphi_{-2n+\nu+2}] &\sim -4n^2/q[\cos(z-b)]^2 \end{aligned}$$

On the other hand

$$\frac{c_{2n}}{c_{2n-2}} \sim \frac{c_{-2n}}{c_{-2n+2}} \sim \frac{-q}{4n^2} \quad (n \rightarrow \infty)$$

It follows that 20.4.4 converges absolutely and uniformly in every closed region where

$$|\cos(z-b)| > d_1 > 1.$$

There are two such disjoint regions:

- (I)  $\mathcal{I}(z-b) > d_2 > 0; (|\cos(z-b)| > d_1 > 1)$
- (II)  $\mathcal{I}(z-b) < -d_2 < 0; (|\cos(z-b)| > d_1 > 1)$

If  $\nu$  is an integer 20.4.4 converges for all values of  $z$ . Various representations are found by specializing  $b$ .

**20.4.5**

If  $b=0, y=e^{i\pi\nu/2} \sum_{n=-\infty}^{\infty} c_{2n}(-1)^n J_{2n+\nu}(2\sqrt{q} \cos z)$   
 $(|\cos z| > 1, |\arg 2\sqrt{q} \cos z| \leq \pi)$

**20.4.6**

If  $b=\frac{\pi}{2}, y=\sum_{n=-\infty}^{\infty} c_{2n} J_{2n+\nu}(2i\sqrt{q} \sin z)$   
 $(|\sin z| > 1, |\arg 2\sqrt{q} \sin z| \leq \pi)$

If  $b \rightarrow \infty i, y$  reduces to a multiple of the solution 20.3.8. The fact that 20.3.8, 20.4.5, and 20.4.6 are special cases of 20.4.4 explains why it is that these apparently dissimilar expansions involve the same set of coefficients  $c_{2n}$ .

Since 20.4.4 results from the recurrence properties of Bessel functions,  $J_k(f)$  can be replaced by  $H_k^{(j)}(f), j=1, 2$ , where  $H_k^{(j)}$  is the Hankel function, at least formally. Thus let

$$\psi_k^j = [e^{i\pi} \cos(z-b)/\cos(z+b)]^{1/2} H_k^{(j)}(f)$$

where  $f$  satisfies 20.4.2. An examination of the ratios  $\psi_{2n+\nu}/\psi_{2n+\nu-2}$  shows that

$$y = \sum_{n=-\infty}^{\infty} c_{2n} \psi_{2n+\nu}^{(j)}$$

will be a solution provided

$$|\cos(z-b)| > 1; |\cos(z+b)| > 1.$$

The above two conditions are necessary even when  $\nu$  is an integer. Once  $b$  is fixed, the regions in which the solutions converge can be readily established.

Following [20.36] let

**20.4.7**

$$\begin{aligned} J_p(x) &= Z_p^{(1)}(x); \quad Y_p(x) = Z_p^{(2)}(x); \\ H_p^{(1)}(x) &= Z_p^{(3)}(x); \quad H_p^{(2)}(x) = Z_p^{(4)}(x) \end{aligned}$$

If  $z$  is replaced by  $-iz$  in 20.4.5 and 20.4.6 solutions of 20.1.2 are obtained. Thus

**20.4.8**

$$y_1^{(j)}(z) = \sum_{n=-\infty}^{\infty} c_{2n} (-1)^n Z_{2n+\nu}^{(j)}(2\sqrt{q} \cosh z) \quad (|\cosh z| > 1)$$

**20.4.9**

$$y_2^{(j)}(z) = \sum_{n=-\infty}^{\infty} c_{2n} Z_{2n+\nu}^{(j)}(2\sqrt{q} \sinh z) \quad (|\sinh z| > 1, j=1, 2, 3, 4)$$

The relation between  $y_1^{(j)}(z)$  and  $y_2^{(j)}(z)$  can be determined from the asymptotic properties of the Bessel functions for large values of argument. It can be shown that

**20.4.10**

$$y_1^{(j)}(z)/y_2^{(j)}(z) = [F_\nu(0)/F_\nu(\frac{\pi}{2})] e^{i\nu\pi/2} \quad (\Re z > 0).$$

When  $\nu$  is not an integer, the above solutions do not vanish identically. See 20.6 for integral values of  $\nu$ .

**Solutions Involving Products of Bessel Functions**

**20.4.11**

$$y_3^{(j)}(z) = \frac{1}{c_{2s}} \sum_{n=-\infty}^{\infty} c_{2n} (-1)^n Z_{2n+\nu+s}^{(j)}(\sqrt{q}e^{iz}) J_{n-s}(\sqrt{q}e^{-iz}) \quad (j=1, 2, 3, 4)$$

satisfies 20.1.1, where  $Z_n^{(j)}(u)$  is defined in 20.4.7, the coefficients  $c_{2n}$  belong to the Floquet solution, and  $s$  is an arbitrary integer,  $c_{2s} \neq 0$ . The solution converges over the entire complex  $z$ -plane if  $q \neq 0$ . Written with  $z$  replaced by  $-iz$ , one obtains solutions of 20.1.2.

20.4.12

$$M_j^\nu(z, q) = \frac{1}{c_{2s}^\nu} \sum_{n=-\infty}^{\infty} c_{2n}^\nu (-1)^n Z_{n+\nu+s}^{(j)}(\sqrt{q}e^z) J_{n-s}(\sqrt{q}e^{-z})$$

It can be verified from 20.4.8 and 20.4.12 that

20.4.13  $\frac{y_1^{(j)}(z)}{M_j^\nu(z, q)} = F_\nu(0), \quad (\Re z > 0)$

provided  $c_{2s} \neq 0$ . If  $c_{2s} = 0$ , the coefficient of  $1/c_{2s}$  in 20.4.11 vanishes identically. For details see [20.43], [20.15], [20.36].

If  $s$  is chosen so that  $|c_{2s}|$  is the largest coefficient of the set  $|c_{2j}|$ , then rapid convergence of 20.4.12 is obtained, when  $\Re z > 0$ . Even then one must be on guard against the possible loss of significant figures in the process of summing the series, especially so when  $q$  is large, and  $|z|$  small. (If  $j \neq 1$ , then the phase of the logarithmic terms occurring in 20.4.12 must be defined, to make the functions single-valued.)

20.5. Properties of Orthogonality and Normalization

If  $a(\nu+2p, q)$ ,  $a(\nu+2s, q)$  are simple roots of 20.3.10 then

20.5.1  $\int_0^{2\pi} F_{\nu+2p}(z) F_{\nu+2s}(-z) dz = 0$ , if  $p \neq s$ .

Define

20.5.2  $ce_\nu(z, q) = \frac{1}{2} [F_\nu(z) + F_\nu(-z)];$   
 $se_\nu(z, q) = -i \frac{1}{2} [F_\nu(z) - F_\nu(-z)]$

$ce_\nu(z, q)$ ,  $se_\nu(z, q)$  are thus even and odd functions of  $z$ , respectively, for all  $\nu$  (when not identically zero).

If  $\nu$  is an integer, then  $ce_\nu(z, q)$ ,  $se_\nu(z, q)$  are either Floquet solutions or identically zero. The solutions  $ce_r(z, q)$  are associated with  $a_r$ ;  $se_r(z, q)$  are associated with  $b_r$ ;  $r$  an integer.

Normalization for Integral Values of  $\nu$  and Real  $q$

20.5.3  $\int_0^{2\pi} [ce_r(z, q)]^2 dz = \int_0^{2\pi} [se_r(z, q)]^2 dz = \pi$

For integral values of  $\nu$  the summation in 20.3.8 reduces to the simpler forms 20.2.3–20.2.4; on account of 20.5.3, the coefficients  $A_m$  and  $B_m$  (for all orders  $r$ ) have the property

20.5.4

$$2A_0^2 + A_2^2 + \dots = A_1^2 + A_3^2 + \dots = B_1^2 + B_3^2 + \dots = B_2^2 + B_4^2 + \dots = 1.$$

20.5.5

$$A_0^r = \frac{1}{2\pi} \int_0^{2\pi} ce_{2s}(z, q) dz; \quad A_n^r = \frac{1}{\pi} \int_0^{2\pi} ce_r(z, q) \cos n z dz$$

$$B_n^r = \frac{1}{\pi} \int_0^{2\pi} se_r(z, q) \sin n z dz \quad n \neq 0$$

For integral values of  $\nu$ , the functions  $ce_r(z, q)$  and  $se_r(z, q)$  form a complete orthogonal set for the interval  $0 \leq z \leq 2\pi$ . Each of the four systems  $ce_{2r}(z)$ ,  $ce_{2r+1}(z)$ ,  $se_{2r}(z)$ ,  $se_{2r+1}(z)$  is complete in the smaller interval  $0 \leq z \leq \frac{1}{2}\pi$ , and each of the systems  $ce_r(z)$ ,  $se_r(z)$  is complete in  $0 \leq z \leq \pi$ .

If  $q$  is not real, there exist multiple roots of 20.3.10; for such special values of  $a(q)$ , the integrals in 20.5.3 vanish, and the normalization is therefore impossible. In applications, the particular normalization adopted is of little importance, except possibly for obtaining quantitative relations between solutions of various types. For this reason the normalization of  $F_\nu(z)$ , for arbitrary complex values of  $a, q$ , will not be specified here. It is worth noting, however, that solutions

$$\alpha ce_r(z, q), \quad \beta se_r(z, q)$$

defined so that

$$\alpha ce_r(0, q) = 1; \quad \left[ \frac{d}{dz} \beta se_r(z, q) \right]_{z=0} = 1$$

are always possible. This normalization has in fact been used in [20.59], and also in [20.58], where the most extensive tabular material is available. The tabulated entries in [20.58] supply the conversion factors  $A=1/\alpha$ ,  $B=1/\beta$ , along with the coefficients. Thus conversion from one normalization to another is rather easy.

In a similar vein, no general normalization will be imposed on the functions defined in 20.4.8.

20.6. Solutions of Mathieu's Modified Equation 20.1.2 for Integral  $\nu$  (Radial Solutions)

Solutions of the first kind

20.6.1

$$Ce_{2r+p}(z, q) = ce_{2r+p}(iz, q)$$

$$= \sum_{k=0}^{\infty} A_{2k+p}^2(q) \cosh(2k+p)z$$

associated with  $a_r$

**20.6.2**  $Se_{2r+p}(z, q) = -ise_{2r+p}(iz, q) = \sum_{k=0}^{\infty} B_{2k+p}^{2r+p}(q) \sinh(2k+p)z$ , associated with  $b_r$   
 writing  $A_{2k+p}^{2r+p}(q) = A_{2k+p}$  for brevity; similarly for  $B_{2k+p}$ ;  $p=0, 1$ ,

**20.6.3** 
$$Ce_{2r}(z, q) = \frac{ce_{2r}\left(\frac{\pi}{2}, q\right)}{A_0^{2r}} \sum_{k=0}^{\infty} (-1)^k A_{2k} J_{2k}(2\sqrt{q} \cosh z) = \frac{ce_{2r}(0, q)}{A_0^{2r}} \sum_{k=0}^{\infty} A_{2k} J_{2k}(2\sqrt{q} \sinh z)$$

**20.6.4** 
$$Ce_{2r+1}(z, q) = \frac{ce'_{2r+1}\left(\frac{\pi}{2}, q\right)}{\sqrt{q}A_1^{2r+1}} \sum_{k=0}^{\infty} (-1)^{k+1} A_{2k+1} J_{2k+1}(2\sqrt{q} \cosh z)$$

$$= \frac{ce'_{2r+1}(0, q)}{\sqrt{q}A_1^{2r+1}} \coth z \sum_{k=0}^{\infty} (2k+1) A_{2k+1} J_{2k+1}(2\sqrt{q} \sinh z)$$

**20.6.5** 
$$Se_{2r}(z, q) = \frac{se'_{2r}\left(\frac{\pi}{2}, q\right) \tanh z}{qB_2^{2r}} \sum_{k=1}^{\infty} (-1)^k 2k B_{2k} J_{2k}(2\sqrt{q} \cosh z)$$

$$= \frac{se'_{2r}(0, q)}{qB_2^{2r}} \coth z \sum_{k=1}^{\infty} 2k B_{2k} J_{2k}(2\sqrt{q} \sinh z)$$

**20.6.6** 
$$Se_{2r+1}(z, q) = \frac{se_{2r+1}\left(\frac{\pi}{2}, q\right) \tanh z}{\sqrt{q}B_1^{2r+1}} \sum_{k=0}^{\infty} (-1)^k (2k+1) B_{2k+1} J_{2k+1}(2\sqrt{q} \cosh z)$$

$$= \frac{se'_{2r+1}(0, q)}{\sqrt{q}B_1^{2r+1}} \sum_{k=0}^{\infty} B_{2k+1} J_{2k+1}(2\sqrt{q} \sinh z)$$

See [20.30] for still other forms.

Solutions of the second kind, as well as solutions of the third and fourth kind (analogous to Hankel functions) are obtainable from 20.4.12.

**20.6.7** 
$$Mc_{2r}^{(j)}(z, q) = \sum_{k=0}^{\infty} (-1)^{r+k} A_{2k}^{2r}(q) [J_{k-s}(u_1) Z_{k+s}^{(j)}(u_2) + J_{k+s}(u_1) Z_{k-s}^{(j)}(u_2)] / \epsilon_s A_{2s}^{2r}$$
  
 where  $\epsilon_0=2, \epsilon_s=1$ , for  $s=1, 2, \dots$ ;  $s$  arbitrary, associated with  $a_{2r}$

**20.6.8** 
$$Mc_{2r+1}^{(j)}(z, q) = \sum_{k=0}^{\infty} (-1)^{r+k} A_{2k+1}^{2r+1}(q) [J_{k-s}(u_1) Z_{k+s+1}^{(j)}(u_2) + J_{k+s+1}(u_1) Z_{k-s}^{(j)}(u_2)] / A_{2s+1}^{2r+1}$$
  
 associated with  $a_{2r+1}$

**20.6.9** 
$$Ms_{2r}^{(j)}(z, q) = \sum_{k=1}^{\infty} (-1)^{k+r} B_{2k}^{2r}(q) [J_{k-s}(u_1) Z_{k+s}^{(j)}(u_2) - J_{k+s}(u_1) Z_{k-s}^{(j)}(u_2)] / B_{2s}^{2r}$$
, associated with  $b_{2r}$

**20.6.10** 
$$Ms_{2r+1}^{(j)}(z, q) = \sum_{k=0}^{\infty} (-1)^{k+r} B_{2k+1}^{2r+1}(q) [J_{k-s}(u_1) Z_{k+s+1}^{(j)}(u_2) - J_{k+s+1}(u_1) Z_{k-s}^{(j)}(u_2)] / B_{2s+1}^{2r+1}$$
  
 associated with  $b_{2r+1}$

where

$$u_1 = \sqrt{q}e^{-z}, u_2 = \sqrt{q}e^z, B_{2s+p}^{2r+p}, A_{2s+p}^{2r+p} \neq 0, p=0, 1.$$

See 20.4.7 for definition of  $Z_m^{(j)}(x)$ .

Solutions 20.6.7–20.6.10 converge for all values of  $z$ , when  $q \neq 0$ . If  $j=2, 3, 4$  the logarithmic terms entering into the Bessel functions  $Y_m(u_2)$  must be defined, to make the functions single-valued. This can be accomplished as follows:

Define (as in [20.58])

**20.6.11** 
$$\ln(\sqrt{q}e^z) = \ln(\sqrt{q}) + z$$

See [20.15] and [20.36], section 2.75 for derivation.



Other Expressions for the Radial Functions (Valid Over More Limited Regions)

20.6.12 
$$Mc_{2r}^{(j)}(z, q) = [ce_{2r}(0, q)]^{-1} \sum_{k=0}^{\infty} (-1)^{k+r} A_{2k}^{2r}(q) Z_{2k}^{(j)}(2\sqrt{q} \cosh z)$$

$$Ms_{2r+1}^{(j)}(z, q) = [ce_{2r+1}(0, q)]^{-1} \sum_{k=0}^{\infty} (-1)^{k+r} A_{2k+1}^{2r+1}(q) Z_{2k+1}^{(j)}(2\sqrt{q} \cosh z)$$

20.6.13 
$$Ms_{2r}^{(j)}(z, q) = [se'_{2r}(0, q)]^{-1} \tanh z \sum_{k=1}^{\infty} (-1)^{k+r} 2k B_{2k}^{2r}(q) Z_{2k}^{(j)}(2\sqrt{q} \cosh z)$$

$$Ms_{2r+1}^{(j)}(z, q) = [se'_{2r+1}(0, q)]^{-1} \tanh z \sum_{k=0}^{\infty} (-1)^{k+r} (2k+1) B_{2k+1}^{2r+1}(q) Z_{2k+1}^{(j)}(2\sqrt{q} \cosh z)$$

Valid for  $\Re z > 0, |\cosh z| > 1$ ; if  $j=1$ , valid for all  $z$ . They agree with 20.6.7–20.6.10 if the Bessel functions  $Y_m(2q^{\frac{1}{2}} \cosh z)$  are made single-valued in a suitable way. For example, let

$$Y_m(u) = \frac{2}{\pi} (\ln u) J_m(u) + \phi(u)$$

where  $\phi(u)$  is single-valued for all finite values of  $u$ . With  $u = 2q^{\frac{1}{2}} \cosh z$ , define

20.6.14 
$$\ln(2q^{\frac{1}{2}} \cosh z) = \ln 2q^{\frac{1}{2}} + z + \ln \frac{1}{2}(1 + e^{-2z}) \quad -\frac{\pi}{2} \leq \arg \frac{1}{2}(1 + e^{-2z}) \leq \frac{\pi}{2}$$

(If  $q$  is not positive, the phase of  $\ln 2q^{\frac{1}{2}}$  must also be specified, although this specification will not affect continuity with respect to  $z$ . If  $Y_m(u)$  is defined from some other expression, the definition must be compatible with 20.6.14.)

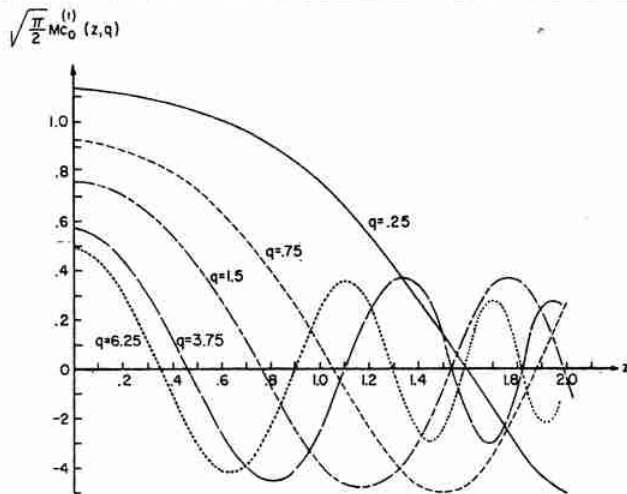

FIGURE 20.11. Radial Mathieu Function of the First Kind. (From J. C. Wiltse and M. J. King, Values of the Mathieu functions, The Johns Hopkins Univ. Radiation Laboratory Tech. Rept. AF-53, 1958, with permission)

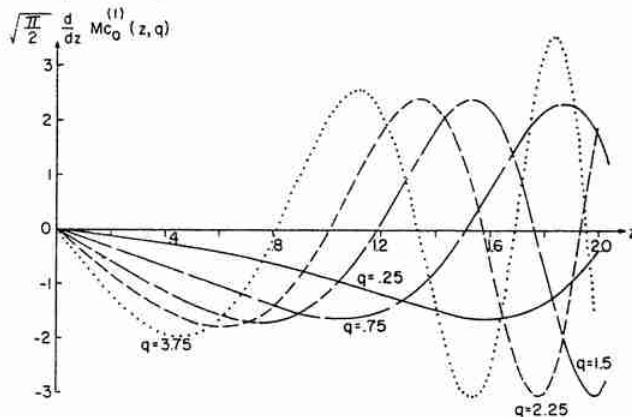

FIGURE 20.12. Derivative of the Radial Mathieu Function of the First Kind. (From J. C. Wiltse and M. J. King, Derivatives, zeros, and other data pertaining to Mathieu functions, The Johns Hopkins Univ. Radiation Laboratory Tech. Rept. AF-57, 1958, with permission)

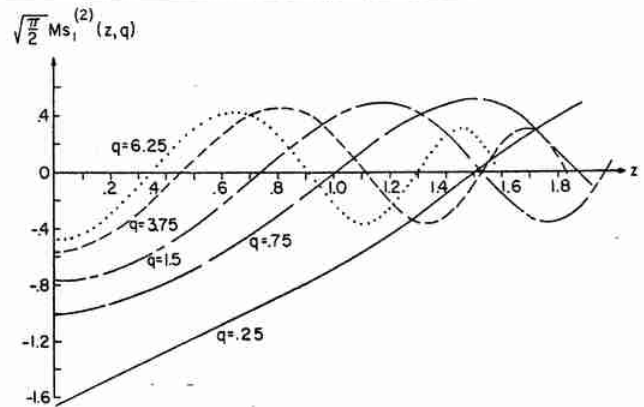

FIGURE 20.13. Radial Mathieu Function of the Second Kind. (From J. C. Wiltse and M. J. King, Values of the Mathieu functions, The Johns Hopkins Univ. Radiation Laboratory Tech. Rept. AF-53, 1958, with permission)

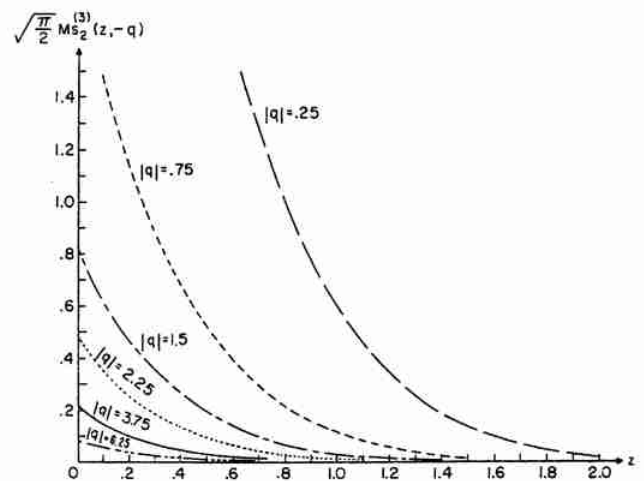

FIGURE 20.14. Radial Mathieu Function of the Third Kind. (From J. C. Wiltse and M. J. King, Values of the Mathieu functions, The Johns Hopkins Univ. Radiation Laboratory Tech. Rept. AF-53, 1958, with permission)

If  $j=1$ ,  $Mc_{2r+p}^{(1)}$  and  $Ms_{2r+p}^{(1)}$ ,  $p=0, 1$  are solutions of the first kind, proportional to  $Ce_{2r+p}$  and  $Se_{2r+p}$ , respectively.

Thus

20.6.15

$$Ce_{2r}(z, q) = \frac{ce_{2r}\left(\frac{\pi}{2}, q\right) ce_{2r}(0, q)}{(-1)^r A_2^{2r}} Mc_{2r}^{(1)}(z, q)$$

$$Ce_{2r+1}(z, q) = \frac{ce'_{2r+1}\left(\frac{\pi}{2}, q\right) ce_{2r+1}(0, q)}{(-1)^{r+1} \sqrt{q} A_1^{2r+1}} Mc_{2r+1}^{(1)}(z, q)$$

$$Se_{2r}(z, q) = \frac{se'_{2r}(0, q) se_{2r}\left(\frac{\pi}{2}, q\right)}{(-1)^r q B_2^{2r}} Ms_{2r}^{(1)}(z, q)$$

$$Se_{2r+1}(z, q) = \frac{se'_{2r+1}(0, q) se_{2r+1}\left(\frac{\pi}{2}, q\right)}{(-1)^r \sqrt{q} B_1^{2r+1}} Ms_{2r+1}^{(1)}(z, q)$$

The Mathieu-Hankel functions are

20.6.16

$$M_r^{(3)}(z, q) = M_r^{(1)}(z, q) + iM_r^{(2)}(z, q)$$

$$M_r^{(4)}(z, q) = M_r^{(1)}(z, q) - iM_r^{(2)}(z, q)$$

$$M_r^{(j)} = Mc_r^{(j)} \text{ or } Ms_r^{(j)}$$

From 20.6.7-20.6.11 and the known properties of Bessel functions one obtains

20.6.17

$$M_{2r+p}^{(2)}(z + in\pi, q) = (-1)^{np} [M_{2r+p}^{(2)}(z, q) + 2niM_{2r+p}^{(1)}(z, q)]$$

$$M_{2r+p}^{(3)}(z + in\pi, q) = (-1)^{np} [M_{2r+p}^{(3)}(z, q) - 2nM_{2r+p}^{(1)}(z, q)]$$

$$M_{2r+p}^{(4)}(z + in\pi, q) = (-1)^{np} [M_{2r+p}^{(4)}(z, q) + 2nM_{2r+p}^{(1)}(z, q)]$$

where  $M = Mc$  or  $Ms$  throughout any of the above equations.

Other Properties of Characteristic Functions,  $q$  Real (Associated With  $a$ , and  $b$ .)

Consider

20.6.18

$$X_1 = Mc_r^{(2)}(z, q) + Mc_r^{(2)}(-z, q);$$

$$X_2 = Ms_r^{(2)}(z, q) - Ms_r^{(2)}(-z, q)$$

Since  $X_1$  is an even solution it must be proportional to  $Mc_r^{(1)}(z, q)$ ; for 20.1.2 admits of only one even solution (aside from an arbitrary constant factor). Similarly,  $X_2$  is proportional to  $Ms_r^{(1)}(z, q)$ . The proportionality factors can be found by considering values of the functions at  $z=0$ . Define, therefore,

20.6.19

$$Mc_r^{(2)}(-z, q) = -Mc_r^{(2)}(z, q) - 2f_{e,r} Mc_r^{(1)}(z, q)$$

20.6.20

$$Ms_r^{(2)}(-z, q) = Ms_r^{(2)}(z, q) - 2f_{o,r} Ms_r^{(1)}(z, q)$$

where

20.6.21

$$f_{e,r} = -Mc_r^{(2)}(0, q) / Mc_r^{(1)}(0, q)$$

$$f_{o,r} = \left[ \frac{d}{dz} Ms_r^{(2)}(z, q) / \frac{d}{dz} Ms_r^{(1)}(z, q) \right]_{z=0}$$

See [20.58].

In particular the above equations can be used to extend solutions of 20.6.12-20.6.13 when  $\Re z < 0$ . For although the latter converge for  $\Re z < 0$ , provided only  $|\cosh z| > 1$ , they do not represent the same functions as 20.6.9-20.6.10.

20.7. Representations by Integrals and Some Integral Equations

Let

20.7.1 
$$G(u) = \oint_C K(u, t) V(t) dt$$

be defined for  $u$  in a domain  $U$  and let the contour  $C$  belong to the region  $T$  of the complex  $t$ -plane, with  $t=\gamma_0$  as the starting point of the contour and  $t=\gamma_1$  as its end-point. The kernel  $K(u, t)$  and the function  $V(t)$  satisfy 20.7.3 and the hypotheses in 20.7.2.

20.7.2  $K(u, t)$  and its first two partial derivatives with respect to  $u$  and  $t$  are continuous for  $t$  on  $C$  and  $u$  in  $U$ ;  $V$  and  $\frac{dV}{dt}$  are continuous in  $t$ .

20.7.3

$$\left[ \frac{\partial K}{\partial t} V - \frac{dV}{dt} K \right]_{\gamma_0}^{\gamma_1} = 0; \frac{d^2 V}{dt^2} + (a - 2q \cos 2t) V = 0.$$

If  $K$  satisfies

20.7.4 
$$\frac{\partial^2 K}{\partial u^2} + \frac{\partial^2 K}{\partial t^2} + 2q(\cosh 2u - \cos 2t) K = 0$$

then  $G(u)$  is a solution of Mathieu's modified equation 20.1.2.

If  $K(u, t)$  satisfies

20.7.5 
$$\frac{\partial^2 K}{\partial u^2} + \frac{\partial^2 K}{\partial t^2} + 2q(\cos 2u - \cos 2t) K = 0$$

then  $G(u)$  is a solution of Mathieu's equation 20.1.1, with  $u$  replacing  $v$ .



**Kernels  $K_1(z, t)$  and  $K_2(z, t)$**

**20.7.6**  $K_1(z, t) = Z_\nu^{(j)}(u)[M(z, t)]^{-\nu/2}, \quad (\Re z > 0)$

where

**20.7.7**  $u = \sqrt{2q(\cosh 2z + \cos 2t)}$

**20.7.8**  $M(z, t) = \cosh(z + it) / \cosh(z - it)$

To make  $M^{-1/\nu}$  single-valued, define

**20.7.9**

$$\begin{aligned} \cosh(z + i\pi) &= e^{i\pi} \cosh z \\ \cosh(z - i\pi) &= e^{-i\pi} \cosh z \\ M(z, 0) &= 1 \\ [M(z, \pi)]^{-1/\nu} &= e^{-i\pi} M(z, 0) \end{aligned}$$

Let

**20.7.10**  $G(z, q) = \frac{1}{\pi} \int_0^\pi K_1(u, t) F_\nu(t) dt, \quad (\Re z > 0)$

where  $F_\nu(t)$  is defined in **20.3.8**. It may be verified that  $K_1 F_\nu$  satisfies **20.7.3**,  $K$  satisfies **20.7.2** and **20.7.4**. Hence  $G$  is a solution of **20.1.2** (with  $z$  replacing  $u$ ). It can be shown that  $K_1$  may be replaced by the more general function

**20.7.11**

$K_2(z, t) = Z_\nu^{(j)}{}_{+2s}(u)[M(z, t)]^{-1/\nu+s}, \quad s \text{ any integer.}$

See **20.4.7** for definition of  $Z_\nu^{(j)}{}_{+2s}(u)$ .

From the known expansions for  $Z_\nu^{(j)}{}_{+2s}(u)$  when  $\Re z$  is large and positive it may be verified that

**20.7.12**

$M_\nu^{(j)}(z, q) =$

$$\frac{(-1)^s}{\pi c_{2s}} \int_0^\pi Z_\nu^{(j)}{}_{+2s}(u) \left[ \frac{\cosh z + it}{\cosh z - it} \right]^{-1/\nu+s} F_\nu(t) dt$$

$(\Re z > 0, \Re(\nu + \frac{1}{2}) > 0)$

where  $M_\nu^{(j)}(z, q)$  is given by **20.4.12**,  $s=0, 1, \dots, c_{2s} \neq 0$ , and  $F_\nu(t)$  is the Floquet solution, **20.3.8**.

**Kernel  $K_3(z, t, a)$**

**20.7.13**  $K_3(z, t, a) = e^{2i\sqrt{q}w}$

where

**20.7.14**  $w = \cosh z \cos a \cos t + \sinh z \sin a \sin t$

**20.7.15**  $G(z, q, a) = \frac{1}{\pi} \int_C e^{2i\sqrt{q}w} F_\nu(t) dt$

where  $F_\nu(t)$  is the Floquet solution **20.3.8**. The path  $C$  is chosen so that  $G(z, t, a)$  exists, and **20.7.2**, **20.7.3** are satisfied. Then it may be verified that  $K_3(z, t, a)$ , considered as a function of  $z$  and  $t$ , satisfies **20.7.4**; also, considered as a function of  $a$  and  $t$ ,  $K_3$  satisfies **20.7.5**. Consequently  $G(z, q, a) = Y(z, q)y(a, q)$ , where  $Y$  and  $y$  satisfy **20.1.2** and **20.1.1**, respectively.

*Choice of Path  $C$ .* Three paths will be defined:

**20.7.16**

Path  $C_3$ : from  $-d_1 + i\infty$  to  $d_2 - i\infty$ ,  $d_1, d_2$  real

$-d_1 < \arg[\sqrt{q}\{\cosh(z + ia) \pm 1\}] < \pi - d_1$

$-d_2 < \arg[\sqrt{q}\{\cosh(z - ia) \pm 1\}] < \pi - d_2$

**20.7.17**

Path  $C_4$ : from  $d_2 - i\infty$  to  $2\pi + i\infty - d_1$

(same  $d_1, d_2$  as in **20.7.16**)

**20.7.18**

$$F_\nu(a)M_\nu^{(j)}(z, q) = \frac{e^{-i\nu\frac{\pi}{2}}}{\pi} \int_{C_j} e^{2i\sqrt{q}w} F_\nu(t) dt \quad j=3, 4$$

where  $M_\nu^{(j)}(z, q)$  is also given by **20.4.12**.

**20.7.19** Path  $C_1$ : from  $-d_1 + i\infty$  to  $2\pi - d_1 + i\infty$

$$F_\nu(a)M_\nu^{(1)}(z, q) = \frac{e^{-i\nu\frac{\pi}{2}}}{2\pi} \int_{C_1} e^{2i\sqrt{q}w} F_\nu(t) dt$$

See [20.36], section **2.68**.

If  $\nu$  is an integer the paths can be simplified; for in that case  $F_\nu(t)$  is periodic and the integrals exist when the path is taken from 0 to  $2\pi$ . Still further simplifications are possible, if  $z$  is also real.

The following are among the more important integral representations for the periodic functions  $ce_r(z, q)$ ,  $se_r(z, q)$  and for the associated radial solutions.

Let  $r = 2s + p$ ,  $p = 0$  or  $1$

**20.7.20**

$$ce_r(z, q) = \rho_r \int_0^{\pi/2} \cos\left(2\sqrt{q} \cos z \cos t - p\frac{\pi}{2}\right) ce_r(t, q) dt$$

20.7.21  $ce_r(z, q) = \sigma_r \int_0^{\pi/2} \cosh(2\sqrt{q} \sin z \sin t) [(1-p) + p \cos z \cos t] ce_r(t, q) dt$

20.7.22  $se_r(z, q) = \rho_r \int_0^{\pi/2} \sin\left(2\sqrt{q} \cos z \cos t + p \frac{\pi}{2}\right) \sin z \sin t se_r(t, q) dt$

20.7.23  $se_r(z, q) = \sigma_r \int_0^{\pi/2} \sinh(2\sqrt{q} \sin z \sin t) [(1-p) \cos z \cos t + p] se_r(t, q) dt$

where

20.7.24  $\rho_r = \frac{2}{\pi} ce_{2s}\left(\frac{\pi}{2}, q\right) / A_0^{2s}(q); p=0, \rho_r = \frac{-2}{\pi} ce'_{2s+1}\left(\frac{\pi}{2}, q\right) / \sqrt{q} A_1^{2s+1}(q)$  if  $p=1$ , for functions  $ce_r(z, q)$

$\rho_r = \frac{-4}{\pi} se'_{2s}\left(\frac{\pi}{2}, q\right) / \sqrt{q} B_2^{2s}(q); \rho_r = \frac{4}{\pi} se_{2s+1}\left(\frac{\pi}{2}, q\right) / B_1^{2s+1}(q)$ , for functions  $se_r(z, q)$

$\sigma_r = \frac{2}{\pi} ce_{2s}(0, q) / A_0^{2s}(q)$  if  $p=0$ ;  $\sigma_r = \frac{4}{\pi} ce_{2s+1}(0, q) / A_1^{2s+1}(q)$ , if  $p=1$ ; associated with functions  $ce_r(z, q)$

$\sigma_r = \frac{4}{\pi} se'_{2s}(0, q) / \sqrt{q} B_2^{2s}(q)$ , if  $p=0$ ;  $\sigma_r = \frac{2}{\pi} se'_{2s+1}(0, q) / \sqrt{q} B_1^{2s+1}(q)$ , if  $p=1$ ; associated with  $se_r(z, q)$

**Integrals Involving Bessel Function Kernels**

Let

20.7.25  $u = \sqrt{2q}(\cosh 2z + \cos 2t)$ , ( $\mathcal{R} \cosh 2z > 1$ ; if  $j=1$ , valid also when  $z=0$ )

20.7.26

$Mc_{2r}^{(j)}(z, q) = \frac{(-1)^r 2}{\pi A_0^{2r}} \int_0^{\frac{\pi}{2}} Z_0^{(j)}(u) ce_{2r}(t, q) dt; Mc_{2r+1}^{(j)}(z, q) = \frac{(-1)^r 8\sqrt{q} \cosh z}{\pi A_1^{2r+1}} \int_0^{\frac{\pi}{2}} \frac{Z_1^{(j)}(u) \cos t}{u} ce_{2r+1}(t, q) dt$

20.7.27

$Ms_{2r}^{(j)}(z, q) = \frac{(-1)^{r+1} 8q \sinh 2z}{\pi B_2^{2r}} \int_0^{\frac{\pi}{2}} \frac{Z_2^{(j)}(u) \sin 2t se_{2r}(t, q) dt}{u^2}$

$Ms_{2r+1}^{(j)}(z, q) = \frac{(-1)^r 8\sqrt{q} \sinh z}{\pi B_1^{2r+1}} \int_0^{\frac{\pi}{2}} \frac{Z_1^{(j)}(u) \sin t se_{2r+1}(t, q) dt}{u}$

In the above the  $j$ -convention of 20.4.7 applies and the functions  $Mc, Ms$  are defined in 20.5.1-20.5.4. (These solutions are normalized so that they approach the corresponding Bessel-Hankel functions as  $\mathcal{R}z \rightarrow \infty$ .)

**Other Integrals for  $Mc_r^{(1)}(z, q)$  and  $Ms_r^{(1)}(z, q)$**

20.7.28  $Mc_r^{(1)}(z, q) = \frac{(-1)^{s2}}{\pi ce_r(0, q)} \int_0^{\frac{\pi}{2}} \cos\left(2\sqrt{q} \cosh z \cos t - p \frac{\pi}{2}\right) ce_r(t, q) dt$

20.7.29  $Mc_r^{(1)}(z, q) = \tau_r \int_0^{\frac{\pi}{2}} [(1-p) + p \cosh z \cos t] \cos(2\sqrt{q} \sinh z \sin t) ce_r(t, q) dt$

$r=2s+p, p=0, 1; \tau_r = \frac{2}{\pi} (-1)^s / ce_{2s}\left(\frac{\pi}{2}, q\right)$ , if  $p=0$ ;  $\tau_r = \frac{2}{\pi} (-1)^{s+1} 2\sqrt{q} / ce'_{2s+1}\left(\frac{\pi}{2}, q\right)$

20.7.30  $Ms_{2r+1}^{(1)}(z, q) = \frac{2}{\pi} \frac{(-1)^r}{se_{2r+1}\left(\frac{\pi}{2}, q\right)} \int_0^{\frac{\pi}{2}} \sin(2\sqrt{q} \sinh z \sin t) se_{2r+1}(t, q) dt$

20.7.31  $Ms_{2r+1}^{(1)}(z, q) = \frac{4}{\pi} \frac{\sqrt{q}(-1)^r}{se'_{2r+1}(0, q)} \int_0^{\frac{\pi}{2}} \sinh z \sin t \cos(2\sqrt{q} \cosh z \cos t) se_{2r+1}(t, q) dt$

20.7.32  $Ms_{2r}^{(1)}(z, q) = \frac{4}{\pi} \sqrt{q} \frac{(-1)^{r+1}}{se'_{2r}(0, q)} \int_0^{\frac{\pi}{2}} \sin(2\sqrt{q} \cosh z \cos t) [\sinh z \sin t se_{2r}(t, q)] dt$

20.7.33  $Ms_{2r}^{(1)}(z, q) = \frac{4}{\pi} \frac{(-1)^r \sqrt{q}}{se'_{2r}\left(\frac{\pi}{2}, q\right)} \int_0^{\frac{\pi}{2}} \sin(2\sqrt{q} \sinh z \sin t) [\cosh z \cos t se_{2r}(t, q)] dt$

Further with  $w = \cosh z \cos \alpha \cos t + \sinh z \sin \alpha \sin t$

$$20.7.34 \quad ce_r(\alpha, q) Mc_r^{(1)}(z, q) = \frac{(-1)^s(i)^{-p}}{2\pi} \int_0^{2\pi} e^{2i\sqrt{q}w} ce_r(t, q) dt$$

$$20.7.35 \quad se_r(\alpha, q) Ms_r^{(1)}(z, q) = \frac{(-1)^s(-i)^p}{2\pi} \int_0^{2\pi} e^{2i\sqrt{q}w} se_r(t, q) dt.$$

The above can be differentiated with respect to  $\alpha$ , and we obtain

$$20.7.36 \quad ce'_r(\alpha, q) Mc_r^{(1)}(z, q) = \frac{(-1)^s(i)^{-p+1}\sqrt{q}}{\pi} \int_0^{2\pi} e^{2i\sqrt{q}w} \frac{\partial w}{\partial \alpha} ce_r(t, q) dt$$

$$20.7.37 \quad se'_r(\alpha, q) Ms_r^{(1)}(z, q) = \frac{(-1)^{s+p}(i)^{-p+1}\sqrt{q}}{\pi} \int_0^{2\pi} e^{2i\sqrt{q}w} \frac{\partial w}{\partial \alpha} se_r(t, q) dt$$

#### Integrals With Infinite Limits

$$r = 2s + p$$

In 20.7.38–20.7.41 below,  $z$  and  $q$  are positive.

$$20.7.38 \quad Mc_r^{(1)}(z, q) = \gamma_r \int_0^\infty \sin \left( 2\sqrt{q} \cosh z \cosh t + p \frac{\pi}{2} \right) Mc_r^{(1)}(t, q) dt$$

$$\gamma_r = 2ce'_{2s} \left( \frac{\pi}{2}, q \right) / \pi A_0^{2s}, \text{ if } p=0 \quad \gamma_r = 2ce'_{2s+1} \left( \frac{\pi}{2}, q \right) / \sqrt{q} \pi A_1^{2s+1}, \text{ if } p=1$$

$$20.7.39 \quad Ms_r^{(1)}(z, q) = \gamma_r \int_0^\infty \sinh z \sinh t \left[ \cos \left( 2\sqrt{q} \cosh z \cosh t - p \frac{\pi}{2} \right) \right] Ms_r^{(1)}(t, q) dt$$

$$\gamma_r = -4se'_{2s} \left( \frac{\pi}{2}, q \right) / \sqrt{q} \pi B_2^{2s}, \text{ if } p=0 \quad \gamma_r = -4se'_{2s+1} \left( \frac{\pi}{2}, q \right) / \pi B_1^{2s+1}, \text{ if } p=1$$

$$20.7.40 \quad Mc_r^{(2)}(z, q) = \gamma_r \int_0^\infty \cos \left( 2\sqrt{q} \cosh z \cosh t - p \frac{\pi}{2} \right) Mc_r^{(1)}(t, q) dt$$

$$\gamma_r = -2ce'_{2s}(\frac{1}{2}\pi, q) / \pi A_0^{2s}, \text{ if } p=0 \quad \gamma_r = 2ce'_{2s+1}(\frac{1}{2}\pi, q) / \pi \sqrt{q} A_1^{2s+1}, \text{ if } p=1$$

$$20.7.41 \quad Ms_r^{(2)}(z, q) = \gamma_r \int_0^\infty \sin \left( 2\sqrt{q} \cosh z \cosh t + p \frac{\pi}{2} \right) \sinh z \sinh t Ms_r^{(1)}(t, q) dt$$

$$\gamma_r = -4se'_{2s}(\frac{1}{2}\pi, q) / \sqrt{q} \pi B_2^{2s}, \text{ if } p=0 \quad \gamma_r = 4se'_{2s+1}(\frac{1}{2}\pi, q) / \pi B_1^{2s+1}, \text{ if } p=1$$

Additional forms in [20.30], [20.36], [20.15].

#### 20.8. Other Properties

Relations Between Solutions for Parameters  $q$  and  $-q$

Replacing  $z$  by  $\frac{1}{2}\pi - z$  in 20.1.1 one obtains

$$20.8.1 \quad y'' + (a + 2q \cos 2z)y = 0$$

Hence if  $u(z)$  is a solution of 20.1.1 then  $u(\frac{1}{2}\pi - z)$  satisfies 20.8.1. It can be shown that

#### 20.8.2

$$a(-\nu, q) = a(\nu, -q) = a(\nu, q), \nu \text{ not an integer}$$

$$c_{2m}^*(-q) = \rho(-1)^m c_{2m}^*(q), \nu \text{ not an integer}$$

( $c_{2m}$  defined in 20.3.8) and  $\rho$  depending on the normalization;

$$F_\nu(z, -q) = \rho e^{-i\nu\pi/2} F_\nu \left( z + \frac{\pi}{2}, q \right) = \rho e^{i\nu\pi/2} F_\nu \left( z - \frac{\pi}{2}, q \right)$$

20.8.3

$$a_{2r}(-q) = a_{2r}(q); b_{2r}(-q) = b_{2r}(q), \text{ for integral } \nu$$

$$a_{2r+1}(-q) = b_{2r+1}(q), b_{2r+1}(-q) = a_{2r+1}(q)$$

20.8.4

$$ce_{2r}(z, -q) = (-1)^r ce_{2r}(\frac{1}{2}\pi - z, q)$$

$$se_{2r+1}(z, -q) = (-1)^r se_{2r+1}(\frac{1}{2}\pi - z, q)$$

$$se_{2r+1}(z, -q) = (-1)^r ce_{2r+1}(\frac{1}{2}\pi - z, q)$$

$$se_{2r}(z, -q) = (-1)^{r-1} se_{2r}(\frac{1}{2}\pi - z, q)$$

For the coefficients associated with the above solutions for integral  $\nu$ :

20.8.5

$$A_{2m}^{2r}(-q) = (-1)^{m-r} A_{2m}^{2r}(q);$$

$$B_{2m}^{2r}(-q) = (-1)^{m-r} B_{2m}^{2r}(q)$$

$$A_{2m+1}^{2r+1}(-q) = (-1)^{m-r} B_{2m+1}^{2r+1}(q);$$

$$B_{2m+1}^{2r+1}(-q) = (-1)^{m-r} A_{2m+1}^{2r+1}(q).$$

For the corresponding modified equation

20.8.6  $y'' - (a + 2q \cosh 2z)y = 0$

20.8.7

$$M_\nu^{(j)}(z, -q) = M_\nu^{(j)}\left(z + i\frac{\pi}{2}, q\right),$$

$$M_\nu^{(j)}(z, q) \text{ defined in 20.4.12.}$$

For integral values of  $\nu$  let

20.8.8

$$Ie_{2r}(z, q) = \sum_{k=0}^{\infty} (-1)^{k+s} A_{2k} [I_{k-s}(u_1) I_{k+s}(u_2) + I_{k+s}(u_1) I_{k-s}(u_2)] / A_{2s} \epsilon_s$$

$$Io_{2r}(z, q) = \sum_{k=1}^{\infty} (-1)^{k+s} B_{2k} [I_{k-s}(u_1) I_{k+s}(u_2) - I_{k+s}(u_1) I_{k-s}(u_2)] / B_{2s}$$

$$Ie_{2r+1}(z, q) = \sum_{k=0}^{\infty} (-1)^{k+s} B_{2k+1} [I_{k-s}(u_1) I_{k+s+1}(u_2) + I_{k+s+1}(u_1) I_{k-s}(u_2)] / B_{2s+1}$$

$$Io_{2r+1}(z, q) = \sum_{k=0}^{\infty} (-1)^{k+s} A_{2k+1} [I_{k-s}(u_1) I_{k+s+1}(u_2) - I_{k+s+1}(u_1) I_{k-s}(u_2)] / A_{2s+1}$$

20.8.9

$$Ke_{2r}(z, q) = \sum_{k=0}^{\infty} A_{2k} [I_{k-s}(u_1) K_{k+s}(u_2) + I_{k+s}(u_1) K_{k-s}(u_2)] / A_{2s} \epsilon_s$$

$$* Ko_{2r}(z, q) = \sum_{k=0}^{\infty} B_{2k} [I_{k-s}(u_1) K_{k+s}(u_2) - I_{k+s}(u_1) K_{k-s}(u_2)] / B_{2s}$$

$$* Ke_{2r+1}(z, q) = \sum_{k=0}^{\infty} B_{2k+1} [I_{k-s}(u_1) K_{k+s+1}(u_2) - I_{k+s+1}(u_1) K_{k-s}(u_2)] / B_{2s+1}$$

\*See page II.

$$Ko_{2r+1}(z, q) = \sum_{k=0}^{\infty} A_{2k+1} [I_{k-s}(u_1) K_{k+s+1}(u_2) + I_{k+s+1}(u_1) K_{k-s}(u_2)] / A_{2s+1}$$

where  $I_m(x), K_m(x)$  are the modified Bessel functions,  $u_1, u_2$  are defined below 20.6.10. Supercripts are omitted,  $\epsilon_s = 2$ , if  $s = 0$ ,  $\epsilon_s = 1$  if  $s \neq 0$ .

Then for functions of first kind:

20.8.10

$$Mc_{2r}^{(1)}(z, -q) = (-1)^r Ie_{2r}(z, q)$$

$$Ms_{2r}^{(1)}(z, -q) = (-1)^r Io_{2r}(z, q)$$

$$Mc_{2r+1}^{(1)}(z, -q) = (-1)^r i Ie_{2r+1}(z, q)$$

$$Ms_{2r+1}^{(1)}(z, -q) = (-1)^r i Io_{2r+1}(z, q)$$

For the Mathieu-Hankel function of first kind:

20.8.11

$$Mc_{2r}^{(3)}(z, -q) = (-1)^{r+i} \frac{2}{\pi} Ke_{2r}(z, q)$$

$$Ms_{2r}^{(3)}(z, -q) = (-1)^{r+i} \frac{2}{\pi} Ko_{2r}(z, q)$$

$$Mc_{2r+1}^{(3)}(z, -q) = (-1)^{r+i} \frac{2}{\pi} Ke_{2r+1}(z, q)$$

$$Ms_{2r+1}^{(3)}(z, -q) = (-1)^{r+i} \frac{2}{\pi} Ko_{2r+1}(z, q)$$

For  $M_r^{(j)}(z, -q), j = 2, 4$ , one may use the definitions

$$M_r^{(2)} = -i(M_r^{(3)} - M_r^{(1)}); M_r = Mc_r \text{ or } Ms_r,$$

also

$$M_r^{(4)}(z, -q) = 2M_r^{(1)}(z, -q) - M_r^{(3)}(z, -q)$$

$$M = Mc \text{ or } Ms; \text{ for real } z, q, M_r^{(j)}(z, -q)$$

are in general complex if  $j = 2, 4$ .

Zeros of the Functions for Real Values of  $q$ .

See [20.36], section 2.8 for further results.

Zeros of  $ce_r(z, q)$  and  $se_r(z, q), Mc_r^{(1)}(z, q), Ms_r^{(1)}(z, q)$ .

In  $0 \leq z < \pi, ce_r(z, q)$  and  $se_r(z, q)$  have  $r$  real zeros.

There are complex zeros if  $q > 0$ .

If  $z_0 = x_0 + iy_0$  is any zero of  $ce_r(z, q), se_r(z, q)$  in

$$-\frac{\pi}{2} < x_0 < \frac{\pi}{2}, \text{ then } k\pi \pm z_0, k\pi \pm \bar{z}_0$$

are also zeros,  $k$  an integer.

In the strip  $-\frac{\pi}{2} < x_0 < \frac{\pi}{2}$ , the imaginary zeros of  $ce_r(z, q)$ ,  $se_r(z, q)$  are the real zeros of  $Ce_r(z, q)$ ,  $Se_r(z, q)$ , hence also the real zeros of  $Mc_r^{(1)}(z, q)$  and  $Ms_r^{(1)}(z, q)$ , respectively.

For small  $q$ , the large zeros of  $Ce_r(z, q)$ ,  $Se_r(z, q)$  approach the zeros of  $J_r(2\sqrt{q} \cosh z)$ .

**Tabulation of Zeros**

Ince [20.56] tabulates the first "non-trivial" zero (i.e. different from  $0, \frac{\pi}{2}, \pi$ ) for  $ce_r(z)$ ,  $se_r(z)$ ,  $r=2(1)5$  and for  $se_6(z)$  to within  $\circ 10^{-4}$ , for  $q=0(1)10(2)40$ . He also gives the "turning" points (zeros of the derivative) and also expansions for them for small  $q$ . Wiltse and King [20.61,2] tabulate the first two (non-trivial) zeros of  $Mc_r^{(1)}(z, q)$  and  $Ms_r^{(1)}(z, q)$  and of their derivatives  $r=0, 1, 2$  for 6 or 7 values of  $q$  between .25 and 10. The graphs reproduced here indicate their location.

Between two real zeros of  $Mc_r^{(1)}(z, q)$ ,  $Ms_r^{(1)}(z, q)$  there is a zero of  $Mc_r^{(2)}(z, q)$ ,  $Ms_r^{(2)}(z, q)$ , respectively. No tabulation of such zeros exists yet.

Available tables are described in the References.

The most comprehensive tabulation of the characteristic values  $a_r, b_r$  (in a somewhat different notation) and of the coefficients proportional to  $A_m$  and  $B_m$  as defined in 20.5.4 and 20.5.5 can be found in [20.58]. In addition, the table contains certain important "joining factors", with the aid of which it is possible to obtain values of  $Mc_r^{(j)}(z, q)$  and  $Ms_r^{(j)}(z, q)$  as well as their derivatives, at  $x=0$ . Values of the functions  $ce_r(x, q)$  and  $se_r(x, q)$  for orders up to five or six can be found in [20.56]. Tabulations of less extensive character, but important in some aspects, are outlined in the other references cited. In this chapter only representative values of the various functions are given, along with several graphs.

**Special Values for Arguments 0 and  $\frac{\pi}{2}$**

**20.8.12**

$$ce_{2r}\left(\frac{\pi}{2}, q\right) = (-1)^r g_{e, 2r}(q) A_0^{2r}(q) \sqrt{\frac{\pi}{2}}$$

$$ce'_{2r+1}\left(\frac{\pi}{2}, q\right) = (-1)^{r+1} g_{e, 2r+1}(q) A_1^{2r+1}(q) \sqrt{\frac{\pi}{2}} q$$

$$se'_{2r}\left(\frac{\pi}{2}, q\right) = (-1)^r g_{o, 2r}(q) B_2^{2r}(q) \cdot q \sqrt{\frac{\pi}{2}}$$

$$se_{2r+1}\left(\frac{\pi}{2}, q\right) = (-1)^r g_{o, 2r+1}(q) B_1^{2r+1}(q) \sqrt{\frac{\pi}{2}} q$$

$$Mc_r^{(1)}(0, q) = \sqrt{\frac{2}{\pi}} \frac{1}{g_{e,r}(q)}$$

$$Mc_r^{(2)}(0, q) = -\sqrt{\frac{2}{\pi}} f_{e,r}(q)/g_{e,r}(q)$$

$$\frac{d}{dz} [Mc_r^{(2)}(z, q)]_{z=0} = \sqrt{\frac{2}{\pi}} g_{e,r}(q)$$

$$\frac{d}{dz} [Ms_r^{(1)}(z, q)]_{z=0} = \sqrt{\frac{2}{\pi}} \frac{1}{g_{o,r}(q)}$$

$$\frac{d}{dz} [Ms_r^{(2)}(z, q)]_{z=0} = \sqrt{\frac{2}{\pi}} f_{o,r}(q)/g_{o,r}(q)$$

$$Ms_r^{(2)}(z, q) = -g_{o,r}(q) \sqrt{\frac{2}{\pi}}$$

The functions  $f_{o,r}, g_{o,r}, f_{e,r}, g_{e,r}$  are tabulated in [20.58] for  $q \leq 25$ .

**20.9. Asymptotic Representations**

The representations given below are applicable to the characteristic solutions, for real values of  $q$ , unless otherwise noted. The Floquet exponent  $\nu$  is defined below, as in [20.36] to be as follows:

In solutions associated with  $a_r$ :  $\nu=r$

In solutions associated with  $b_r$ :  $\nu=-r$ .

For the functions defined in 20.6.7-20.6.10:

**20.9.1**

$$\begin{aligned} & Mc_r^{(3)}(z, q) \\ & (-1)^r Ms_r^{(3)}(z, q) \\ & \sim \frac{e^{i(2\sqrt{q} \cosh z - \frac{\nu\pi}{2} - \frac{\pi}{4})}}{\pi^{\frac{1}{2}} q^{1/4} (\cosh z - \sigma)^{\frac{1}{2}}} \sum_{m=0}^{\infty} \frac{D_m}{[-4i\sqrt{q}(\cosh z - \sigma)]^m} \end{aligned}$$

where  $D_{-1}=D_{-2}=0; D_0=1$ , and the coefficients  $D_m$  are obtainable from the following recurrence formula:

**20.9.2**

$$\begin{aligned} & (m+1)D_{m+1} + \left[ \left(m + \frac{1}{2}\right)^2 - \left(m + \frac{1}{4}\right) 8i\sqrt{q} \sigma \right. \\ & \left. + 2q - a \right] D_m + \left(m - \frac{1}{2}\right) [16q(1 - \sigma^2) - 8i\sqrt{q} \sigma m] D_{m-1} \\ & + 4q(2m-3)(2m-1)(1 - \sigma^2) D_{m-2} = 0 \end{aligned}$$

**20.9.3**

$$\begin{aligned} & Mc_r^{(4)}(z, q) \\ & (-1)^r Ms_r^{(4)}(z, q) \\ & \sim \frac{e^{-i[2\sqrt{q} \cosh z - \frac{1}{2}\nu\pi - \frac{1}{4}\pi]}}{\pi^{\frac{1}{2}} q^{1/4} (\cosh z - \sigma)^{\frac{1}{2}}} \sum_{m=0}^{\infty} \frac{d_m}{[4i\sqrt{q}(\cosh z - \sigma)]^m} \end{aligned}$$

$d_{-1}=d_{-2}=0; d_0=1$ , and

20.9.4

$$(m+1)d_{m+1} + \left[ \left(m + \frac{1}{2}\right)^2 + \left(m + \frac{1}{4}\right) 8i\sqrt{q}\sigma \right. \\ \left. + 2q - a \right] d_m + \left(m - \frac{1}{2}\right) [16q(1-\sigma^2) + 8i\sqrt{q}\sigma m] d_{m-1} \\ + 4q(2m-3)(2m-1)(1-\sigma^2)d_{m-2} = 0.$$

In the above

$$-2\pi < \arg \sqrt{q} \cosh z < \pi \\ |\cosh z - \sigma| > |\sigma \pm 1|, \Re z > 0,$$

but  $\sigma$  is otherwise arbitrary. If  $\sigma^2 = 1$ , 20.9.2 and 20.9.4 become three-term recurrence relations.

Formulas 20.9.1 and 20.9.3 are valid for arbitrary  $a, q$ , provided  $\nu$  is also known; they give multiples of 20.4.12, normalized so as to approach the corresponding Hankel functions  $H_\nu^{(1)}(\sqrt{q}e^z)$ ,  $H_\nu^{(2)}(\sqrt{q}e^z)$ , as  $z \rightarrow \infty$ . See [20.36], section 2.63. The formula is especially useful if  $|\cosh z|$  is large and  $q$  is not too large; thus if  $\sigma = -1$ , the absolute ratio of two successive terms in the expansion is essentially

$$\left| \left( \frac{\sqrt{q}}{m} + \frac{m}{4\sqrt{q}} + 2 \right) / (\cosh z + 1) \right|.$$

If  $a, q, z, \nu$  are real, the real and imaginary components of  $Mc_r^{(3)}(z, q)$  are  $Mc_r^{(1)}(z, q)$  and  $Mc_r^{(2)}(z, q)$ , respectively; similarly for the components of  $Ms_r^{(3)}(z, q)$ . If the parameters are complex

20.9.5  $Mc_r^{(1)}(z, q) = \frac{1}{2} [Mc_r^{(3)}(z, q) + Mc_r^{(4)}(z, q)]$

20.9.6  $Mc_r^{(2)}(z, q) = -\frac{i}{2} [Mc_r^{(3)}(z, q) - Mc_r^{(4)}(z, q)]$

Replacing  $c$  by  $s$  in the above will yield corresponding relations among  $Ms_r^{(j)}(z, q)$ .

Formulas in which the parameter  $a$  does not enter explicitly:

Goldstein's Expansions

20.9.7

$$Mc_r^{(3)}(z, q) \sim iMs_{r+}^{(3)}(z, q) \\ \approx [F_0(z) - iF_1(z)]e^{i\pi/4}q^k(\cosh z)^k$$

where

20.9.8

$$\phi = 2\sqrt{q} \sinh z - \frac{1}{2}(2r+1) \arctan \sinh z, \\ \Re z > 0, q \gg 1, w = 2r+1$$

20.9.9

$$F_0(z) \sim 1 + \frac{w}{8\sqrt{q} \cosh^2 z} \\ + \frac{1}{2048q} \left[ \frac{w^4 + 86w^2 + 105}{\cosh^4 z} - \frac{w^4 + 22w^2 + 57}{\cosh^2 z} \right] \\ + \frac{1}{16384q^{3/2}} \left[ \frac{-(w^5 + 14w^3 + 33w)}{\cosh^2 z} \right. \\ \left. - \frac{(2w^5 + 124w^3 + 1122w)}{\cosh^4 z} + \frac{3w^5 + 290w^3 + 1627w}{\cosh^6 z} \right] + \dots$$

20.9.10

$$F_1(z) \sim \frac{\sinh z}{\cosh^2 z} \left[ \frac{w^2 + 3}{32\sqrt{q}} + \frac{1}{512q} \left( w^2 + 3w + \frac{4w^3 + 44w}{\cosh^2 z} \right) \right. \\ \left. + \frac{1}{16384q^{3/2}} \left\{ 5w^4 + 34w^2 + 9 \right. \right. \\ \left. \left. - \frac{(w^6 - 47w^4 + 667w^2 + 2835)}{12 \cosh^2 z} \right. \right. \\ \left. \left. + \frac{(w^6 + 505w^4 + 12139w^2 + 10395)}{12 \cosh^4 z} \right\} \right] + \dots$$

See [20.18] for details and an added term in  $q^{-5/2}$ ; a correction to the latter is noted in [20.58].

The expansions 20.9.7 are especially useful when  $q$  is large and  $z$  is bounded away from zero. The order of magnitude of  $Mc_r^{(3)}(0, q)$  cannot be obtained from the expansion. The expansion can also be used, with some success, for  $z = ix$ , when  $q$  is large, if  $|\cos x| \gg 0$ ; they fail at  $x = \frac{1}{2}\pi$ . Thus, if  $q, x$  are real, one obtains

20.9.11

$$ce_r(x, q) \sim \frac{ce_r(0, q)2^{r-1}}{F_0(0)} \{W_1[P_0(x) - P_1(x)] \\ + W_2[P_0(x) + P_1(x)]\}$$

20.9.12

$$se_{r+1}(x, q) \sim se'_{r+1}(0, q)\tau_{r+1} \{W_1[P_0(x) - P_1(x)] \\ - W_2[P_0(x) + P_1(x)]\}$$

In the above,  $P_0(x)$  and  $P_1(x)$  are obtainable from  $F_0(z), F_1(z)$  in 20.9.9-20.9.10 by replacing  $\cosh z$  with  $\cos x$  and  $\sinh z$  with  $\sin x$ . Thus  $P_0(x) = F_0(ix); P_1(x) = -iF_1(ix)$ :

20.9.13

$$W_1 = e^{2\sqrt{q} \sin x} [\cos(\frac{1}{2}x + \frac{1}{4}\pi)]^{2r+1} / (\cos x)^{r+1}$$

$$W_2 = e^{-2\sqrt{q} \sin x} [\sin(\frac{1}{2}x + \frac{1}{4}\pi)]^{2r+1} / (\cos x)^{r+1}$$



## 20.9.14

$$\tau_{r+1} \sim 2^{r-1} \sqrt{\left[ 2\sqrt{q} - \frac{1}{4}w - \frac{(2w^2+3)}{64\sqrt{q}} - \frac{(7w^3+47w)}{1024q} - \dots \right]}$$

See 20.9.23-20.9.24 for expressions relating to  $ce_r(0, q)$  and  $se_r(0, q)$ . When  $|\cos x| > \sqrt{4r+2}/q^{\frac{1}{4}}$ , 20.9.11-20.9.12 are useful. The approximations become poorer as  $r$  increases.

## Expansions in Terms of Parabolic Cylinder Functions

(Good for angles close to  $\frac{1}{2}\pi$ , for large values of  $q$ , especially when  $|\cos x| < 2^{\frac{1}{4}}/q^{\frac{1}{4}}$ .) Due to Sips [20.44-20.46].

$$20.9.15 \quad ce_r(x, q) \sim C_r [Z_0(\alpha) + Z_1(\alpha)]$$

## 20.9.16

$$se_{r+1}(x, q) \sim S_r [Z_0(\alpha) - Z_1(\alpha)] \sin x, \quad \alpha = 2q^{\frac{1}{4}} \cos x.$$

$$\text{Let } D_k = D_k(\alpha) = (-1)^k e^{i\alpha^2} \frac{d^k}{d\alpha^k} e^{-i\alpha^2}.$$

## 20.9.17

$$\begin{aligned} Z_0(\alpha) \sim & D_r + \frac{1}{4q^{\frac{1}{4}}} \left[ -\frac{D_{r+4}}{16} + \frac{3}{2} \binom{r}{4} D_{r-4} \right] \\ & + \frac{1}{16q} \left[ \frac{D_{r+8}}{512} - \frac{(r+2)D_{r+4}}{16} + \frac{3}{2} (r-1) \binom{r}{4} D_{r-4} \right. \\ & \left. + \frac{315}{4} \binom{r}{8} D_{r-8} \right] + \dots \end{aligned}$$

## 20.9.18

$$\begin{aligned} Z_1(\alpha) \sim & \frac{1}{4q^{\frac{1}{4}}} \left[ -\frac{1}{4} D_{r+2} - \frac{r(r-1)}{4} D_{r-2} \right] \\ & + \frac{1}{16q} \left[ \frac{D_{r+6}}{64} + \frac{(r^2-25r-36)}{64} D_{r+2} \right. \\ & \left. + \frac{r(r-1)(-r^2-27r+10)}{64} D_{r-2} - \frac{45}{4} \binom{r}{6} D_{r-6} + \dots \right] \end{aligned}$$

## 20.9.19

$$\begin{aligned} C_r \sim & \left( \frac{\pi}{2} \right)^{\frac{1}{4}} q^{\frac{1}{4}} / (r!)^{\frac{1}{2}} \left[ 1 + \frac{2r+1}{8q^{\frac{1}{2}}} \right. \\ & \left. + \frac{r^4+2r^3+263r^2+262r+108}{2048q} + \frac{f_1}{16384q^{\frac{3}{2}}} + \dots \right]^{-\frac{1}{2}} \\ & f_1 = 6r^6 + 15r^4 + 1280r^3 + 1905r^2 + 1778r + 572 \end{aligned}$$

\*See page II.

## 20.9.20

$$\begin{aligned} S_r \sim & \left( \frac{\pi}{2} \right)^{\frac{1}{4}} q^{\frac{1}{4}} / (r!)^{\frac{1}{2}} \left[ 1 - \frac{2r+1}{8q^{\frac{1}{2}}} \right. \\ & \left. + \frac{r^4+2r^3-121r^2-122r-84}{2048q} + \frac{f_2}{16384q^{\frac{3}{2}}} + \dots \right]^{-\frac{1}{2}} \\ & f_2 = 2r^6 + 5r^4 - 416r^3 - 629r^2 - 1162r - 476 \end{aligned}$$

It should be noted that 20.9.15 is also valid as an approximation for  $se_{r+1}(x, q)$ , but 20.9.16 may give slightly better results. See [20.4.]

Explicit Expansions for Orders 0, 1, to Terms in  $q^{-3/2}$  ( $q$  Large)20.9.21 For  $r=0$ :

$$\begin{aligned} Z_0 \sim & D_0 - \frac{D_4}{64\sqrt{q}} + \frac{1}{16q} \left( -\frac{D_4}{8} + \frac{D_8}{512} \right) * \\ & + \frac{1}{64q^{3/2}} \left( -\frac{99D_4}{256} + \frac{3D_8}{256} - \frac{D_{12}}{24576} \right) + \dots \end{aligned}$$

$$\begin{aligned} Z_1 \sim & -\frac{D_2}{16\sqrt{q}} + \frac{1}{16q} \left( -\frac{9D_2}{16} + \frac{D_6}{64} \right) \\ & + \frac{1}{64q^{3/2}} \left( -\frac{61D_2}{32} + \frac{25D_6}{256} - \frac{5D_{10}}{10240} \right) + \dots \end{aligned}$$

20.9.22 For  $r=1$ :

$$\begin{aligned} Z_0 \sim & D_1 - \frac{D_5}{64\sqrt{q}} + \frac{1}{16q} \left( -\frac{3D_5}{16} + \frac{D_9}{512} \right) \\ & + \frac{1}{64q^{3/2}} \left( -\frac{207D_5}{256} + \frac{D_9}{64} - \frac{D_{13}}{24576} \right) + \dots \end{aligned}$$

$$\begin{aligned} Z_1 \sim & -\frac{D_3}{16\sqrt{q}} + \frac{1}{16q} \left( -\frac{15D_3}{16} + \frac{D_7}{64} \right) \\ & + \frac{1}{64q^{3/2}} \left( -\frac{153D_3}{32} + \frac{35D_7}{256} - \frac{D_{11}}{2048} \right) + \dots \end{aligned}$$

Formulas Involving  $ce_r(0, q)$  and  $se_r(0, q)$ 

## 20.9.23

$$\begin{aligned} \frac{ce_0(0, q)}{ce_0(\frac{1}{2}\pi, q)} & \sim 2\sqrt{2} e^{-2\sqrt{q}} \left( 1 + \frac{1}{16\sqrt{q}} + \frac{9}{256q} + \dots \right) \\ \frac{ce_2(0, q)}{ce_2(\frac{1}{2}\pi, q)} & \sim -32q\sqrt{2} e^{-2\sqrt{q}} \left( 1 - \frac{1}{16\sqrt{q}} + \frac{29}{128q} + \dots \right) \end{aligned}$$



$$\frac{ce_1(0, q)}{ce_1'(\frac{1}{2}\pi, q)} \sim -4\sqrt{2}e^{-2\sqrt{q}} \left(1 + \frac{3}{16\sqrt{q}} + \frac{45}{256q} + \dots\right)$$

$$\frac{ce_3(0, q)}{ce_3'(\frac{1}{2}\pi, q)} \sim \frac{64}{3} q\sqrt{2} e^{-2\sqrt{q}} \left(1 - \frac{3}{16\sqrt{q}} + \frac{47}{128q} + \dots\right)$$

**20.9.24**

$$\frac{se_1'(0, q)}{se_1(\frac{1}{2}\pi, q)} \sim 4q\sqrt{2} e^{-2\sqrt{q}} \left(1 - \frac{3}{16\sqrt{q}} - \frac{11}{256q} + \dots\right)$$

$$\frac{se_3'(0, q)}{se_3(\frac{1}{2}\pi, q)} \sim -64q\sqrt{2} e^{-2\sqrt{q}} \left(1 - \frac{21}{16\sqrt{q}} - \frac{17}{128q} + \dots\right)$$

$$\frac{se_2'(0, q)}{se_2(\frac{1}{2}\pi, q)} \sim -8q\sqrt{2} e^{-2\sqrt{q}} \left(1 - \frac{9}{16\sqrt{q}} - \frac{39}{256q} + \dots\right)$$

$$\frac{se_4'(0, q)}{se_4(\frac{1}{2}\pi, q)} \sim \frac{128}{3} q\sqrt{2} e^{-2\sqrt{q}} \left(1 - \frac{31}{16\sqrt{q}} - \frac{15}{128q} + \dots\right)$$

For higher orders, these ratios are increasingly more difficult to obtain. One method of estimating values at the origin is to evaluate both 20.9.11 and 20.9.15 for some  $x$  where both expansions are satisfactory, and so to use 20.9.11 as a means to solve for  $ce_r(0, q)$ ; similarly for  $se_r'(0, q)$ .

Other asymptotic expansions, valid over various regions of the complex  $z$ -plane, for real values of  $a, q$ , have been given by Langer [20.25]. It is not always easy, however, to determine the linear combinations of Langer's solutions which coincide with those defined here.

## 20.10. Comparative Notations

|  | This Volume   | [20.58]<br>NBS   | [20.59]<br>Stratton-Morse, etc.  | [20.36]<br>Meixner and Schäfer   | [20.30]<br>McLachlan   | [20.15]<br>Bateman Manuscript  | Comments                   |
|--|---|--|--|--|--|--|----------------------------|
| Parameters in 20.1.1.....  | $a$<br>$q$<br>$a_r$<br>$b_r$  | $b = a + 2q$<br>$s = 4q$   | $b$<br>$c = 2\sqrt{q}$   | $\lambda$<br>$h^2$   | $a$<br>$q$   | $h$<br>$\theta$  |                            |
| Periodic Solutions, of 20.1.1:   |   |  |  |  |  |  |                            |
| Even.....  | $ce_r(z, q)$  | $A^r Se_r(s, z)$ *   | $A^r Se_r^{(1)}(z, \cos x)$ *  | $ce_r(z, h^2)$ *   | $ce_r(z, q)$   | $ce_r(z, \theta)$  | See Note 1.                |
| Odd.....   | $se_r(z, q)$  | $B^r So_r(s, z)$ *   | $A^r So_r^{(1)}(z, \cos x)$ *  | $se_r(z, h^2)$ *   | $se_r(z, q)$   | $se_r(z, \theta)$  |                            |
| Coefficients in Periodic Solutions:  |   |  |  |  |  |  |                            |
| Even.....  | $A_m^r(q)$  | $A^r De_m^r(s)$ *  | $A^r D_m^r$ *  | $A_m^r$  | $A_m^r$  | $A_m^r$  |                            |
| Odd.....   | $B_m^r(q)$  | $B^r Do_m^r(s)$ *  | $B^r F_m^r$ *  | $B_m^r$  | $B_m^r$  | $B_m^r$  |                            |
| $\frac{1}{\pi} \int_0^{2\pi} y^2 dx$ , $y$ is the Standard Solution of 20.1.1. | 1   | $(A^r)^{-1}$ or $(B^r)^{-1}$   | $(A^r)^{-1}$ or $(B^r)^{-1}$   | 1  | 1  | 1  | See Note 1.                |
| Floquet's Solutions 20.3.3.....  | $F_r(z)$  |  |  | $me_r(z, h^2)$   | $\phi(z)$  |  |                            |
| Characteristic Exponent.....   | $\nu$   | $\mu = i\nu$   |  | $\nu$  | $\mu = i\nu$   | $\mu = i\nu$   |                            |
| Normalizations of Floquet's Solutions.   | Unspecified   |  |  | $\frac{1}{\pi} \int_0^{2\pi} (me_r(z, h^2) me_{-r}(z, h^2)) = 1$   |  |  |                            |
| Solutions of Modified Equation 20.1.2.   | $Ce_r(z, q)$<br>$Se_r(z, q)$<br>$Mc_r^{(1)}(z, q)$<br>$Ms_r^{(1)}(z, q)$<br>$Mc_r^{(2)}(z, q)$<br>$Ms_r^{(2)}(z, q)$  | $Ag_{s,r}(s) Je_r(s, q)$<br>$Bg_{s,r}(s) Jo_r(s, q)$<br>$\sqrt{\frac{2}{\pi}} Je_r(s, z)$<br>$\sqrt{\frac{2}{\pi}} Jo_r(s, z)$<br>$\sqrt{\frac{2}{\pi}} Ne_r(s, z)$<br>$\sqrt{\frac{2}{\pi}} No_r(s, z)$ | $Ag_{s,r}(s) Je_r(c, \cosh z)$<br>$Bg_{s,r}(s) Jo_r(c, \cosh z)$<br>$\sqrt{\frac{2}{\pi}} Je_r(c, \cosh z)$<br>$\sqrt{\frac{2}{\pi}} Jo_r(c, \cosh z)$<br>$\sqrt{\frac{2}{\pi}} Ne_r(c, \cosh z)$<br>$\sqrt{\frac{2}{\pi}} No_r(c, \cosh z)$ | $Ce_r(z, q)$<br>$Se_r(z, q)$<br>$Mc_r^{(1)}(z, h)$<br>$Ms_r^{(1)}(z, h)$<br>$Mc_r^{(2)}(z, h)$<br>$Ms_r^{(2)}(z, h)$                                       | $Ce_r(z, q)$<br>$Se_r(z, q)$<br>$\sqrt{\frac{2}{\pi}} Ce_r(z, q) / Ag_{s,r}(q)$<br>$\sqrt{\frac{2}{\pi}} Se_r(z, q) / Bg_{s,r}(q)$<br>$\sqrt{\frac{2}{\pi}} Fe_{y_r}(z, q) / Ag_{s,r}(q)$<br>$\sqrt{\frac{2}{\pi}} Ge_{y_r}(z, q) / Bg_{s,r}(q)$ | $Ce_r(z, \theta)$<br>$Se_r(z, \theta)$<br>$\sqrt{\frac{2}{\pi}} Ce_r(z, \theta) / Ag_{s,r}(q)$<br>$\sqrt{\frac{2}{\pi}} Se_r(z, \theta) / Bg_{s,r}(q)$<br>$\sqrt{\frac{2}{\pi}} Fe_{y_r}(z, \theta) / Ag_{s,r}(q)$<br>$\sqrt{\frac{2}{\pi}} Ge_{y_r}(z, \theta) / Bg_{s,r}(q)$ |                            |
| Joining Factors.....   | $\sqrt{2/\pi} / Mc_r^{(1)}(0, q)$<br>$\sqrt{2/\pi} \frac{d}{dz} [Ms_r^{(1)}(z, q)]_{z=0}$<br>$-Mc_r^{(2)}(0, q) / Mc_r^{(1)}(0, q)$<br>$\left[ \frac{d}{dz} Ms_r^{(2)}(z, q) \right]_{z=0}$<br>$\left[ \frac{d}{dz} Ms_r^{(1)}(z, q) \right]_{z=0}$ | $g_{s,r}(s)$<br>$g_{s,r}(s)$<br>$f_{s,r}(s)$<br>$f_{s,r}(s)$   | $\sqrt{2\pi} \lambda_r^{(6)}$<br>$\sqrt{2\pi} \lambda_r^{(0)}$<br>$-\frac{2}{\pi} \frac{K_1'}{K_1}$<br>$\frac{2}{\pi} \frac{K_1'}{K_1}$  | $\sqrt{2/\pi} / Mc_r^{(1)}(0, h)$<br>$\sqrt{2/\pi} \frac{d}{dz} [Ms_r^{(1)}(z, h)]_{z=0}$<br>$-Mc_r^{(2)}(0, h) / Mc_r^{(1)}(0, h)$<br>Same as this volume | $(-1)^r p_r \sqrt{\frac{2}{\pi}} / A$<br>$(-1)^r s_r \sqrt{\frac{2}{\pi}} / B$<br>$-\frac{Fe_{y_r}(0, q)}{Ce_r(0, q)}$<br>$\left[ \frac{d}{dz} Ge_{y_r}(z, q) \right]_{z=0}$<br>$\left[ \frac{d}{dz} Se_r(z, q) \right]_{z=0}$                   | Same as [20.30]<br>Same as [20.30]   | See Note 2.<br>See Note 3. |

- NOTE: 1. The conversion factors  $A^r$  and  $B^r$  are tabulated in [20.58] along with the coefficients.  
 2. The multipliers  $p_r$  and  $s_r$  are defined in [20.30], Appendix 1, section 3, equations 3, 4, 5, 6.  
 3. See [20.59], sections (5.3) and (5.5). In eq. (316) of (5.5), the first term should have a minus sign.

\* See page II.

## References

## Texts

- [20.1] W. G. Bickley, The tabulation of Mathieu functions, *Math. Tables Aids Comp.* **1**, 409-419 (1945).
- [20.2] W. G. Bickley and N. W. McLachlan, Mathieu functions of integral order and their tabulation, *Math. Tables Aids Comp.* **2**, 1-11 (1946).
- [20.3] G. Blanch, On the computation of Mathieu functions, *J. Math. Phys.* **25**, 1-20 (1946).
- [20.4] G. Blanch, The asymptotic expansions for the odd periodic Mathieu functions, *Trans. Amer. Math. Soc.* **97**, 2, 357-366 (1960).
- [20.5] C. J. Bouwkamp, A note on Mathieu functions, *Kon. Nederl. Akad. Wetensch. Proc.* **51**, 891-893 (1948).
- [20.6] C. J. Bouwkamp, On spheroidal wave functions of order zero. *J. Math. Phys.* **26**, 79-92 (1947).
- [20.7] M. R. Campbell, Sur les solutions de période  $2\pi$  de l'équation de Mathieu associée, *C.R. Acad. Sci., Paris*, **223**, 123-125 (1946).
- [20.8] M. R. Campbell, Sur une catégorie remarquable de solutions de l'équation de Mathieu associée, *C.R. Acad. Sci., Paris*, **226**, 2114-2116 (1948).
- [20.9] T. M. Cherry, Uniform asymptotic formulae for functions with transition points, *Trans. Amer. Math. Soc.* **68**, 224-257 (1950).
- [20.10] S. C. Dhar, *Mathieu functions* (Calcutta Univ. Press, Calcutta, India, 1928).
- [20.11] J. Dougall, The solution of Mathieu's differential equation, *Proc. Edinburgh Math. Soc.* **34**, 176-196 (1916).
- [20.12] J. Dougall, On the solutions of Mathieu's differential equation, and their asymptotic expansions, *Proc. Edinburgh Math. Soc.* **41**, 26-48 (1923).
- [20.13] A. Erdélyi, Über die Integration der Mathieschen Differentialgleichung durch Laplacesche Integrale, *Math. Z.* **41**, 653-664 (1936).
- [20.14] A. Erdélyi, On certain expansions of the solutions of Mathieu's differential equation, *Proc. Cambridge Philos. Soc.* **38**, 28-33 (1942).
- [20.15] A. Erdélyi et al., *Higher transcendental functions*, vol. 3 (McGraw-Hill Book Co., Inc., New York, N.Y., 1955).
- [20.16] G. Floquet, Sur les équations différentielles linéaires à coefficients périodiques, *Ann. École Norm. Sup.* **12**, 47 (1883).
- [20.17] S. Goldstein, The second solution of Mathieu's differential equation, *Proc. Cambridge Philos. Soc.* **24**, 223-230 (1928).
- [20.18] S. Goldstein, Mathieu functions, *Trans. Cambridge Philos. Soc.* **23**, 303-336 (1927).
- [20.19] G. W. Hill, On the path of motion of the lunar perigee, *Acta Math.* **8**, 1 (1886).
- [20.20] E. Hille, On the zeros of the Mathieu functions, *Proc. London Math. Soc.* **23**, 185-237 (1924).
- [20.21] E. L. Ince, A proof of the impossibility of the co-existence of two Mathieu functions, *Proc. Cambridge Philos. Soc.* **21**, 117-120 (1922).
- [20.22] E. L. Ince, *Ordinary differential equations* (Longmans, Green & Co., 1927, reprinted by Dover Publications, Inc., New York, N.Y., 1944).
- [20.23] H. Jeffreys, On the modified Mathieu's equation, *Proc. London Math. Soc.* **23**, 449-454 (1924).
- [20.24] V. D. Kupradze, *Fundamental problems in the mathematical theory of diffraction* (1935). Translated from the Russian by Curtis D. Benster, NBS Report 200 (Oct. 1952).
- [20.25] R. E. Langer, The solutions of the Mathieu equation with a complex variable and at least one parameter large, *Trans. Amer. Math. Soc.* **36**, 637-695 (1934).
- [20.26] S. Lubkin and J. J. Stoker, Stability of columns and strings under periodically varying forces, *Quart. Appl. Math.* **1**, 215-236 (1943).
- [20.27] É. Mathieu, Mémoire sur le mouvement vibratoire d'une membrane de forme elliptique, *J. Math. Pures Appl.* **13**, 137-203 (1868).
- [20.28] N. W. McLachlan, Mathieu functions and their classification, *J. Math. Phys.* **25**, 209-240 (1946).
- [20.29] N. W. McLachlan, *Mathieu functions of fractional order*, *J. Math. Phys.* **26**, 29-41 (1947).
- [20.30] N. W. McLachlan, *Theory and application of Mathieu functions* (Clarendon Press, Oxford, England, 1947).
- [20.31] N. W. McLachlan, Application of Mathieu's equation to stability of non-linear oscillator, *Math. Gaz.* **35**, 105-107 (1951).
- [20.32] J. Meixner, Über das asymptotische Verhalten von Funktionen, die durch Reihen nach Zylinderfunktionen dargestellt werden können, *Math. Nachr.* **3**, 9-13, Reihenentwicklungen von Produkten zweier Mathieschen Funktionen nach Produkten von Zylinder und Exponentialfunktionen, 14-19 (1949).
- [20.33] J. Meixner, Integralbeziehungen zwischen Mathieschen Funktionen, *Math. Nachr.* **5**, 371-378 (1951).
- [20.34] J. Meixner, Reihenentwicklungen vom Siegerschen Typus für die Sphäroid Funktionen, *Arch. Math. Oberwolfach* **1**, 432-440 (1949).
- [20.35] J. Meixner, Asymptotische Entwicklung der Eigenwerte und Eigenfunktionen der Differentialgleichungen der Sphäroidfunktionen und der Mathieschen Funktionen, *Z. Angew. Math. Mech.* **28**, 304-310 (1948).
- [20.36] J. Meixner and F. W. Schäfke, *Mathiesche Funktionen und Sphäroidfunktionen* (Springer-Verlag, Berlin, Germany, 1954).
- [20.37] P. M. Morse and P. J. Rubinstein, The diffraction of waves by ribbons and by slits, *Phys. Rev.* **54**, 895-898 (1938).
- [20.38] H. P. Mulholland and S. Goldstein, The characteristic numbers of the Mathieu equation with purely imaginary parameters, *Phil. Mag.* **8**, 834-840 (1929).
- [20.39] L. Onsager, *Solutions of the Mathieu equation of period  $4\pi$  and certain related functions* (Yale Univ. Dissertation, New Haven, Conn., 1935).

- [20.40] F. W. Schäfke, Über die Stabilitätskarte der Mathieschen Differentialgleichung, *Math. Nachr.* **4**, 175–183 (1950).
- [20.41] F. W. Schäfke, Das Additions theorem der Mathieschen Funktionen, *Math. Z.* **58**, 436–447 (1953).
- [20.42] F. W. Schäfke, Eine Methode zur Berechnung des charakteristischen Exponenten einer Hillschen Differentialgleichung, *Z. Angew. Math. Mech.* **33**, 279–280 (1953).
- [20.43] B. Sieger, Die Beugung einer ebenen elektrischen Welle an einem Schirm von elliptischem Querschnitt, *Ann. Physik.* **4**, **27**, 626–664 (1908).
- [20.44] R. Sips, Représentation asymptotique des fonctions de Mathieu et des fonctions d'onde sphéroïdales, *Trans. Amer. Math. Soc.* **66**, 93–134 (1949).
- [20.45] R. Sips, Représentation asymptotique des fonctions de Mathieu et des fonctions sphéroïdales II, *Trans. Amer. Math. Soc.* **90**, **2**, 340–368 (1959).
- [20.46] R. Sips, Recherches sur les fonctions de Mathieu, *Bull. Soc. Roy. Sci. Liège* **22**, 341–355, 374–387, 444–455, 530–540 (1953); **23**, 37–47, 90–103 (1954).
- [20.47] M. J. O. Strutt, Die Hillsche Differentialgleichung im komplexen Gebiet, *Nieuw. Arch. Wisk.* **18** 31–55 (1935).
- [20.48] M. J. O. Strutt, Lamésche, Mathiesche und verwandte Funktionen in Physik und Technik, *Ergeb. Math. Grenzgeb.* **1**, 199–323 (1932).
- [20.49] M. J. O. Strutt, On Hill's problems with complex parameters and a real periodic function, *Proc. Roy. Soc. Edinburgh Sect. A* **62**, 278–296 (1948).
- [20.50] E. T. Whittaker, On functions associated with elliptic cylinders in harmonic analysis, *Proc. Intl. Congr. Math. Cambr.* **1**, 366 (1912).
- [20.51] E. T. Whittaker, On the general solution of Mathieu's equation, *Proc. Edinburgh Math. Soc.* **32**, 75–80 (1914).
- [20.52] E. T. Whittaker and G. N. Watson, *A course of modern analysis*, 4th ed. (Cambridge Univ. Press, Cambridge, England, 1952).
- Tables**
- [20.53] G. Blanch and I. Rhodes, Table of characteristic values of Mathieu's equation for large values of the parameter, *J. Washington Acad. Sci.* **45**, **6**, 166–196 (1955).  $Be_r(t) = a_r(q) + 2q - 2(2r+1)\sqrt{q}$ ,  $Bo_r(t) = b_r(q) + 2q - 2(2r-1)\sqrt{q}$ ,  $t = 1/2\sqrt{q}$ ,  $r = 0(1)15$ ,  $0 \leq t \leq .1$ , with  $\delta^2$ ,  $\delta^{4*}$ ; 8D (about); interpolable.
- [20.54] J. G. Brainerd, H. J. Gray, and R. Merwin, Solution of the Mathieu equation, *Am. Inst. Elec. Engrs.* **67** (1948). Characteristic exponent over a wide range.  $\mu$ ,  $M$  for  $\epsilon = 1(1)10$ ;  $k = .1(1)1$ , 5D;  $g(t)$ ,  $h(t)$  for  $t = 0(1)3.1$ ,  $\pi$ , 5D;  $\epsilon = 1(1)10$ ,  $k = .1(1)1$ , where  $g(t)$ ,  $h(t)$  are solutions of  $y'' + \epsilon(1+k \cos t)y = 0$ , with  $g(0) = h'(0) = 1$ ,  $g'(0) = h(0) = 0$ ,  $\cos 2\pi\mu = 2g(\pi)h'(\pi) - 1$ ,  $M = [-g(\pi)g'(\pi)/h(\pi)h'(\pi)]^{1/2}$ .
- [20.55] J. G. Brainerd and C. N. Weygandt, Solutions of Mathieu's equation, *Phil. Mag.* **30**, 458–477 (1940).
- [20.56] E. L. Ince, Tables of the elliptic cylinder functions, *Proc. Roy. Soc. Edinburgh* **52**, 355–423; Zeros and turning points, **52**, 424–433 (1932). Characteristic values  $a_0, a_1, \dots, a_s, b_1, b_2, \dots, b_s$ , and coefficients for  $\theta = 0(1)10(2)20(4)40$ ; 7D. Also  $ce_r(x, \theta)$ ,  $se_r(x, \theta)$ ,  $\theta = 0(1)10$ ,  $x = 0^\circ(1^\circ)90^\circ$ ; 5D, corresponding to characteristic values in the tables.  $a_r = be_r - 2q$ ;  $b_r = bo_r - 2q$ ;  $\theta = q$ .
- [20.57] E. T. Kirkpatrick, Tables of values of the modified Mathieu function, *Math. Comp.* **14**, 70 (1960).  $Ce_r(u, q)$ ,  $r = 0(1)5$ ,  $Se_r(u, q)$ ,  $r = 1(1)6$ ;  $u = .1(1)1$ ;  $q = 1(1)20$ .
- [20.58] National Bureau of Standards, Tables relating to Mathieu functions (Columbia Univ. Press, New York, N.Y., 1951). Characteristic values  $be_r(s)$ ,  $bo_r(s)$  for  $0 \leq s \leq 100$ , along with  $\delta^{2*}$ , interpolable to 8D; coefficients  $De_k(s)$ ,  $Do_k(s)$  and conversion factors for  $ce_r(q)$ ,  $se_r(q)$ , same range, without differences but interpolable to 9D with Lagrangian formulas of order 7. "Joining factors"  $st'g_{a,r}$ ,  $st'g_{b,r}$ ,  $st'f_{a,r}$ ,  $st'f_{b,r}$  along with  $\delta^{2*}$ ; interpolable to 8S.
- [20.59] J. A. Stratton, P. M. Morse, L. J. Chu and R. A. Hutner, *Elliptic cylinder and spheroidal wave functions* (John Wiley & Sons, Inc., New York, N.Y., 1941). Theory and tables for  $b_0, b_1, b_2, b_3, b_4, b'_1, b'_2, b'_3, b'_4$ , and coefficients for  $Se_r(s, x)$  and  $So_r(s, x)$  for  $c = 0(.2)4.4$  and  $.5(1)4.5$ ; mostly 5S;  $c = 2q^{\frac{1}{2}}$ ,  $b_r = a_r + 2q$ ,  $b'_r = b_r + 2q$ .
- [20.60] T. Tamir, Characteristic exponents of Mathieu\* equations, *Math. Comp.* **16**, 77 (1962). The Floquet exponent  $\nu_r$  of the first three stable regions; namely  $r = 0, 1, 2$ ;  $q = .1(1)2.5$ ;  $a = r(.1)r + 1$ , 5D.
- [20.61] J. C. Wiltse and M. J. King, Values of the Mathieu functions, The Johns Hopkins Univ. Radiation Laboratory Technical Report AF-53, Baltimore, Md. (1958). (Notation of [20.58] used:  $ce_n(v, q)/A$ ,  $se_n(v, q)/B$  for 12 values of  $q$  between .25 and 10 and from 8 to 14 values of  $v$ ;  $\sqrt{\pi}/2 Mc_j^{(u, q)}$ ,  $\sqrt{\pi}/2 Ms_j^{(u, q)}$ ,  $j = 1, 2$  for 6 to 8 values of  $q$  between .25 and 10 and about 20 values of  $u$ ,  $r = 0, 1, 2$ ;  $\sqrt{\pi}/2 Mc_j^{(s)}(-|u|, q)$ ,  $\sqrt{\pi}/2 Ms_j^{(s)}(-|u|, q)$ ,  $r = 0, 1, 2$  for about 9 values of  $u$  and  $q$ , 2 to 4 D in all.
- [20.62] J. C. Wiltse and M. J. King, Derivatives, zeros, and other data pertaining to Mathieu functions, The Johns Hopkins Univ. Radiation Laboratory Technical Report AF-57, Baltimore, Md. (1958).
- [20.63] S. J. Zaroodny, An elementary review of the Mathieu-Hill equation of real variable based on numerical solutions, Ballistic Research Laboratory Memorandum Report 878, Aberdeen Proving Ground, Md. (1955). Chart of the characteristic exponent.  
See also [20.18]. It contains, among other tabulations, values of  $a_r$ ,  $b_r$  and coefficients for  $ce_r(x, q)$ ,  $se_r(x, q)$ ,  $q = 40(20)100(50)200$ ; 5D,  $r \leq 2$ .

\*See page II.

# 21. Spheroidal Wave Functions

ARNOLD N. LOWAN<sup>1</sup>

## Contents

|  | Page |
|--|------|
| <b>Mathematical Properties</b> . . . . .   | 752  |
| 21.1. Definition of Elliptical Coordinates . . . . .                                       | 752  |
| 21.2. Definition of Prolate Spheroidal Coordinates . . . . .                               | 752  |
| 21.3. Definition of Oblate Spheroidal Coordinates . . . . .                                | 752  |
| 21.4. Laplacian in Spheroidal Coordinates . . . . .  | 752  |
| 21.5. Wave Equation in Prolate and Oblate Spheroidal Coordinates . . . . .                 | 752  |
| 21.6. Differential Equations for Radial and Angular Spheroidal<br>Wave Functions . . . . . | 753  |
| 21.7. Prolate Angular Functions . . . . .  | 753  |
| 21.8. Oblate Angular Functions . . . . .   | 756  |
| 21.9. Radial Spheroidal Wave Functions . . . . .   | 756  |
| 21.10. Joining Factors for Prolate Spheroidal Wave Functions . . . . .                     | 757  |
| 21.11. Notation . . . . .  | 758  |
| <b>References</b> . . . . .  | 759  |
| <b>Table 21.1. Eigenvalues—Prolate and Oblate</b> . . . . .                                | 760  |
| $m=0(1)2, n=m(1)m+4$<br>$c^2=0(1)16, c^{-1}=.25(-.01)0, 4-6D$                              |      |
| <b>Table 21.2. Angular Functions—Prolate and Oblate</b> . . . . .                          | 766  |
| $m=0(1)2, n=m(1)3, \eta=0(.1)1$<br>$\theta=0^\circ(10^\circ)90^\circ, c=1(1)5, 2-4D$       |      |
| <b>Table 21.3. Prolate Radial Functions—First and Second Kinds</b> . . . . .               | 768  |
| $m=0(1)2, n=m(1)3$<br>$\xi=1.005, 1.02, 1.044, 1.077, c=1(1)5, 4S$                         |      |
| <b>Table 21.4. Oblate Radial Functions—First and Second Kinds</b> . . . . .                | 769  |
| $m=0, 1, n=m(1)m+2; m, n=2$<br>$\xi=0, .75, c=.2, .5, .8, 1(.5)2.5, 5S$                    |      |
| <b>Table 21.5. Prolate Joining Factors—First Kind</b> . . . . .                            | 769  |
| $m=0, 1, n=m(1)m+2; m, n=2$<br>$c=1(1)5, 4S$   |      |

<sup>1</sup>Yeshiva University. (Prepared under contract with the National Bureau of Standards.) (Deceased.)

# 21. Spheroidal Wave Functions

## Mathematical Properties

### 21.1. Definition of Elliptical Coordinates

$$21.1.1 \quad \xi = \frac{r_1 + r_2}{2f}; \quad \eta = \frac{r_1 - r_2}{2f}$$

$r_1$  and  $r_2$  are the distances to the foci of a family of confocal ellipses and hyperbolas;  $2f$  is the distance between foci.

$$21.1.2 \quad a = f\xi, \quad b = f\sqrt{\xi^2 - 1}, \quad e = \frac{f}{a}$$

$a$  = semi-major axis;  $b$  = semi-minor axis;  $e$  = eccentricity.

#### Equation of Family of Confocal Ellipses

$$21.1.3 \quad \frac{x^2}{\xi^2} + \frac{y^2}{\xi^2 - 1} = f^2 \quad (1 < \xi < \infty)$$

#### Equation of Family of Confocal Hyperbolas

$$21.1.4 \quad \frac{x^2}{\eta^2} - \frac{y^2}{1 - \eta^2} = f^2 \quad (-1 < \eta < 1)$$

#### Relations Between Cartesian and Elliptical Coordinates

$$21.1.5 \quad x = f\xi\eta; \quad y = f\sqrt{(\xi^2 - 1)(1 - \eta^2)}$$

### 21.2. Definition of Prolate Spheroidal Coordinates

If the system of confocal ellipses and hyperbolas referred to in 21.1.3 and 21.1.4 revolves around the major axis, then

$$21.2.1 \quad \frac{x^2}{\xi^2} + \frac{r^2}{\xi^2 - 1} = f^2; \quad \frac{x^2}{\eta^2} - \frac{r^2}{1 - \eta^2} = f^2$$

$$y = r \cos \phi; \quad z = r \sin \phi; \quad 0 \leq \phi \leq 2\pi$$

where  $\xi$ ,  $\eta$  and  $\phi$  are prolate spheroidal coordinates.

#### Relations Between Cartesian and Prolate Spheroidal Coordinates

##### 21.2.2

$$x = f\xi\eta; \quad y = f\sqrt{(\xi^2 - 1)(1 - \eta^2)} \cos \phi; \\ z = f\sqrt{(\xi^2 - 1)(1 - \eta^2)} \sin \phi$$

### 21.3. Definition of Oblate Spheroidal Coordinates

If the system of confocal ellipses and hyperbolas referred to in 21.1.3 and 21.1.4 revolves around the minor axis, then

$$21.3.1 \quad \frac{r^2}{\xi^2} + \frac{y^2}{\xi^2 - 1} = f^2; \quad \frac{r^2}{\eta^2} - \frac{y^2}{1 - \eta^2} = f^2$$

$$z = r \cos \phi; \quad x = r \sin \phi; \quad 0 \leq \phi \leq 2\pi$$

where  $\xi$ ,  $\eta$  and  $\phi$  are oblate spheroidal coordinates.

#### Relations Between Cartesian and Oblate Spheroidal Coordinates

##### 21.3.2

$$x = f\xi\eta \sin \phi; \quad y = f\sqrt{(\xi^2 - 1)(1 - \eta^2)}; \quad z = f\xi\eta \cos \phi$$

### 21.4. Laplacian in Spheroidal Coordinates

#### 21.4.1

$$\nabla^2 = \frac{1}{h_\xi h_\eta h_\phi} \left[ \frac{\partial}{\partial \xi} \left( \frac{h_\eta h_\phi}{h_\xi} \frac{\partial}{\partial \xi} \right) + \frac{\partial}{\partial \eta} \left( \frac{h_\xi h_\phi}{h_\eta} \frac{\partial}{\partial \eta} \right) + \frac{\partial}{\partial \phi} \left( \frac{h_\xi h_\eta}{h_\phi} \frac{\partial}{\partial \phi} \right) \right]^*$$

$$h_\xi^2 = \left( \frac{\partial x}{\partial \xi} \right)^2 + \left( \frac{\partial y}{\partial \xi} \right)^2 + \left( \frac{\partial z}{\partial \xi} \right)^2$$

$$h_\eta^2 = \left( \frac{\partial x}{\partial \eta} \right)^2 + \left( \frac{\partial y}{\partial \eta} \right)^2 + \left( \frac{\partial z}{\partial \eta} \right)^2$$

$$h_\phi^2 = \left( \frac{\partial x}{\partial \phi} \right)^2 + \left( \frac{\partial y}{\partial \phi} \right)^2 + \left( \frac{\partial z}{\partial \phi} \right)^2$$

#### Metric Coefficients for Prolate Spheroidal Coordinates

##### 21.4.2

$$h_\xi = f\sqrt{\frac{\xi^2 - \eta^2}{\xi^2 - 1}}; \quad h_\eta = f\sqrt{\frac{\xi^2 - \eta^2}{1 - \eta^2}}; \quad h_\phi = f\sqrt{(\xi^2 - 1)(1 - \eta^2)}^*$$

#### Metric Coefficients for Oblate Spheroidal Coordinates

##### 21.4.3

$$h_\xi = f\sqrt{\frac{\xi^2 - \eta^2}{\xi^2 - 1}}; \quad h_\eta = f\sqrt{\frac{\xi^2 - \eta^2}{1 - \eta^2}}; \quad h_\phi = f\xi\eta^*$$

### 21.5. Wave Equation in Prolate and Oblate Spheroidal Coordinates

#### Wave Equation in Prolate Spheroidal Coordinates

##### 21.5.1

$$\nabla^2 \Phi + k^2 \Phi = \frac{\partial}{\partial \xi} \left[ (\xi^2 - 1) \frac{\partial \Phi}{\partial \xi} \right] + \frac{\partial}{\partial \eta} \left[ (1 - \eta^2) \frac{\partial \Phi}{\partial \eta} \right] \\ + \frac{\xi^2 - \eta^2}{(\xi^2 - 1)(1 - \eta^2)} \frac{\partial^2 \Phi}{\partial \phi^2} + c^2 (\xi^2 - \eta^2) \Phi = 0$$

$$\left( c = \frac{1}{2}fk \right)$$

\*See page II.



Wave Equation in Oblate Spheroidal Coordinates

21.5.2

$$\nabla^2\Phi + k^2\Phi = \frac{\partial}{\partial\xi} \left[ (\xi^2 + 1) \frac{\partial\Phi}{\partial\xi} \right] + \frac{\partial}{\partial\eta} \left[ (1 - \eta^2) \frac{\partial\Phi}{\partial\eta} \right] + \frac{\xi^2 + \eta^2}{(\xi^2 + 1)(1 - \eta^2)} \frac{\partial^2\Phi}{\partial\phi^2} + c^2(\xi^2 + \eta^2)\Phi = 0$$

$$\left( c = \frac{1}{2}fk \right)$$

21.5.2 may be obtained from 21.5.1 by the transformations

$$\xi \rightarrow \pm i\xi, c \rightarrow \mp ic.$$

21.6. Differential Equations for Radial and Angular Prolate Spheroidal Wave Functions

If in 21.5.1 we put

$$\Phi = R_{mn}(c, \xi) S_{mn}(c, \eta) \frac{\cos}{\sin} m\phi$$

then the "radial solution"  $R_{mn}(c, \xi)$  and the "angular solution"  $S_{mn}(c, \eta)$  satisfy the differential equations

21.6.1

$$\frac{d}{d\xi} \left[ (\xi^2 - 1) \frac{d}{d\xi} R_{mn}(c, \xi) \right] - \left( \lambda_{mn} - c^2\xi^2 + \frac{m^2}{\xi^2 - 1} \right) R_{mn}(c, \xi) = 0$$

21.6.2

$$\frac{d}{d\eta} \left[ (1 - \eta^2) \frac{d}{d\eta} S_{mn}(c, \eta) \right] + \left( \lambda_{mn} - c^2\eta^2 - \frac{m^2}{1 - \eta^2} \right) S_{mn}(c, \eta) = 0$$

where the separation constants (or eigenvalues)  $\lambda_{mn}$  are to be determined so that  $R_{mn}(c, \xi)$  and  $S_{mn}(c, \eta)$  are finite at  $\xi = \pm 1$  and  $\eta = \pm 1$  respectively.

(21.6.1 and 21.6.2 are identical. Radial and angular prolate spheroidal functions satisfy the same differential equation over different ranges of the variable.)

Differential Equations for Radial and Angular Oblate Spheroidal Functions

21.6.3

$$\frac{d}{d\xi} \left[ (\xi^2 + 1) \frac{d}{d\xi} R_{mn}(c, \xi) \right] - \left( \lambda_{mn} - c^2\xi^2 - \frac{m^2}{\xi^2 + 1} \right) R_{mn}(c, \xi) = 0$$

21.6.4

$$\frac{d}{d\eta} \left[ (1 - \eta^2) \frac{d}{d\eta} S_{mn}(c, \eta) \right] + \left( \lambda_{mn} + c^2\eta^2 - \frac{m^2}{1 - \eta^2} \right) S_{mn}(c, \eta) = 0$$

(21.6.3 may be obtained from 21.6.1 by the transformations  $\xi \rightarrow \pm i\xi, c \rightarrow \mp ic$ ; 21.6.4 may be obtained from 21.6.2 by the transformation  $c \rightarrow \mp ic$ .)

21.7. Prolate Angular Functions

21.7.1

$$S_{mn}^{(1)}(c, \eta) = \sum_{r=0,1}^{\infty} d_r^{mn}(c) P_{m+r}^m(\eta)$$

=Prolate angular function of the first kind

21.7.2

$$S_{mn}^{(2)}(c, \eta) = \sum_{r=-\infty}^{\infty} d_r^{mn}(c) Q_{m+r}^m(\eta)$$

=Prolate angular function of the second kind

( $P_n^m(\eta)$  and  $Q_n^m(\eta)$  are associated Legendre functions of the first and second kinds respectively. However, for  $-1 \leq z \leq 1, P_n^m(z) = (1 - z^2)^{m/2} d^m P_n(z) / dz^m$  (see 8.6.6). The summation is extended over even values or odd values of  $r$ .)

Recurrence Relations Between the Coefficients

21.7.3

$$\alpha_k d_{k+2} + (\beta_k - \lambda_{mn}) d_k + \gamma_k d_{k-2} = 0$$

$$\alpha_k = \frac{(2m+k+2)(2m+k+1)c^2}{(2m+2k+3)(2m+2k+5)}$$

$$\beta_k = (m+k)(m+k+1) + \frac{2(m+k)(m+k+1) - 2m^2 - 1}{(2m+2k-1)(2m+2k+3)} c^2$$

$$\gamma_k = \frac{k(k-1)c^2}{(2m+2k-3)(2m+2k-1)}$$

Transcendental Equation for  $\lambda_{mn}$

21.7.4

$$U(\lambda_{mn}) = U_1(\lambda_{mn}) + U_2(\lambda_{mn}) = 0$$

$$U_1(\lambda_{mn}) = \gamma_r^m - \lambda_{mn} - \frac{\beta_r^m}{\gamma_{r-2}^m - \lambda_{mn}} - \frac{\beta_{r-2}^m}{\gamma_{r-4}^m - \lambda_{mn}} - \dots$$

$$U_2(\lambda_{mn}) = -\frac{\beta_{r+2}^m}{\gamma_{r+2}^m - \lambda_{mn}} - \frac{\beta_{r+4}^m}{\gamma_{r+4}^m - \lambda_{mn}} - \dots$$

$$\beta_k^m = \frac{k(k-1)(2m+k)(2m+k-1)c^4}{(2m+2k-1)^2(2m+2k+1)(2m+2k-3)} \quad (k \geq 2)$$

$$\gamma_k^m = (m+k)(m+k+1) + \frac{1}{2}c^2 \left[ 1 - \frac{4m^2 - 1}{(2m+2k-1)(2m+2k+3)} \right] \quad (k \geq 0)$$

(The choice of  $r$  in 21.7.4 is arbitrary.)



Power Series Expansion for  $\lambda_{mn}$ 

## 21.7.5

$$\lambda_{mn} = \sum_{k=0}^{\infty} l_{2k} c^{2k}$$

$$l_0 = n(n+1)$$

$$l_2 = \frac{1}{2} \left[ 1 - \frac{(2m-1)(2m+1)}{(2n-1)(2n+3)} \right]$$

$$l_4 = \frac{-(n-m+1)(n-m+2)(n+m+1)(n+m+2)}{2(2n+1)(2n+3)^3(2n+5)} + \frac{(n-m-1)(n-m)(n+m-1)(n+m)}{2(2n-3)(2n-1)^3(2n+1)}$$

$$l_6 = (4m^2-1) \left[ \frac{(n-m+1)(n-m+2)(n+m+1)(n+m+2)}{(2n-1)(2n+1)(2n+3)^5(2n+5)(2n+7)} - \frac{(n-m-1)(n-m)(n+m-1)(n+m)}{(2n-5)(2n-3)(2n-1)^5(2n+1)(2n+3)} \right]$$

$$l_8 = 2(4m^2-1)^2 A + \frac{1}{16} B + \frac{1}{8} C + \frac{1}{2} D$$

$$A = \frac{(n-m-1)(n-m)(n+m-1)(n+m)}{(2n-5)^2(2n-3)(2n-1)^7(2n+1)(2n+3)^2} - \frac{(n-m+1)(n-m+2)(n+m+1)(n+m+2)}{(2n-1)^2(2n+1)(2n+3)^7(2n+5)(2n+7)^2}$$

$$B = \frac{(n-m-3)(n-m-2)(n-m-1)(n-m)(n+m-3)(n+m-2)(n+m-1)(n+m)}{(2n-7)(2n-5)^2(2n-3)^3(2n-1)^4(2n+1)} \\ - \frac{(n-m+1)(n-m+2)(n-m+3)(n-m+4)(n+m+1)(n+m+2)(n+m+3)(n+m+4)}{(2n+1)(2n+3)^4(2n+5)^3(2n+7)^2(2n+9)}$$

$$C = \frac{(n-m+1)^2(n-m+2)^2(n+m+1)^2(n+m+2)^2}{(2n+1)^2(2n+3)^7(2n+5)^2} - \frac{(n-m-1)^2(n-m)^2(n+m-1)^2(n+m)^2}{(2n-3)^2(2n-1)^7(2n+1)^2}$$

$$D = \frac{(n-m-1)(n-m)(n-m+1)(n-m+2)(n+m-1)(n+m)(n+m+1)(n+m+2)}{(2n-3)(2n-1)^4(2n+1)^2(2n+3)^4(2n+5)}$$

Asymptotic Expansion for  $\lambda_{mn}$ 

## 21.7.6

$$\lambda_{mn}(c) = cq + m^2 - \frac{1}{8}(q^2+5) - \frac{q}{64c}(q^2+11-32m^2) \\ - \frac{1}{1024c^2}[5(q^4+26q^2+21)-384m^2(q^2+1)] \\ - \frac{1}{c^3} \left[ \frac{1}{128^2}(33q^5+1594q^3+5621q) \right. \\ \left. - \frac{m^2}{128}(37q^3+167q) + \frac{m^4}{8}q \right] \\ - \frac{1}{c^4} \left[ \frac{1}{256^2}(63q^6+4940q^4+43327q^2+22470) \right. \\ \left. - \frac{m^2}{512}(115q^4+1310q^2+735) + \frac{3m^4}{8}(q^2+1) \right] \\ - \frac{1}{c^5} \left[ \frac{1}{1024^2}(527q^7+61529q^5+1043961q^3) \right. \\ \left. + 2241599q - \frac{m^2}{32 \cdot 1024}(5739q^5+127550q^3) \right. \\ \left. + 298951q + \frac{m^4}{512}(355q^3+1505q) - \frac{m^6q}{16} \right] + O(c^{-6}) \\ q = 2(n-m) + 1$$

Refinement of Approximate Values of  $\lambda_{mn}$ 

If  $\lambda_{mn}^{(1)}$  is an approximation to  $\lambda_{mn}$  obtained either from 21.7.5 or 21.7.6 then

## 21.7.7

$$\lambda_{mn} = \lambda_{mn}^{(1)} + \delta\lambda_{mn}$$

$$\delta\lambda_{mn} = \frac{U_1(\lambda_{mn}^{(1)}) + U_2(\lambda_{mn}^{(1)})}{\Delta_1 + \Delta_2}$$

$$\Delta_1 = 1 + \frac{\beta_r^m}{(N_r^m)^2} + \frac{\beta_r^m \beta_{r-2}^m}{(N_r^m N_{r-2}^m)^2} + \frac{\beta_r^m \beta_{r-2}^m \beta_{r-4}^m}{(N_r^m N_{r-2}^m N_{r-4}^m)^2} + \dots$$

$$\Delta_2 = \frac{(N_{r+2}^m)^2}{\beta_{r+2}^m} + \frac{(N_{r+2}^m N_{r+4}^m)^2}{\beta_{r+2}^m \beta_{r+4}^m} + \frac{(N_{r+2}^m N_{r+4}^m N_{r+6}^m)^2}{\beta_{r+2}^m \beta_{r+4}^m \beta_{r+6}^m} + \dots$$

$$N_r^m = \frac{(2m+r)(2m+r-1)c^2}{(2m+2r-1)(2m+2r+1)} \frac{d_r}{d_{r-2}} \quad (r \geq 2)$$

$$\beta_r^m = \frac{r(r-1)(2m+r)(2m+r-1)c^4}{(2m+2r-1)^2(2m+2r+1)(2m+2r-3)} \quad (r \geq 2)$$

Evaluation of Coefficients

Step 1. Calculate  $N_r^m$ 's from

21.7.8

$$N_{r+2}^m = \gamma_r^m - \lambda_{mn} - \frac{\beta_r^m}{N_r^m} \quad (r \geq 2)$$

$$N_2^m = \gamma_0^m - \lambda_{mn}; N_3^m = \gamma_1^m - \lambda_{mn}$$

$$\gamma_r^m = (m+r)(m+r+1)$$

$$+ \frac{1}{2} c^2 \left[ 1 - \frac{4m^2 - 1}{(2m+2r-1)(2m+2r+3)} \right] \quad (r \geq 0)$$

Step 2. Calculate ratios  $\frac{d_0}{d_{2r}}$  and  $\frac{d_1}{d_{2p+1}}$  from

21.7.9 
$$\frac{d_0}{d_{2r}} = \left(\frac{d_0}{d_2}\right) \left(\frac{d_2}{d_4}\right) \dots \left(\frac{d_{2r-2}}{d_{2r}}\right)$$

21.7.10 
$$\frac{d_1}{d_{2p+1}} = \left(\frac{d_1}{d_3}\right) \left(\frac{d_3}{d_5}\right) \dots \left(\frac{d_{2p-1}}{d_{2p+1}}\right)$$

and the formula for  $N_r^m$  in 21.7.7.

The coefficients  $d_r^m$  are determined to within the arbitrary factor  $d_0$  for  $r$  even and  $d_1$  for  $r$  odd. The choice of these factors depends on the normalization scheme adopted.

Normalization of Angular Functions

Meixner-Schäpfke Scheme

21.7.11 
$$\int_{-1}^1 [S_{mn}(c, \eta)]^2 d\eta = \frac{2}{2n+1} \frac{(n+m)!}{(n-m)!}$$

Stratton-Morse-Chu-Little-Corbató Scheme

21.7.12 
$$\sum_{r=0,1} \frac{(r+2m)!}{r!} d_r = \frac{(n+m)!}{(n-m)!}$$

(This normalization has the effect that  $S_{mn}(c, \eta) \rightarrow P_n^m(\eta)$  as  $\eta \rightarrow 1$ .)

Flammer Scheme [21.4]

21.7.13

$$S_{mn}(c, 0) = P_n^m(0) = \frac{(-1)^{\frac{n-m}{2}} (n+m)!}{2^n \left(\frac{n-m}{2}\right)! \left(\frac{n+m}{2}\right)!}$$

$(n-m)$  even

21.7.14

$$S'_{mn}(c, 0) = P_n^{m'}(0) = \frac{(-1)^{\frac{n-m-1}{2}} (n+m+1)!}{2^n \left(\frac{n-m-1}{2}\right)! \left(\frac{n+m+1}{2}\right)!}$$

$(n-m)$  odd

The above lead to the following conditions for  $d_r^m$

21.7.15

$$\sum_{r=0}^{\infty} \frac{(-1)^{r/2} (r+2m)!}{2^r \left(\frac{r}{2}\right)! \left(\frac{r+2m}{2}\right)!} d_r^m = \frac{(-1)^{\frac{n-m}{2}} (n+m)!}{2^{n-m} \left(\frac{n-m}{2}\right)! \left(\frac{n+m}{2}\right)!}$$

$(n-m)$  even

21.7.16

$$\sum_{r=1}^{\infty} \frac{(-1)^{\frac{r-1}{2}} (r+2m+1)!}{2^r \left(\frac{r-1}{2}\right)! \left(\frac{r+2m+1}{2}\right)!} d_r^m = \frac{(-1)^{\frac{n-m-1}{2}} (n+m+1)!}{2^{n-m} \left(\frac{n-m-1}{2}\right)! \left(\frac{n+m+1}{2}\right)!}$$

$(n-m)$  odd

(The normalization scheme 21.7.13 and 21.7.14 is also used in [21.10].)

Asymptotic Expansions for  $S_{mn}(c, \eta)$

21.7.17

$$S_{mn}(c, \eta) = (1-\eta^2)^{\frac{1}{2}} U_{mn}(c, \eta) \quad (c \rightarrow \infty)$$

$$U_{mn}(x) = \sum_{r=-\infty}^{\infty} h_r^l D_{l+r}(x) \quad l = n-m$$

where the  $D_r(x)$ 's are the parabolic cylinder functions (see chapter 19).

$$D_r(x) = (-1)^r e^{x^2/4} \frac{d^2}{dx^2} e^{-x^2/2} = 2^{-r/2} e^{-x^2/4} H_r\left(\frac{x}{\sqrt{2}}\right)$$

and the  $H_r(x)$  are the Hermite polynomials (see chapter 22). (For tables of  $h_{\pm r}^l/h_0^l$  see [21.4].)

Expansion of  $S_{mn}(c, \eta)$  in Powers of  $\eta$

21.7.18

$$S_{mn}(c, \eta) = (1-\eta^2)^{m/2} \sum_{r=0,1}^{\infty} p_r^{mn}(c) \eta^r$$

$$(r+1)(r+2)p_{r+2}^{mn}(c) - [r(r+2m+1) + m(m+1) - \lambda_{mn}(c)]p_r^{mn}(c) - c^2 p_{r-2}^{mn}(c) = 0$$

(The derivation of the transcendental equation for  $\lambda_{mn}$  is similar to the derivation of 21.7.4 from 21.7.3.)

Expansion of  $S_{mn}(c, \eta)$  in Powers of  $(1-\eta^2)$

21.7.19

$$S_{mn}(c, \eta) = (1-\eta^2)^{m/2} \sum_{k=0}^{\infty} c_{2k}^{mn} (1-\eta^2)^k \quad (n-m)$$

even

21.7.20

$$S_{mn}(c, \eta) = \eta(1-\eta^2)^{m/2} \sum_{k=0}^{\infty} c_{2k}^{mn} (1-\eta^2)^k \quad (n-m) \text{ odd}$$

$$c_{2k}^{mn} = \frac{1}{2^m k! (m+k)!} \sum_{r=k}^{\infty} \frac{(2m+2r)!}{(2r)!} (-r)_k \left(m+r+\frac{1}{2}\right)_k d_{2r}^{mn} \quad (n-m) \text{ even}$$

$$c_{2k}^{mn} = \frac{1}{2^m k! (m+k)!} \sum_{r=k}^{\infty} \frac{(2m+2r+1)!}{(2r+1)!} (-r)_k \left(m+r+\frac{3}{2}\right)_k d_{2r+1}^{mn} \quad (n-m) \text{ odd}$$

$$(\alpha)_k = \alpha(\alpha+1)(\alpha+2) \dots (\alpha+k+1)$$

(The  $d_r^{mn}$ 's are the coefficients in 21.7.1.)

**Prolate Angular Functions—Second Kind**

Expansion 21.7.2 ultimately leads to

21.7.21

$$S_{mn}^{(2)}(c, \eta) = \sum_{r=-2m, -2m+1}^{\infty} d_r^{mn} Q_{m+r}^{mn}(\eta) + \sum_{r=2m+2, 2m+1}^{\infty} d_{r-1}^{mn} P_{r-m-1}^{mn}(\eta)$$

(The coefficients  $d_r^{mn}$  are the same as in 21.7.1; the coefficients  $d_{r-1}^{mn}$  are tabulated in [21.4].)

**21.8. Oblate Angular Functions**

**Power Series Expansion for Eigenvalues**

21.8.1 
$$\lambda_{mn} = \sum_{k=0}^{\infty} (-1)^k l_k c^{2k}$$

where the  $l_k$ 's are the same as in 21.7.5.

**Asymptotic Expansion for Eigenvalues [21.4]**

21.8.2

$$\lambda_{mn} = -c^2 + 2c(2\nu + m + 1) - 2\nu(\nu + m + 1) - (m + 1) + \Lambda_{mn}$$

$$\nu = \frac{1}{2}(n - m) \text{ for } (n - m) \text{ even;}$$

$$\nu = \frac{1}{2}(n - m - 1) \text{ for } (n - m) \text{ odd}$$

$$\Lambda_{mn} = \sum_{k=1}^{\infty} \beta_k^{mn} c^{-k}$$

$$\beta_1^{mn} = -2^{-3}q(q^2 + 1 - m^2)$$

$$\beta_2^{mn} = -2^{-6}[5q^4 + 10q^2 + 1 - 2m^2(3q^2 + 1) + m^4]$$

$$\beta_3^{mn} = -2^{-9}q[33q^4 + 114q^2 + 37 - 2m^2(23q^2 + 25) + 13m^4]$$

$$\beta_4^{mn} = -2^{-10}[63q^6 + 340q^4 + 239q^2 + 14 - 10m^2(10q^4 + 23q^2 + 3) + m^4(39q^2 - 18) - 2m^6]$$

$$\beta_k^{mn} = \nu(\nu + m)a_k^{-1} + (\nu + 1)(\nu + m + 1)a_k^{+1}$$

$q = n + 1$  for  $(n - m)$  even;  $q = n$  for  $(n - m)$  odd

(For the definition of  $a_k^{\pm r}$  see 21.8.3.)

**Asymptotic Expansion for Oblate Angular Functions**

21.8.3

$$S_{mn}(-ic, \eta) \sim (1-\eta^2)^{m/2} \sum_{s=-\nu}^{\infty} A_s^{mn} \{ e^{-c(1-\eta)} L_{\nu+s}^{(m)} [2c(1-\eta)] + (-1)^{n-m} e^{-c(1+\eta)} L_{\nu+s}^{(m)} [2c(1+\eta)] \}$$

where the  $L_\nu^{(m)}(x)$  are Laguerre polynomials (see chapter 22) and

$$\frac{A_{\pm r}^{mn}}{A_0^{mn}} = \sum_{k=r}^{\infty} a_k^{\pm r}(m, n) c^{-k}$$

(Expressions of  $a_k^{\pm r}$  are given in [21.4].)

**21.9. Radial Spheroidal Wave Functions**

21.9.1

$$R_{mn}^{(p)}(c, \xi) = \left\{ \sum_{r=0,1}^{\infty} \frac{(2m+r)!}{r!} d_r^{mn} \right\}^{-1} \left( \frac{\xi^2 - 1}{\xi^2} \right)^{m/2} \cdot \sum_{r=0,1}^{\infty} i^{r+m-n} \frac{(2m+r)!}{r!} d_r^{mn} Z_{m+r}^{(p)}(c\xi)^*$$

$$Z_n^{(p)}(z) = \sqrt{\frac{\pi}{2z}} J_{n+\frac{1}{2}}(z) \quad (p=1)$$

$$= \sqrt{\frac{\pi}{2z}} Y_{n+\frac{1}{2}}(z) \quad (p=2)$$

( $J_{n+\frac{1}{2}}(z)$  and  $Y_{n+\frac{1}{2}}(z)$  are Bessel functions, order  $n + \frac{1}{2}$ , of the first and second kind respectively (see chapter 10).)

21.9.2 
$$R_{mn}^{(3)}(c, \xi) = R_{mn}^{(1)}(c, \xi) + iR_{mn}^{(2)}(c, \xi)$$

21.9.3 
$$R_{mn}^{(4)}(c, \xi) = R_{mn}^{(1)}(c, \xi) - iR_{mn}^{(2)}(c, \xi)$$

**Asymptotic Behavior of  $R_{mn}^{(1)}(c, \xi)$  and  $R_{mn}^{(2)}(c, \xi)$**

21.9.4 
$$R_{mn}^{(1)}(c, \xi) \xrightarrow{c\xi \rightarrow \infty} \frac{1}{c\xi} \cos [c\xi - \frac{1}{2}(n+1)\pi]$$

21.9.5 
$$R_{mn}^{(2)}(c, \xi) \xrightarrow{c\xi \rightarrow \infty} \frac{1}{c\xi} \sin [c\xi - \frac{1}{2}(n+1)\pi]$$

\*See page II.

## 21.10. Joining Factors for Prolate Spheroidal Wave Functions

## 21.10.1

$$S_{mn}^{(1)}(c, \xi) = \kappa_{mn}^{(1)}(c) R_{mn}^{(1)}(c, \xi)$$

$$\kappa_{mn}^{(1)}(c) = \frac{(2m+1)(n+m)! \sum_{r=0}^{\infty} d_r^{mn} (2m+r)! / r!}{2^{n+m} d_0^{mn}(c) c^m m! \left(\frac{n-m}{2}\right)! \left(\frac{n+m}{2}\right)!} \quad (n-m) \text{ even}$$

$$= \frac{(2m+3)(n+m+1)! \sum_{r=1}^{\infty} d_r^{mn} (2m+r)! / r!}{2^{n+m} d_1^{mn}(c) c^{m+1} m! \left(\frac{n-m-1}{2}\right)! \left(\frac{n+m+1}{2}\right)!} \quad (n-m) \text{ odd}$$

## 21.10.2

$$S_{mn}^{(2)}(c, \xi) = \kappa_{mn}^{(2)}(c) R_{mn}^{(2)}(c, \xi)$$

$$\kappa_{mn}^{(2)}(c) = \frac{2^{n-m} (2m)! \left(\frac{n-m}{2}\right)! \left(\frac{n+m}{2}\right)! d_{-2m}^{mn}(c)}{(2m-1)m!(n+m)! c^{m-1}} \sum_{r=0}^{\infty} \frac{(2m+r)!}{r!} d_r^{mn}(c) \quad (n-m) \text{ even}$$

$$= \frac{2^{n-m} (2m)! \left(\frac{n-m-1}{2}\right)! \left(\frac{n+m+1}{2}\right)! d_{-2m+1}^{mn}(c)}{(2m-3)(2m-1)m!(n+m+1)! c^{m-2}} \sum_{r=1}^{\infty} \frac{(2m+r)!}{r!} d_r^{mn}(c) \quad (n-m) \text{ odd}$$

(The expression for joining factors appropriate to the oblate case may be obtained from the above formulas by the transformation  $c \rightarrow -ic$ .)

## 21.11. Notation

## Notation for Prolate Spheroidal Wave Functions

|  | Ang. coord.             | Rad. coord.       | Independent variable | Ang. wave function       | Rad. wave function  | Eigenvalue              | Normalization of angular functions   | Remarks   |
|--|-------------------------|-------------------|----------------------|--------------------------|---|-------------------------|--|---|
| Stratton, Morse, Chu, Little and Corbató | $\eta$                  | $\xi$             | $h$                  | $S_{ml}(h, \eta)$        | $je_{ml}(h, \xi)$<br>$ne_{ml}(h, \xi)$<br>$he_{ml}(h, \xi)$ | $A_{ml}(h)$             | $S_{ml}(h, 1) = P_l^m(1)$  | $l = \text{Flammer's } n$<br>$A_{ml} = \lambda_{mn}$            |
| Flammer and this chapter                 | $\eta$                  | $\xi$             | $c$                  | $S_{mn}(c, \eta)$        | $R_{mn}^{(l)}(c, \xi)$                                      | $\lambda_{mn}(c)$       | $S_{mn}(c, 0) = P_n^m(0)$ ( $n-m$ ) even<br>$S_{mn}(c, 0) = P_n^{m'}(0)$ ( $n-m$ ) odd               |   |
| Chu and Stratton                         | $\eta$                  | $\xi$             | $c$                  | $S_{ml}^{(l)}(c, \eta)$  | $R_{ml}^{(l)}(c, \xi)$                                      | $A_{ml}$                | $S_{ml}^{(l)}(c, 0) = P_{m+l}^m(0)$ ( $l$ even)<br>$S_{ml}^{(l)}(c, 0) = P_{m+l}^{m'}(0)$ ( $l$ odd) | $l = \text{Flammer's } n - m$<br>$A_{ml} = -\lambda_{m, n-m}$   |
| Meixner and Schäfke                      | $\eta$                  | $\xi$             | $\gamma$             | $PS_n^m(\eta, \gamma^2)$ | $S_n^{m(l)}(\xi, \gamma^2)$                                 | $\lambda_n^m(\gamma^2)$ | $\int_{-1}^1 [PS_n^m(\eta, \gamma^2)]^2 d\eta$<br>$= \frac{2}{2n+1} \frac{(n+m)!}{(n-m)!}$           | $\lambda_n^m(\gamma^2) = \lambda_{mn}(c) - c^2$                 |
| Morse and Feshbach                       | $\eta = \cos \vartheta$ | $\xi = \cosh \mu$ | $h$                  | $S_{ml}(h, \eta)$        | $je_{ml}(h, \xi)$<br>$ne_{ml}(h, \xi)$<br>$he_{ml}(h, \xi)$ | $A_{ml}$                | $[(1-\eta^2)^{-m/2} S_{ml}(h, \eta)]_{\eta=1} = [(1-\eta^2)^{-m/2} P_l^m(\eta)]_{\eta=1}$            | $l = \text{Flammer's } n$<br>$A_{ml} = \lambda_{mn}$            |
| Page                                     | $\xi$                   | $\eta$            | $c$                  | $U_{lm}(\xi)$            | $v_{lm}(\eta)$<br>$p_{lm}(\eta)$<br>$q_{lm}(\eta)$          | $\alpha_{lm}$           | $[(1-\xi^2)^{-m/2} U_{lm}(\xi)]_{\xi=1} = 1$   | $l = \text{Flammer's } n$<br>$\alpha_{lm} = \lambda_{mn} - c^2$ |

## Notation for Oblate Spheroidal Wave Functions

|  |                         |                   |          |                           |  |                          |  |   |
|--|-------------------------|-------------------|----------|---------------------------|--|--------------------------|--|---|
| Stratton, Morse, Chu, Little and Corbató | $\eta$                  | $\xi$             | $g$      | $S_{ml}(ig, \eta)$        | $je_{ml}(ig, -i\xi)$   | $A_{ml}$                 | $S_{ml}(ig, 1) = P_l^m(1)$   | $l = \text{Flammer's } n$<br>$A_{ml} = \lambda_{mn}$            |
| Flammer and this chapter                 | $\eta$                  | $\xi$             | $c$      | $S_{mn}(-ic, \eta)$       | $R_{mn}^{(l)}(-ic, i\xi)$  | $\lambda_{mn}(-ic)$      | $S_{mn}(-ic, 0) = P_n^m(0)$ ( $n-m$ ) even<br>$S_{mn}(-ic, 0) = P_n^{m'}(0)$ ( $n-m$ ) odd               |   |
| Chu and Stratton                         | $\eta$                  | $\xi$             | $c$      | $S_{ml}^{(l)}(-ic, \eta)$ | $R_{ml}^{(l)}(-ic, i\xi)$  | $B_{ml}$                 | $S_{ml}^{(l)}(-ic, 0) = P_{m+l}^m(0)$ ( $l$ even)<br>$S_{ml}^{(l)}(-ic, 0) = P_{m+l}^{m'}(0)$ ( $l$ odd) | $l = \text{Flammer's } n - m$<br>$B_{ml} = -\lambda_{m, n-m}$   |
| Meixner and Schäfke                      | $\eta$                  | $\xi$             | $\gamma$ | $ps_n^m(\eta, -\gamma^2)$ | $S_n^{m(l)}(-i\xi, i\gamma^2)$                                       | $\lambda_n^m(-\gamma^2)$ | $\int_{-1}^1 [ps_n^m(\eta, -\gamma^2)]^2 d\eta$<br>$= \frac{2}{2n+1} \frac{(n+m)!}{(n-m)!}$              | $\lambda_n^m(-\gamma^2) = \lambda_{mn}(-ic) + c^2$              |
| Morse and Feshbach                       | $\eta = \cos \vartheta$ | $\xi = \sinh \mu$ | $g$      | $S_{ml}(ig, \eta)$        | $je_{ml}(ig, -i\xi)$<br>$ne_{ml}(ig, -i\xi)$<br>$he_{ml}(ig, -i\xi)$ | $A_{ml}$                 | $[(1-\eta^2)^{-m/2} S_{ml}(ig, \eta)]_{\eta=1} = [(1-\eta^2)^{-m/2} P_l^m(\eta)]_{\eta=1}$               | $l = \text{Flammer's } n$<br>$A_{ml} = \lambda_{mn}$            |
| Leitner and Spence                       | $\eta$                  | $\xi$             | $c$      | $U_{lm}(\eta)$            | $v_{lm}(\xi)$  | $\alpha_{lm}$            | $[(1-\eta^2)^{-m/2} U_{lm}(\eta)]_{\eta=1} = 1$  | $l = \text{Flammer's } n$<br>$\alpha_{lm} = \lambda_{mn} + c^2$ |

The notation in this chapter closely follows the notation in [21.4].

## References

- [21.1] M. Abramowitz, Asymptotic expansion of spheroidal wave functions, *J. Math. Phys.* **28**, 195-199 (1949).
- [21.2] G. Blanch, On the computation of Mathieu functions, *J. Math. Phys.* **25**, 1-20 (1946).
- [21.3] C. J. Bouwkamp, Theoretische en numerieke behandeling van de buiging door en ronde opening, Diss. Groningen, Groningen-Batavia, (1941).
- [21.4] C. Flammer, Spheroidal wave functions (Stanford Univ. Press, Stanford, Calif., 1957).
- [21.5] A. Leitner and R. D. Spence, The oblate spheroidal wave functions, *J. Franklin Inst.* **249**, 299-321 (1950).
- [21.6] J. Meixner and F. W. Schäfke, Mathiesche Funktionen und Sphäroidfunktionen (Springer-Verlag, Berlin, Göttingen, Heidelberg, Germany, 1954).
- [21.7] P. M. Morse and H. Feshbach, Methods of theoretical physics (McGraw-Hill Book Co., Inc., New York, N.Y., 1953).
- [21.8] L. Page, The electrical oscillations of a prolate spheroid, *Phys. Rev.* **65**, 98-117 (1944).
- [21.9] J. A. Stratton, P. M. Morse, L. J. Chu and R. A. Hutner, Elliptic cylinder and spheroidal wave functions (John Wiley & Sons, Inc., New York, N.Y., 1941).
- [21.10] J. A. Stratton, P. M. Morse, L. J. Chu, J. D. C. Little, and F. J. Corbató, Spheroidal wave functions (John Wiley & Sons, Inc., New York, N.Y., 1956).





# 22. Orthogonal Polynomials

URS W. HOCHSTRASSER<sup>1</sup>

## Contents

|   | Page |
|---|------|
| <b>Mathematical Properties</b> . . . . .  | 773  |
| 22.1. Definition of Orthogonal Polynomials . . . . .  | 773  |
| 22.2. Orthogonality Relations . . . . .   | 774  |
| 22.3. Explicit Expressions . . . . .  | 775  |
| 22.4. Special Values. . . . .   | 777  |
| 22.5. Interrelations . . . . .  | 777  |
| 22.6. Differential Equations . . . . .  | 781  |
| 22.7. Recurrence Relations . . . . .  | 782  |
| 22.8. Differential Relations . . . . .  | 783  |
| 22.9. Generating Functions . . . . .  | 783  |
| 22.10. Integral Representations . . . . .   | 784  |
| 22.11. Rodrigues' Formula . . . . .   | 785  |
| 22.12. Sum Formulas . . . . .   | 785  |
| 22.13. Integrals Involving Orthogonal Polynomials . . . . .   | 785  |
| 22.14. Inequalities . . . . .   | 786  |
| 22.15. Limit Relations . . . . .  | 787  |
| 22.16. Zeros . . . . .  | 787  |
| 22.17. Orthogonal Polynomials of a Discrete Variable . . . . .  | 788  |
| <b>Numerical Methods</b> . . . . .  | 788  |
| 22.18. Use and Extension of the Tables . . . . .  | 788  |
| 22.19. Least Square Approximations . . . . .  | 790  |
| 22.20. Economization of Series . . . . .  | 791  |
| <b>References</b> . . . . .   | 792  |
| <b>Table 22.1.</b> Coefficients for the Jacobi Polynomials $P_n^{(\alpha, \beta)}(x)$ . . . . .   | 793  |
| $n=0(1)6$   |      |
| <b>Table 22.2.</b> Coefficients for the Ultraspherical Polynomials $C_n^{(\alpha)}(x)$ and<br>for $x^n$ in Terms of $C_m^{(\alpha)}(x)$ . . . . . | 794  |
| $n=0(1)6$   |      |
| <b>Table 22.3.</b> Coefficients for the Chebyshev Polynomials $T_n(x)$ and for<br>$x^n$ in Terms of $T_m(x)$ . . . . .                            | 795  |
| $n=0(1)12$  |      |
| <b>Table 22.4.</b> Values of the Chebyshev Polynomials $T_n(x)$ . . . . .   | 795  |
| $n=0(1)12, x=.2(.2)1, 10D$  |      |
| <b>Table 22.5.</b> Coefficients for the Chebyshev Polynomials $U_n(x)$ and for<br>$x^n$ in Terms of $U_m(x)$ . . . . .                            | 796  |
| $n=0(1)12$  |      |
| <b>Table 22.6.</b> Values of the Chebyshev Polynomials $U_n(x)$ . . . . .   | 796  |
| $n=0(1)12, x=.2(.2)1, 10D$  |      |

<sup>1</sup> Guest Worker, National Bureau of Standards, from The American University. (Presently, Atomic Energy Commission, Switzerland.)

# 22. Orthogonal Polynomials

## Mathematical Properties

### 22.1. Definition of Orthogonal Polynomials

A system of polynomials  $f_n(x)$ , degree  $[f_n(x)] = n$ , is called orthogonal on the interval  $a \leq x \leq b$ , with respect to the weight function  $w(x)$ , if

#### 22.1.1

$$\int_a^b w(x) f_n(x) f_m(x) dx = 0 \quad (n \neq m; n, m = 0, 1, 2, \dots)$$

The weight function  $w(x)[w(x) \geq 0]$  determines the system  $f_n(x)$  up to a constant factor in each polynomial. The specification of these factors is referred to as standardization. For suitably standardized orthogonal polynomials we set

#### 22.1.2

$$\int_a^b w(x) f_n^2(x) dx = h_n, f_n(x) = k_n x^n + k'_n x^{n-1} + \dots \quad (n = 0, 1, 2, \dots)$$

These polynomials satisfy a number of relationships of the same general form. The most important ones are:

#### Differential Equation

$$22.1.3 \quad g_2(x) f_n'' + g_1(x) f_n' + a_n f_n = 0$$

where  $g_2(x)$ ,  $g_1(x)$  are independent of  $n$  and  $a_n$  a constant depending only on  $n$ .

#### Recurrence Relation

$$22.1.4 \quad f_{n+1} = (a_n + x b_n) f_n - c_n f_{n-1}$$

where

#### 22.1.5

$$b_n = \frac{k_{n+1}}{k_n}, \quad a_n = b_n \left( \frac{k'_{n+1}}{k_{n+1}} - \frac{k'_n}{k_n} \right), \quad c_n = \frac{k_{n+1} k_{n-1} h_n}{k_n^2 h_{n-1}}$$

#### Rodrigues' Formula

$$22.1.6 \quad f_n = \frac{1}{e_n w(x)} \frac{d^n}{dx^n} \{ w(x) [g(x)]^n \}$$

where  $g(x)$  is a polynomial in  $x$  independent of  $n$ . The system  $\left\{ \frac{df_n}{dx} \right\}$  consists again of orthogonal polynomials.

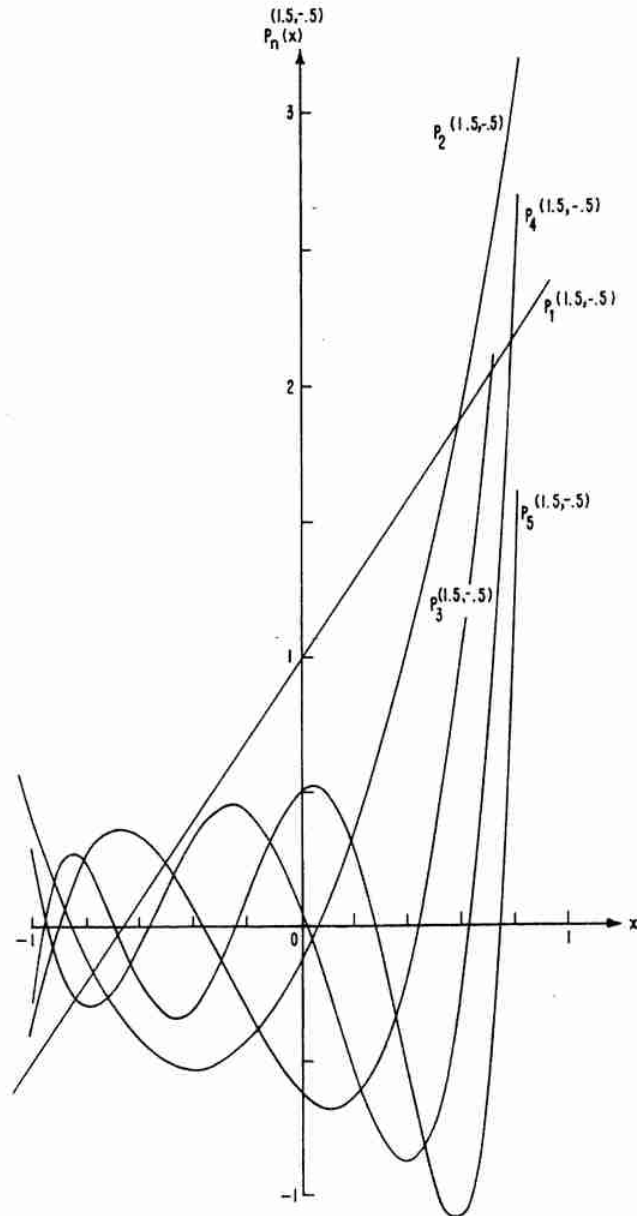

FIGURE 22.1. Jacobi Polynomials  $P_n^{(\alpha, \beta)}(x)$ ,  $\alpha = 1.5$ ,  $\beta = -0.5$ ,  $n = 1(1)5$ .

## 22.2. Orthogonality Relations

|          | $f_n(x)$                   | Name of Polynomial                   | $a$ | $b$ | $w(x)$  | Standardization   | $h_n$   | Remarks                   |
|----------|----------------------------|--------------------------------------|-----|-----|---|---|---|---------------------------|
| 22.2.1   | $P_n^{(\alpha, \beta)}(x)$ | Jacobi                               | -1  | 1   | $(1-x)^\alpha(1+x)^\beta$                     | $P_n^{(\alpha, \beta)}(1) = \binom{n+\alpha}{n}$                  | $\frac{2^{\alpha+\beta+1}}{2n+\alpha+\beta+1} \frac{\Gamma(n+\alpha+1)\Gamma(n+\beta+1)}{n!\Gamma(n+\alpha+\beta+1)}$ | $\alpha > -1, \beta > -1$ |
| 22.2.2   | $G_n(p, q, x)$             | Jacobi                               | 0   | 1   | $(1-x)^p x^q e^{-x}$                          | $k_n = 1$   | $\frac{n!\Gamma(n+q)\Gamma(n+p)\Gamma(n+p-q+1)}{(2n+p)\Gamma^2(2n+p)}$  | $p-q > -1, q > 0$         |
| 22.2.3   | $C_n^{(\alpha)}(x)$        | Ultraspherical<br>(Gegenbauer)       | -1  | 1   | $(1-x^2)^{\alpha-\frac{1}{2}}$                | $C_n^{(\alpha)}(1) = \binom{n+2\alpha-1}{n}$<br>$(\alpha \neq 0)$ | $\frac{\pi 2^{1-2\alpha} \Gamma(n+2\alpha)}{n!(n+\alpha)[\Gamma(\alpha)]^2}$ $\alpha \neq 0$                          | $\alpha > -\frac{1}{2}$   |
|          |                            |                                      |     |     |   | $C_n^{(0)}(1) = \frac{2}{n}$<br>$C_0^{(0)}(1) = 1$                | $\frac{2\pi}{n^2}$ $\alpha = 0$   |                           |
| 22.2.4   | $T_n(x)$                   | Chebyshev of the first kind          | -1  | 1   | $(1-x^2)^{-\frac{1}{2}}$                      | $T_n(1) = 1$  | $\begin{cases} \frac{\pi}{2} & n \neq 0 \\ \pi & n = 0 \end{cases}$   |                           |
| 22.2.5   | $U_n(x)$                   | Chebyshev of the second kind         | -1  | 1   | $(1-x^2)^{\frac{1}{2}}$                       | $U_n(1) = n+1$  | $\frac{\pi}{2}$   | 8                         |
| * 22.2.6 | $C_n(x)$                   | Chebyshev of the first kind          | -2  | 2   | $\left(1-\frac{x^2}{4}\right)^{-\frac{1}{2}}$ | $C_n(2) = 2$  | $\begin{cases} 4\pi & n \neq 0 \\ 8\pi & n = 0 \end{cases}$   |                           |
| * 22.2.7 | $S_n(x)$                   | Chebyshev of the second kind         | -2  | 2   | $\left(1-\frac{x^2}{4}\right)^{\frac{1}{2}}$  | $S_n(2) = n+1$  | $\pi$   |                           |
| 22.2.8   | $T_n^*(x)$                 | Shifted Chebyshev of the first kind  | 0   | 1   | $(x-x^2)^{-\frac{1}{2}}$                      | $T_n^*(1) = 1$  | $\begin{cases} \frac{\pi}{2} & n \neq 0 \\ \pi & n = 0 \end{cases}$   |                           |
| 22.2.9   | $U_n^*(x)$                 | Shifted Chebyshev of the second kind | 0   | 1   | $(x-x^2)^{\frac{1}{2}}$                       | $U_n^*(1) = n+1$  | $\frac{\pi}{8}$ *   |                           |
| 22.2.10  | $P_n(x)$                   | Legendre<br>(Spherical)              | -1  | 1   | 1   | $P_n(1) = 1$  | $\frac{2}{2n+1}$  |                           |
| 22.2.11  | $P_n^*(x)$                 | Shifted Legendre                     | 0   | 1   | 1   |   | $\frac{1}{2n+1}$  |                           |

\*See page II.

22.2. Orthogonality Relations—Continued

|           |                     |                      |           |          |                      |                           |                                 |               |
|-----------|---------------------|----------------------|-----------|----------|----------------------|---------------------------|---------------------------------|---------------|
| 22.2.12   | $L_n^{(\alpha)}(x)$ | Generalized Laguerre | 0         | $\infty$ | $e^{-x}x^\alpha$     | $k_n = \frac{(-1)^n}{n!}$ | $\frac{\Gamma(\alpha+n+1)}{n!}$ | $\alpha > -1$ |
| 22.2.13   | $L_n(x)$            | Laguerre             | 0         | $\infty$ | $e^{-x}$             | $k_n = \frac{(-1)^n}{n!}$ | 1                               |               |
| * 22.2.14 | $H_n(x)$            | Hermite              | $-\infty$ | $\infty$ | $e^{-x^2}$           | $e_n = (-1)^n$            | $\sqrt{\pi}2^n n!$              |               |
| * 22.2.15 | $He_n(x)$           | Hermite              | $-\infty$ | $\infty$ | $e^{-\frac{x^2}{2}}$ | $e_n = (-1)^n$            | $\sqrt{2\pi}n!$                 |               |

\*See page 11.

22.3. Explicit Expressions

$$f_n(x) = d_n \sum_{m=0}^N c_m g_m(x)$$

|         | $f_n(x)$                   | $N$                          | $d_n$   | $c_m$  | $g_m(x)$             | $k_n$  | Remarks                                |
|---------|----------------------------|------------------------------|---|--|----------------------|--|--|
| 22.3.1  | $P_n^{(\alpha, \beta)}(x)$ | $n$                          | $\frac{1}{2^n}$   | $\binom{n+\alpha}{m} \binom{n+\beta}{n-m}$                               | $(x-1)^{n-m}(x+1)^m$ | $\frac{1}{2^n} \binom{2n+\alpha+\beta}{n}$               | $\alpha > -1, \beta > -1$              |
| 22.3.2  | $P_n^{(\alpha, \beta)}(x)$ | $n$                          | $\frac{\Gamma(\alpha+n+1)}{n!\Gamma(\alpha+\beta+n+1)}$ | $\binom{n}{m} \frac{\Gamma(\alpha+\beta+n+m+1)}{2^m \Gamma(\alpha+m+1)}$ | $(x-1)^m$            | $\frac{1}{2^n} \binom{2n+\alpha+\beta}{n}$               | $\alpha > -1, \beta > -1$              |
| 22.3.3  | $G_n(p, q, x)$             | $n$                          | $\frac{\Gamma(q+n)}{\Gamma(p+2n)}$                      | $(-1)^m \binom{n}{m} \frac{\Gamma(p+2n-m)}{\Gamma(q+n-m)}$               | $x^{n-m}$            | 1  | $p-q > -1, q > 0$                      |
| 22.3.4  | $C_n^{(\alpha)}(x)$        | $\left[ \frac{n}{2} \right]$ | $\frac{1}{\Gamma(\alpha)}$                              | $(-1)^m \frac{\Gamma(\alpha+n-m)}{m!(n-2m)!}$                            | $(2x)^{n-2m}$        | $\frac{2^n}{n!} \frac{\Gamma(\alpha+n)}{\Gamma(\alpha)}$ | $\alpha > -\frac{1}{2}, \alpha \neq 0$ |
| 22.3.5  | $C_n^{(0)}(x)$             | $\left[ \frac{n}{2} \right]$ | 1   | $(-1)^m \frac{(n-m-1)!}{m!(n-2m)!}$                                      | $(2x)^{n-2m}$        | $\frac{2^n}{n} \quad n \neq 0$                           | $n \neq 0, C_0^{(0)}(1) = 1$           |
| 22.3.6  | $T_n(x)$                   | $\left[ \frac{n}{2} \right]$ | $\frac{n}{2}$   | $(-1)^m \frac{(n-m-1)!}{m!(n-2m)!}$                                      | $(2x)^{n-2m}$        | $2^{n-1}$  |  |
| 22.3.7  | $U_n(x)$                   | $\left[ \frac{n}{2} \right]$ | 1   | $(-1)^m \frac{(n-m)!}{m!(n-2m)!}$  | $(2x)^{n-2m}$        | $2^n$  |  |
| 22.3.8  | $P_n(x)$                   | $\left[ \frac{n}{2} \right]$ | $\frac{1}{2^n}$   | $(-1)^m \binom{n}{m} \binom{2n-2m}{n}$                                   | $x^{n-2m}$           | $\frac{(2n)!}{2^n (n!)^2}$                               |  |
| 22.3.9  | $L_n^{(\alpha)}(x)$        | $n$                          | 1   | $(-1)^m \binom{n+\alpha}{n-m} \frac{1}{m!}$                              | $x^m$                | $\frac{(-1)^n}{n!}$                                      | $\alpha > -1$                          |
| 22.3.10 | $H_n(x)$                   | $\left[ \frac{n}{2} \right]$ | $n!$  | $(-1)^m \frac{1}{m!(n-2m)!}$   | $(2x)^{n-2m}$        | $2^n$  | see 22.11                              |
| 22.3.11 | $He_n(x)$                  | $\left[ \frac{n}{2} \right]$ | $n!$  | $(-1)^m \frac{1}{m!2^m(n-2m)!}$  | $x^{n-2m}$           | 1  |  |

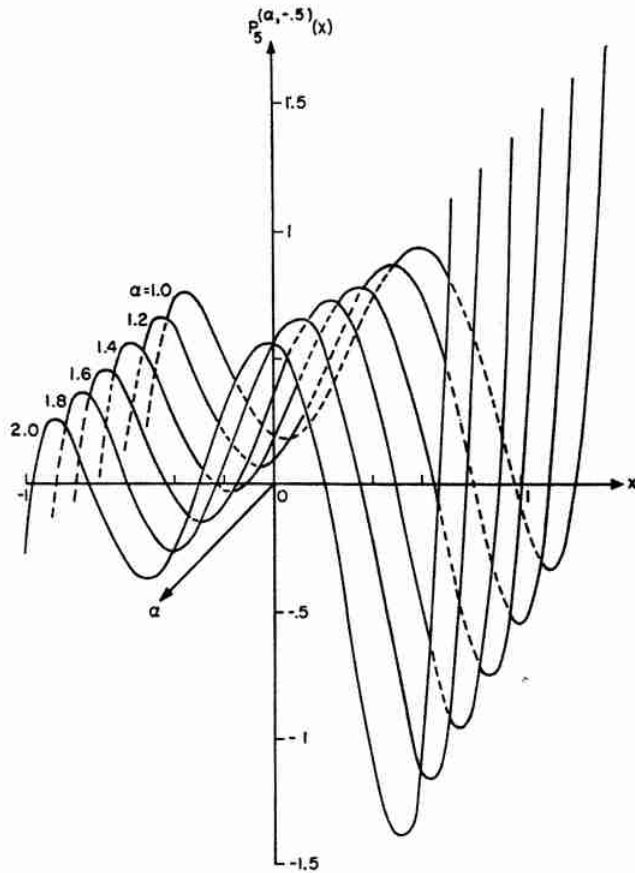

FIGURE 22.2. *Jacobi Polynomials*  $P_n^{(\alpha, \beta)}(x)$ ,  $\alpha=1(.2)2, \beta=-.5, n=5$ .

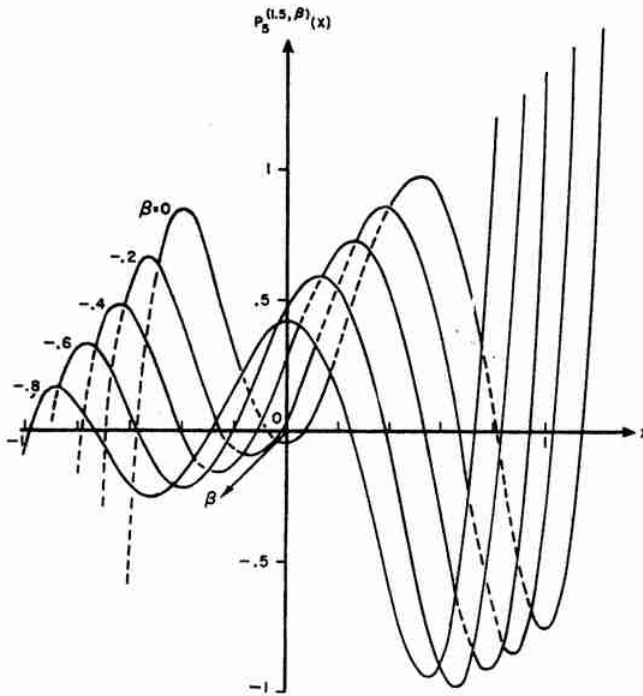

FIGURE 22.3. *Jacobi Polynomials*  $P_n^{(\alpha, \beta)}(x)$ ,  $\alpha=1.5, \beta=-.8(.2)0, n=5$ .

Explicit Expressions Involving Trigonometric Functions

$$f_n(\cos \theta) = \sum_{m=0}^n a_m \cos(n-2m)\theta$$

|         | $f_n(\cos \theta)$            | $a_m$   | Remarks         |
|---------|-------------------------------|---|-----------------|
| 22.3.12 | $C_n^{(\alpha)}(\cos \theta)$ | $\frac{\Gamma(\alpha+m)\Gamma(\alpha+n-m)}{m!(n-m)![\Gamma(\alpha)]^2}$ | $\alpha \neq 0$ |
| 22.3.13 | $P_n(\cos \theta)$            | $\frac{1}{4^n} \binom{2m}{m} \binom{2n-2m}{n-m}$                        |                 |

22.3.14  $C_n^{(0)}(\cos \theta) = \frac{2}{n} \cos n\theta$

22.3.15  $T_n(\cos \theta) = \cos n\theta$

22.3.16  $U_n(\cos \theta) = \frac{\sin(n+1)\theta}{\sin \theta}$

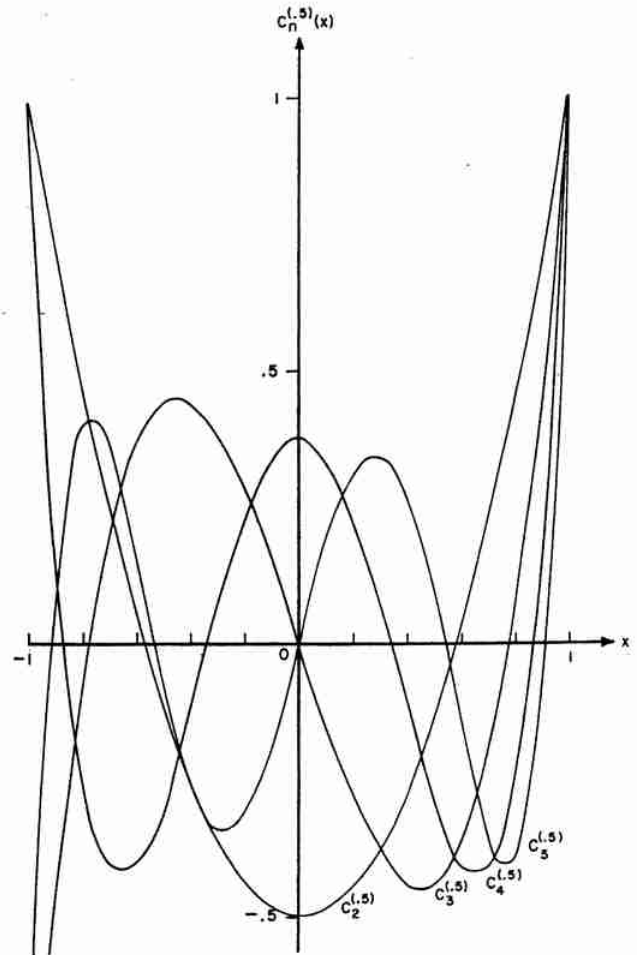

FIGURE 22.4. *Gegenbauer (Ultraspherical) Polynomials*  $C_n^{(\alpha)}(x)$ ,  $\alpha=.5, n=2(1)5$ .

22.4. Special Values

|        | $f_n(x)$                               | $f_n(-x)$                         | $f_n(1)$                 | $f_n(0)$  | $f_0(x)$ | $f_1(x)$  |
|--------|--|-----------------------------------|--------------------------|---|----------|---|
| 22.4.1 | $P_n^{(\alpha, \beta)}(x)$             | $(-1)^n P_n^{(\beta, \alpha)}(x)$ | $\binom{n+\alpha}{n}^*$  |   | 1        | $\frac{1}{2}[\alpha - \beta + (\alpha + \beta + 2)x]$ |
| 22.4.2 | $C_n^{(\alpha)}(x)$<br>$\alpha \neq 0$ | $(-1)^n C_n^{(\alpha)}(x)$        | $\binom{n+2\alpha-1}{n}$ | $\begin{cases} 0, n=2m+1 \\ (-1)^{n/2} \frac{\Gamma(\alpha+n/2)}{\Gamma(\alpha)(n/2)!}, n=2m \end{cases}$ | 1        | $2\alpha x$   |
| 22.4.3 | $C_n^{(0)}(x)$                         | $(-1)^n C_n^{(0)}(x)$             | $\frac{2}{n}, n \neq 0$  | $\begin{cases} \frac{(-1)^m}{m}, n=2m \neq 0 \\ 0, n=2m+1 \end{cases}$                                    | 1        | $2x$  |
| 22.4.4 | $T_n(x)$                               | $(-1)^n T_n(x)$                   | 1                        | $\begin{cases} (-1)^m, n=2m \\ 0, n=2m+1 \end{cases}$   | 1        | $x$   |
| 22.4.5 | $U_n(x)$                               | $(-1)^n U_n(x)$                   | $n+1$                    | $\begin{cases} (-1)^m, n=2m \\ 0, n=2m+1 \end{cases}$   | 1        | $2x$  |
| 22.4.6 | $P_n(x)$                               | $(-1)^n P_n(x)$                   | 1                        | $\begin{cases} \frac{(-1)^m}{4^m} \binom{2m}{m}, n=2m^* \\ 0, n=2m+1 \end{cases}$                         | 1        | $x$   |
| 22.4.7 | $L_n^{(\alpha)}(x)$                    |                                   |                          | $\binom{n+\alpha}{n}$   | 1        | $-x + \alpha + 1$                                     |
| 22.4.8 | $H_n(x)$                               | $(-1)^n H_n(x)$                   |                          | $\begin{cases} (-1)^m \frac{(2m)!}{m!}, n=2m \\ 0, n=2m+1 \end{cases}$                                    | 1        | $2x$  |

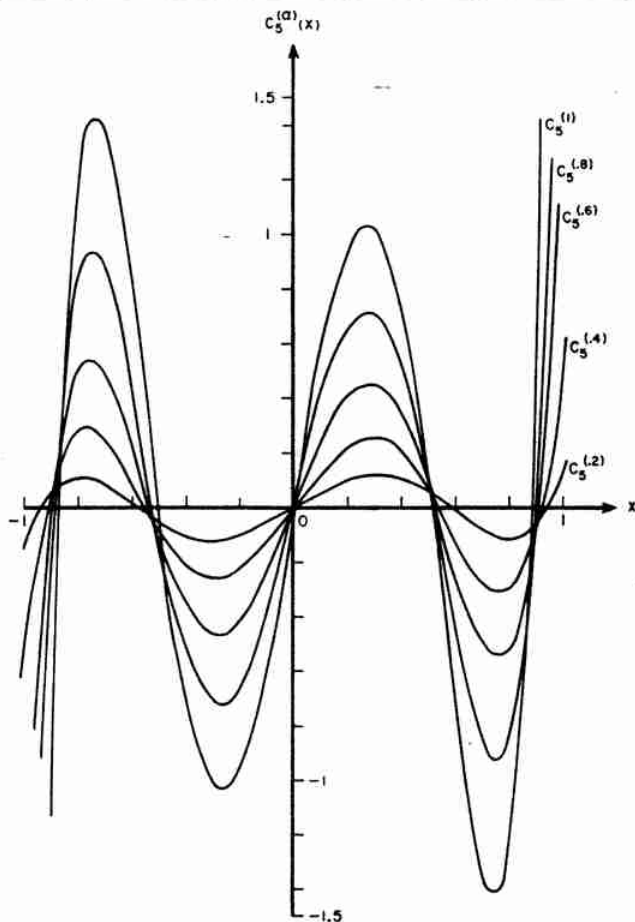

FIGURE 22.5. Gegenbauer (Ultraspherical) Polynomials  $C_n^{(\alpha)}(x)$ ,  $\alpha = .2(.2)1$ ,  $n = 5$ .

22.5. Interrelations

Interrelations Between Orthogonal Polynomials of the Same Family

Jacobi Polynomials

22.5.1

$$P_n^{(\alpha, \beta)}(x) = \frac{\Gamma(2n + \alpha + \beta + 1)}{n! \Gamma(n + \alpha + \beta + 1)} G_n\left(\alpha + \beta + 1, \beta + 1, \frac{x+1}{2}\right)$$

22.5.2

$$G_n(p, q, x) = \frac{n! \Gamma(n+p)}{\Gamma(2n+p)} P_n^{(p-q, q-1)}(2x-1)$$

(see [22.21]).

22.5.3

$$F_n(p, q, x) = (-1)^n n! \frac{\Gamma(q)}{\Gamma(q+n)} P_n^{(p-q, q-1)}(2x-1)$$

(see [22.13]).

Ultraspherical Polynomials

22.5.4 
$$C_n^{(0)}(x) = \lim_{\alpha \rightarrow 0} \frac{1}{\alpha} C_n^{(\alpha)}(x)$$

Chebyshev Polynomials

22.5.5 
$$T_n(x) = \frac{1}{2} C_n(2x) = T_n^*\left(\frac{1+x}{2}\right)$$

22.5.6 
$$T_n(x) = U_n(x) - xU_{n-1}(x)$$

\*See page II.

$$22.5.7 \quad T_n(x) = xU_{n-1}(x) - U_{n-2}(x)$$

$$22.5.8 \quad T_n(x) = \frac{1}{2} [U_n(x) - U_{n-2}(x)]$$

$$22.5.9 \quad U_n(x) = S_n(2x) = U_n^* \left( \frac{1+x}{2} \right)$$

$$22.5.10 \quad U_{n-1}(x) = \frac{1}{1-x^2} [xT_n(x) - T_{n+1}(x)]$$

$$22.5.11 \quad C_n(x) = 2T_n \left( \frac{x}{2} \right) = 2T_n^* \left( \frac{x+2}{4} \right)$$

$$22.5.12 \quad C_n(x) = S_n(x) - S_{n-2}(x)$$

$$22.5.13 \quad S_n(x) = U_n \left( \frac{x}{2} \right) = U_n^* \left( \frac{x+2}{4} \right)$$

$$22.5.14 \quad T_n^*(x) = T_n(2x-1) = \frac{1}{2} C_n(4x-2)$$

(see [22.22]).

$$22.5.15 \quad U_n^*(x) = S_n(4x-2) = U_n(2x-1)$$

(see [22.22]).

#### Generalized Laguerre Polynomials

$$22.5.16 \quad L_n^{(0)}(x) = L_n(x)$$

$$22.5.17 \quad L_n^{(m)}(x) = (-1)^m \frac{d^m}{dx^m} [L_{n+m}(x)]$$

#### Hermite Polynomials

$$22.5.18 \quad He_n(x) = 2^{-n/2} H_n \left( \frac{x}{\sqrt{2}} \right)$$

(see [22.20]).

$$22.5.19 \quad H_n(x) = 2^{n/2} He_n(x\sqrt{2})$$

(see [22.13], [22.20]).

#### Interrelations Between Orthogonal Polynomials of Different Families

##### Jacobi Polynomials

22.5.20

$$P_n^{(\alpha-\frac{1}{2}, \alpha-\frac{1}{2})}(x) = \frac{\Gamma(2\alpha)\Gamma(\alpha+n+\frac{1}{2})}{\Gamma(2\alpha+n)\Gamma(\alpha+\frac{1}{2})} C_n^{(\alpha)}(x)$$

22.5.21

$$P_n^{(\alpha, \frac{1}{2})}(x) = \frac{\left(\frac{1}{2}\right)_{n+1}}{\sqrt{\frac{x+1}{2}} (\alpha+\frac{1}{2})_{n+1}} C_{2n+1}^{(\alpha+\frac{1}{2})} \left( \sqrt{\frac{x+1}{2}} \right)$$

$$22.5.22 \quad P_n^{(\alpha, -\frac{1}{2})}(x) = \frac{\left(\frac{1}{2}\right)_n}{(\alpha+\frac{1}{2})_n} C_{2n}^{(\alpha+\frac{1}{2})} \left( \sqrt{\frac{x+1}{2}} \right)$$

$$22.5.23 \quad P_n^{(-\frac{1}{2}, -\frac{1}{2})}(x) = \frac{1}{4^n} \binom{2n}{n} T_n(x)$$

$$22.5.24 \quad P_n^{(0,0)}(x) = P_n(x)$$

#### Ultraspherical Polynomials

22.5.25

$$C_{2n}^{(\alpha)}(x) = \frac{\Gamma(\alpha+n)n!2^{2n}}{\Gamma(\alpha)(2n)!} P_n^{(\alpha-\frac{1}{2}, -\frac{1}{2})}(2x^2-1) \quad (\alpha \neq 0)$$

22.5.26

$$C_{2n+1}^{(\alpha)}(x) = \frac{\Gamma(\alpha+n+1)n!2^{2n+1}}{\Gamma(\alpha)(2n+1)!} xP_n^{(\alpha-\frac{1}{2}, \frac{1}{2})}(2x^2-1) \quad (\alpha \neq 0)$$

22.5.27

$$C_n^{(\alpha)}(x) = \frac{\Gamma(\alpha+\frac{1}{2})\Gamma(2\alpha+n)}{\Gamma(2\alpha)\Gamma(\alpha+n+\frac{1}{2})} P_n^{(\alpha-\frac{1}{2}, \alpha-\frac{1}{2})}(x) \quad (\alpha \neq 0)$$

22.5.28

$$C_n^{(0)}(x) = \frac{2}{n} T_n(x) = 2 \frac{(n-1)!}{\Gamma(n+\frac{1}{2})} \sqrt{\pi} P_n^{(-\frac{1}{2}, -\frac{1}{2})}(x) \quad *$$

#### Chebyshev Polynomials

$$22.5.29 \quad T_{2n+1}(x) = \frac{n!\sqrt{\pi}}{\Gamma(n+\frac{1}{2})} xP_n^{(-\frac{1}{2}, \frac{1}{2})}(2x^2-1)$$

$$22.5.30 \quad U_{2n}(x) = \frac{n!\sqrt{\pi}}{\Gamma(n+\frac{1}{2})} P_n^{(\frac{1}{2}, -\frac{1}{2})}(2x^2-1)$$

$$22.5.31 \quad T_n(x) = \frac{n!\sqrt{\pi}}{\Gamma(n+\frac{1}{2})} P_n^{(-\frac{1}{2}, -\frac{1}{2})}(x)$$

$$22.5.32 \quad U_n(x) = \frac{(n+1)!\sqrt{\pi}}{2\Gamma(n+\frac{3}{2})} P_n^{(\frac{1}{2}, \frac{1}{2})}(x)$$

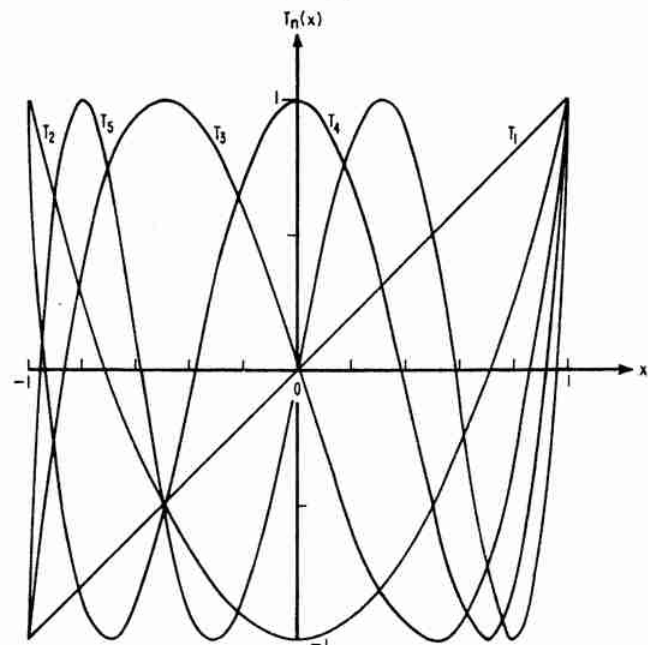

FIGURE 22.6. Chebyshev Polynomials  $T_n(x)$ ,  $n=1(1)5$ .

\*See page II.



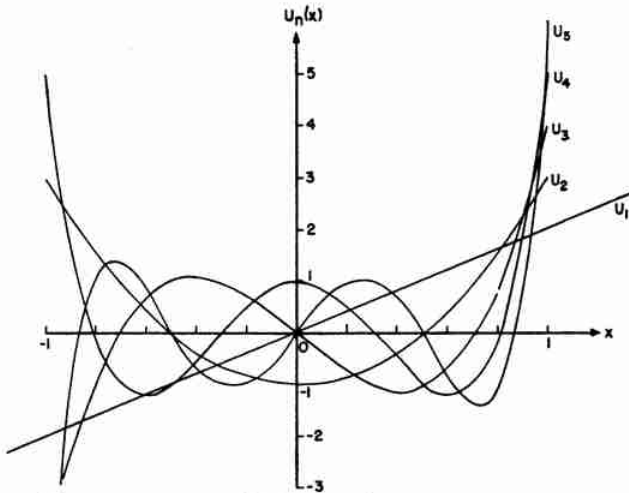

FIGURE 22.7. Chebyshev Polynomials  $U_n(x)$ ,  $n=1(1)5$ .

22.5.33  $T_n(x) = \frac{n}{2} C_n^{(0)}(x)$

22.5.34  $U_n(x) = C_n^{(1)}(x)$

**Legendre Polynomials**

22.5.35  $P_n(x) = P_n^{(0,0)}(x)$

22.5.36  $P_n(x) = C_n^{(1/2)}(x)$

22.5.37

$$\frac{d^m}{dx^m} [P_n(x)] = 1 \cdot 3 \dots (2m-1) C_{n-m}^{(m+1/2)}(x) \quad (m \leq n)$$

**Generalized Laguerre Polynomials**

22.5.38  $L_n^{(-1/2)}(x) = \frac{(-1)^n}{n! 2^{2n}} H_{2n}(\sqrt{x})$

22.5.39  $L_n^{(1/2)}(x) = \frac{(-1)^n}{n! 2^{2n+1} \sqrt{x}} H_{2n+1}(\sqrt{x})$

**Hermite Polynomials**

22.5.40  $H_{2m}(x) = (-1)^m 2^{2m} m! L_m^{(-1/2)}(x^2)$

22.5.41  $H_{2m+1}(x) = (-1)^m 2^{2m+1} m! x L_m^{(1/2)}(x^2)$

**Orthogonal Polynomials as Hypergeometric Functions** (see chapter 15)

$$f_n(x) = dF(a, b; c; g(x))$$

For each of the listed polynomials there are numerous other representations in terms of hypergeometric functions.

|         | $f_n(x)$                   | $d$   | $a$            | $b$                | $c$                  | $g(x)$            |
|---------|----------------------------|---|----------------|--------------------|----------------------|-------------------|
| 22.5.42 | $P_n^{(\alpha, \beta)}(x)$ | $\binom{n+\alpha}{n}$                                     | $-n$           | $n+\alpha+\beta+1$ | $\alpha+1$           | $\frac{1-x}{2}$   |
| 22.5.43 | $P_n^{(\alpha, \beta)}(x)$ | $\binom{2n+\alpha+\beta}{n} \left(\frac{x-1}{2}\right)^n$ | $-n$           | $-n-\alpha$        | $-2n-\alpha-\beta$   | $\frac{2}{1-x}$   |
| 22.5.44 | $P_n^{(\alpha, \beta)}(x)$ | $\binom{n+\alpha}{n} \left(\frac{1+x}{2}\right)^n$        | $-n$           | $-n-\beta$         | $\alpha+1$           | $\frac{x-1}{x+1}$ |
| 22.5.45 | $P_n^{(\alpha, \beta)}(x)$ | $\binom{n+\beta}{n} \left(\frac{x-1}{2}\right)^n$         | $-n$           | $-n-\alpha$        | $\beta+1$            | $\frac{x+1}{x-1}$ |
| 22.5.46 | $C_n^{(\alpha)}(x)$        | $\frac{\Gamma(n+2\alpha)}{n! \Gamma(2\alpha)}$            | $-n$           | $n+2\alpha$        | $\alpha+\frac{1}{2}$ | $\frac{1-x}{2}$   |
| 22.5.47 | $T_n(x)$                   | 1   | $-n$           | $n$                | $\frac{1}{2}$        | $\frac{1-x}{2}$   |
| 22.5.48 | $U_n(x)$                   | $n+1$   | $-n$           | $n+2$              | *                    | $\frac{1-x}{2}$   |
| 22.5.49 | $P_n(x)$                   | 1   | $-n$           | $n+1$              | 1                    | $\frac{1-x}{2}$   |
| 22.5.50 | $P_n(x)$                   | $\binom{2n}{n} \left(\frac{x-1}{2}\right)^n$              | $-n$           | $-n$               | $-2n$                | $\frac{2}{1-x}$   |
| 22.5.51 | $P_n(x)$                   | $\binom{2n}{n} \left(\frac{x}{2}\right)^n$                | $-\frac{n}{2}$ | $\frac{1-n}{2}$    | $\frac{1}{2}-n$      | $\frac{1}{x^2}$   |
| 22.5.52 | $P_{2n}(x)$                | $(-1)^n \frac{(2n)!}{2^{2n} (n!)^2}$                      | $-n$           | $n+\frac{1}{2}$    | $\frac{1}{2}$        | $x^2$             |
| 22.5.53 | $P_{2n+1}(x)$              | $(-1)^n \frac{(2n+1)!}{2^{2n} (n!)^2} x$                  | $-n$           | $n+\frac{3}{2}$    | $\frac{3}{2}$        | $x^2$             |

**Orthogonal Polynomials as Confluent Hypergeometric Functions** (see chapter 13)

$$22.5.54 \quad L_n^{(\alpha)}(x) = \binom{n+\alpha}{n} M(-n, \alpha+1, x)$$

**Orthogonal Polynomials as Parabolic Cylinder Functions** (see chapter 19)

$$22.5.55 \quad H_n(x) = 2^n U\left(\frac{1}{2} - \frac{1}{2}n, \frac{3}{2}, x^2\right)$$

$$22.5.56 \quad H_{2m}(x) = (-1)^m \frac{(2m)!}{m!} M\left(-m, \frac{1}{2}, x^2\right)$$

22.5.57

$$* H_{2m+1}(x) = (-1)^m \frac{(2m+1)!}{m!} 2x M\left(-m, \frac{3}{2}, x^2\right)$$

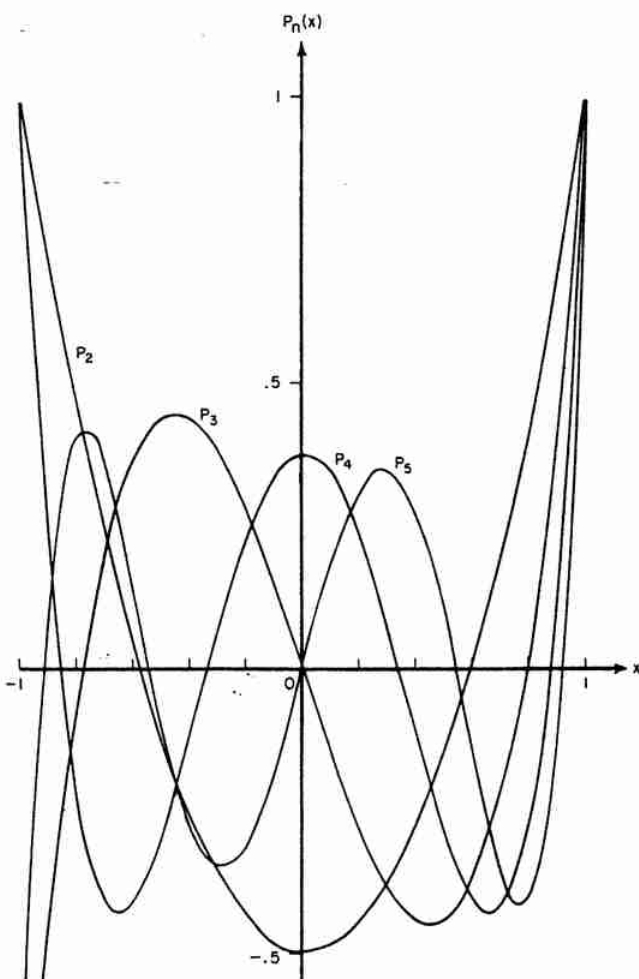

FIGURE 22.8. Legendre Polynomials  $P_n(x)$ ,  $n=2(1)5$ .

\*See page II.

22.5.58

$$H_n(x) = 2^{n/2} e^{x^2/2} D_n(\sqrt{2}x) = 2^{n/2} e^{x^2/2} U\left(-n - \frac{1}{2}, \sqrt{2}x\right)$$

$$22.5.59 \quad He_n(x) = e^{x^2/4} D_n(x) = e^{x^2/4} U\left(-n - \frac{1}{2}, x\right)$$

**Orthogonal Polynomials as Legendre Functions** (see chapter 8)

22.5.60

$$C_n^{(\alpha)}(x) =$$

$$\frac{\Gamma(\alpha + \frac{1}{2}) \Gamma(2\alpha + n)}{n! \Gamma(2\alpha)} \left[\frac{1}{4}(x^2 - 1)\right]^{1 - \frac{\alpha}{2}} P_{n+\alpha-1}^{(\frac{1}{2}, -\alpha)}(x) \quad (\alpha \neq 0)$$

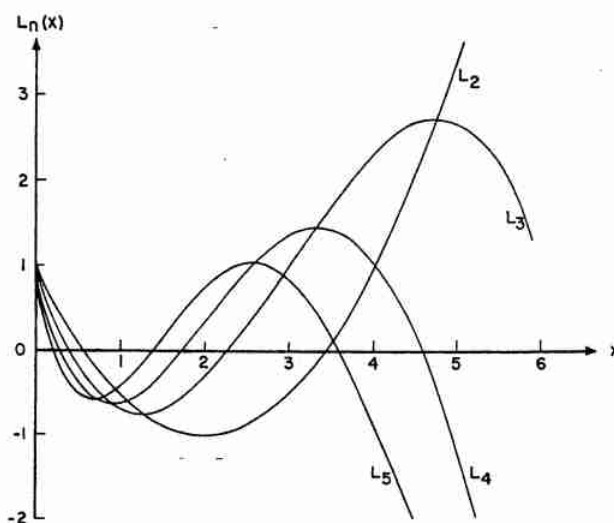

FIGURE 22.9. Laguerre Polynomials  $L_n(x)$ ,  $n=2(1)5$ .

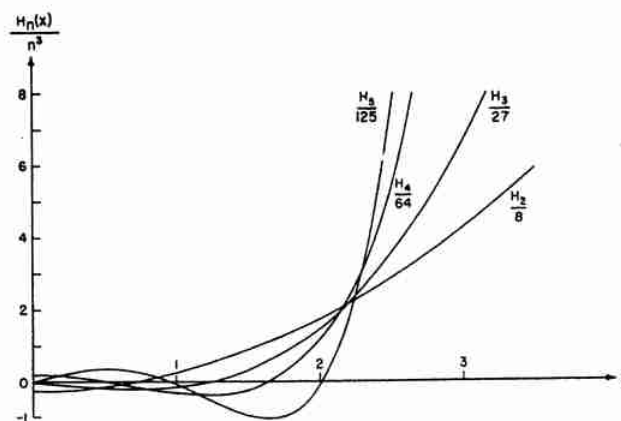

FIGURE 22.10. Hermite Polynomials  $\frac{H_n(x)}{n^3}$ ,  $n=2(1)5$ .

22.6. Differential Equations

$$g_2(x)y'' + g_1(x)y' + g_0(x)y = 0$$

|         | $y$  | $g_2(x)$ | $g_1(x)$                                 | $g_0(x)$  |
|---------|--|----------|--|---|
| 22.6.1  | $P_n^{(\alpha, \beta)}(x)$   | $1-x^2$  | $\beta - \alpha - (\alpha + \beta + 2)x$ | $n(n + \alpha + \beta + 1)$   |
| 22.6.2  | $(1-x)^\alpha(1+x)^\beta P_n^{(\alpha, \beta)}(x)$   | $1-x^2$  | $\alpha - \beta + (\alpha + \beta - 2)x$ | $(n+1)(n + \alpha + \beta)$   |
| 22.6.3  | $(1-x)^{\frac{\alpha+1}{2}}(1+x)^{\frac{\beta+1}{2}} P_n^{(\alpha, \beta)}(x)$   | 1        | 0  | $\frac{1}{4} \frac{1-\alpha^2}{(1-x)^2} + \frac{1}{4} \frac{1-\beta^2}{(1+x)^2}$<br>$+ \frac{2n(n + \alpha + \beta + 1) + (\alpha + 1)(\beta + 1)}{2(1-x^2)}$ |
| 22.6.4  | $\left(\sin \frac{x}{2}\right)^{\alpha+\frac{1}{2}} \left(\cos \frac{x}{2}\right)^{\beta+\frac{1}{2}} P_n^{(\alpha, \beta)}(\cos x)$ | 1        | 0  | $\frac{1-4\alpha^2}{16 \sin^2 \frac{x}{2}} + \frac{1-4\beta^2}{16 \cos^2 \frac{x}{2}}$<br>$+ \left(n + \frac{\alpha + \beta + 1}{2}\right)^2$                 |
| 22.6.5  | $C_n^{(\alpha)}(x)$  | $1-x^2$  | $-(2\alpha+1)x$                          | $n(n+2\alpha)$  |
| 22.6.6  | $(1-x^2)^{\alpha-\frac{1}{2}} C_n^{(\alpha)}(x)$   | $1-x^2$  | $(2\alpha-3)x$                           | $(n+1)(n+2\alpha-1)$  |
| 22.6.7  | $(1-x^2)^{\frac{\alpha}{2}-\frac{1}{4}} C_n^{(\alpha)}(x)$   | 1        | 0  | $\frac{(n+\alpha)^2}{1-x^2} + \frac{2+4\alpha-4\alpha^2+x^2}{4(1-x^2)^2}$   |
| 22.6.8  | $(\sin x)^\alpha C_n^{(\alpha)}(\cos x)$   | 1        | 0  | $(n+\alpha)^2 + \frac{\alpha(1-\alpha)}{\sin^2 x}$  |
| 22.6.9  | $T_n(x)$   | $1-x^2$  | $-x$                                     | $n^2$   |
| 22.6.10 | $T_n(\cos x)$  | 1        | 0  | $n^2$   |
| 22.6.11 | $\frac{1}{\sqrt{1-x^2}} T_n(x); U_{n-1}(x)$  | $1-x^2$  | $-3x$                                    | $n^2-1$   |
| 22.6.12 | $U_n(x)$   | $1-x^2$  | $-3x$                                    | $n(n+2)$  |
| 22.6.13 | $P_n(x)$   | $1-x^2$  | $-2x$                                    | $n(n+1)$  |
| 22.6.14 | $\sqrt{1-x^2} P_n(x)$  | 1        | 0  | $\frac{n(n+1)}{1-x^2} + \frac{1}{(1-x^2)^2}$  |
| 22.6.15 | $L_n^{(\alpha)}(x)$  | $x$      | $\alpha+1-x$                             | $n$   |
| 22.6.16 | $e^{-x} x^{\alpha/2} L_n^{(\alpha)}(x)$  | $x$      | $x+1$                                    | $n + \frac{\alpha}{2} + 1 - \frac{\alpha^2}{4x}$  |
| 22.6.17 | $e^{-x/2} x^{(\alpha+1)/2} L_n^{(\alpha)}(x)$  | 1        | 0  | $\frac{2n+\alpha+1}{2x} + \frac{1-\alpha^2}{4x^2} - \frac{1}{4}$  |
| 22.6.18 | $e^{-x^2/2} x^{\alpha+\frac{1}{2}} L_n^{(\alpha)}(x^2)$  | 1        | 0  | $4n+2\alpha+2-x^2 + \frac{1-4\alpha^2}{4x^2}$   |
| 22.6.19 | $H_n(x)$   | 1        | $-2x$                                    | $2n$  |
| 22.6.20 | $e^{-\frac{x^2}{2}} H_n(x)$  | 1        | 0  | $2n+1-x^2$  |
| 22.6.21 | $He_n(x)$  | 1        | $-x$                                     | $n$   |

\*See page II.

## 22.7. Recurrence Relations

Recurrence Relations With Respect to the Degree  $n$ 

$$a_{1n}f_{n+1}(x) = (a_{2n} + a_{3n}x)f_n(x) - a_{4n}f_{n-1}(x)$$

|         | $f_n$                      | $a_{1n}$  | $a_{2n}$                                | $a_{3n}$                   | $a_{4n}$  |
|---------|----------------------------|---|---|----------------------------|---|
| 22.7.1  | $P_n^{(\alpha, \beta)}(x)$ | $2(n+1)(n+\alpha+\beta+1)$<br>$(2n+\alpha+\beta)$ | $(2n+\alpha+\beta+1)(\alpha^2-\beta^2)$ | $(2n+\alpha+\beta)_3$      | $2(n+\alpha)(n+\beta)$<br>$(2n+\alpha+\beta+2)$ |
| 22.7.2  | $G_n(p, q, x)$             | $(2n+p-2)_4(2n+p-1)$                              | $-[2n(n+p)+q(p-1)]$<br>$(2n+p-2)_3$     | $(2n+p-2)_4$<br>$(2n+p-1)$ | $n(n+q-1)(n+p-1)$<br>$(n+p-q)(2n+p+1)$          |
| 22.7.3  | $C_n^{(\alpha)}(x)$        | $n+1$   | 0                                       | $2(n+\alpha)$              | $n+2\alpha-1$                                   |
| 22.7.4  | $T_n(x)$                   | 1   | 0                                       | 2                          | 1   |
| 22.7.5  | $U_n(x)$                   | 1   | 0                                       | 2                          | 1   |
| 22.7.6  | $S_n(x)$                   | 1   | 0                                       | 1                          | 1   |
| 22.7.7  | $C_n(x)$                   | 1   | 0                                       | 1                          | 1   |
| 22.7.8  | $T_n^*(x)$                 | 1   | -2                                      | 4                          | 1   |
| 22.7.9  | $U_n^*(x)$                 | 1   | -2                                      | 4                          | 1   |
| 22.7.10 | $P_n(x)$                   | $n+1$   | 0                                       | $2n+1$                     | $n$   |
| 22.7.11 | $P_n^*(x)$                 | $n+1$   | $-2n-1$                                 | $4n+2$                     | $n$   |
| 22.7.12 | $L_n^{(\alpha)}(x)$        | $n+1$   | $2n+\alpha+1$                           | -1                         | $n+\alpha$                                      |
| 22.7.13 | $H_n(x)$                   | 1   | 0                                       | 2                          | $2n$  |
| 22.7.14 | $He_n(x)$                  | 1   | 0                                       | 1                          | $n$   |

## Miscellaneous Recurrence Relations

## Jacobi Polynomials

22.7.15

$$\left(n + \frac{\alpha}{2} + \frac{\beta}{2} + 1\right) (1-x)P_n^{(\alpha+1, \beta)}(x) \\ = (n+\alpha+1)P_n^{(\alpha, \beta)}(x) - (n+1)P_{n+1}^{(\alpha, \beta)}(x)$$

22.7.16

$$\left(n + \frac{\alpha}{2} + \frac{\beta}{2} + 1\right) (1+x)P_n^{(\alpha, \beta+1)}(x) \\ = (n+\beta+1)P_n^{(\alpha, \beta)}(x) + (n+1)P_{n+1}^{(\alpha, \beta)}(x)$$

22.7.17

$$(1-x)P_n^{(\alpha+1, \beta)}(x) + (1+x)P_n^{(\alpha, \beta+1)}(x) = 2P_n^{(\alpha, \beta)}(x)$$

22.7.18

$$(2n+\alpha+\beta)P_n^{(\alpha-1, \beta)}(x) = (n+\alpha+\beta)P_n^{(\alpha, \beta)}(x) \\ - (n+\beta)P_{n-1}^{(\alpha, \beta)}(x)$$

22.7.19

$$(2n+\alpha+\beta)P_n^{(\alpha, \beta-1)}(x) = (n+\alpha+\beta)P_n^{(\alpha, \beta)}(x) \\ + (n+\alpha)P_{n-1}^{(\alpha, \beta)}(x)$$

$$22.7.20 \quad P_n^{(\alpha, \beta-1)}(x) - P_n^{(\alpha-1, \beta)}(x) = P_{n-1}^{(\alpha, \beta)}(x)$$

## Ultraspherical Polynomials

22.7.21

$$2\alpha(1-x^2)C_{n-1}^{(\alpha+1)}(x) = (2\alpha+n-1)C_{n-1}^{(\alpha)}(x) - nx C_n^{(\alpha)}(x)$$

22.7.22

$$= (n+2\alpha)x C_n^{(\alpha)}(x) \\ - (n+1)C_{n+1}^{(\alpha)}(x)$$

$$22.7.23 \quad (n+\alpha)C_{n+1}^{(\alpha-1)}(x) = (\alpha-1)[C_{n+1}^{(\alpha)}(x) - C_{n-1}^{(\alpha)}(x)]$$

## Chebyshev Polynomials

22.7.24

$$2T_m(x)T_n(x) = T_{n+m}(x) + T_{n-m}(x) \quad (n \geq m) \quad *$$

22.7.25

$$2(x^2-1)U_{m-1}(x)U_{n-1}(x) = T_{n+m}(x) - T_{n-m}(x) \quad (n \geq m)$$

22.7.26

$$2T_m(x)U_{n-1}(x) = U_{n+m-1}(x) + U_{n-m-1}(x) \quad (n > m)$$

22.7.27

$$2T_n(x)U_{m-1}(x) = U_{n+m-1}(x) - U_{n-m-1}(x) \quad (n > m)$$

$$22.7.28 \quad 2T_n(x)U_{n-1}(x) = U_{2n-1}(x)$$

\*See page II.

Generalized Laguerre Polynomials

22.7.29

$$L_n^{(\alpha+1)}(x) = \frac{1}{x} [(x-n)L_n^{(\alpha)}(x) + (\alpha+n)L_{n-1}^{(\alpha)}(x)]$$

22.7.30

$$L_n^{(\alpha-1)}(x) = L_n^{(\alpha)}(x) - L_{n-1}^{(\alpha)}(x)$$

22.7.31

$$L_n^{(\alpha+1)}(x) = \frac{1}{x} [(n+\alpha+1)L_n^{(\alpha)}(x) - (n+1)L_{n+1}^{(\alpha)}(x)]$$

22.7.32

$$L_n^{(\alpha-1)}(x) = \frac{1}{n+\alpha} [(n+1)L_{n+1}^{(\alpha)}(x) - (n+1-x)L_n^{(\alpha)}(x)]$$

22.8. Differential Relations

$$g_1(x) \frac{d}{dx} f_n(x) = g_1(x) f_n'(x) + g_0(x) f_{n-1}(x)$$

|        | $f_n$                      | $g_2$                            | $g_1$  | $g_0$                      |
|--------|----------------------------|----------------------------------|--|----------------------------|
| 22.8.1 | $P_n^{(\alpha, \beta)}(x)$ | $(2n + \alpha + \beta)(1 - x^2)$ | $n[\alpha - \beta - (2n + \alpha + \beta)x]$ | $2(n + \alpha)(n + \beta)$ |
| 22.8.2 | $C_n^{(\alpha)}(x)$        | $1 - x^2$                        | $-nx$  | $n + 2\alpha - 1$          |
| 22.8.3 | $T_n(x)$                   | $1 - x^2$                        | $-nx$  | $n$                        |
| 22.8.4 | $U_n(x)$                   | $1 - x^2$                        | $-nx$  | $n + 1$                    |
| 22.8.5 | $P_n(x)$                   | $1 - x^2$                        | $-nx$  | $n$                        |
| 22.8.6 | $L_n^{(\alpha)}(x)$        | $x$                              | $n$  | $-(n + \alpha)$            |
| 22.8.7 | $H_n(x)$                   | $1$                              | $0$  | $2n$                       |
| 22.8.8 | $He_n(x)$                  | $1$                              | $0$  | $n$                        |

22.9. Generating Functions

$$g(x, z) = \sum_{n=0}^{\infty} a_n f_n(x) z^n$$

$$R = \sqrt{1 - 2xz + z^2}$$

|         | $f_n(x)$                   | $a_n$  | $g(x, z)$   | Remarks                                |
|---------|----------------------------|--|---|--|
| 22.9.1  | $P_n^{(\alpha, \beta)}(x)$ | $2^{-\alpha-\beta}$  | $R^{-1}(1-z+R)^{-\alpha}(1+z+R)^{-\beta}$   | $ z  < 1$                              |
| 22.9.2  | $C_n^{(\alpha)}(x)$        | $\frac{2^{1-\alpha} \Gamma(\alpha + \frac{1}{2} + n) \Gamma(2\alpha)}{\Gamma(\alpha + \frac{1}{2}) \Gamma(2\alpha + n)}$ | $R^{-1}(1-xz+R)^{1-\alpha}$   | $ z  < 1, \alpha \neq 0$               |
| 22.9.3  | $C_n^{(\alpha)}(x)$        | $1$  | $R^{-2\alpha}$  | $ z  < 1, \alpha \neq 0$               |
| 22.9.4  | $C_n^{(0)}(x)$             | $1$  | $-\ln R^2$  | $ z  < 1$                              |
| 22.9.5  | $C_n^{(\alpha)}(x)$        | $\frac{\Gamma(2\alpha)}{\Gamma(\alpha + \frac{1}{2}) \Gamma(2\alpha + n)}$   | $e^{z \cos \theta} \left(\frac{z}{2} \sin \theta\right)^{1-\alpha} J_{\alpha-1/2}(z \sin \theta)$ | $x = \cos \theta$                      |
| 22.9.6  | $T_n(x)$                   | $2$  | $\left(\frac{1-z^2}{R^2} + 1\right)$  | $-1 < x < 1$<br>$ z  < 1$              |
| 22.9.7  | $T_n(x)$                   | $\frac{\sqrt{2}}{4^n} \binom{2n}{n}$   | $R^{-1}(1-xz+R)^{1/2}$  | $-1 < x < 1$<br>$ z  < 1$              |
| 22.9.8  | $T_n(x)$                   | $\frac{1}{n}$  | $1 - \frac{1}{2} \ln R^2$   | $a_0 = 1$<br>$-1 < x < 1$<br>$ z  < 1$ |
| 22.9.9  | $T_n(x)$                   | $1$  | $\frac{1-xz}{R^2}$  | $-1 < x < 1$<br>$ z  < 1$              |
| 22.9.10 | $U_n(x)$                   | $1$  | $R^{-2}$  | $-1 < x < 1$<br>$ z  < 1$              |
| 22.9.11 | $U_n(x)$                   | $\frac{\sqrt{2}}{4^{n+1}} \binom{2n+2}{n+1}$   | $\frac{1}{R} (1-xz+R)^{-1/2}$ *   | $-1 < x < 1$<br>$ z  < 1$              |

\*See page II.

22.9. Generating Functions—Continued

$$g(x, z) = \sum_{n=0}^{\infty} a_n f_n(x) z^n \quad R = \sqrt{1 - 2xz + z^2}$$

|         | $f_n(x)$            | $a_n$                              | $g(x, z)$   | Remarks                   |
|---------|---------------------|------------------------------------|---|---------------------------|
| 22.9.12 | $P_n(x)$            | 1                                  | $R^{-1}$  | $-1 < x < 1$<br>$ z  < 1$ |
| 22.9.13 | $P_n(x)$            | $\frac{1}{n!}$                     | $e^x \cos x J_0(z \sin \theta)$                       | $x = \cos \theta$         |
| 22.9.14 | $S_n(x)$            | 1                                  | $(1 - xz + z^2)^{-1}$                                 | $-2 < x < 2$<br>$ z  < 1$ |
| 22.9.15 | $L_n^{(\alpha)}(x)$ | 1                                  | $(1 - z)^{-\alpha-1} \exp\left(\frac{xz}{z-1}\right)$ | $ z  < 1$                 |
| 22.9.16 | $L_n^{(\alpha)}(x)$ | $\frac{1}{\Gamma(n + \alpha + 1)}$ | $(xz)^{-1} e^x J_\alpha[2(xz)^{1/2}]$                 |                           |
| 22.9.17 | $H_n(x)$            | $\frac{1}{n!}$                     | $e^{2xz - z^2}$                                       |                           |
| 22.9.18 | $H_{2n}(x)$         | $\frac{(-1)^n}{(2n)!}$             | $e^x \cos(2x\sqrt{z})$ *                              |                           |
| 22.9.19 | $H_{2n+1}(x)$       | $\frac{(-1)^n}{(2n+1)!}$           | $z^{-1/2} e^x \sin(2x\sqrt{z})$ *                     |                           |

22.10. Integral Representations

Contour Integral Representations

$f_n(x) = \frac{g_0(x)}{2\pi i} \int_C [g_1(z, x)]^n g_2(z, x) dz$  where  $C$  is a closed contour taken around  $z = a$  in the positive sense

|         | $f_n(x)$                   | $g_0(x)$                             | $g_1(z, x)$              | $g_2(z, x)$                                      | $a$ | Remarks  |
|---------|----------------------------|--------------------------------------|--------------------------|--|-----|--|
| 22.10.1 | $P_n^{(\alpha, \beta)}(x)$ | $\frac{1}{(1-x)^\alpha (1+x)^\beta}$ | $\frac{z^2 - 1}{2(z-x)}$ | $\frac{(1-z)^\alpha (1+z)^\beta}{z-x}$           | $x$ | $\pm 1$ outside $C$                                      |
| 22.10.2 | $C_n^{(\alpha)}(x)$        | 1                                    | $1/z$                    | $(1 - 2xz + z^2)^{-\alpha} z^{-1}$               | 0   | Both zeros of $1 - 2xz + z^2$ outside $C$ , $\alpha > 0$ |
| 22.10.3 | $T_n(x)$                   | 1/2                                  | $1/z$                    | $\frac{1 - z^2}{z(1 - 2xz + z^2)}$               | 0   | Both zeros of $1 - 2xz + z^2$ outside $C$                |
| 22.10.4 | $U_n(x)$                   | 1                                    | $1/z$                    | $\frac{1}{z(1 - 2xz + z^2)}$                     | 0   | Both zeros of $1 - 2xz + z^2$ outside $C$                |
| 22.10.5 | $P_n(x)$                   | 1                                    | $1/z$                    | $\frac{1}{z} (1 - 2xz + z^2)^{-1/2}$             | 0   | Both zeros of $1 - 2xz + z^2$ outside $C$                |
| 22.10.6 | $P_n(x)$                   | $\frac{1}{2^n}$                      | $\frac{z^2 - 1}{z - x}$  | $\frac{1}{z - x}$                                | $x$ |  |
| 22.10.7 | $L_n^{(\alpha)}(x)$        | $e^x x^{-\alpha}$                    | $\frac{z}{z - x}$        | $\frac{z^\alpha}{z - x} e^{-x}$                  | $x$ | Zero outside $C$   |
| 22.10.8 | $L_n^{(\alpha)}(x)$        | 1                                    | $1 + \frac{x}{z}$        | $e^{-x} \left(1 + \frac{x}{z}\right)^\alpha 1/z$ | 0   | $z = -x$ outside $C$                                     |
| 22.10.9 | $H_n(x)$                   | $n!$                                 | $1/z$                    | $\frac{e^{2xz - z^2}}{z}$                        | 0   |  |

Miscellaneous Integral Representations

22.10.10  $C_n^{(\alpha)}(x) = \frac{2^{(1-2\alpha)} \Gamma(n+2\alpha)}{n! [\Gamma(\alpha)]^2} \int_0^\pi [x + \sqrt{x^2 - 1} \cos \phi]^n (\sin \phi)^{2\alpha-1} d\phi \quad (\alpha > 0)$

22.10.11  $C_n^{(\alpha)}(\cos \theta) = \frac{2^{1-\alpha} \Gamma(n+2\alpha)}{n! [\Gamma(\alpha)]^2} (\sin \theta)^{1-2\alpha} \int_0^\theta \frac{\cos(n+\alpha)\phi}{(\cos \phi - \cos \theta)^{1-\alpha}} d\phi \quad (\alpha > 0)$

\*See page II.

22.10.12  $P_n(\cos \theta) = \frac{1}{\pi} \int_0^\pi (\cos \theta + i \sin \theta \cos \phi)^n d\phi$

22.10.14  $L_n^{(\alpha)}(x) = \frac{e^x x^{-\alpha}}{n!} \int_0^\infty e^{-t} t^{n+\frac{\alpha}{2}} J_\alpha(2\sqrt{tx}) dt$

22.10.13  $P_n(\cos \theta) = \frac{\sqrt{2}}{\pi} \int_\theta^\pi \frac{\sin(n+\frac{1}{2})\phi d\phi}{(\cos \theta - \cos \phi)^{\frac{1}{2}}}$

22.10.15  $H_n(x) = e^{x^2} \frac{2^{n+1}}{\sqrt{\pi}} \int_0^\infty e^{-t^2} t^n \cos\left(2xt - \frac{n}{2}\pi\right) dt$

22.11. Rodrigues' Formula

$$f_n(x) = \frac{1}{a_n \rho(x)} \frac{d^n}{dx^n} \{ \rho(x) (g(x))^n \}$$

The polynomials given in the following table are the only orthogonal polynomials which satisfy this formula.

|         | $f_n(x)$                   | $a_n$   | $\rho(x)$                      | $g(x)$  |
|---------|----------------------------|---|--------------------------------|---------|
| 22.11.1 | $P_n^{(\alpha, \beta)}(x)$ | $(-1)^n 2^n n!$   | $(1-x)^\alpha (1+x)^\beta$     | $1-x^2$ |
| 22.11.2 | $C_n^{(\alpha)}(x)$        | $(-1)^n 2^n n! \frac{\Gamma(2\alpha)\Gamma(\alpha+n+\frac{1}{2})}{\Gamma(\alpha+\frac{1}{2})\Gamma(n+2\alpha)}$ | $(1-x^2)^{\alpha-\frac{1}{2}}$ | $1-x^2$ |
| 22.11.3 | $T_n(x)$                   | $(-1)^n 2^n \frac{\Gamma(n+\frac{1}{2})}{\sqrt{\pi}}$   | $(1-x^2)^{-\frac{1}{2}}$       | $1-x^2$ |
| 22.11.4 | $U_n(x)$                   | $(-1)^n 2^{n+1} \frac{\Gamma(n+\frac{1}{2})}{(n+1)\sqrt{\pi}}$  | $(1-x^2)^{\frac{1}{2}}$        | $1-x^2$ |
| 22.11.5 | $P_n(x)$                   | $(-1)^n 2^n n!$   | 1                              | $1-x^2$ |
| 22.11.6 | $L_n^{(\alpha)}(x)$        | $n!$  | $e^{-x} x^\alpha$              | $x$     |
| 22.11.7 | $H_n(x)$                   | $(-1)^n$  | $e^{-x^2}$                     | 1       |
| 22.11.8 | $He_n(x)$                  | $(-1)^n$  | $e^{-x^2/2}$                   | 1       |

22.12. Sum Formulas

Christoffel-Darboux Formula

22.12.1

$$\sum_{m=0}^n \frac{1}{h_m} f_m(x) f_m(y) = \frac{k_n}{k_{n+1} h_n} \frac{f_{n+1}(x) f_n(y) - f_n(x) f_{n+1}(y)}{x-y}$$

Miscellaneous Sum Formulas (Only a Limited Selection Is Given Here.)

22.12.2  $\sum_{m=0}^n T_{2m}(x) = \frac{1}{2} [1 + U_{2n}(x)]$

22.12.3  $\sum_{m=0}^{n-1} T_{2m+1}(x) = \frac{1}{2} U_{2n-1}(x)$

22.12.4  $\sum_{m=0}^n U_{2m}(x) = \frac{1 - T_{2n+2}(x)}{2(1-x^2)}$

22.12.5  $\sum_{m=0}^{n-1} U_{2m+1}(x) = \frac{x - T_{2n+1}(x)}{2(1-x^2)}$

22.12.6  $\sum_{m=0}^n L_m^{(\alpha)}(x) L_{n-m}^{(\beta)}(y) = L_n^{(\alpha+\beta+1)}(x+y)$

22.12.7  $\sum_{m=0}^n \binom{n+\alpha}{m} \mu^{n-m} (1-\mu)^m L_{n-m}^{(\alpha)}(x) = L_n^{(\alpha)}(\mu x)$

22.12.8

$$H_n(x+y) = \frac{1}{2^{n/2}} \sum_{k=0}^n \binom{n}{k} H_k(\sqrt{2}x) H_{n-k}(\sqrt{2}y)$$

22.13. Integrals Involving Orthogonal Polynomials

22.13.1

$$2n \int_0^x (1-y)^\alpha (1+y)^\beta P_n^{(\alpha, \beta)}(y) dy = P_{n-1}^{(\alpha+1, \beta+1)}(0) - (1-x)^{\alpha+1} (1+x)^{\beta+1} P_{n-1}^{(\alpha+1, \beta+1)}(x)$$

22.13.2

$$\frac{n(2\alpha+n)}{2\alpha} \int_0^x (1-y^2)^{\alpha-\frac{1}{2}} C_n^{(\alpha)}(y) dy = C_{n-1}^{(\alpha+1)}(0) - (1-x^2)^{\alpha+\frac{1}{2}} C_{n-1}^{(\alpha+1)}(x)$$

22.13.3

$$\int_{-1}^1 \frac{T_n(y) dy}{(y-x)\sqrt{1-y^2}} = \pi U_{n-1}(x)$$

22.13.4

$$\int_{-1}^1 \frac{\sqrt{1-y^2} U_{n-1}(y) dy}{(y-x)} = -\pi T_n(x) \quad *$$

22.13.5

$$\int_{-1}^1 (1-x)^{-1/2} P_n(x) dx = \frac{2^{3/2}}{2n+1} \quad *$$

22.13.6

$$\int_0^\pi P_{2n}(\cos \theta) d\theta = \frac{\pi}{16^n} \binom{2n}{n}$$

22.13.7

$$\int_0^\pi P_{2n+1}(\cos \theta) \cos \theta d\theta = \frac{\pi}{4^{2n+1}} \binom{2n}{n} \binom{2n+2}{n+1}$$

\*See page II.



## 22.13.8

$$\int_0^1 x^\lambda P_{2n}(x) dx = \frac{(-1)^n \Gamma\left(n - \frac{\lambda}{2}\right) \Gamma\left(\frac{1}{2} + \frac{\lambda}{2}\right)}{2\Gamma\left(-\frac{\lambda}{2}\right) \Gamma\left(n + \frac{3}{2} + \frac{\lambda}{2}\right)} \quad (\lambda > -1)$$

## 22.13.9

$$\int_0^1 x^\lambda P_{2n+1}(x) dx = \frac{(-1)^n \Gamma\left(n + \frac{1}{2} - \frac{\lambda}{2}\right) \Gamma\left(1 + \frac{\lambda}{2}\right)}{2\Gamma\left(n + 2 + \frac{\lambda}{2}\right) \Gamma\left(\frac{1}{2} - \frac{\lambda}{2}\right)} \quad (\lambda > -2)$$

## 22.13.10

$$\int_{-1}^x \frac{P_n(t) dt}{\sqrt{x-t}} = \frac{1}{(n + \frac{1}{2})\sqrt{1+x}} [T_n(x) + T_{n+1}(x)]$$

## 22.13.11

$$\int_x^1 \frac{P_n(t) dt}{\sqrt{t-x}} = \frac{1}{(n + \frac{1}{2})\sqrt{1-x}} [T_n(x) - T_{n+1}(x)]$$

$$22.13.12 \quad \int_x^\infty e^{-t} L_n^{(\alpha)}(t) dt = e^{-x} [L_n^{(\alpha)}(x) - L_{n-1}^{(\alpha)}(x)]$$

## 22.13.13

$$\Gamma(\alpha + \beta + n + 1) \int_0^x (x-t)^{\beta-1} t^\alpha L_n^{(\alpha)}(t) dt = \Gamma(\alpha + n + 1) \Gamma(\beta) x^{\alpha+\beta} L_n^{(\alpha+\beta)}(x) \quad (\Re\alpha > -1, \Re\beta > 0)$$

## 22.13.14

$$\int_0^x L_m(t) L_n(x-t) dt = \int_0^x L_{m+n}(t) dt = L_{m+n}(x) - L_{m+n+1}(x)$$

$$22.13.15 \quad \int_0^x e^{-t^2} H_n(t) dt = H_{n-1}(0) - e^{-x^2} H_{n-1}(x)$$

$$22.13.16 \quad \int_0^x H_n(t) dt = \frac{1}{2(n+1)} [H_{n+1}(x) - H_{n+1}(0)]$$

$$22.13.17 \quad \int_{-\infty}^\infty e^{-t^2} H_{2m}(tx) dt = \sqrt{\pi} \frac{(2m)!}{m!} (x^2 - 1)^m$$

## 22.13.18

$$\int_{-\infty}^\infty e^{-t^2} t H_{2m+1}(tx) dt = \sqrt{\pi} \frac{(2m+1)!}{m!} x (x^2 - 1)^m$$

$$22.13.19 \quad \int_{-\infty}^\infty e^{-t^2} t^n H_n(xt) dt = \sqrt{\pi} n! P_n(x)$$

## 22.13.20

$$\int_0^\infty e^{-t^2} [H_n(t)]^2 \cos(xt) dt = \sqrt{\pi} 2^{n-1} n! e^{-x^2} L_n\left(\frac{x^2}{2}\right)$$

## 22.14. Inequalities

## 22.14.1

$$|P_n^{(\alpha, \beta)}(x)| \leq \begin{cases} \binom{n+q}{n} \approx n^q, & \text{if } q = \max(\alpha, \beta) \geq -1/2 \\ & (\alpha > -1, \beta > -1) \\ |P_n^{(\alpha, \beta)}(x')| \approx \sqrt{\frac{1}{n}}, & \text{if } q < -\frac{1}{2} \end{cases}$$

$x'$  maximum point nearest to  $\frac{\beta - \alpha}{\alpha + \beta + 1}$

## 22.14.2

$$|C_n^{(\alpha)}(x)| \leq \begin{cases} \binom{n+2\alpha-1}{n} & (\alpha > 0) \\ |C_n^{(\alpha)}(x')| & \left(-\frac{1}{2} < \alpha < 0\right) \end{cases}$$

$x' = 0$  if  $n = 2m$ ;  $x' =$  maximum point nearest zero if  $n = 2m + 1$

## 22.14.3

$$|C_n^{(\alpha)}(\cos \theta)| < 2^{1-\alpha} \frac{n^{\alpha-1}}{(\sin \theta)^\alpha \Gamma(\alpha)} \quad (0 < \alpha < 1, 0 < \theta < \pi)$$

$$22.14.4 \quad |T_n(x)| \leq 1 \quad (-1 \leq x \leq 1)$$

$$22.14.5 \quad \left| \frac{dT_n(x)}{dx} \right| \leq n^2 \quad (-1 \leq x \leq 1)$$

$$22.14.6 \quad |U_n(x)| \leq n + 1 \quad (-1 \leq x \leq 1)$$

$$22.14.7 \quad |P_n(x)| \leq 1 \quad (-1 \leq x \leq 1)$$

$$22.14.8 \quad \left| \frac{dP_n(x)}{dx} \right| \leq \frac{1}{2} n(n+1) \quad (-1 \leq x \leq 1)$$

$$22.14.9 \quad |P_n(x)| \leq \sqrt{\frac{2}{\pi n}} \frac{1}{\sqrt{1-x^2}} \quad (-1 < x \leq 1)^*$$

## 22.14.10

$$P_n^2(x) - P_{n-1}(x)P_{n+1}(x) < \frac{2n+1}{3n(n+1)} \quad (-1 \leq x \leq 1)$$

## 22.14.11

$$P_n^2(x) - P_{n-1}(x)P_{n+1}(x) \geq \frac{1 - P_n^2(x)}{(2n-1)(n+1)} \quad (-1 \leq x \leq 1)$$

$$22.14.12 \quad |L_n(x)| \leq e^{x/2} \quad (x \geq 0)$$

$$22.14.13 \quad |L_n^{(\alpha)}(x)| \leq \frac{\Gamma(\alpha + n + 1)}{n! \Gamma(\alpha + 1)} e^{x/2} \quad (\alpha \geq 0, x \geq 0)$$

## 22.14.14

$$|L_n^{(\alpha)}(x)| \leq \left[ 2 - \frac{\Gamma(\alpha + n + 1)}{n! \Gamma(\alpha + 1)} \right] e^{x/2} \quad (-1 < \alpha < 0, x \geq 0)$$

\*See page 11.

22.14.15  $|H_{2m}(x)| \leq e^{x^2/2} 2^{2m} m! \left[ 2 - \frac{1}{2^{2m}} \binom{2m}{m} \right]$

22.14.16  $|H_{2m+1}(x)| \leq x e^{x^2/2} \frac{(2m+2)!}{(m+1)!} \quad (x \geq 0)$

22.14.17  $|H_n(x)| < e^{x^2/2} k 2^{n/2} \sqrt{n!} \quad k \approx 1.086435$

22.15. Limit Relations

22.15.1

$$\lim_{n \rightarrow \infty} \left[ \frac{1}{n^\alpha} P_n^{(\alpha, \beta)} \left( \cos \frac{x}{n} \right) \right]$$

$$= \lim_{n \rightarrow \infty} \frac{1}{n^\alpha} P_n^{(\alpha, \beta)} \left( 1 - \frac{x^2}{2n^2} \right) = \left( \frac{2}{x} \right)^\alpha J_\alpha(x)$$

22.15.2  $\lim_{n \rightarrow \infty} \left[ \frac{1}{n^\alpha} L_n^{(\alpha)} \left( \frac{x}{n} \right) \right] = x^{-\alpha/2} J_\alpha(2\sqrt{x})$

22.15.3  $\lim_{n \rightarrow \infty} \left[ \frac{(-1)^n \sqrt{n}}{4^n n!} H_{2n} \left( \frac{x}{2\sqrt{n}} \right) \right] = \frac{1}{\sqrt{\pi}} \cos x$

22.15.4  $\lim_{n \rightarrow \infty} \left[ \frac{(-1)^n}{4^n n!} H_{2n+1} \left( \frac{x}{2\sqrt{n}} \right) \right] = \frac{2}{\sqrt{\pi}} \sin x$

22.15.5  $\lim_{\beta \rightarrow \infty} P_n^{(\alpha, \beta)} \left( 1 - \frac{2x}{\beta} \right) = L_n^{(\alpha)}(x)$

22.15.6  $\lim_{\alpha \rightarrow \infty} \frac{1}{\alpha^{n/2}} C_n^{(\alpha)} \left( \frac{x}{\sqrt{\alpha}} \right) = \frac{1}{n!} H_n(x)$

For asymptotic expansions, see [22.5] and [22.17].

22.16. Zeros

For tables of the zeros and associated weight factors necessary for the Gaussian-type quadrature formulas see chapter 25. All the zeros of the orthogonal polynomials are real, simple and located in the interior of the interval of orthogonality.

Explicit and Asymptotic Formulas and Inequalities

Notations:

$x_m^{(n)}$   $m$ th zero of  $f_n(x)$  ( $x_1^{(n)} < x_2^{(n)} < \dots < x_n^{(n)}$ )

$\theta_m^{(n)} = \arccos x_{n-m+1}^{(n)}$  ( $0 < \theta_1^{(n)} < \theta_2^{(n)} < \dots < \theta_n^{(n)} < \pi$ )

$j_{\alpha, m}$ ,  $m$ th positive zero of the Bessel function  $J_\alpha(x)$

$$0 < j_{\alpha, 1} < j_{\alpha, 2} < \dots$$

|         | $f_n(x)$                             | Relation   |
|---------|--------------------------------------|--|
| 22.16.1 | $P_n^{(\alpha, \beta)}(\cos \theta)$ | $\lim_{n \rightarrow \infty} n \theta_m^{(n)} = j_{\alpha, m} \quad (\alpha > -1, \beta > -1)$   |
| 22.16.2 | $C_n^{(\alpha)}(x)$                  | $x_m^{(n)} = 1 - \frac{j_{\alpha-\frac{1}{2}, m}^2}{2n^2} \left[ 1 - \frac{2\alpha}{n} + O\left(\frac{1}{n^2}\right) \right]$  |
| 22.16.3 | $C_n^{(\alpha)}(\cos \theta)$        | $\frac{(m+\alpha-1)\pi}{n+\alpha} \leq \theta_m^{(n)} \leq \frac{m\pi}{n+\alpha} \quad (0 \leq \alpha \leq 1)$   |
| 22.16.4 | $T_n(x)$                             | $x_m^{(n)} = \cos \frac{2m-1}{2n} \pi$   |
| 22.16.5 | $U_n(x)$                             | $x_m^{(n)} = \cos \frac{m}{n+1} \pi$   |
| 22.16.6 | $P_n(\cos \theta)$                   | $\frac{2m-1}{2n+1} \pi \leq \theta_m^{(n)} \leq \frac{2m}{2n+1} \pi$<br>$\theta_m^{(n)} = \frac{4m-1}{4n+2} \pi + \frac{1}{8n^2} \cot \frac{4m-1}{4n+2} \pi + O(n^{-3})$   |
| 22.16.7 | $P_n(x)$                             | $x_m^{(n)} = 1 - \frac{j_{0, m}^2}{2n^2} \left[ 1 - \frac{1}{n} + O(n^{-2}) \right]$<br>$x_m^{(n)} = 1 - \frac{4\xi_m^{(n)}}{2n+1+\xi_m^{(n)}}; \xi_m^{(n)} = \frac{j_{0, m}^2}{4n+2} \left[ 1 + \frac{j_{0, m-2}^2}{12(2n+1)^2} \right] + O\left(\frac{1}{n^5}\right)$  |
| 22.16.8 | $L_n^{(\alpha)}(x)$                  | $\left. \begin{aligned} x_m^{(n)} &> \frac{j_{\alpha, m}^2}{4k_n} \\ x_m^{(n)} &< \frac{k_m}{k_n} (2k_m + \sqrt{4k_m^2 + \frac{1}{4} - \alpha^2}) \\ x_m^{(n)} &= \frac{j_{\alpha, m}^2}{4k_n} \left( 1 + \frac{2(\alpha^2 - 1) + j_{\alpha, m}^2}{48k_n^2} \right) + O(n^{-5}) \end{aligned} \right\} k_r = r + \frac{\alpha+1}{2}$ |

For error estimates see [22.6].

**22.17. Orthogonal Polynomials of a Discrete Variable**

In this section some polynomials  $f_n(x)$  are listed which are orthogonal with respect to the scalar product

22.17.1  $(f_n, f_m) = \sum_i w^*(x_i) f_n(x_i) f_m(x_i).$

The  $x_i$  are the integers in the interval  $a \leq x_i \leq b$  and  $w^*(x_i)$  is a positive function such that

$\sum_i w^*(x_i)$  is finite. The constant factor which is still free in each polynomial when only the orthogonality condition is given is defined here by the explicit representation (which corresponds to the Rodrigues' formula)

22.17.2  $f_n(x) = \frac{1}{r_n w^*(x)} \Delta^n [w^*(x) g(x, n)]$

where  $g(x, n) = g(x)g(x-1) \dots g(x-n+1)$  and  $g(x)$  is a polynomial in  $x$  independent of  $n$ .

| Name       | $a$ | $b$      | $w^*(x)$  | $r_n$                  | $g(x, n)$                                   | Remarks                |
|------------|-----|----------|---|------------------------|---|------------------------|
| Chebyshev  | 0   | $N-1$    | 1   | $1/n!$                 | $\binom{x}{n} \binom{x-N}{n}$               |                        |
| Krawtchouk | 0   | $N$      | $p^x q^{N-x} \binom{N}{x}$  | $(-1)^n n!$            | $\frac{q^x x!}{(x-n)!}$                     | $p, q > 0;$<br>$p+q=1$ |
| Charlier   | 0   | $\infty$ | $\frac{e^{-a} a^x}{x!}$   | $(-1)^n \sqrt{a^n n!}$ | $\frac{x!}{(x-n)!}$                         | $a > 0$                |
| Meixner    | 0   | $\infty$ | $\frac{c^x \Gamma(b+x)}{\Gamma(b)x!}$                                     | $c^n$                  | $\frac{x!}{(x-n)!}$                         | $b > 0, 0 < c < 1$     |
| Hahn       | 0   | $\infty$ | $\frac{\Gamma(b)\Gamma(c+x)\Gamma(d+x)}{x!\Gamma(b+x)\Gamma(c)\Gamma(d)}$ | $n!$                   | $\frac{x!\Gamma(b+x)}{(x-n)!\Gamma(b+x-n)}$ |                        |

For a more complete list of the properties of these polynomials see [22.5] and [22.17].

**Numerical Methods**

**22.18. Use and Extension of the Tables**

*Evaluation of an orthogonal polynomial for which the coefficients are given numerically.*

**Example 1.** Evaluate  $L_6(1.5)$  and its first and second derivative using **Table 22.10** and the Horner scheme.

|         |       |        |           |            |            |   |
|---------|-------|--------|-----------|------------|------------|---|
| 1       | -36   | 450    | -2400     | 5400       | -4320      | 720   |
| $x=1.5$ | 1.5   | -51.75 | 597.375   | -2703.9375 | 4044.09375 | -413.859375   |
| 1       | -34.5 | 398.25 | -1802.625 | 2696.0625  | -275.90625 | 306.140625  |
| 1.5     | 1.5   | -49.5  | 523.125   | -1919.25   | 1165.21875 | $L_6 = \frac{306.140625}{720}$<br>$= .42519\ 53$        |
| 1       | -33.0 | 348.75 | -1279.500 | 776.8125   | 889.3125   |   |
| 1.5     | 1.5   | -47.25 | 452.250   | -1240.875  |            | $L_6' = \frac{889.3125}{720}$<br>$= 1.23515\ 625$       |
| 1       | -31.5 | 301.50 | -827.250  | -464.0625  |            | $L_6'' = 2 \frac{[-464.0625]}{720}$<br>$= -1.28906\ 25$ |

Evaluation of an orthogonal polynomial using the explicit representation when the coefficients are not given numerically.

If an isolated value of the orthogonal polynomial  $f_n(x)$  is to be computed, use the proper explicit expression rewritten in the form

$$f_n(x) = d_n(x)a_0(x)$$

and generate  $a_0(x)$  recursively, where

$$a_{m-1}(x) = 1 - \frac{b_m}{c_m} f(x)a_m(x) \quad (m = n, n-1, \dots, 2, 1, a_n(x) = 1).$$

The  $d_n(x)$ ,  $b_m$ ,  $c_m$ ,  $f(x)$  for the polynomials of this chapter are listed in the following table:

| $f_n(x)$                | $d_n(x)$                                    | $b_m$                       | $c_m$          | $f(x)$ |
|-------------------------|---|-----------------------------|----------------|--------|
| $P_n^{(\alpha, \beta)}$ | $\binom{n+\alpha}{n}$                       | $(n-m+1)(\alpha+\beta+n+m)$ | $2m(\alpha+m)$ | $1-x$  |
| $C_{2n}^{(\alpha)}$     | $(-1)^n \frac{(\alpha)_n}{n!}$              | $2(n-m+1)(\alpha+n+m-1)$    | $m(2m-1)$      | $x^2$  |
| $C_{2n+1}^{(\alpha)}$   | $(-1)^n \frac{(\alpha)_{n+1}}{n!} 2x$       | $2(n-m+1)(\alpha+n+m)$      | $m(2m+1)$      | $x^2$  |
| $T_{2n}$                | $(-1)^n$                                    | $2(n-m+1)(n+m-1)$           | $m(2m-1)$      | $x^2$  |
| $T_{2n+1}$              | $(-1)^n (2n+1)x$                            | $2(n-m+1)(n+m)$             | $m(2m+1)$      | $x^2$  |
| $U_{2n}$                | $(-1)^n$                                    | $2(n-m+1)(n+m)$             | $m(2m-1)$      | $x^2$  |
| $U_{2n+1}$              | $(-1)^n 2(n+1)x$                            | $2(n-m+1)(n+m+1)$           | $m(2m+1)$      | $x^2$  |
| $P_{2n}$                | $\frac{(-1)^n}{4^n} \binom{2n}{n}$          | $(n-m+1)(2n+2m-1)$          | $m(2m-1)$      | $x^2$  |
| $P_{2n+1}$              | $\frac{(-1)^n}{4^n} \binom{2n+1}{n} (n+1)x$ | $(n-m+1)(2n+2m+1)$          | $m(2m+1)$      | $x^2$  |
| $L_n^{(\alpha)}$        | $\binom{n+\alpha}{n}$                       | $n-m+1$                     | $m(\alpha+m)$  | $x$    |
| $H_{2n}$                | $(-1)^n \frac{(2n)!}{n!}$                   | $2(n-m+1)$                  | $m(2m-1)$      | $x^2$  |
| $H_{2n+1}$              | $(-1)^n \frac{(2n+1)!}{n!} 2x$              | $2(n-m+1)$                  | $m(2m+1)$      | $x^2$  |

**Example 2.** Compute  $P_8^{(1/2, 3/2)}(2)$ . Here  $d_8 = \binom{8.5}{8} = 3.33847$ ,  $f(2) = -1$ .

| $m$   | 8   | 7        | 6        | 5        | 4        | 3        | 2        | 1        | 0        |
|-------|-----|----------|----------|----------|----------|----------|----------|----------|----------|
| $a_m$ | 1   | 1.132353 | 1.366667 | 1.841026 | 3.008392 | 6.849651 | 26.44156 | 223.1091 | 6545.533 |
| $b_m$ | 18  | 34       | 48       | 60       | 70       | 78       | 84       | 88       | 90       |
| $c_m$ | 136 | 105      | 78       | 55       | 36       | 21       | 10       | 3        | 0        |

$$P_8^{(1/2, 3/2)}(2) = d_8 a_0(2) = (3.33847)(6545.533) = 21852.07$$

Evaluation of orthogonal polynomials by means of their recurrence relations

**Example 3.** Compute  $C_n^{(1/2)}(2.5)$  for  $n = 2, 3, 4, 5, 6$ .

From **Table 22.2**  $C_0^{(1/2)} = 1$ ,  $C_1^{(1/2)} = 1.25$  and from **22.7** the recurrence relation is

$$C_{n+1}^{(1/2)}(2.5) = [5(n + \frac{1}{2})C_n^{(1/2)}(2.5) - (n - \frac{1}{2})C_{n-1}^{(1/2)}(2.5)] \frac{1}{n+1}.$$

| $n$                | 2       | 3        | 4        | 5        | 6        |
|--------------------|---------|----------|----------|----------|----------|
| $C_n^{(1/2)}(2.5)$ | 3.65625 | 13.08594 | 50.87648 | 207.0649 | 867.7516 |

Check: Compute  $C_6^{(1/2)}(2.5)$  by the method of **Example 2**.

**Change of Interval of Orthogonality**

In some applications it is more convenient to use polynomials orthogonal on the interval  $[0, 1]$ . One can obtain the new polynomials from the ones given in this chapter by the substitution  $x=2\bar{x}-1$ . The coefficients of the new polynomial can be computed from the old by the following recursive scheme, provided the standardization is not changed. If

$$f_n(x) = \sum_{m=0}^n a_m x^m, \quad f_n^*(x) = f_n(2x-1) = \sum_{m=0}^n a_m^* x^m$$

then the  $a_m^*$  are given recursively by the  $a_m$  through the relations

$$a_m^{(j)} = 2a_m^{(j-1)} - a_{m+1}^{(j)}; \quad m = n-1, n-2, \dots, j; \quad j = 0, 1, 2, \dots, n$$

$$a_m^{(-1)} = a_m/2, \quad m = 0, 1, 2, \dots, n$$

$$a_n^{(j)} = 2^j a_n, \quad j = 0, 1, 2, \dots, n \text{ and } a_m^{(m)} = a_m^*; \quad m = 0, 1, 2, \dots, n.$$

**Example 4.** Given  $T_5(x) = 5x - 20x^3 + 16x^5$ , find  $T_5^*(x)$ .

|                  |                  |                 |                    |                |                    |              |
|------------------|------------------|-----------------|--------------------|----------------|--------------------|--------------|
| $m \backslash j$ | 5                | 4               | 3                  | 2              | 1                  | 0            |
| -1               | $8 = a_5^{(-1)}$ | 0               | $-10 = a_3^{(-1)}$ | 0              | $2.5 = a_1^{(-1)}$ | 0            |
| 0                | 16               | -16             | -4                 | 4              | 1                  | $-1 = a_0^*$ |
| 1                | 32               | -64             | 56                 | -48            | $50 = a_1^*$       |              |
| 2                | 64               | -192            | 304                | $-400 = a_2^*$ |                    |              |
| 3                | 128              | -512            | $1120 = a_3^*$     |                |                    |              |
| 4                | 256              | $-1280 = a_4^*$ |                    |                |                    |              |
| 5                | $512 = a_5^*$    |                 |                    |                |                    |              |

Hence,  $T_5^*(x) = 512x^5 - 1280x^4 + 1120x^3 - 400x^2 + 50x - 1$ .

**22.19. Least Square Approximations**

*Problem:* Given a function  $f(x)$  (analytically or in form of a table) in a domain  $D$  (which may be a continuous interval or a set of discrete points).<sup>2</sup> Approximate  $f(x)$  by a polynomial  $F_n(x)$  of given degree  $n$  such that a weighted sum of the squares of the errors in  $D$  is least.

*Solution:* Let  $w(x) \geq 0$  be the weight function chosen according to the relative importance of the errors in different parts of  $D$ . Let  $f_m(x)$  be orthogonal polynomials in  $D$  relative to  $w(x)$ , i.e.  $(f_m, f_n) = 0$  for  $m \neq n$ , where

$$(f, g) = \begin{cases} \int_D w(x)f(x)g(x)dx & \text{if } D \text{ is a continuous interval} \\ \sum_{m=1}^N w(x_m)f(x_m)g(x_m) & \text{if } D \text{ is a set of } N \text{ discrete points } x_m. \end{cases}$$

Then

$$F_n(x) = \sum_{m=0}^n a_m f_m(x)$$

where

$$* \quad a_m = (f, f_m) / (f_m, f_m).$$

<sup>2</sup>  $f(x)$  has to be square integrable, see e.g. [22.17].

\*See page II.

**D a Continuous Interval**

**Example 5.** Find a least square polynomial of degree 5 for  $f(x) = \frac{1}{1+x}$ , in the interval  $2 \leq x \leq 5$ , using the weight function

$$w(x) = \frac{1}{\sqrt{(x-2)(5-x)}}$$

which stresses the importance of the errors at the ends of the interval.

Reduction to interval  $[-1, 1]$ ,  $t = \frac{2x-7}{3}$

$$w(x(t)) = \frac{2}{3} \frac{1}{\sqrt{1-t^2}}$$

From 22.2,  $f_m(t) = T_m(t)$  and

$$a_m = \frac{4}{3\pi} \int_{-1}^1 \frac{1}{\sqrt{1-t^2}} \frac{1}{t+3} T_m(t) dt \quad (m \neq 0)$$

$$a_0 = \frac{2}{3\pi} \int_{-1}^1 \frac{1}{\sqrt{1-t^2}} \frac{dt}{t+3}$$

**Example 7.** Economize  $f(x) = 1 + x/2 + x^2/3 + x^3/4 + x^4/5 + x^5/6$  with  $R = .05$ .

From Table 22.3

$$f(x) = \frac{1}{120} [149T_0(x) + 32T_2(x) + 3T_4(x)] \\ + \frac{1}{96} [76T_1(x) + 11T_3(x) + T_5(x)]$$

so

$$\bar{f}(x) = \frac{1}{120} [149T_0(x) + 32T_2(x)] + \frac{1}{96} [76T_1(x) + 11T_3(x)]$$

since

$$|\bar{f}(x) - f(x)| \leq \frac{1}{40} + \frac{1}{96} < .05$$

## References

### Texts

- [22.1] Bibliography on orthogonal polynomials, Bull. of the National Research Council No. 103, Washington, D.C. (1940).
- [22.2] P. L. Chebyshev, Sur l'interpolation. Oeuvres, vol. 2, pp. 59-68.
- [22.3] R. Courant and D. Hilbert, Methods of mathematical physics, vol. 1, ch. 7 (Interscience Publishers, New York, N.Y., 1953).
- [22.4] G. Doetsch, Die in der Statistik seltener Ereignisse auftretenden Charlierschen Polynome und eine damit zusammenhängende Differential-differenzgleichung, Math. Ann. 109, 257-266 (1934).
- [22.5] A. Erdélyi et al., Higher transcendental functions, vol. 2, ch. 10 (McGraw-Hill Book Co., Inc., New York, N.Y., 1953).
- [22.6] L. Gatteschi, Limitazione degli errori nelle formule asintotiche per le funzioni speciali, Rend. Sem. Mat. Univ. Torina 16, 83-94 (1956-57).
- [22.7] T. L. Geronimus, Teoria ortogonalnikh mnogochlenov (Moscow, U.S.S.R., 1950).
- [22.8] W. Hahn, Über Orthogonalpolynome, die q-Differenzgleichungen genügen, Math. Nachr. 2, 4-34 (1949).
- [22.9] St. Kaczmarz and H. Steinhaus, Theorie der Orthogonalreihen, ch. 4 (Chelsea Publishing Co., New York, N.Y., 1951).
- [22.10] M. Krawtchouk, Sur une généralisation des polynomes d'Hermite, C.R. Acad. Sci. Paris 187, 620-622 (1929).
- [22.11] C. Lanczos, Trigonometric interpolation of empirical and analytical functions, J. Math. Phys. 17, 123-199 (1938).
- [22.12] C. Lanczos, Applied analysis (Prentice-Hall, Inc., Englewood Cliffs, N.J., 1956).
- [22.13] W. Magnus and F. Oberhettinger, Formeln und Sätze für die speziellen Funktionen der mathematischen Physik, ch. 5, 2d ed. (Springer-Verlag, Berlin, Germany, 1948).
- [22.14] J. Meixner, Orthogonale Polynomsysteme mit einer besonderen Gestalt der erzeugenden Funktion, J. London Math. Soc. 9, 6-13 (1934).
- [22.15] G. Sansone, Orthogonal functions, Pure and Applied Mathematics, vol. IX (Interscience Publishers, New York, N.Y., 1959).
- [22.16] J. Shohat, Théorie générale des polynomes orthogonaux de Tehebichef, Mém. Soc. Math. 66 (Gauthier-Villars, Paris, France, 1934).
- [22.17] G. Szegő, Orthogonal polynomials, Amer. Math. Soc. Colloquium Publications 23, rev. ed. (1959).
- [22.18] F. G. Tricomi, Vorlesungen über Orthogonalreihen, chs. 4, 5, 6 (Springer-Verlag, Berlin, Germany, 1955).

### Tables

- [22.19] British Association for the Advancement of Science, Legendre Polynomials, Mathematical Tables, Part vol. A (Cambridge Univ. Press, Cambridge, England, 1946).  $P_n(x)$ ,  $x=0(.01)6$ ,  $n=1(1)12$ , 7-8D.
- [22.20] N. R. Jörgensen, Undersøgelser over frekvensflader og korrelation (Busck, Copenhagen, Denmark, 1916).  $He_n(x)$ ,  $x=0(.01)4$ ,  $n=1(1)6$ , exact.
- [22.21] L. N. Karmazina, Tablitsy polinomov Jacobi (Izdat. Akad. Nauk SSSR., Moscow, U.S.S.R., 1954).  $G_n(p, q, x)$ ,  $x=0(.01)1$ ,  $q=.1(1)1$ ,  $p=1.1(1)3$ ,  $n=1(1)5$ , 7D.
- [22.22] National Bureau of Standards, Tables of Chebyshev polynomials  $S_n(x)$  and  $C_n(x)$ , Applied Math. Series 9 (U.S. Government Printing Office, Washington, D.C., 1952).  $x=0(.001)2$ ,  $n=2(1)12$ , 12D; Coefficients for  $T_n(x)$ ,  $U_n(x)$ ,  $C_n(x)$ ,  $S_n(x)$  for  $n=0(1)12$ .
- [22.23] J. B. Russel, A table of Hermite functions, J. Math. Phys. 12, 291-297 (1933).  $e^{-x^2/2}H_n(x)$ ,  $x=0(.04)1(1)4(.2)7(.5)8$ ,  $n=0(1)11$ , 5D.
- [22.24] N. Wiener, Extrapolation, interpolation and smoothing of stationary time series (John Wiley & Sons, Inc., New York, N.Y., 1949).  $L_n(x)$ ,  $n=0(1)5$ ,  $x=0(.01).1(1)18(.2)20(.5)21(1)26(2)30$ , 3-5D.

# 23. Bernoulli and Euler Polynomials— Riemann Zeta Function

EMILIE V. HAYNSWORTH<sup>1</sup> AND KARL GOLDBERG<sup>2</sup>

## Contents

|   | Page |
|---|------|
| <b>Mathematical Properties</b> . . . . .  | 804  |
| 23.1. Bernoulli and Euler Polynomials and the Euler-Maclaurin<br>Formula . . . . .                                      | 804  |
| 23.2. Riemann Zeta Function and Other Sums of Reciprocal<br>Powers . . . . .  | 807  |
| <b>References</b> . . . . .   | 808  |
| <b>Table 23.1.</b> Coefficients of the Bernoulli and Euler Polynomials . . .<br>$B_n(x)$ and $E_n(x)$ , $n=0(1)15$      | 809  |
| <b>Table 23.2.</b> Bernoulli and Euler Numbers . . . . .<br>$B_n$ and $E_n$ , $n=0, 1, 2(2)60$ , Exact and $B_n$ to 10S | 810  |
| <b>Table 23.3.</b> Sums of Reciprocal Powers . . . . .  | 811  |

$$\zeta(n) = \sum_{k=1}^{\infty} \frac{1}{k^n}, \quad 20D$$

$$\eta(n) = \sum_{k=1}^{\infty} \frac{(-1)^{k-1}}{k^n}, \quad 20D$$

$$\lambda(n) = \sum_{k=0}^{\infty} \frac{1}{(2k+1)^n}, \quad 20D$$

$$\beta(n) = \sum_{k=0}^{\infty} \frac{(-1)^k}{(2k+1)^n}, \quad 18D$$

$$n=1(1)42$$

|  |     |
|--|-----|
| <b>Table 23.4.</b> Sums of Positive Powers . . . . . | 813 |
|--|-----|

$$\sum_{k=1}^m k^n, \quad n=1(1)10, \quad m=1(1)100$$

|  |     |
|--|-----|
| <b>Table 23.5.</b> $x^n/n!$ , $x=2(1)9$ , $n=1(1)50$ , 10S . . . . . | 818 |
|--|-----|

The authors acknowledge the assistance of Ruth E. Capuano in the preparation and checking of the tables.

<sup>1</sup>National Bureau of Standards. (Presently, Auburn University.)

<sup>2</sup>National Bureau of Standards.



# 23. Bernoulli and Euler Polynomials—Riemann Zeta Function

## Mathematical Properties

### 23.1. Bernoulli and Euler Polynomials and the Euler-Maclaurin Formula

#### Generating Functions

$$23.1.1 \quad \frac{te^{zt}}{e^t-1} = \sum_{n=0}^{\infty} B_n(x) \frac{t^n}{n!} \quad |t| < 2\pi \quad \left| \quad \frac{2e^{zt}}{e^t+1} = \sum_{n=0}^{\infty} E_n(x) \frac{t^n}{n!} \quad |t| < \pi \right.$$

#### Bernoulli and Euler Numbers

$$23.1.2 \quad B_n = B_n(0) \quad n=0, 1, \dots \quad \left| \quad E_n = 2^n E_n\left(\frac{1}{2}\right) = \text{integer} \quad n=0, 1, \dots \right.$$

$$23.1.3 \quad B_0=1, B_1=-\frac{1}{2}, B_2=\frac{1}{6}, B_4=-\frac{1}{30} \quad \left| \quad E_0=1, E_2=-1, E_4=5 \right.$$

(For occurrence of  $B_n$  and  $E_n$  in series expansions of circular functions, see chapter 4.)

#### Sums of Powers

$$23.1.4 \quad \sum_{k=1}^m k^n = \frac{B_{n+1}(m+1) - B_{n+1}}{n+1} \quad m, n=1, 2, \dots \quad \left| \quad \sum_{k=1}^m (-1)^{m-k} k^n = \frac{E_n(m+1) + (-1)^m E_n(0)}{2} \quad m, n=1, 2, \dots \right.$$

#### Derivatives and Differences

$$23.1.5 \quad B'_n(x) = nB_{n-1}(x) \quad n=1, 2, \dots \quad \left| \quad E'_n(x) = nE_{n-1}(x) \quad n=1, 2, \dots \right.$$

$$23.1.6 \quad B_n(x+1) - B_n(x) = nx^{n-1} \quad n=0, 1, \dots \quad \left| \quad E_n(x+1) + E_n(x) = 2x^n \quad n=0, 1, \dots \right.$$

#### Expansions

$$23.1.7 \quad B_n(x+h) = \sum_{k=0}^n \binom{n}{k} B_k(x) h^{n-k} \quad n=0, 1, \dots \quad \left| \quad E_n(x+h) = \sum_{k=0}^n \binom{n}{k} E_k(x) h^{n-k} \quad n=0, 1, \dots \right.$$

$$E_n(x) = \sum_{k=0}^n \binom{n}{k} \frac{E_k}{2^k} \left(x - \frac{1}{2}\right)^{n-k} \quad n=0, 1, \dots$$

#### Symmetry

$$23.1.8 \quad B_n(1-x) = (-1)^n B_n(x) \quad n=0, 1, \dots \quad \left| \quad E_n(1-x) = (-1)^n E_n(x) \quad n=0, 1, \dots \right.$$

$$23.1.9 \quad (-1)^n B_n(-x) = B_n(x) + nx^{n-1} \quad n=0, 1, \dots \quad \left| \quad (-1)^{n+1} E_n(-x) = E_n(x) - 2x^n \quad n=0, 1, \dots \right.$$

#### Multiplication Theorem

$$23.1.10 \quad B_n(mx) = m^{n-1} \sum_{k=0}^{m-1} B_n\left(x + \frac{k}{m}\right) \quad n=0, 1, \dots \quad \left| \quad E_n(mx) = m^n \sum_{k=0}^{m-1} (-1)^k E_n\left(x + \frac{k}{m}\right) \quad n=0, 1, \dots \right.$$

$$m=1, 2, \dots \quad \left| \quad E_n(mx) = -\frac{2}{n+1} m^n \sum_{k=0}^{m-1} (-1)^k B_{n+1}\left(x + \frac{k}{m}\right) \quad m=1, 3, \dots \right.$$

$$n=0, 1, \dots$$

$$m=2, 4, \dots$$

**Integrals**

|   |  |
|---|--|
| <p><b>23.1.11</b> <math>\int_a^x B_n(t)dt = \frac{B_{n+1}(x) - B_{n+1}(a)}{n+1}</math></p> <p><b>23.1.12</b> <math>\int_0^1 B_n(t)B_m(t)dt = (-1)^{n-1} \frac{m!n!}{(m+n)!} B_{m+n}</math><br/> <math>m, n = 1, 2, \dots</math></p> | <p><math>\int_a^x E_n(t)dt = \frac{E_{n+1}(x) - E_{n+1}(a)}{n+1}</math></p> <p><math>\int_0^1 E_n(t)E_m(t)dt = (-1)^n 4(2^{m+n+2}-1) \frac{m!n!}{(m+n+2)!} B_{m+n+2}</math><br/> <math>m, n = 0, 1, \dots</math></p> |
|---|--|

(The polynomials are orthogonal for  $m+n$  odd.)

**Inequalities**

|   |  |
|---|--|
| <p><b>23.1.13</b> <math> B_{2n}  &gt;  B_{2n}(x)  \quad n=1, 2, \dots, \quad 1 &gt; x &gt; 0</math></p> <p><b>23.1.14</b><br/> <math>\frac{2(2n+1)!}{(2\pi)^{2n+1}} \left( \frac{1}{1-2^{-2n}} \right) &gt; (-1)^{n+1} B_{2n+1}(x) &gt; 0</math><br/> <math>n=1, 2, \dots, \quad \frac{1}{2} &gt; x &gt; 0</math></p> <p><b>23.1.15</b><br/> <math>\frac{2(2n)!}{(2\pi)^{2n}} \left( \frac{1}{1-2^{1-2n}} \right) &gt; (-1)^{n+1} B_{2n} &gt; \frac{2(2n)!}{(2\pi)^{2n}}</math><br/> <math>n=1, 2, \dots</math></p> | <p><math>4^{-n}  E_{2n}  &gt; (-1)^n E_{2n}(x) &gt; 0 \quad n=1, 2, \dots, \quad \frac{1}{2} &gt; x &gt; 0</math></p> <p><math>\frac{4(2n-1)!}{\pi^{2n}} \left( 1 + \frac{1}{2^{2n-2}} \right) &gt; (-1)^n E_{2n-1}(x) &gt; 0</math><br/> <math>n=1, 2, \dots, \quad \frac{1}{2} &gt; x &gt; 0</math></p> <p><math>\frac{4^{n+1}(2n)!}{\pi^{2n+1}} &gt; (-1)^n E_{2n} &gt; \frac{4^{n+1}(2n)!}{\pi^{2n+1}} \left( \frac{1}{1+3^{-1-2n}} \right)</math><br/> <math>n=0, 1, \dots</math></p> |
|---|--|

**Fourier Expansions**

|   |  |
|---|--|
| <p><b>23.1.16</b><br/> <math>B_n(x) = -2 \frac{n!}{(2\pi)^n} \sum_{k=1}^{\infty} \frac{\cos(2\pi kx - \frac{1}{2}\pi n)}{k^n}</math><br/> <math>n &gt; 1, 1 \geq x \geq 0</math><br/> <math>n=1, 1 &gt; x &gt; 0</math></p> <p><b>23.1.17</b><br/> <math>B_{2n-1}(x) = \frac{(-1)^n 2(2n-1)!}{(2\pi)^{2n-1}} \sum_{k=1}^{\infty} \frac{\sin 2k\pi x}{k^{2n-1}}</math><br/> <math>n &gt; 1, 1 \geq x \geq 0</math><br/> <math>n=1, 1 &gt; x &gt; 0</math></p> <p><b>23.1.18</b><br/> <math>B_{2n}(x) = \frac{(-1)^{n-1} 2(2n)!}{(2\pi)^{2n}} \sum_{k=1}^{\infty} \frac{\cos 2k\pi x}{k^{2n}}</math><br/> <math>n=1, 2, \dots, \quad 1 \geq x \geq 0</math></p> | <p><math>E_n(x) = 4 \frac{n!}{\pi^{n+1}} \sum_{k=0}^{\infty} \frac{\sin((2k+1)\pi x - \frac{1}{2}\pi n)}{(2k+1)^{n+1}}</math><br/> <math>n &gt; 0, 1 \geq x \geq 0</math><br/> <math>n=0, 1 &gt; x &gt; 0</math></p> <p><math>E_{2n-1}(x) = \frac{(-1)^n 4(2n-1)!}{\pi^{2n}} \sum_{k=0}^{\infty} \frac{\cos(2k+1)\pi x}{(2k+1)^{2n}}</math><br/> <math>n=1, 2, \dots, \quad 1 \geq x \geq 0</math></p> <p><math>E_{2n}(x) = \frac{(-1)^n 4(2n)!}{\pi^{2n+1}} \sum_{k=0}^{\infty} \frac{\sin(2k+1)\pi x}{(2k+1)^{2n+1}}</math><br/> <math>n &gt; 0, 1 \geq x \geq 0</math><br/> <math>n=0, 1 &gt; x &gt; 0</math></p> |
|---|--|

**Special Values**

|   |   |
|---|---|
| <p><b>23.1.19</b> <math>B_{2n+1} = 0 \quad n=1, 2, \dots</math></p> <p><b>23.1.20</b> <math>B_n(0) = (-1)^n B_n(1)</math><br/> <math>= B_n \quad n=0, 1, \dots</math></p> <p><b>23.1.21</b> <math>B_n(\frac{1}{2}) = -(1-2^{1-n})B_n \quad n=0, 1, \dots</math></p> | <p><math>E_{2n+1} = 0 \quad n=0, 1, \dots</math></p> <p><math>E_n(0) = -E_n(1)</math><br/> <math>= -2(n+1)^{-1}(2^{n+1}-1)B_{n+1} \quad n=1, 2, \dots</math></p> <p><math>E_n(\frac{1}{2}) = 2^{-n}E_n \quad n=0, 1, \dots</math></p> |
|---|---|

$$23.1.22 \quad B_n\left(\frac{1}{4}\right) = (-1)^n B_n\left(\frac{3}{4}\right) \\ = -2^{-n}(1-2^{1-n})B_n - n4^{-n}E_{n-1} \\ n=1, 2, \dots$$

$$E_{2n-1}\left(\frac{1}{3}\right) = -E_{2n-1}\left(\frac{2}{3}\right) \\ = -(2n)^{-1}(1-3^{1-2n})(2^{2n}-1)B_{2n} \\ n=1, 2, \dots$$

$$23.1.23 \quad B_{2n}\left(\frac{1}{3}\right) = B_{2n}\left(\frac{2}{3}\right) \\ = -2^{-1}(1-3^{1-2n})B_{2n} \quad n=0, 1, \dots$$

$$23.1.24 \quad B_{2n}\left(\frac{1}{6}\right) = B_{2n}\left(\frac{5}{6}\right) \\ = 2^{-1}(1-2^{1-2n})(1-3^{1-2n})B_{2n} \\ n=0, 1, \dots$$

## Symbolic Operations

$$23.1.25 \quad p(B(x)+1) - p(B(x)) = p'(x)$$

$$p(E(x)+1) + p(E(x)) = 2p(x)$$

$$23.1.26 \quad B_n(x+h) = (B(x)+h)^n \quad n=0, 1, \dots \quad E_n(x+h) = (E(x)+h)^n \quad n=0, 1, \dots$$

Here  $p(x)$  denotes a polynomial in  $x$  and after expanding we set  $\{B(x)\}^n = B_n(x)$  and  $\{E(x)\}^n = E_n(x)$ .

## Relations Between the Polynomials

23.1.27

$$E_{n-1}(x) = \frac{2^n}{n} \left\{ B_n\left(\frac{x+1}{2}\right) - B_n\left(\frac{x}{2}\right) \right\} \\ = \frac{2}{n} \left\{ B_n(x) - 2^n B_n\left(\frac{x}{2}\right) \right\} \quad n=1, 2, \dots$$

23.1.28

$$E_{n-2}(x) = 2 \binom{n}{2}^{-1} \sum_{k=0}^{n-2} \binom{n}{k} (2^{n-k}-1) B_{n-k} B_k(x) \\ n=2, 3, \dots$$

23.1.29

$$B_n(x) = 2^{-n} \sum_{k=0}^n \binom{n}{k} B_{n-k} E_k(2x) \quad n=0, 1, \dots$$

## Euler-Maclaurin Formulas

Let  $F(x)$  have its first  $2n$  derivatives continuous on an interval  $(a, b)$ . Divide the interval into  $m$  equal parts and let  $h=(b-a)/m$ . Then for some  $\theta, 1 > \theta > 0$ , depending on  $F^{(2n)}(x)$  on  $(a, b)$ , we have

23.1.30

$$\sum_{k=0}^m F(a+kh) = \frac{1}{h} \int_a^b F(t) dt + \frac{1}{2} \{F(b) + F(a)\} \\ + \sum_{k=1}^{n-1} \frac{h^{2k-1}}{(2k)!} B_{2k} \{F^{(2k-1)}(b) - F^{(2k-1)}(a)\} \\ + \frac{h^{2n}}{(2n)!} B_{2n} \sum_{k=0}^{m-1} F^{(2n)}(a+kh+\theta h)$$

Equivalent to this is

23.1.31

$$\frac{1}{h} \int_x^{x+h} F(t) dt = \frac{1}{2} \{F(x+h) + F(x)\} \\ - \sum_{k=1}^{n-1} \frac{h^{2k-1}}{(2k)!} B_{2k} \{F^{(2k-1)}(x+h) - F^{(2k-1)}(x)\} \\ - \frac{h^{2n}}{(2n)!} B_{2n} F^{(2n)}(x+\theta h) \quad b-h \geq x \geq a$$

Let  $\hat{B}_n(x) = B_n(x - [x])$ . The Euler Summation Formula is

23.1.32

$$\sum_{k=0}^{m-1} F(a+kh+\omega h) = \frac{1}{h} \int_a^b F(t) dt \\ + \sum_{k=1}^p \frac{h^{k-1}}{k!} B_k(\omega) \{F^{(k-1)}(b) - F^{(k-1)}(a)\} \\ - \frac{h^p}{p!} \int_0^1 \hat{B}_p(\omega-t) \left\{ \sum_{k=0}^{m-1} F^{(p)}(a+kh+th) \right\} dt \\ p \leq 2n, 1 \geq \omega \geq 0$$

**23.2. Riemann Zeta Function and Other Sums of Reciprocal Powers**

23.2.1  $\zeta(s) = \sum_{k=1}^{\infty} k^{-s}$   $\Re s > 1$

23.2.2  $= \prod_p (1 - p^{-s})^{-1}$   $\Re s > 1$

(product over all primes  $p$ ).

23.2.3 
$$= \frac{1}{s-1} + \frac{1}{2} + \sum_{k=1}^n \frac{B_{2k}}{2k} \left( \frac{s+2k-2}{2k-1} \right) - \frac{(s+2n)}{(2n+1)} \int_1^{\infty} \frac{B_{2n+1}(x-[x])}{x^{s+2n+1}} dx$$
  $s \neq 1, n=1, 2, \dots, \Re s > -2n$

\* 23.2.4 
$$= -\frac{\Gamma(1-s)}{2\pi i} \int_C \frac{(-z)^{s-1}}{e^z - 1} dz$$

23.2.5 
$$= \frac{1}{s-1} + \sum_{n=0}^{\infty} \frac{(-1)^n}{n!} \gamma_n (s-1)^n$$

where

$$\gamma_n = \lim_{m \rightarrow \infty} \left\{ \sum_{k=1}^m \frac{(\ln k)^n}{k} - \frac{(\ln m)^{n+1}}{n+1} \right\}$$
  $\Re s > 0$

23.2.6 
$$= 2^s \pi^{s-1} \sin(\frac{1}{2}\pi s) \Gamma(1-s) \zeta(1-s)$$

23.2.7 
$$= \frac{1}{\Gamma(s)} \int_0^{\infty} \frac{x^{s-1}}{e^x - 1} dx$$
  $\Re s > 1$

23.2.8 
$$= \frac{1}{(1-2^{1-s})\Gamma(s)} \int_0^{\infty} \frac{x^{s-1}}{e^x + 1} dx$$

23.2.9 
$$= \sum_{k=1}^n k^{-s} + (s-1)^{-1} n^{1-s} - s \int_n^{\infty} \frac{x-[x]}{x^{s+1}} dx$$
  $n=1, 2, \dots, \Re s > 0$

23.2.10 
$$= \frac{\exp(\ln 2\pi - 1 - \frac{1}{2}\gamma)s}{2(s-1)\Gamma(\frac{1}{2}s+1)} \prod_{\rho} \left( 1 - \frac{s}{\rho} \right) e^{\frac{s}{\rho}}$$

product over all zeros  $\rho$  of  $\zeta(s)$  with  $\Re \rho > 0$ .

The contour  $C$  in the fourth formula starts at infinity on the positive real axis, circles the origin once in the positive direction excluding the points  $\pm 2ni\pi$  for  $n=1, 2, \dots$ , and returns to the starting point. Therefore  $\zeta(s)$  is regular for all values of  $s$  except for a simple pole at  $s=1$  with residue 1.

**Special Values**

23.2.11  $\zeta(0) = -\frac{1}{2}$

23.2.12  $\zeta(1) = \infty$

23.2.13  $\zeta'(0) = -\frac{1}{2} \ln 2\pi$

23.2.14  $\zeta(-2n) = 0$   $n=1, 2, \dots$

23.2.15  $\zeta(1-2n) = -\frac{B_{2n}}{2n}$   $n=1, 2, \dots$

23.2.16  $\zeta(2n) = \frac{(2\pi)^{2n}}{2(2n)!} |B_{2n}|$   $n=1, 2, \dots$

**23.2.17**

$$\zeta(2n+1) = \frac{(-1)^{n+1} (2\pi)^{2n+1}}{2(2n+1)!} \int_0^1 B_{2n+1}(x) \cot(\pi x) dx$$
  $n=1, 2, \dots$

**Sums of Reciprocal Powers**

The sums referred to are

23.2.18  $\zeta(n) = \sum_{k=1}^{\infty} k^{-n}$   $n=2, 3, \dots$

**23.2.19**

$$\eta(n) = \sum_{k=1}^{\infty} (-1)^{k-1} k^{-n} = (1-2^{1-n})\zeta(n)$$
  $n=1, 2, \dots$

**23.2.20**

$$\lambda(n) = \sum_{k=0}^{\infty} (2k+1)^{-n} = (1-2^{-n})\zeta(n)$$
  $n=2, 3, \dots$

**23.2.21**

$$\beta(n) = \sum_{k=0}^{\infty} (-1)^k (2k+1)^{-n}$$
  $n=1, 2, \dots$

These sums can be calculated from the Bernoulli and Euler polynomials by means of the last two formulas for special values of the zeta function (note that  $\eta(1) = \ln 2$ ), and

23.2.22 
$$\beta(2n+1) = \frac{(\pi/2)^{2n+1}}{2(2n)!} |E_{2n}|$$
  $n=0, 1, \dots$

**23.2.23**

$$\beta(2n) = \frac{(-1)^n \pi^{2n}}{4(2n-1)!} \int_0^1 E_{2n-1}(x) \sec(\pi x) dx$$
  $n=1, 2, \dots$

$\beta(2)$  is known as Catalan's constant. Some other special values are

23.2.24  $\zeta(2) = 1 + \frac{1}{2^2} + \frac{1}{3^2} + \dots = \frac{\pi^2}{6}$

23.2.25  $\zeta(4) = 1 + \frac{1}{2^4} + \frac{1}{3^4} + \dots = \frac{\pi^4}{90}$

\* See page 11.

$$23.2.26 \quad \eta(2) = 1 - \frac{1}{2^2} + \frac{1}{3^2} - \dots = \frac{\pi^2}{12}$$

$$23.2.27 \quad \eta(4) = 1 - \frac{1}{2^4} + \frac{1}{3^4} - \dots = \frac{7\pi^4}{720}$$

$$23.2.28 \quad \lambda(2) = 1 + \frac{1}{3^2} + \frac{1}{5^2} + \dots = \frac{\pi^2}{8}$$

$$23.2.29 \quad \lambda(4) = 1 + \frac{1}{3^4} + \frac{1}{5^4} + \dots = \frac{\pi^4}{96}$$

$$23.2.30 \quad \beta(1) = 1 - \frac{1}{3} + \frac{1}{5} - \dots = \frac{\pi}{4}$$

$$23.2.31 \quad \beta(3) = 1 - \frac{1}{3^3} + \frac{1}{5^3} - \dots = \frac{\pi^3}{32}$$

## References

### Texts

- [23.1] G. Boole, *The calculus of finite differences*, 3d ed. (Hafner Publishing Co., New York, N.Y., 1932).
- [23.2] W. E. Briggs and S. Chowla, *The power series coefficients of  $\zeta(s)$* , *Amer. Math. Monthly* **62**, 323–325 (1955).
- [23.3] T. Fort, *Finite differences* (Clarendon Press, Oxford, England, 1948).
- [23.4] C. Jordan, *Calculus of finite differences*, 2d ed. (Chelsea Publishing Co., New York, N.Y., 1960).
- [23.5] K. Knopp, *Theory and application of infinite series* (Blackie and Son, Ltd., London, England, 1951).
- [23.6] L. M. Milne-Thomson, *Calculus of finite differences* (Macmillan and Co., Ltd., London, England, 1951).
- [23.7] N. E. Nörlund, *Vorlesungen über Differenzenrechnung* (Edwards Bros., Ann Arbor, Mich., 1945).
- [23.8] C. H. Richardson, *An introduction to the calculus of finite differences* (D. Van Nostrand Co., Inc., New York, N.Y., 1954).
- [23.9] J. F. Steffensen, *Interpolation* (Chelsea Publishing Co., New York, N.Y., 1950).
- [23.10] E. C. Titchmarsh, *The zeta-function of Riemann* (Cambridge Univ. Press, Cambridge, England, 1930).
- [23.11] A. D. Wheelon, *A short table of summable series*, Report No. SM-14642, Douglas Aircraft Co., Inc., Santa Monica, Calif. (1953).

### Tables

- [23.12] G. Blanch and R. Siegel, *Table of modified Bernoulli polynomials*, *J. Research NBS* **44**, 103–107 (1950) RP2060.
- [23.13] H. T. Davis, *Tables of the higher mathematical functions*, vol. II (Principia Press, Bloomington, Ind., 1935).
- [23.14] R. Hensman, *Tables of the generalized Riemann Zeta function*, Report No. T2111, Telecommunications Research Establishment, Ministry of Supply, Great Malvern, Worcestershire, England (1948).  $\zeta(s, a)$ ,  $s = -10(.1)0$ ,  $a = 0(.1)2$ , 5D;  $(s-1)\zeta(s, a)$ ,  $s = 0(.1)1$ ,  $a = 0(.1)2$ , 5D.
- [23.15] D. H. Lehmer, *On the maxima and minima of Bernoulli polynomials*, *Amer. Math. Monthly* **47**, 533–538 (1940).
- [23.16] E. O. Powell, *A table of the generalized Riemann Zeta function in a particular case*, *Quart. J. Mech. Appl. Math.* **5**, 116–123 (1952).  $\zeta(\frac{1}{2}, a)$ ,  $a = 1(.01)2(.02)5(.05)10$ , 10D.

# 24. Combinatorial Analysis

K. GOLDBERG,<sup>1</sup> M. NEWMAN,<sup>2</sup> E. HAYNSWORTH<sup>3</sup>

## Contents

|   | Page    |
|---|---------|
| <b>Mathematical Properties</b> . . . . .  | 822     |
| 24.1. Basic Numbers . . . . .   | 822     |
| 24.1.1 Binomial Coefficients . . . . .  | 822     |
| 24.1.2 Multinomial Coefficients . . . . .   | 823     |
| 24.1.3 Stirling Numbers of the First Kind . . . . .   | 824     |
| 24.1.4 Stirling Numbers of the Second Kind . . . . .  | 824     |
| 24.2. Partitions . . . . .  | 825     |
| 24.2.1 Unrestricted Partitions . . . . .  | 825     |
| 24.2.2 Partitions Into Distinct Parts . . . . .   | 825     |
| 24.3. Number Theoretic Functions . . . . .  | 826     |
| 24.3.1 The Möbius Function . . . . .  | 826     |
| 24.3.2 The Euler Function . . . . .   | 826     |
| 24.3.3 Divisor Functions . . . . .  | 827     |
| 24.3.4 Primitive Roots . . . . .  | 827     |
| <b>References</b> . . . . .   | 827     |
| <br><b>Table 24.1.</b> Binomial Coefficients $\binom{n}{m}$ . . . . .                       | <br>828 |
| $n \leq 50, m \leq 25$  |         |
| <br><b>Table 24.2.</b> Multinomials (Including a List of Partitions) . . . . .              | <br>831 |
| $n \leq 10$   |         |
| <br><b>Table 24.3.</b> Stirling Numbers of the First Kind $S_n^{(m)}$ . . . . .             | <br>833 |
| $n \leq 25$   |         |
| <br><b>Table 24.4.</b> Stirling Numbers of the Second Kind $\mathfrak{S}_n^{(m)}$ . . . . . | <br>835 |
| $n \leq 25$   |         |
| <br><b>Table 24.5.</b> Number of Partitions and Partitions Into Distinct Parts . .          | <br>836 |
| $p(n), q(n), n \leq 500$  |         |
| <br><b>Table 24.6.</b> Arithmetic Functions . . . . .                                       | <br>840 |
| $\varphi(n), \sigma_0(n), \sigma_1(n), n \leq 1000$   |         |
| <br><b>Table 24.7.</b> Factorizations . . . . .   | <br>844 |
| $n < 10000$   |         |
| <br><b>Table 24.8.</b> Primitive Roots, Factorization of $p-1$ . . . . .                    | <br>864 |
| $n < 10000$   |         |
| <br><b>Table 24.9.</b> Primes . . . . .   | <br>870 |
| $p \leq 10^5$   |         |

<sup>1, 2</sup> National Bureau of Standards.

<sup>3</sup> National Bureau of Standards. (Presently, Auburn University.)

# 24. Combinatorial Analysis

## Mathematical Properties

In each sub-section of this chapter we use a fixed format which emphasizes the use and methods of extending the accompanying tables. The format follows this form:

### I. Definitions

- A. Combinatorial
- B. Generating functions
- C. Closed form

### II. Relations

- A. Recurrences
- B. Checks in computing
- C. Basic use in numerical analysis

### III. Asymptotic and Special Values

In general the notations used are standard. This includes the difference operator  $\Delta$  defined on functions of  $x$  by  $\Delta f(x) = f(x+1) - f(x)$ ,  $\Delta^{n+1}f(x) = \Delta(\Delta^n f(x))$ , the Kronecker delta  $\delta_{ij}$ , the Riemann zeta function  $\zeta(s)$  and the greatest common divisor symbol  $(m, n)$ . The range of the summands for a summation sign without limits is explained to the right of the formula.

The notations which are not standard are those for the multinomials which are arbitrary shorthand for use in this chapter, and those for the Stirling numbers which have never been standardized. A short table of various notations for these numbers follows:

#### Notations for the Stirling Numbers

| Reference               | First Kind                       | Second Kind                  |
|-------------------------|----------------------------------|------------------------------|
| This chapter            | $S_n^{(m)}$                      | $\mathfrak{S}_n^{(m)}$       |
| [24.2] Fort             | $S_n^{(m)}$                      | $\mathcal{S}_n^{(m)}$ *      |
| [24.7] Jordan           | $S_n^m$                          | $\mathfrak{S}_n^m$ *         |
| [24.10] Moser and Wyman | $S_n^m$                          | $\sigma_n^m$                 |
| [24.9] Milne-Thomson    | $\binom{n-1}{m-1} B_{n-m}^{(n)}$ | $\binom{n}{m} B_{n-m}^{(n)}$ |
| [24.15] Riordan         | $s(n, m)$                        | $S(n, m)$                    |
| [24.1] Carlitz }        | $(-1)^{n-m} S_1(n-1, n-m)$       | $S_2(m, n-m)$                |
| [24.3] Gould }          |                                  |                              |
| Miksa                   | $S(n-m+1, n)$                    | ${}_m S_n$                   |
| (Unpublished tables)    |                                  |                              |
| [24.17] Gupta           |                                  | $u(n, m)$                    |

We feel that a capital  $S$  is natural for Stirling numbers of the first kind; it is infrequently used for other notation in this context. But once it is used we have difficulty finding a suitable symbol for Stirling numbers of the second kind. The numbers are sufficiently important to warrant

a special and easily recognizable symbol, and yet that symbol must be easy to write. We have settled on a script capital  $\mathfrak{S}$  without any certainty that we have settled this question permanently.

We feel that the subscript-superscript notation emphasizes the generating functions (which are powers of mutually inverse functions) from which most of the important relations flow.

### 24.1. Basic Numbers

#### 24.1.1 Binomial Coefficients

##### I. Definitions

A.  $\binom{n}{m}$  is the number of ways of choosing  $m$  objects from a collection of  $n$  distinct objects without regard to order.

B. Generating functions

$$* (1+x)^n = \sum_{m=0}^n \binom{n}{m} x^m \quad n=0, 1, \dots$$

$$(1-x)^{-m-1} = \sum_{n=m}^{\infty} \binom{n}{m} x^{n-m} \quad |x| < 1$$

C. Closed form

$$\binom{n}{m} = \frac{n!}{m!(n-m)!} = \binom{n}{n-m} \quad n \geq m$$

$$= \frac{n(n-1)\dots(n-m+1)}{m!}$$

##### II. Relations

A. Recurrences

$$\binom{n+1}{m} = \binom{n}{m} + \binom{n}{m-1} \quad n \geq m \geq 1$$

$$= \binom{n}{m} + \binom{n-1}{m-1} + \dots + \binom{n-m}{0} \quad n \geq m$$

B. Checks

$$\sum_{m=0}^n \binom{n}{m} \binom{s}{n-m} = \binom{r+s}{n} \quad r+s \geq n$$

$$\sum_{m=0}^n (-1)^{n-m} \binom{n}{m} = \binom{r-1}{n} \quad r \geq n+1$$

$$\binom{n}{m} \equiv \binom{n_0}{m_0} \binom{n_1}{m_1} \dots \pmod{p} \quad p \text{ a prime}$$



where

$$n = \sum_{k=0}^{\infty} n_k p^k, \quad m = \sum_{k=0}^{\infty} m_k p^k \quad p > m_k, n_k \geq 0$$

C. Numerical analysis

$$\begin{aligned} \Delta^n f(x) &= \sum_{m=0}^n (-1)^{n-m} \binom{n}{m} f(x+m) \\ &= \sum_{k=0}^r \binom{r}{k} \Delta^{n+k} f(x-r) \end{aligned}$$

$$\begin{aligned} \sum_{m=0}^s (-1)^m \binom{n}{m} f(x-m) \\ = \sum_{k=0}^s (-1)^{s-k} \binom{n-k-1}{s-k} \Delta^k f(x-s) \quad s < n \end{aligned}$$

III. Special Values

$$\binom{n}{0} = \binom{n}{n} = 1$$

$$\binom{2n}{n} = \frac{2^n (2n-1)(2n-3) \dots 3 \cdot 1}{n!}$$

24.1.2 Multinomial Coefficients

I. Definitions

A.  $(n; n_1, n_2, \dots, n_m)$  is the number of ways of putting  $n = n_1 + n_2 + \dots + n_m$  different objects into  $m$  different boxes with  $n_k$  in the  $k$ -th box,  $k = 1, 2, \dots, m$ .

$(n; a_1, a_2, \dots, a_n)^*$  is the number of permutations of  $n = a_1 + 2a_2 + \dots + na_n$  symbols composed of  $a_k$  cycles of length  $k$  for  $k = 1, 2, \dots, n$ .

$(n; a_1, a_2, \dots, a_n)'$  is the number of ways of partitioning a set of  $n = a_1 + 2a_2 + \dots + na_n$  different objects into  $a_k$  subsets containing  $k$  objects for  $k = 1, 2, \dots, n$ .

B. Generating functions

$$(x_1 + x_2 + \dots + x_m)^n = \Sigma(n; n_1, n_2, \dots, n_m) x_1^{n_1} x_2^{n_2} \dots x_m^{n_m} \quad \text{summed over } n_1 + n_2 + \dots + n_m = n$$

$$\left( \sum_{k=1}^{\infty} \frac{x_k}{k} t^k \right)^m = m! \sum_{n=m}^{\infty} \frac{t^n}{n!} \Sigma(n; a_1, a_2, \dots, a_n)^* x_1^{a_1} x_2^{a_2} \dots x_n^{a_n} \quad \text{summed over } a_1 + 2a_2 + \dots + na_n = n$$

$$\left( \sum_{k=1}^{\infty} \frac{x_k}{k!} t^k \right)^m = m! \sum_{n=m}^{\infty} \frac{t^n}{n!} \Sigma(n; a_1, a_2, \dots, a_n)' x_1^{a_1} x_2^{a_2} \dots x_n^{a_n} \quad \text{and } a_1 + a_2 + \dots + a_n = m$$

C. Closed forms

$$(n; n_1, n_2, \dots, n_m) = n! / n_1! n_2! \dots n_m! \quad n_1 + n_2 + \dots + n_m = n$$

$$(n; a_1, a_2, \dots, a_n)^* = n! / 1^{a_1} a_1! 2^{a_2} a_2! \dots n^{a_n} a_n! \quad a_1 + 2a_2 + \dots + na_n = n$$

$$(n; a_1, a_2, \dots, a_n)' = n! / (1!)^{a_1} a_1! (2!)^{a_2} a_2! \dots (n!)^{a_n} a_n! \quad a_1 + 2a_2 + \dots + na_n = n$$

II. Relations

A. Recurrence

$$(n+m; n_1+1, n_2+1, \dots, n_m+1) = \sum_{k=1}^m (n+m-1; n_1+1, \dots, n_{k-1}+1, n_k, n_{k+1}+1, \dots, n_m+1)$$

B. Checks

$$* \Sigma(n; n_1, n_2, \dots, n_m) = \begin{cases} m^n & \text{all } n_i \geq 1 \\ m! S_n^{(m)} & \end{cases} \quad \text{summed over } n_1 + n_2 + \dots + n_m = n$$

$$\Sigma(n; a_1, a_2, \dots, a_n)^* = (-1)^{n-m} S_n^{(m)} \quad \text{summed over } a_1 + 2a_2 + \dots + na_n = n \text{ and } a_1 + a_2 + \dots + a_n = m$$

$$\Sigma(n; a_1, a_2, \dots, a_n)' = S_n^{(m)}$$

C. Numerical analysis (Faà di Bruno's formula)

$$\frac{d^n}{dx^n} f(g(x)) = \sum_{m=0}^n f^{(m)}(g(x)) \Sigma(n; a_1, a_2, \dots, a_n)' \{g'(x)\}^{a_1} \{g''(x)\}^{a_2} \dots \{g^{(n)}(x)\}^{a_n}$$

summed over  $a_1 + 2a_2 + \dots + na_n = n$  and  $a_1 + a_2 + \dots + a_n = m$ .

\*See page II.

$$\begin{vmatrix}
 P_1 & 1 & 0 & \dots & 0 \\
 P_2 & P_1 & 2 & \dots & . \\
 P_3 & P_2 & P_1 & \dots & . \\
 . & . & . & \dots & . \\
 . & . & . & \dots & 0 \\
 . & . & . & \dots & n-1 \\
 P_n & P_{n-1} & P_{n-2} & \dots & P_1
 \end{vmatrix} = \Sigma (-1)^{n-2a_1} (n; a_1, a_2, \dots, a_n) * P_1^{a_1} P_2^{a_2} \dots P_n^{a_n}$$

summed over  $a_1+2a_2+\dots+na_n=n$ ; e.g. if  $P_k=\Sigma_{j=1}^k x_j^k$  for  $k=1, 2, \dots, n$  then the determinant and sum equal  $n! \Sigma x_1 x_2 \dots x_n$ , the latter sum denoting the  $n$ -th elementary symmetric function of  $x_1, x_2, \dots, x_r$ .

24.1.3 Stirling Numbers of the First Kind

I. Definitions

A.  $(-1)^{n-m} S_n^{(m)}$  is the number of permutations of  $n$  symbols which have exactly  $m$  cycles.

B. Generating functions

$$x(x-1)\dots(x-n+1) = \sum_{m=0}^n S_n^{(m)} x^m$$

$$\{\ln(1+x)\}^m = m! \sum_{n=m}^{\infty} S_n^{(m)} \frac{x^n}{n!} \quad |x| < 1$$

C. Closed form (see closed form for  $\mathfrak{S}_n^{(m)}$ )

$$S_n^{(m)} = \sum_{k=0}^{n-m} (-1)^k \binom{n-1+k}{n-m+k} \binom{2n-m}{n-m-k} \mathfrak{S}_{n-m+k}^{(k)}$$

II. Relations

A. Recurrences

$$S_{n+1}^{(m)} = S_n^{(m-1)} - n S_n^{(m)} \quad n \geq m \geq 1$$

$$\binom{m}{r} S_n^{(m)} = \sum_{k=m-r}^{n-r} \binom{n}{k} S_{n-k}^{(r)} S_k^{(m-r)} \quad n \geq m \geq r$$

B. Checks

$$\sum_{m=1}^n S_n^{(m)} = 0 \quad n > 1$$

$$\sum_{m=0}^n (-1)^{n-m} S_n^{(m)} = n!$$

$$\sum_{k=m}^n S_{n+1}^{(k+1)} n^{k-m} = S_n^{(m)}$$

C. Numerical analysis

$$\frac{d^m}{dx^m} f(x) = m! \sum_{n=m}^{\infty} \frac{S_n^{(m)}}{n!} \Delta^n f(x)$$

if convergent.

III. Asymptotics and Special Values

$$|S_n^{(m)}| \sim (n-1)! (\gamma + \ln n)^{m-1} / (m-1)! \quad \text{for } m = o(\ln n)$$

$$\lim_{m \rightarrow \infty} \frac{S_{n+m}^{(m)}}{m^{2n}} = \frac{(-1)^n}{2^n n!}$$

$$\lim_{n \rightarrow \infty} \frac{S_{n+1}^{(m)}}{n S_n^{(m)}} = -1$$

$$S_n^{(0)} = \delta_{0n}$$

$$S_n^{(1)} = (-1)^{n-1} (n-1)!$$

$$S_n^{(n-1)} = -\binom{n}{2}$$

$$S_n^{(n)} = 1$$

24.1.4 Stirling Numbers of the Second Kind

I. Definitions

A.  $\mathfrak{S}_n^{(m)}$  is the number of ways of partitioning a set of  $n$  elements into  $m$  non-empty subsets.

B. Generating functions

$$x^n = \sum_{m=0}^n \mathfrak{S}_n^{(m)} x(x-1)\dots(x-m+1)$$

$$(e^x - 1)^m = m! \sum_{n=m}^{\infty} \mathfrak{S}_n^{(m)} \frac{x^n}{n!}$$

$$(1-x)^{-1} (1-2x)^{-1} \dots (1-mx)^{-1} = \sum_{n=m}^{\infty} \mathfrak{S}_n^{(m)} x^{n-m} \quad |x| < m^{-1}$$

C. Closed form

$$\mathfrak{S}_n^{(m)} = \frac{1}{m!} \sum_{k=0}^m (-1)^{m-k} \binom{m}{k} k^n$$

II. Relations

A. Recurrences

$$\mathfrak{S}_{n+1}^{(m)} = m \mathfrak{S}_n^{(m)} + \mathfrak{S}_n^{(m-1)} \quad n \geq m \geq 1$$

$$\binom{m}{r} \mathfrak{S}_n^{(m)} = \sum_{k=m-r}^{n-r} \binom{n}{k} \mathfrak{S}_{n-k}^{(r)} \mathfrak{S}_k^{(m-r)} \quad n \geq m \geq r$$

B. Checks

$$\sum_{m=0}^n (-1)^{n-m} m! \mathfrak{S}_n^{(m)} = 1$$

$$\sum_{k=m}^n \mathfrak{S}_{k-1}^{(m-1)} m^{n-k} = \mathfrak{S}_n^{(m)}$$

$$\mathfrak{S}_n^{(m)} = \sum_{k=0}^{n-m} (-1)^k \binom{n-1+k}{n-m+k} \binom{2n-m}{n-m-k} \mathfrak{S}_{n-m+k}^{(k)}$$

$$\sum_{k=m}^n \mathfrak{S}_k^{(m)} \mathfrak{S}_n^{(k)} = \sum_{k=m}^n \mathfrak{S}_n^{(k)} \mathfrak{S}_k^{(m)} = \delta_{mn}$$

C. Numerical analysis

$$\Delta^m f(x) = m! \sum_{n=m}^{\infty} \frac{\mathfrak{S}_n^{(m)}}{n!} f^{(n)}(x) \quad \text{if convergent}$$

$$\sum_{k=0}^n k^m = \sum_{k=0}^m k! \mathfrak{S}_m^{(k)} \binom{n+1}{k+1}$$

$$\sum_{k=0}^n k^m x^k = \sum_{j=0}^m \mathfrak{S}_m^{(j)} x^j \frac{d^j}{dx^j} \left\{ \frac{1-x^{n+1}}{1-x} \right\}$$

III. Asymptotics and Special Values

$$* \lim_{n \rightarrow \infty} m^{-n} \mathfrak{S}_n^{(m)} = (m!)^{-1}$$

$$\mathfrak{S}_{n+m}^{(m)} \sim \frac{m^{2n}}{2^n n!} \quad \text{for } n = o(m^{\frac{1}{2}})$$

$$\lim_{n \rightarrow \infty} \frac{\mathfrak{S}_{n+1}^{(m)}}{\mathfrak{S}_n^{(m)}} = m$$

$$\mathfrak{S}_n^{(0)} = \delta_{0n}$$

$$\mathfrak{S}_n^{(1)} = \mathfrak{S}_n^{(n)} = 1$$

$$\mathfrak{S}_n^{(n-1)} = \binom{n}{2}$$

24.2. Partitions

24.2.1 Unrestricted Partitions

I. Definitions

A.  $p(n)$  is the number of decompositions of  $n$  into integer summands without regard to order. E.g.,  $5 = 1 + 4 = 2 + 3 = 1 + 1 + 3 = 1 + 2 + 2 = 1 + 1 + 1 + 2 = 1 + 1 + 1 + 1 + 1$  so that  $p(5) = 7$ .

\*See page 11.

B. Generating function

$$\sum_{n=0}^{\infty} p(n) x^n = \prod_{n=1}^{\infty} (1-x^n)^{-1} = \left\{ \sum_{n=-\infty}^{\infty} (-1)^n x^{\frac{3n^2+n}{2}} \right\}^{-1} \quad |x| < 1$$

C. Closed form

$$p(n) = \frac{1}{\pi\sqrt{2}} \sum_{k=1}^{\infty} \sqrt{k} A_k(n) \frac{d}{dn} \frac{\sinh \left\{ \frac{\pi}{k} \sqrt{\frac{2}{3}} \sqrt{n-\frac{1}{24}} \right\}}{\sqrt{n-\frac{1}{24}}}$$

where

$$A_k(n) = \sum_{\substack{0 < h \leq k \\ (h, k) = 1}} e^{\pi i s(h, k)} e^{-\frac{2\pi i h n}{k}}$$

$$s(h, k) = \sum_{j=1}^{k-1} \frac{j}{k} \left( \left( \frac{hj}{k} \right) \right)$$

$$\begin{aligned} ((x)) &= x - [x] - \frac{1}{2} \quad \text{if } x \text{ is not an integer} \\ &= 0 \quad \text{if } x \text{ is an integer} \end{aligned}$$

II. Relations

A. Recurrence

$$\begin{aligned} p(n) &= \sum_{1 \leq \frac{3k^2 \pm k}{2} \leq n} (-1)^{k-1} p\left(n - \frac{3k^2 \pm k}{2}\right) \quad p(0) = 1 \\ &= \frac{1}{n} \sum_{k=1}^n \sigma_1(k) p(n-k) \end{aligned}$$

B. Check

$$p(n) + \sum_{1 \leq \frac{3k^2 \pm k}{2} \leq n} (-1)^k \frac{3k^2 \pm k}{2} p\left(n - \frac{3k^2 \pm k}{2}\right) = \sigma_1(n)$$

III. Asymptotics

$$p(n) \sim \frac{1}{4n\sqrt{3}} e^{\pi\sqrt{\frac{2}{3}}\sqrt{n}}$$

24.2.2 Partitions Into Distinct Parts

I. Definitions

A.  $q(n)$  is the number of decompositions of  $n$  into distinct integer summands without regard to order. E.g.,  $5 = 1 + 4 = 2 + 3$  so that  $q(5) = 3$ .

B. Generating function

$$\sum_{n=0}^{\infty} q(n) x^n = \prod_{n=1}^{\infty} (1+x^n) = \prod_{n=1}^{\infty} (1-x^{2n-1})^{-1} \quad |x| < 1$$

C. Closed form

$$q(n) = \frac{1}{\sqrt{2}} \sum_{k=1}^{\infty} A_{2k-1}(n) \frac{d}{dn} J_0 \left( \frac{\pi i}{2k-1} \sqrt{\frac{1}{3}} \sqrt{n+\frac{1}{24}} \right)$$

where  $J_0(x)$  is the Bessel function of order 0 and  $A_{2k-1}(n)$  was defined in part I.C. of the previous subsection.

II. Relations

A. Recurrences

$$\sum_{0 \leq \frac{3k^2 \pm k}{2} \leq n} (-1)^k q\left(n - \frac{3k^2 \pm k}{2}\right) = (-1)^r \text{ if } n = 3r^2 \pm r$$

$$q(0) = 1$$

$$= 0 \text{ otherwise}$$

$$q(n) = \frac{1}{n} \sum_{k=1}^n \left\{ \sigma_1(k) - 2\sigma_1\left(\frac{k}{2}\right) \right\} q(n-k)$$

B. Check

$$\sum_{0 \leq 3k^2 \pm k \leq n} (-1)^k q(n - (3k^2 \pm k)) = 1 \text{ if } n = \frac{r^2 - r}{2}$$

$$= 0 \text{ otherwise.}$$

III. Asymptotics

$$q(n) \sim \frac{1}{4 \cdot 3^{1/4} \cdot n^{3/4}} e^{\pi \sqrt{1/3} \sqrt{n}}$$

24.3. Number Theoretic Functions

24.3.1 The Möbius Function

I. Definitions

- A.  $\mu(n) = 1$  if  $n = 1$
- $= (-1)^k$  if  $n$  is the product of  $k$  distinct primes
- $= 0$  if  $n$  is divisible by a square  $> 1$ .

B. Generating functions

$$\sum_{n=1}^{\infty} \mu(n) n^{-s} = 1/\zeta(s) \quad \Re s > 1$$

$$\sum_{n=1}^{\infty} \frac{\mu(n) x^n}{1-x^n} = x \quad |x| < 1$$

II. Relations

A. Recurrence

$$\mu(mn) = \mu(m)\mu(n) \text{ if } (m, n) = 1$$

$$= 0 \text{ if } (m, n) > 1$$

B. Check

$$\sum_{d|n} \mu(d) = \delta_{n1}$$

C. Numerical analysis

$$g(n) = \sum_{d|n} f(d) \text{ for all } n \text{ if and only if}$$

$$f(n) = \sum_{d|n} \mu(d) g(n/d) \text{ for all } n$$

$$g(n) = \prod_{d|n} f(d) \text{ for all } n \text{ if and only if}$$

$$f(n) = \prod_{d|n} g(n/d)^{\mu(d)} \text{ for all } n$$

$$g(x) = \sum_{n=1}^{[x]} f(x/n) \text{ for all } x > 0 \text{ if and only if}$$

$$f(x) = \sum_{n=1}^{[x]} \mu(n) g(x/n) \text{ for all } x > 0$$

$$g(x) = \sum_{n=1}^{\infty} f(nx) \text{ for all } x > 0 \text{ if and only if}$$

$$f(x) = \sum_{n=1}^{\infty} \mu(n) g(nx) \text{ for all } x > 0$$

and if  $\sum_{m=1}^{\infty} \sum_{n=1}^{\infty} |f(mnx)| = \sum_{n=1}^{\infty} \sigma_0(n) |f(nx)|$  converges.

The cyclotomic polynomial of order  $n$  is  $\prod_{d|n} (x^d - 1)^{\mu(n/d)}$

III. Asymptotics

$$\sum_{n=1}^{\infty} \frac{\mu(n)}{n} = 0$$

$$\sum_{n=1}^{\infty} \frac{\mu(n)}{n} \ln n = -1$$

$$\sum_{n \leq x} \mu(n) = O(xe^{-c\sqrt{\ln x}})$$

24.3.2 The Euler Totient Function

I. Definitions

A.  $\varphi(n)$  is the number of integers not exceeding and relatively prime to  $n$ .

B. Generating functions

$$\sum_{n=1}^{\infty} \varphi(n) n^{-s} = \frac{\zeta(s-1)}{\zeta(s)} \quad \Re s > 2$$

$$\sum_{n=1}^{\infty} \frac{\varphi(n) x^n}{1-x^n} = \frac{x}{(1-x)^2} \quad |x| < 1$$

C. Closed form

$$\varphi(n) = n \prod_{p|n} \left(1 - \frac{1}{p}\right)$$

over distinct primes  $p$  dividing  $n$ .

II. Relations

A. Recurrence

$$\varphi(mn) = \varphi(m)\varphi(n) \quad (m, n) = 1$$

B. Checks

$$\sum_{d|n} \varphi(d) = n$$

$$\varphi(n) = \sum_{d|n} \mu\left(\frac{n}{d}\right) d$$

$$a^{\varphi(n)} \equiv 1 \pmod{n} \quad (a, n) = 1$$

III. Asymptotics

$$\frac{1}{n^2} \sum_{k=1}^n \varphi(k) = \frac{3}{\pi^2} + O\left(\frac{\ln n}{n}\right)$$

24.3.3 Divisor Functions

I. Definitions

A.  $\sigma_k(n)$  is the sum of the  $k$ -th powers of the divisors of  $n$ . Often  $\sigma_0(n)$  is denoted by  $d(n)$ , and  $\sigma_1(n)$  by  $\sigma(n)$ .

B. Generating functions

$$\sum_{n=1}^{\infty} \sigma_k(n)n^{-s} = \zeta(s)\zeta(s-k) \quad \Re s > k+1$$

$$\sum_{n=1}^{\infty} \sigma_k(n)x^n = \sum_{n=1}^{\infty} \frac{n^k x^n}{1-x^n} \quad |x| < 1$$

C. Closed form

$$\sigma_k(n) = \sum_{d|n} d^k = \prod_{i=1}^s \frac{p_i^{k(a_i+1)} - 1}{p_i^k - 1} \quad n = p_1^{a_1} p_2^{a_2} \dots p_s^{a_s}$$

II. Relations

A. Recurrences

$$\sigma_k(mn) = \sigma_k(m)\sigma_k(n) \quad (m, n) = 1$$

$$\sigma_k(np) = \sigma_k(n)\sigma_k(p) - p^k \sigma_k(n/p) \quad p \text{ prime}$$

III. Asymptotics

$$\frac{1}{n} \sum_{m=1}^n \sigma_0(m) = \ln n + 2\gamma - 1 + O(n^{-1})$$

( $\gamma$ =Euler's constant)

$$\frac{1}{n^2} \sum_{m=1}^n \sigma_1(m) = \frac{\pi^2}{12} + O\left(\frac{\ln n}{n}\right)$$

24.3.4 Primitive Roots

I. Definitions

The integers not exceeding and relatively prime to a fixed integer  $n$  form a group; the group is cyclic if and only if  $n=2, 4$  or  $n$  is of the form  $p^k$  or  $2p^k$  where  $p$  is an odd prime. Then  $g$  is a primitive root of  $n$  if it generates that group; i.e., if  $g, g^2, \dots, g^{\varphi(n)}$  are distinct modulo  $n$ . There are  $\varphi(\varphi(n))$  primitive roots of  $n$ .

II. Relations

A. Recurrences. If  $g$  is a primitive root of a prime  $p$  and  $g^{p-1} \not\equiv 1 \pmod{p^2}$  then  $g$  is a primitive root of  $p^k$  for all  $k$ . If  $g^{p-1} \equiv 1 \pmod{p^2}$  then  $g+p$  is a primitive root of  $p^k$  for all  $k$ .

If  $g$  is a primitive root of  $p^k$  then either  $g$  or  $g+p^k$ , whichever is odd, is a primitive root of  $2p^k$ .

B. Checks. If  $g$  is a primitive root of  $n$  then  $g^k$  is a primitive root of  $n$  if and only if  $(k, \varphi(n)) = 1$ , and each primitive root of  $n$  is of this form.

References

Texts

[24.1] L. Carlitz, Note on Nörlunds polynomial  $B_n^{(s)}$ , Proc. Amer. Math. Soc. **11**, 452-455 (1960).  
 [24.2] T. Fort, Finite differences (Clarendon Press, Oxford, England, 1948).  
 [24.3] H. W. Gould, Stirling number representation problems, Proc. Amer. Math. Soc. **11**, 447-451 (1960).  
 [24.4] G. H. Hardy, Ramanujan (Chelsea Publishing Co., New York, N.Y., 1959).  
 [24.5] G. H. Hardy and E. M. Wright, An introduction to the theory of numbers, 4th ed. (Clarendon Press, Oxford, England, 1960).  
 [24.6] L. K. Hua, On the number of partitions of a number into unequal parts, Trans. Amer. Math. Soc. **51**, 194-201 (1942).  
 [24.7] C. Jordan, Calculus of finite differences, 2d ed. (Chelsea Publishing Co., New York, N.Y., 1960).  
 [24.8] K. Knopp, Theory and application of infinite series (Blackie and Son, Ltd., London, England, 1951).  
 [24.9] L. M. Milne-Thomson, The calculus of finite differences (Macmillan and Co., Ltd., London, England, 1951).  
 [24.10] L. Moser and M. Wyman, Stirling numbers of the second kind, Duke Math. J. **25**, 29-43 (1958).  
 [24.11] L. Moser and M. Wyman, Asymptotic development of the Stirling numbers of the first kind, J. London Math. Soc. **33**, 133-146 (1958).  
 [24.12] H. H. Ostmann, Additive Zahlentheorie, vol. I (Springer-Verlag, Berlin, Germany, 1956).

[24.13] H. Rademacher, On the partition function, Proc. London Math. Soc. **43**, 241-254 (1937).  
 [24.14] H. Rademacher and A. Whiteman, Theorems on Dedekind sums, Amer. J. Math. **63**, 377-407 (1941).  
 [24.15] J. Riordan, An introduction to combinatorial analysis (John Wiley & Sons, Inc., New York, N.Y., 1958).  
 [24.16] J. V. Uspensky and M. A. Heaslet, Elementary number theory (McGraw-Hill Book Co., Inc., New York, N.Y., 1939).

Tables

[24.17] British Association for the Advancement of Science, Mathematical Tables, vol. VIII, Number-divisor tables (Cambridge Univ. Press, Cambridge, England, 1940).  $n \leq 10^4$ .  
 [24.18] H. Gupta, Tables of distributions, Res. Bull. East Punjab Univ. 13-44 (1950); 750 (1951).  
 [24.19] H. Gupta, A table of partitions, Proc. London Math. Soc. **39**, 142-149 (1935) and II. **42**, 546-549 (1937).  $p(n), n=1(1)300; p(n), n=301(1)600$ .  
 [24.20] G. Kavan, Factor tables (Macmillan and Co., Ltd., London, England, 1937).  $n \leq 256,000$ .  
 [24.21] D. N. Lehmer, List of prime numbers from 1 to 10,006,721, Carnegie Institution of Washington, Publication No. 165, Washington, D.C. (1914).  
 [24.22] Royal Society Mathematical Tables, vol. 3, Table of binomial coefficients (Cambridge Univ. Press, Cambridge, England, 1954).  $\binom{n}{r}$  for  $r \leq \frac{1}{2}n \leq 100$ .  
 [24.23] G. N. Watson, Two tables of partitions, Proc. London Math. Soc. **42**, 550-556 (1937).



# 25. Numerical Interpolation, Differentiation, and Integration

PHILIP J. DAVIS<sup>1</sup> AND IVAN POLONSKY<sup>2</sup>

## Contents

| Formulas  | Page |
|---|------|
| 25.1. Differences . . . . .   | 877  |
| 25.2. Interpolation . . . . .   | 878  |
| 25.3. Differentiation . . . . .   | 882  |
| 25.4. Integration . . . . .   | 885  |
| 25.5. Ordinary Differential Equations . . . . .   | 896  |
| <b>References</b> . . . . .   | 898  |
| <b>Table 25.1.</b> <i>n</i> -Point Lagrangian Interpolation Coefficients ( $3 \leq n \leq 8$ ) . . . . .  | 900  |
| $n=3, 4, p=-\left[\frac{n-1}{2}\right] (.01) \left[\frac{n}{2}\right],$ Exact   |      |
| $n=5, 6, p=-\left[\frac{n-1}{2}\right] (.01) \left[\frac{n}{2}\right],$ 10D   |      |
| $n=7, 8, p=-\left[\frac{n-1}{2}\right] (.1) \left[\frac{n}{2}\right],$ 10D  |      |
| <b>Table 25.2.</b> <i>n</i> -Point Coefficients for <i>k</i> -th Order Differentiation<br>( $1 \leq k \leq 5$ ) . . . . .                                 | 914  |
| $k=1, n=3(1)6,$ Exact   |      |
| $k=2(1)5, n=k+1(1)6,$ Exact   |      |
| <b>Table 25.3.</b> <i>n</i> -Point Lagrangian Integration Coefficients ( $3 \leq n \leq 10$ ) . . . . .   | 915  |
| $n=3(1)10,$ Exact   |      |
| <b>Table 25.4.</b> Abscissas and Weight Factors for Gaussian Integration<br>( $2 \leq n \leq 96$ ) . . . . .  | 916  |
| $n=2(1)10, 12,$ 15D   |      |
| $n=16(4)24(8)48(16)96,$ 21D   |      |
| <b>Table 25.5.</b> Abscissas for Equal Weight Chebyshev Integration<br>( $2 \leq n \leq 9$ ) . . . . .  | 920  |
| $n=2(1)7, 9,$ 10D   |      |
| <b>Table 25.6.</b> Abscissas and Weight Factors for Lobatto Integration<br>( $3 \leq n \leq 10$ ) . . . . .   | 920  |
| $n=3(1)10,$ 8-10D   |      |
| <b>Table 25.7.</b> Abscissas and Weight Factors for Gaussian Integration<br>for Integrands with a Logarithmic Singularity ( $2 \leq n \leq 4$ ) . . . . . | 920  |
| $n=2(1)4,$ 6D   |      |

<sup>1</sup> National Bureau of Standards.

<sup>2</sup> National Bureau of Standards. (Presently, Bell Tel. Labs., Whippany, N.J.)



# 25. Numerical Interpolation, Differentiation, and Integration

Numerical analysts have a tendency to accumulate a multiplicity of tools each designed for highly specialized operations and each requiring special knowledge to use properly. From the vast stock of formulas available we have culled the present selection. We hope that it will be useful. As with all such compendia, the reader may miss his favorites and find others whose utility he thinks is marginal.

We would have liked to give examples to illuminate the formulas, but this has not been feasible. Numerical analysis is partially a science and partially an art, and short of writing a textbook on the subject it has been impossible to indicate where and under what circumstances the various formulas are useful or accurate, or to elucidate the numerical difficulties to which one might be led by uncritical use. The formulas are therefore issued together with a caveat against their blind application.

## Formulas

*Notation:* Abscissas:  $x_0 < x_1 < \dots$ ; functions:  $f, g, \dots$ ; values:  $f(x_i) = f_i, f'(x_i) = f'_i, f'', f^{(2)}, \dots$  indicate 1<sup>st</sup>, 2<sup>d</sup>,  $\dots$  derivatives. If abscissas are equally spaced,  $x_{i+1} - x_i = h$  and  $f_p = f(x_0 + ph)$  ( $p$  not necessarily integral).  $R, R_n$  indicate remainders.

### 25.1. Differences

#### Forward Differences

##### 25.1.1

$$\Delta(f_n) = \Delta_n = \Delta_n^1 = f_{n+1} - f_n$$

$$\Delta_n^2 = \Delta_{n+1}^1 - \Delta_n^1 = f_{n+2} - 2f_{n+1} + f_n$$

$$\Delta_n^3 = \Delta_{n+1}^2 - \Delta_n^2 = f_{n+3} - 3f_{n+2} + 3f_{n+1} - f_n$$

$$\Delta_n^k = \Delta_{n+1}^{k-1} - \Delta_n^{k-1} = \sum_{j=0}^{k-1} (-1)^j \binom{k}{j} f_{n+k-j}$$

#### Central Differences

##### 25.1.2

$$\delta(f_{n+\frac{1}{2}}) = \delta_{n+\frac{1}{2}} = \delta_{n+\frac{1}{2}}^1 = f_{n+1} - f_n$$

$$\delta_n^2 = \delta_{n+\frac{1}{2}}^1 - \delta_{n-\frac{1}{2}}^1 = f_{n+1} - 2f_n + f_{n-1}$$

$$\delta_{n+\frac{1}{2}}^3 = \delta_{n+1}^2 - \delta_n^2 = f_{n+2} - 3f_{n+1} + 3f_n - f_{n-1}$$

$$\delta_n^{2k} = \sum_{j=0}^{2k} (-1)^j \binom{2k}{j} f_{n+k-j}$$

$$\delta_{n+\frac{1}{2}}^{2k+1} = \sum_{j=0}^{2k+1} (-1)^j \binom{2k+1}{j} f_{n+k+1-j}$$

$$\delta_{\frac{1}{2}n}^k = \Delta_{\frac{1}{2}(n-k)}^k \text{ if } n \text{ and } k \text{ are of same parity.}$$

#### Forward Differences

#### Central Differences

|       |       |            |              |              |          |          |                         |              |                          |
|-------|-------|------------|--------------|--------------|----------|----------|-------------------------|--------------|--------------------------|
| $x_0$ | $f_0$ |            |              |              | $x_{-1}$ | $f_{-1}$ |                         |              |                          |
|       |       | $\Delta_0$ |              |              |          |          | $\delta_{-\frac{1}{2}}$ |              |                          |
| $x_1$ | $f_1$ |            | $\Delta_0^2$ |              | $x_0$    | $f_0$    |                         | $\delta_0^2$ |                          |
|       |       | $\Delta_1$ |              | $\Delta_0^3$ |          |          | $\delta_{\frac{1}{2}}$  |              | $\delta_{\frac{1}{2}}^3$ |
| $x_2$ | $f_2$ |            | $\Delta_1^2$ |              | $x_1$    | $f_1$    |                         | $\delta_1^2$ |                          |
|       |       | $\Delta_2$ |              |              |          |          | $\delta_{3/2}$          |              |                          |
| $x_3$ | $f_3$ |            |              |              | $x_2$    | $f_2$    |                         |              |                          |

#### Mean Differences

##### 25.1.3

$$\mu(f_n) = \frac{1}{2}(f_{n+\frac{1}{2}} + f_{n-\frac{1}{2}})$$

#### Divided Differences

##### 25.1.4

$$[x_0, x_1] = \frac{f_0 - f_1}{x_0 - x_1} = [x_1, x_0]$$

$$[x_0, x_1, x_2] = \frac{[x_0, x_1] - [x_1, x_2]}{x_0 - x_2}$$

$$[x_0, x_1, \dots, x_k] = \frac{[x_0, \dots, x_{k-1}] - [x_1, \dots, x_k]}{x_0 - x_k}$$

#### Divided Differences in Terms of Functional Values

##### 25.1.5

$$[x_0, x_1, \dots, x_n] = \sum_{k=0}^n \frac{f_k}{\pi_n'(x_k)}$$

**25.1.6** where  $\pi_n(x) = (x-x_0)(x-x_1)\dots(x-x_n)$  and  $\pi_n'(x)$  is its derivative:

**25.1.7**

$$\pi_n'(x_k) = (x_k - x_0) \dots (x_k - x_{k-1})(x_k - x_{k+1}) \dots (x_k - x_n)$$

Let  $D$  be a simply connected domain with a piecewise smooth boundary  $C$  and contain the points  $z_0, \dots, z_n$  in its interior. Let  $f(z)$  be analytic in  $D$  and continuous in  $D+C$ . Then,

**25.1.8**  $[z_0, z_1, \dots, z_n] = \frac{1}{2\pi i} \int_C \frac{f(z)}{\prod_{k=0}^n (z - z_k)} dz$

**25.1.9**  $\Delta_0^n = h^n f^{(n)}(\xi) \quad (x_0 < \xi < x_n)$

**25.1.10**

$$[x_0, x_1, \dots, x_n] = \frac{\Delta_0^n}{n! h^n} = \frac{f^{(n)}(\xi)}{n!} \quad (x_0 < \xi < x_n)$$

**25.1.11**

$$[x_{-n}, x_{-n+1}, \dots, x_0, \dots, x_n] = \frac{\delta_0^{2n}}{h^{2n}(2n)!}$$

#### Reciprocal Differences

**25.1.12**

$$\rho(x_0, x_1) = \frac{x_0 - x_1}{f_0 - f_1}$$

$$\rho_2(x_0, x_1, x_2) = \frac{x_0 - x_2}{\rho(x_0, x_1) - \rho(x_1, x_2)} + f_1$$

$$\rho_3(x_0, x_1, x_2, x_3) = \frac{x_0 - x_3}{\rho_2(x_0, x_1, x_2) - \rho_2(x_1, x_2, x_3)} + \rho(x_1, x_2)$$

$$\rho_n(x_0, x_1, \dots, x_n) = \frac{x_0 - x_n}{\rho_{n-1}(x_0, \dots, x_{n-1}) - \rho_{n-1}(x_1, \dots, x_n)} + \rho_{n-2}(x_1, \dots, x_{n-1})$$

### 25.2. Interpolation

#### Lagrange Interpolation Formulas

**25.2.1**  $f(x) = \sum_{i=0}^n l_i(x) f_i + R_n(x)$

**25.2.2**

$$l_i(x) = \frac{\pi_n(x)}{(x-x_i)\pi_n'(x_i)} = \frac{(x-x_0)\dots(x-x_{i-1})(x-x_{i+1})\dots(x-x_n)}{(x_i-x_0)\dots(x_i-x_{i-1})(x_i-x_{i+1})\dots(x_i-x_n)}$$

#### Remainder in Lagrange Interpolation Formula

**25.2.3**

$$R_n(x) = \pi_n(x) \cdot [x_0, x_1, \dots, x_n, x] = \pi_n(x) \cdot \frac{f^{(n+1)}(\xi)}{(n+1)!} \quad (x_0 < \xi < x_n)$$

**25.2.4**

$$|R_n(x)| \leq \frac{(x_n - x_0)^{n+1}}{(n+1)!} \max_{x_0 \leq x \leq x_n} |f^{(n+1)}(x)|$$

**25.2.5**

$$R_n(z) = \frac{\pi_n(z)}{2\pi i} \int_C \frac{f(t)}{(t-z)(t-z_0)\dots(t-z_n)} dt$$

The conditions of **25.1.8** are assumed here.

#### Lagrange Interpolation, Equally Spaced Abscissas

##### $n$ Point Formula

**25.2.6**  $f(x_0 + ph) = \sum_k A_k^n(p) f_k + R_{n-1}$

For  $n$  even,  $\left(-\frac{1}{2}(n-2) \leq k \leq \frac{1}{2}n\right)$ .

For  $n$  odd,  $\left(-\frac{1}{2}(n-1) \leq k \leq \frac{1}{2}(n-1)\right)$ .

**25.2.7**

$$A_k^n(p) = \frac{(-1)^{\frac{1}{2}n+k}}{\left(\frac{n-2}{2}+k\right)! \left(\frac{1}{2}n-k\right)! (p-k)} \prod_{t=1}^n \left(p + \frac{1}{2}n - t\right) \quad n \text{ even.}$$

$$A_k^n(p) = \frac{(-1)^{\frac{1}{2}(n-1)+k}}{\left(\frac{n-1}{2}+k\right)! \left(\frac{n-1}{2}-k\right)! (p-k)} \prod_{t=0}^{n-1} \left(p + \frac{n-1}{2} - t\right), \quad n \text{ odd.}$$

**25.2.8**

$$R_{n-1} = \frac{1}{n!} \prod_k (p-k) h^n f^{(n)}(\xi) \approx \frac{1}{n!} \prod_k (p-k) \Delta_0^n \quad (x_0 < \xi < x_n)$$

$k$  has the same range as in **25.2.6**.

#### Lagrange Two Point Interpolation Formula (Linear Interpolation)

**25.2.9**  $f(x_0 + ph) = (1-p)f_0 + pf_1 + R_1$

**25.2.10**  $R_1(p) \approx .125h^2 f^{(2)}(\xi) \approx .125\Delta^2$

**Lagrange Three Point Interpolation Formula**

**25.2.11**

$$f(x_0+ph) = A_{-1}f_{-1} + A_0f_0 + A_1f_1 + R_2$$

$$\approx \frac{p(p-1)}{2}f_{-1} + (1-p^2)f_0 + \frac{p(p+1)}{2}f_1$$

**25.2.12**

$$R_2(p) \approx .065h^3f^{(3)}(\xi) \approx .065\Delta^3 \quad (|p| \leq 1)$$

**Lagrange Four Point Interpolation Formula**

**25.2.13**

$$f(x_0+ph) = A_{-1}f_{-1} + A_0f_0 + A_1f_1 + A_2f_2 + R_3$$

$$\approx \frac{-p(p-1)(p-2)}{6}f_{-1} + \frac{(p^2-1)(p-2)}{2}f_0$$

$$- \frac{p(p+1)(p-2)}{2}f_1 + \frac{p(p^2-1)}{6}f_2$$

**25.2.14**

$$R_3(p) \approx$$

$$.024h^4f^{(4)}(\xi) \approx .024\Delta^4 \quad (0 < p < 1)$$

$$.042h^4f^{(4)}(\xi) \approx .042\Delta^4 \quad (-1 < p < 0, 1 < p < 2)$$

$$(x_{-1} < \xi < x_2)$$

**Lagrange Five Point Interpolation Formula**

**25.2.15**

$$f(x_0+ph) = \sum_{i=-2}^2 A_i f_i + R_4$$

$$\approx \frac{(p^2-1)p(p-2)}{24}f_{-2} - \frac{(p-1)p(p^2-4)}{6}f_{-1}$$

$$+ \frac{(p^2-1)(p^2-4)}{4}f_0 - \frac{(p+1)p(p^2-4)}{6}f_1$$

$$+ \frac{(p^2-1)p(p+2)}{24}f_2$$

**25.2.16**

$$R_4(p) \approx$$

$$.012h^5f^{(5)}(\xi) \approx .012\Delta^5 \quad (|p| < 1)$$

$$.031h^5f^{(5)}(\xi) \approx .031\Delta^5 \quad (1 < |p| < 2) \quad (x_{-2} < \xi < x_2)$$

**Lagrange Six Point Interpolation Formula**

**25.2.17**

$$f(x_0+ph) = \sum_{i=-2}^3 A_i f_i + R_5$$

$$\approx \frac{-p(p^2-1)(p-2)(p-3)}{120}f_{-2}$$

$$+ \frac{p(p-1)(p^2-4)(p-3)}{24}f_{-1}$$

$$- \frac{(p^2-1)(p^2-4)(p-3)}{12}f_0$$

$$+ \frac{p(p+1)(p^2-4)(p-3)}{12}f_1 - \frac{p(p^2-1)(p+2)(p-3)}{24}f_2$$

$$+ \frac{p(p^2-1)(p^2-4)}{120}f_3$$

**25.2.18**

$$R_5(p) \approx$$

$$.0049h^6f^{(6)}(\xi) \approx .0049\Delta^6 \quad (0 < p < 1)$$

$$.0071h^6f^{(6)}(\xi) \approx .0071\Delta^6 \quad (-1 < p < 0, 1 < p < 2)$$

$$.024h^6f^{(6)}(\xi) \approx .024\Delta^6 \quad (-2 < p < -1, 2 < p < 3)$$

$$(x_{-2} < \xi < x_3)$$

**Lagrange Seven Point Interpolation Formula**

**25.2.19**  $f(x_0+ph) = \sum_{i=-3}^3 A_i f_i + R_6$

**25.2.20**

$$R_6(p) \approx \begin{cases} .0025h^7f^{(7)}(\xi) \approx .0025\Delta^7 & (|p| < 1) \\ .0046h^7f^{(7)}(\xi) \approx .0046\Delta^7 & (1 < |p| < 2) \\ .019h^7f^{(7)}(\xi) \approx .019\Delta^7 & (2 < |p| < 3) \end{cases}$$

$$(x_{-3} < \xi < x_3)$$

**Lagrange Eight Point Interpolation Formula**

**25.2.21**  $f(x_0+ph) = \sum_{i=-3}^4 A_i f_i + R_7$

**25.2.22**

$$R_7(p) \approx \begin{cases} .0011h^8f^{(8)}(\xi) \approx .0011\Delta^8 & (0 < p < 1) \\ .0014h^8f^{(8)}(\xi) \approx .0014\Delta^8 & (-1 < p < 0) \\ & (1 < p < 2) \\ .0033h^8f^{(8)}(\xi) \approx .0033\Delta^8 & (-2 < p < -1) \\ & (2 < p < 3) \\ .016h^8f^{(8)}(\xi) \approx .016\Delta^8 & (-3 < p < -2) \\ & (3 < p < 4) \end{cases}$$

$$(x_{-3} < \xi < x_4)$$

**Aitken's Iteration Method**

Let  $f(x|x_0, x_1, \dots, x_k)$  denote the unique polynomial of  $k^{\text{th}}$  degree which coincides in value with  $f(x)$  at  $x_0, \dots, x_k$ .

**25.2.23**

$$f(x|x_0, x_1) = \frac{1}{x_1-x_0} \begin{vmatrix} f_0 & x_0-x \\ f_1 & x_1-x \end{vmatrix}$$

$$f(x|x_0, x_2) = \frac{1}{x_2-x_0} \begin{vmatrix} f_0 & x_0-x \\ f_2 & x_2-x \end{vmatrix}$$

$$f(x|x_0, x_1, x_2) = \frac{1}{x_2-x_1} \begin{vmatrix} f(x|x_0, x_1) & x_1-x \\ f(x|x_0, x_2) & x_2-x \end{vmatrix}$$

$$f(x|x_0, x_1, x_2, x_3) = \frac{1}{x_3-x_2} \begin{vmatrix} f(x|x_0, x_1, x_2) & x_2-x \\ f(x|x_0, x_1, x_3) & x_3-x \end{vmatrix}$$

**Taylor Expansion**

25.2.24

$$f(x) = f_0 + (x-x_0)f'_0 + \frac{(x-x_0)^2}{2!}f''_0 + \dots + \frac{(x-x_0)^n}{n!}f^{(n)}_0 + R_n$$

25.2.25

$$R_n = \int_{x_0}^x f^{(n+1)}(t) \frac{(x-t)^n}{n!} dt = \frac{(x-x_0)^{n+1}}{(n+1)!} f^{(n+1)}(\xi) \quad (x_0 < \xi < x)$$

**Newton's Divided Difference Interpolation Formula**

25.2.26

$$f(x) = f_0 + \sum_{k=1}^n \pi_{k-1}(x) [x_0, x_1, \dots, x_k] + R_n$$

|       |       |              |                        |
|-------|-------|--------------|------------------------|
| $x_0$ | $f_0$ | $[x_0, x_1]$ |                        |
| $x_1$ | $f_1$ | $[x_1, x_2]$ | $[x_0, x_1, x_2]$      |
| $x_2$ | $f_2$ | $[x_2, x_3]$ | $[x_0, x_1, x_2, x_3]$ |
| $x_3$ | $f_3$ |              |                        |

25.2.27

$$R_n(x) = \pi_n(x) [x_0, \dots, x_n, x] = \pi_n(x) \frac{f^{(n+1)}(\xi)}{(n+1)!} \quad (x_0 < \xi < x_n)$$

(For  $\pi_n$  see 25.1.6.)

**Newton's Forward Difference Formula**

25.2.28

$$f(x_0 + ph) = f_0 + p\Delta_0 + \binom{p}{2}\Delta_0^2 + \dots + \binom{p}{n}\Delta_0^n + R_n$$

|       |       |            |              |
|-------|-------|------------|--------------|
| $x_0$ | $f_0$ |            |              |
| $x_1$ | $f_1$ | $\Delta_0$ |              |
| $x_2$ | $f_2$ | $\Delta_1$ | $\Delta_0^2$ |
| $x_3$ | $f_3$ | $\Delta_2$ | $\Delta_1^2$ |

25.2.29

$$R_n = h^{n+1} \binom{p}{n+1} f^{(n+1)}(\xi) \approx \binom{p}{n+1} \Delta_0^{n+1} \quad (x_0 < \xi < x_n)$$

**Relation Between Newton and Lagrange Coefficients**

25.2.30

$$\binom{p}{2} = A_{-1}^2(p) \quad \binom{p}{3} = -A_{-1}^3(p) \quad \binom{p}{4} = A_2^4(1-p) \quad \binom{p}{5} = A_3^5(2-p)$$

**Everett's Formula**

25.2.31

$$f(x_0 + ph) = (1-p)f_0 + pf_1 - \frac{p(p-1)(p-2)}{3!}\delta_0^3 + \frac{(p+1)p(p-1)}{3!}\delta_1^3 + \dots - \binom{p+n-1}{2n+1}\delta_0^{2n} + \binom{p+n}{2n+1}\delta_1^{2n} + R_{2n} = (1-p)f_0 + pf_1 + E_2\delta_0^2 + F_2\delta_1^2 + E_4\delta_0^4 + F_4\delta_1^4 + \dots + R_{2n}$$

|       |       |              |              |
|-------|-------|--------------|--------------|
| $x_0$ | $f_0$ | $\delta_0^2$ | $\delta_0^4$ |
|       |       | $\delta_1^2$ | $\delta_1^4$ |
| $x_1$ | $f_1$ | $\delta_1^2$ | $\delta_1^4$ |

25.2.32

$$R_{2n} = h^{2n+2} \binom{p+n}{2n+2} f^{(2n+2)}(\xi) \approx \binom{p+n}{2n+2} \left[ \frac{\Delta_{-n-1}^{2n+2} + \Delta_{-n}^{2n+2}}{2} \right] \quad (x_{-n} < \xi < x_{n+1})$$

**Relation Between Everett and Lagrange Coefficients**

25.2.33

$$E_2 = A_{-1}^4 \quad E_4 = A_{-2}^6 \quad E_6 = A_{-3}^8 \quad F_2 = A_2^4 \quad F_4 = A_3^6 \quad F_6 = A_4^8$$

**Everett's Formula With Throwback (Modified Central Difference)**

25.2.34

$$f(x_0 + ph) = (1-p)f_0 + pf_1 + E_2\delta_{m,0}^2 + F_2\delta_{m,1}^2 + R$$

25.2.35

$$\delta_m^2 = \delta^2 - .184\delta^4$$

25.2.36

$$R \approx .00045|\mu\delta_1^4| + .00061|\delta_1^5|$$

25.2.37

$$f(x_0 + ph) = (1-p)f_0 + pf_1 + E_2\delta_0^2 + F_2\delta_1^2 + E_4\delta_{m,0}^4 + F_4\delta_{m,1}^4 + R$$

25.2.38

$$\delta_m^4 = \delta^4 - .207\delta^6 + \dots$$

25.2.39

$$R \approx .000032|\mu\delta_1^6| + .000052|\delta_1^7|$$

25.2.40

$$f(x_0 + ph) = (1-p)f_0 + pf_1 + E_2\delta_0^2 + F_2\delta_1^2 + E_4\delta_0^4 + F_4\delta_1^4 + E_6\delta_{m,0}^6 + F_6\delta_{m,1}^6 + R$$

25.2.41

$$\delta_m^6 = \delta^6 - .218\delta^8 + .049\delta^{10} + \dots$$

25.2.42

$$R \approx .0000037|\mu\delta_1^8| + \dots$$

**Simultaneous Throwback**

25.2.43

$$f(x_0 + ph) = (1-p)f_0 + pf_1 + E_2\delta_{m,0}^2 + F_2\delta_{m,1}^2 + E_4\delta_{m,0}^4 + F_4\delta_{m,1}^4 + R$$

25.2.44  $\delta_m^2 = \delta^2 - .01312\delta^6 + .0043\delta^8 - .001\delta^{10}$

25.2.45  $\delta_m^4 = \delta^4 - .27827\delta^6 + .0685\delta^8 - .016\delta^{10}$

25.2.46  $R \approx .00000083|\mu\delta_3^5| + .0000094\delta^7$

**Bessel's Formula With Throwback**

25.2.47

$$f(x_0 + ph) = (1-p)f_0 + pf_1 + B_2(\delta_{m,0}^2 + \delta_{m,1}^2) + B_3\delta_3^3 + R, B_2 = \frac{p(p-1)}{4}, B_3 = \frac{p(p-1)(p-\frac{1}{2})}{6}$$

25.2.48  $\delta_m^2 = \delta^2 - .184\delta^4$

25.2.49  $R \approx .00045|\mu\delta_3^4| + .00087|\delta_3^5|$

**Thiele's Interpolation Formula**

25.2.50

$$f(x) = f(x_1) + \frac{x-x_1}{\rho(x_1, x_2) + x-x_2} \frac{\rho_2(x_1, x_2, x_3) - f(x_1) + x-x_3}{\left( \begin{matrix} \rho_3(x_1, x_2, x_3, x_4) \\ -\rho(x_1, x_2) + \dots \end{matrix} \right)}$$

(For reciprocal differences,  $\rho$ , see 25.1.12.)

**Trigonometric Interpolation**

**Gauss' Formula**

25.2.51  $f(x) \approx \sum_{k=0}^{2n} f_k \zeta_k(x) = t_n(x)$

25.2.52

$$\zeta_k(x) = \frac{\sin \frac{1}{2}(x-x_0) \dots \sin \frac{1}{2}(x-x_{k-1})}{\sin \frac{1}{2}(x_k-x_0) \dots \sin \frac{1}{2}(x_k-x_{k-1})} \frac{\sin \frac{1}{2}(x-x_{k+1}) \dots \sin \frac{1}{2}(x-x_{2n})}{\sin \frac{1}{2}(x_k-x_{k+1}) \dots \sin \frac{1}{2}(x_k-x_{2n})}$$

$t_n(x)$  is a trigonometric polynomial of degree  $n$  such that  $t_n(x_k) = f_k$  ( $k=0, 1, \dots, 2n$ )

**Harmonic Analysis**

Equally spaced abscissas

$$x_0 = 0, \quad x_1, \dots, x_{m-1}, x_m = 2\pi$$

25.2.53

$$f(x) \approx \frac{1}{2} a_0 + \sum_{k=1}^n (a_k \cos kx + b_k \sin kx)$$

25.2.54

$$m = 2n + 1$$

$$a_k = \frac{2}{2n+1} \sum_{r=0}^{2n} f_r \cos kx_r; \quad b_k = \frac{2}{2n+1} \sum_{r=0}^{2n} f_r \sin kx_r \quad (k=0, 1, \dots, n)$$

25.2.55

$$m = 2n$$

$$a_k = \frac{1}{n} \sum_{r=0}^{2n-1} f_r \cos kx_r; \quad b_k = \frac{1}{n} \sum_{r=0}^{2n-1} f_r \sin kx_r \quad (k=0, 1, \dots, n) \quad (k=0, 1, \dots, n-1)$$

$b_n$  is arbitrary.

**Subtabulation**

Let  $f(x)$  be tabulated initially in intervals of width  $h$ . It is desired to subtabulate  $f(x)$  in intervals of width  $h/m$ . Let  $\Delta$  and  $\bar{\Delta}$  designate differences with respect to the original and the final intervals respectively. Thus  $\bar{\Delta}_0 = f(x_0 + \frac{h}{m}) - f(x_0)$ . Assuming that the original 5<sup>th</sup> order differences are zero,

25.2.56

$$\bar{\Delta}_0 = \frac{1}{m} \Delta_0 + \frac{1-m}{2m^2} \Delta_0^2 + \frac{(1-m)(1-2m)}{6m^3} \Delta_0^3 + \frac{(1-m)(1-2m)(1-3m)}{24m^4} \Delta_0^4$$

$$\bar{\Delta}_0^2 = \frac{1}{m^2} \Delta_0^2 + \frac{1-m}{m^3} \Delta_0^3 + \frac{(1-m)(7-11m)}{12m^4} \Delta_0^4$$

$$\bar{\Delta}_0^3 = \frac{1}{m^3} \Delta_0^3 + \frac{3(1-m)}{2m^4} \Delta_0^4$$

$$\bar{\Delta}_0^4 = \frac{1}{m^4} \Delta_0^4$$

From this information we may construct the final tabulation by addition. For  $m=10$ ,

25.2.57

$$\bar{\Delta}_0 = .1\Delta_0 - .045\Delta_0^2 + .0285\Delta_0^3 - .02066\Delta_0^4$$

$$\bar{\Delta}_0^2 = .01\Delta_0^2 - .009\Delta_0^3 + .007725\Delta_0^4$$

$$\bar{\Delta}_0^3 = .001\Delta_0^3 - .00135\Delta_0^4$$

$$\bar{\Delta}_0^4 = .0001\Delta_0^4$$

**Linear Inverse Interpolation**

Find  $p$ , given  $f_p (= f(x_0 + ph))$ .

Linear

25.2.58

$$p \approx \frac{f_p - f_0}{f_1 - f_0}$$

**Quadratic Inverse Interpolation**

25.2.59

$$(f_1 - 2f_0 + f_{-1})p^2 + (f_1 - f_{-1})p + 2(f_0 - f_p) \approx 0$$

**Inverse Interpolation by Reversion of Series**25.2.60 Given  $f(x_0 + ph) = f_p = \sum_{k=0}^{\infty} a_k p^k$ 

25.2.61

$$p = \lambda + c_2 \lambda^2 + c_3 \lambda^3 + \dots, \quad \lambda = (f_p - a_0) / a_1$$

25.2.62

$$c_2 = -a_2 / a_1$$

$$c_3 = \frac{-a_3}{a_1} + 2 \left( \frac{a_2}{a_1} \right)^2$$

$$c_4 = \frac{-a_4}{a_1} + \frac{5a_2 a_3}{a_1^2} - \frac{5a_2^3}{a_1^3}$$

$$c_5 = \frac{-a_5}{a_1} + \frac{6a_2 a_4}{a_1^2} + \frac{3a_3^2}{a_1^2} - \frac{21a_2^2 a_3}{a_1^3} + \frac{14a_2^4}{a_1^4}$$

**Inversion of Newton's Forward Difference Formula**

25.2.63

$$a_0 = f_0$$

$$a_1 = \Delta_0 - \frac{\Delta_0^2}{2} + \frac{\Delta_0^3}{3} - \frac{\Delta_0^4}{4} + \dots$$

$$a_2 = \frac{\Delta_0^2}{2} - \frac{\Delta_0^3}{2} + \frac{11\Delta_0^4}{24} + \dots$$

$$a_3 = \frac{\Delta_0^3}{6} - \frac{\Delta_0^4}{4} + \dots$$

$$a_4 = \frac{\Delta_0^4}{24} + \dots$$

(Used in conjunction with 25.2.62.)

**Inversion of Everett's Formula**

25.2.64

$$a_0 = f_0$$

$$a_1 = \delta_1 - \frac{\delta_0^2}{3} + \frac{\delta_1^2}{6} + \frac{\delta_0^4}{20} + \frac{\delta_1^4}{30} + \dots$$

$$a_2 = \frac{\delta_0^2}{2} - \frac{\delta_0^4}{24} + \dots$$

$$a_3 = \frac{-\delta_0^2 + \delta_1^2}{6} - \frac{\delta_0^4 + \delta_1^4}{24} + \dots$$

$$a_4 = \frac{\delta_0^4}{24} + \dots$$

$$a_5 = \frac{-\delta_0^4 + \delta_1^4}{120} + \dots$$

(Used in conjunction with 25.2.62.)

**Bivariate Interpolation****Three Point Formula (Linear)**

25.2.65

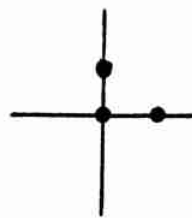

$$f(x_0 + ph, y_0 + qk) = (1-p-q)f_{0,0} + pf_{1,0} + qf_{0,1} + O(h^2)$$

**Four Point Formula**

25.2.66

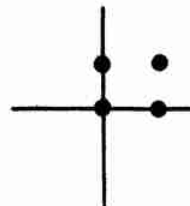

$$f(x_0 + ph, y_0 + qk) = (1-p)(1-q)f_{0,0} + p(1-q)f_{1,0} + q(1-p)f_{0,1} + pqf_{1,1} + O(h^2)$$

**Six Point Formula**

25.2.67

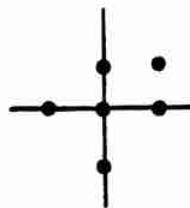

$$f(x_0 + ph, y_0 + qk) = \frac{q(q-1)}{2} f_{0,-1} + \frac{p(p-1)}{2} f_{-1,0} + (1+pq-p^2-q^2)f_{0,0} + \frac{p(p-2q+1)}{2} f_{1,0} + \frac{q(q-2p+1)}{2} f_{0,1} + pqf_{1,1} + O(h^3)$$

**25.3. Differentiation****Lagrange's Formula**

25.3.1 
$$f'(x) = \sum_{k=0}^n l'_k(x) f_k + R'_n(x)$$

(See 25.2.1.)

25.3.2 
$$l'_k(x) = \sum_{j \neq k} \frac{\pi_n(x)}{(x-x_k)(x-x_j)\pi'_n(x_k)}$$

25.3.3

$$R'_n(x) = \frac{f^{(n+1)}}{(n+1)!} (\xi) \pi'_n(x) + \frac{\pi_n(x)}{(n+1)!} \frac{d}{dx} f^{(n+1)}(\xi)$$

$$\xi = \xi(x) \quad (x_0 < \xi < x_n)$$

Equally Spaced Abscissas

Three Points

25.3.4

$$f'_p = f'(x_0 + ph)$$

$$= \frac{1}{h} \left\{ (p - \frac{1}{2})f_{-1} - 2pf_0 + (p + \frac{1}{2})f_1 \right\} + R'_2$$

Four Points

25.3.5

$$f'_p = f'(x_0 + ph) = \frac{1}{h} \left\{ -\frac{3p^2 - 6p + 2}{6} f_{-1} \right.$$

$$+ \frac{3p^2 - 4p - 1}{2} f_0 - \frac{3p^2 - 2p - 2}{2} f_1$$

$$\left. + \frac{3p^2 - 1}{6} f_2 \right\} + R'_3$$

Five Points

25.3.6

$$f'_p = f'(x_0 + ph) = \frac{1}{h} \left\{ \frac{2p^3 - 3p^2 - p + 1}{12} f_{-2} \right.$$

$$- \frac{4p^3 - 3p^2 - 8p + 4}{6} f_{-1} + \frac{2p^3 - 5p}{2} f_0$$

$$- \frac{4p^3 + 3p^2 - 8p - 4}{6} f_1$$

$$\left. + \frac{2p^3 + 3p^2 - p - 1}{12} f_2 \right\} + R'_4$$

For numerical values of differentiation coefficients see **Table 25.2**.

Markoff's Formulas

(Newton's Forward Difference Formula Differentiated)

25.3.7

$$f'(a_0 + ph) = \frac{1}{h} \left[ \Delta_0 + \frac{2p-1}{2} \Delta_0^2 \right.$$

$$\left. + \frac{3p^2 - 6p + 2}{6} \Delta_0^3 + \dots + \frac{d}{dp} \binom{p}{n} \Delta_0^n \right] + R'_n$$

25.3.8

$$R'_n = h^n f^{(n+1)}(\xi) \frac{d}{dp} \binom{p}{n+1} + h^{n+1} \binom{p}{n+1} \frac{d}{dx} f^{(n+1)}(\xi)$$

$$(a_0 < \xi < a_n)$$

25.3.9  $hf'_0 = \Delta_0 - \frac{1}{2} \Delta_0^2 + \frac{1}{3} \Delta_0^3 - \frac{1}{4} \Delta_0^4 + \dots$

25.3.10  $h^2 f''_0 = \Delta_0^2 - \Delta_0^3 + \frac{11}{12} \Delta_0^4 - \frac{5}{6} \Delta_0^5 + \dots$

25.3.11

$$h^3 f'''_0 = \Delta_0^3 - \frac{3}{2} \Delta_0^4 + \frac{7}{4} \Delta_0^5 - \frac{15}{8} \Delta_0^6 + \dots$$

25.3.12

$$h^4 f^{(4)}_0 = \Delta_0^4 - 2\Delta_0^5 + \frac{17}{6} \Delta_0^6 - \frac{7}{2} \Delta_0^7 + \dots$$

25.3.13

$$h^5 f^{(5)}_0 = \Delta_0^5 - \frac{5}{2} \Delta_0^6 + \frac{25}{6} \Delta_0^7 - \frac{35}{6} \Delta_0^8 + \dots$$

Everett's Formula

25.3.14

$$hf'(x_0 + ph) \approx -f_0 + f_1 - \frac{3p^2 - 6p + 2}{6} \delta_0^2 + \frac{3p^2 - 1}{6} \delta_1^2$$

$$- \frac{5p^4 - 20p^3 + 15p^2 + 10p - 6}{120} \delta_0^4 + \frac{5p^4 - 15p^2 + 4}{120} \delta_1^4$$

$$+ \dots - \left[ \binom{p+n-1}{2n+1} \right]' \delta_0^{2n} + \left[ \binom{p+n}{2n+1} \right]' \delta_1^{2n}$$

25.3.15

$$hf'_0 \approx -f_0 + f_1 - \frac{1}{3} \delta_0^2 - \frac{1}{6} \delta_1^2 + \frac{1}{20} \delta_0^4 + \frac{1}{30} \delta_1^4$$

Differences in Terms of Derivatives

25.3.16

$$\Delta_0 \approx hf'_0 + \frac{h^2}{2!} f''_0 + \frac{h^3}{3!} f'''_0 + \frac{h^4}{4!} f^{(4)}_0 + \frac{h^5}{5!} f^{(5)}_0$$

25.3.17

$$\Delta_0^2 \approx h^2 f''_0 + h^3 f'''_0 + \frac{7}{12} h^4 f^{(4)}_0 + \frac{1}{4} h^5 f^{(5)}_0$$

25.3.18

$$\Delta_0^3 \approx h^3 f'''_0 + \frac{3}{2} h^4 f^{(4)}_0 + \frac{5}{4} h^5 f^{(5)}_0$$

25.3.19

$$\Delta_0^4 \approx h^4 f^{(4)}_0 + 2h^5 f^{(5)}_0$$

25.3.20

$$\Delta_0^5 \approx h^5 f^{(5)}_0$$

Partial Derivatives

25.3.21

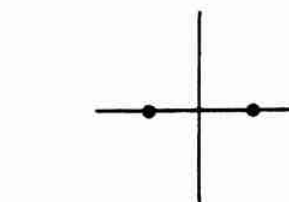

$$\frac{\partial f_{0,0}}{\partial x} = \frac{1}{2h} (f_{1,0} - f_{-1,0}) + O(h^2)$$



25.3.22

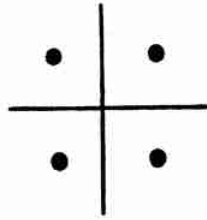

$$\frac{\partial f_{0,0}}{\partial x} = \frac{1}{4h} (f_{1,1} - f_{-1,1} + f_{1,-1} - f_{-1,-1}) + O(h^2)$$

25.3.23

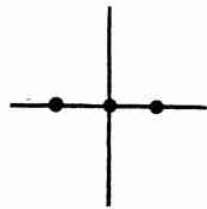

$$\frac{\partial^2 f_{0,0}}{\partial x^2} = \frac{1}{h^2} (f_{1,0} - 2f_{0,0} + f_{-1,0}) + O(h^2)$$

25.3.24

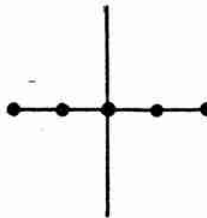

$$\frac{\partial^2 f_{0,0}}{\partial x^2} = \frac{1}{12h^2} (-f_{2,0} + 16f_{1,0} - 30f_{0,0} + 16f_{-1,0} - f_{-2,0}) + O(h^4)$$

25.3.25

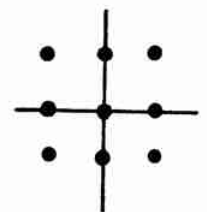

$$\frac{\partial^2 f_{0,0}}{\partial x^2} = \frac{1}{3h^2} (f_{1,1} - 2f_{0,1} + f_{-1,1} + f_{1,0} - 2f_{0,0} + f_{-1,0} + f_{1,-1} - 2f_{0,-1} + f_{-1,-1}) + O(h^2)$$

25.3.26

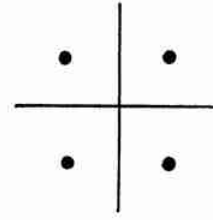

$$\frac{\partial^2 f_{0,0}}{\partial x \partial y} = \frac{1}{4h^2} (f_{1,1} - f_{1,-1} - f_{-1,1} + f_{-1,-1}) + O(h^2)$$

25.3.27

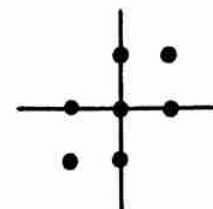

$$\frac{\partial^2 f_{0,0}}{\partial x \partial y} = \frac{-1}{2h^2} (f_{1,0} + f_{-1,0} + f_{0,1} + f_{0,-1} - 2f_{0,0} - f_{1,1} - f_{-1,-1}) + O(h^2)$$

25.3.28

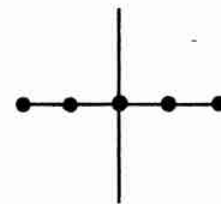

$$\frac{\partial^4 f_{0,0}}{\partial x^4} = \frac{1}{h^4} (f_{2,0} - 4f_{1,0} + 6f_{0,0} - 4f_{-1,0} + f_{-2,0}) + O(h^2)$$

25.3.29

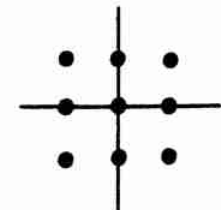

$$\frac{\partial^4 f_{0,0}}{\partial x^2 \partial y^2} = \frac{1}{h^4} (f_{1,1} + f_{-1,1} + f_{1,-1} + f_{-1,-1} - 2f_{1,0} - 2f_{-1,0} - 2f_{0,1} - 2f_{0,-1} + 4f_{0,0}) + O(h^2)$$

**Laplacian**

25.3.30

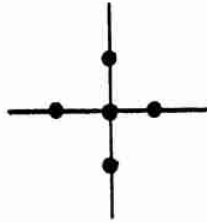

$$\begin{aligned} \nabla^2 u_{0,0} &= \left( \frac{\partial^2 u}{\partial x^2} + \frac{\partial^2 u}{\partial y^2} \right)_{0,0} \\ &= \frac{1}{h^2} (u_{1,0} + u_{0,1} + u_{-1,0} + u_{0,-1} - 4u_{0,0}) + O(h^2) \end{aligned}$$

25.3.31

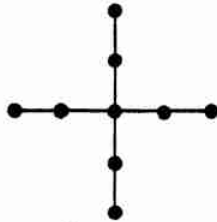

$$\begin{aligned} \nabla^2 u_{0,0} &= \frac{1}{12h^2} [-60u_{0,0} + 16(u_{1,0} + u_{0,1} + u_{-1,0} + u_{0,-1}) \\ &\quad - (u_{2,0} + u_{0,2} + u_{-2,0} + u_{0,-2})] + O(h^4) \end{aligned}$$

**Biharmonic Operator**

25.3.32

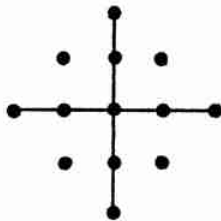

$$\begin{aligned} \nabla^4 u_{0,0} &= \left( \frac{\partial^4 u}{\partial x^4} + 2 \frac{\partial^4 u}{\partial x^2 \partial y^2} + \frac{\partial^4 u}{\partial y^4} \right)_{0,0} \\ &= \frac{1}{h^4} [20u_{0,0} - 8(u_{1,0} + u_{0,1} + u_{-1,0} + u_{0,-1}) \\ &\quad + 2(u_{1,1} + u_{1,-1} + u_{-1,1} + u_{-1,-1}) \\ &\quad + (u_{0,2} + u_{2,0} + u_{-2,0} + u_{0,-2})] + O(h^2) \end{aligned}$$

25.3.33

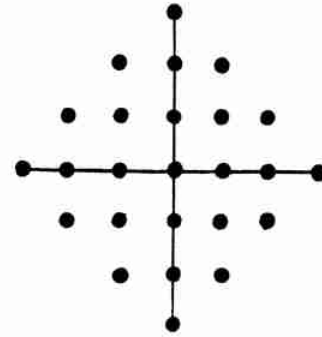

$$\begin{aligned} \nabla^4 u_{0,0} &= \frac{1}{6h^4} [-(u_{0,3} + u_{0,-3} + u_{3,0} + u_{-3,0}) \\ &\quad + 14(u_{0,2} + u_{0,-2} + u_{2,0} + u_{-2,0}) \\ &\quad - 77(u_{0,1} + u_{0,-1} + u_{1,0} + u_{-1,0}) \\ &\quad + 184u_{0,0} + 20(u_{1,1} + u_{1,-1} + u_{-1,1} + u_{-1,-1}) \\ &\quad - (u_{1,2} + u_{2,1} + u_{1,-2} + u_{2,-1} + u_{-1,2} + u_{-2,1} \\ &\quad \quad + u_{-1,-2} + u_{-2,-1})] + O(h^4) \end{aligned}$$

**25.4. Integration**

**Trapezoidal Rule**

25.4.1

$$\begin{aligned} \int_{x_0}^{x_1} f(x) dx &= \frac{h}{2} (f_0 + f_1) - \frac{1}{2} \int_{x_0}^{x_1} (t-x_0)(x_1-t) f''(t) dt \\ &= \frac{h}{2} (f_0 + f_1) - \frac{h^3}{12} f''(\xi) \quad (x_0 < \xi < x_1) \end{aligned}$$

**Extended Trapezoidal Rule**

25.4.2

$$\begin{aligned} \int_{x_0}^{x_m} f(x) dx &= h \left[ \frac{f_0}{2} + f_1 + \dots + f_{m-1} + \frac{f_m}{2} \right] \\ &\quad - \frac{mh^3}{12} f''(\xi) \end{aligned}$$

**Error Term in Trapezoidal Formula for Periodic Functions**

If  $f(x)$  is periodic and has a continuous  $k^{\text{th}}$  derivative, and if the integral is taken over a period, then

25.4.3  $|\text{Error}| \leq \frac{\text{constant}}{m^k}$

**Modified Trapezoidal Rule**

25.4.4

$$\begin{aligned} \int_{x_0}^{x_m} f(x) dx &= h \left[ \frac{f_0}{2} + f_1 + \dots + f_{m-1} + \frac{f_m}{2} \right] \\ &\quad + \frac{h}{24} [-f_{-1} + f_1 + f_{m-1} - f_{m+1}] + \frac{11m}{720} h^5 f^{(4)}(\xi) \end{aligned}$$

**Simpson's Rule**

25.4.5

$$\int_{x_0}^{x_2} f(x)dx = \frac{h}{3} [f_0 + 4f_1 + f_2] + \frac{1}{6} \int_{x_0}^{x_1} (x_0 - t)^2 (x_1 - t) f^{(3)}(t) dt + \frac{1}{6} \int_{x_1}^{x_2} (x_2 - t)^2 (x_1 - t) f^{(3)}(t) dt = \frac{h}{3} [f_0 + 4f_1 + f_2] - \frac{h^5}{90} f^{(4)}(\xi)$$

**Extended Simpson's Rule**

25.4.6

$$\int_{x_0}^{x_{2n}} f(x)dx = \frac{h}{3} [f_0 + 4(f_1 + f_3 + \dots + f_{2n-1}) + 2(f_2 + f_4 + \dots + f_{2n-2}) + f_{2n}] - \frac{nh^5}{90} f^{(4)}(\xi)$$

**Euler-Maclaurin Summation Formula**

25.4.7

$$\int_{x_0}^{x_n} f(x)dx = h \left[ \frac{f_0}{2} + f_1 + f_2 + \dots + f_{n-1} + \frac{f_n}{2} \right] - \frac{B_2}{2!} h^2 (f'_n - f'_0) - \dots - \frac{B_{2k} h^{2k}}{(2k)!} [f^{(2k-1)}_n - f^{(2k-1)}_0] + R_{2k}$$

$$R_{2k} = \frac{\theta n B_{2k+2} h^{2k+3}}{(2k+2)!} \max_{x_0 \leq x \leq x_n} |f^{(2k+2)}(x)|, \quad (-1 \leq \theta \leq 1)$$

(For  $B_{2k}$ , Bernoulli numbers, see chapter 23.)

If  $f^{(2k+2)}(x)$  and  $f^{(2k+4)}(x)$  do not change sign for  $x_0 < x < x_n$  then  $|R_{2k}|$  is less than the first neglected term. If  $f^{(2k+2)}(x)$  does not change sign for  $x_0 < x < x_n$ ,  $|R_{2k}|$  is less than twice the first neglected term.

**Lagrange Formula**

25.4.8

$$\int_a^b f(x)dx = \sum_{i=0}^n (L_i^{(n)}(b) - L_i^{(n)}(a)) f_i + R_n$$

(See 25.2.1.)

25.4.9

$$L_i^{(n)}(x) = \frac{1}{\pi'_n(x_i)} \int_{x_0}^x \frac{\pi_n(t)}{t - x_i} dt = \int_{x_0}^x l_i(t) dt$$

25.4.10  $R_n = \frac{1}{(n+1)!} \int_a^b \pi_n(x) f^{(n+1)}(\xi(x)) dx$

**Equally Spaced Abscissas**

25.4.11

$$\int_{x_0}^{x_k} f(x)dx = \frac{1}{h^n} \sum_{i=0}^n f_i \frac{(-1)^{n-i}}{i!(n-i)!} \int_{x_0}^{x_k} \frac{\pi_n(x)}{x - x_i} dx + R_n$$

25.4.12  $\int_{x_m}^{x_{m+1}} f(x)dx = h \sum_{i=-\lfloor \frac{n-1}{2} \rfloor}^{\lfloor \frac{n}{2} \rfloor} A_i(m) f_i + R_n$  \*

(See Table 25.3 for  $A_i(m)$ .)

**Newton-Cotes Formulas (Closed Type)**

(For Trapezoidal and Simpson's Rules see 25.4.1-25.4.6.)

25.4.13 (Simpson's  $\frac{3}{8}$  rule)

$$\int_{x_0}^{x_3} f(x)dx = \frac{3h}{8} (f_0 + 3f_1 + 3f_2 + f_3) - \frac{3f^{(4)}(\xi)h^5}{80}$$

25.4.14 (Bode's rule)

$$\int_{x_0}^{x_4} f(x)dx = \frac{2h}{45} (7f_0 + 32f_1 + 12f_2 + 32f_3 + 7f_4) - \frac{8f^{(6)}(\xi)h^7}{945}$$

25.4.15

$$\int_{x_0}^{x_5} f(x)dx = \frac{5h}{288} (19f_0 + 75f_1 + 50f_2 + 50f_3 + 75f_4 + 19f_5) - \frac{275f^{(6)}(\xi)h^7}{12096}$$

25.4.16

$$\int_{x_0}^{x_6} f(x)dx = \frac{h}{140} (41f_0 + 216f_1 + 27f_2 + 272f_3 + 27f_4 + 216f_5 + 41f_6) - \frac{9f^{(8)}(\xi)h^9}{1400}$$

25.4.17

$$\int_{x_0}^{x_7} f(x)dx = \frac{7h}{17280} (751f_0 + 3577f_1 + 1323f_2 + 2989f_3 + 2989f_4 + 1323f_5 + 3577f_6 + 751f_7) - \frac{8183f^{(8)}(\xi)h^9}{518400}$$

25.4.18

$$\int_{x_0}^{x_8} f(x)dx = \frac{4h}{14175} (989f_0 + 5888f_1 - 928f_2 + 10496f_3 - 4540f_4 + 10496f_5 - 928f_6 + 5888f_7 + 989f_8) - \frac{2368}{467775} f^{(10)}(\xi)h^{11}$$

25.4.19

$$\int_{x_0}^{x_9} f(x)dx = \frac{9h}{89600} \{ 2857(f_0 + f_9) + 15741(f_1 + f_8) + 1080(f_2 + f_7) + 19344(f_3 + f_6) + 5778(f_4 + f_5) \} - \frac{173}{14620} f^{(10)}(\xi)h^{11}$$

\*See page II.

25.4.20

$$\int_{x_0}^{x_{10}} f(x) dx = \frac{5h}{299376} \{16067(f_0 + f_{10}) + 106300(f_1 + f_9) - 48525(f_2 + f_8) + 272400(f_3 + f_7) - 260550(f_4 + f_6) + 427368f_5\} - \frac{1346350}{326918592} f^{(12)}(\xi) h^{13}$$

Newton-Cotes Formulas (Open Type)

25.4.21

$$\int_{x_0}^{x_3} f(x) dx = \frac{3h}{2} (f_1 + f_2) + \frac{f^{(2)}(\xi) h^3}{4}$$

25.4.22

$$\int_{x_0}^{x_4} f(x) dx = \frac{4h}{3} (2f_1 - f_2 + 2f_3) + \frac{28f^{(4)}(\xi) h^5}{90}$$

25.4.23

$$\int_{x_0}^{x_5} f(x) dx = \frac{5h}{24} (11f_1 + f_2 + f_3 + 11f_4) + \frac{95f^{(4)}(\xi) h^5}{144}$$

25.4.24

$$\int_{x_0}^{x_6} f(x) dx = \frac{6h}{20} (11f_1 - 14f_2 + 26f_3 - 14f_4 + 11f_5) + \frac{41f^{(6)}(\xi) h^7}{140}$$

25.4.25

$$\int_{x_0}^{x_7} f(x) dx = \frac{7h}{1440} (611f_1 - 453f_2 + 562f_3 + 562f_4 - 453f_5 + 611f_6) + \frac{5257}{8640} f^{(6)}(\xi) h^7$$

25.4.26

$$\int_{x_0}^{x_8} f(x) dx = \frac{8h}{945} (460f_1 - 954f_2 + 2196f_3 - 2459f_4 + 2196f_5 - 954f_6 + 460f_7) + \frac{3956}{14175} f^{(8)}(\xi) h^9$$

Five Point Rule for Analytic Functions

25.4.27

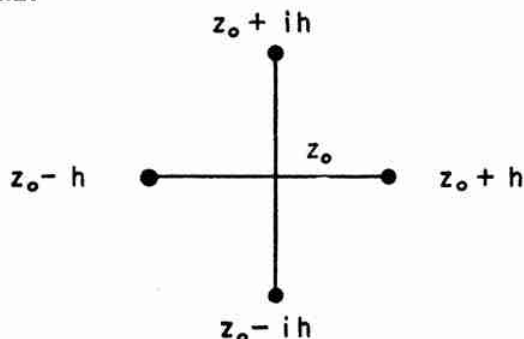

$$\int_{z_0-h}^{z_0+h} f(z) dz = \frac{h}{15} \{24f(z_0) + 4[f(z_0+h) + f(z_0-h)] - [f(z_0+ih) + f(z_0-ih)]\} + R$$

$|R| \leq \frac{|h|^7}{1890} \text{Max}_{z \in S} |f^{(6)}(z)|$ ,  $S$  designates the square with vertices  $z_0 + i^k h$  ( $k=0, 1, 2, 3$ );  $h$  can be complex.

Chebyshev's Equal Weight Integration Formula

25.4.28 
$$\int_{-1}^1 f(x) dx = \frac{2}{n} \sum_{i=1}^n f(x_i) + R_n$$

Abscissas:  $x_i$  is the  $i^{\text{th}}$  zero of the polynomial part of

$$x^n \exp \left[ \frac{-n}{2 \cdot 3x^2} - \frac{n}{4 \cdot 5x^3} - \frac{n}{6 \cdot 7x^4} - \dots \right]$$

(See Table 25.5 for  $x_i$ .)

For  $n=8$  and  $n \geq 10$  some of the zeros are complex.

Remainder:

$$R_n = \int_{-1}^{+1} \frac{x^{n+1}}{(n+1)!} f^{(n+1)}(\xi) dx - \frac{2}{n(n+1)!} \sum_{i=1}^n x_i^{n+1} f^{(n+1)}(\xi_i)$$

where  $\xi = \xi(x)$  satisfies  $0 \leq \xi \leq x$  and  $0 \leq \xi_i \leq x_i$

$$(i=1, \dots, n)$$

Integration Formulas of Gaussian Type

(For Orthogonal Polynomials see chapter 22)

Gauss' Formula

25.4.29 
$$\int_{-1}^1 f(x) dx = \sum_{i=1}^n w_i f(x_i) + R_n$$

Related orthogonal polynomials: Legendre polynomials  $P_n(x)$ ,  $P_n(1) = 1$

Abscissas:  $x_i$  is the  $i^{\text{th}}$  zero of  $P_n(x)$

Weights:  $w_i = 2/(1-x_i^2) [P_n'(x_i)]^2$

(See Table 25.4 for  $x_i$  and  $w_i$ .)

$$R_n = \frac{2^{2n+1} (n!)^4}{(2n+1) [(2n)!]^3} f^{(2n)}(\xi) \quad (-1 < \xi < 1)$$

Gauss' Formula, Arbitrary Interval

25.4.30 
$$\int_a^b f(y) dy = \frac{b-a}{2} \sum_{i=1}^n w_i f(y_i) + R_n$$

$$y_i = \left(\frac{b-a}{2}\right) x_i + \left(\frac{b+a}{2}\right)$$

\*See page II.

Related orthogonal polynomials:  $P_n(x)$ ,  $P_n(1)=1$

Abscissas:  $x_i$  is the  $i^{\text{th}}$  zero of  $P_n(x)$

\* Weights:  $w_i=2/(1-x_i^2) [P'_n(x_i)]^2$

$$* R_n = \frac{(b-a)^{2n+1} (n!)^4}{(2n+1) [(2n)!]^3} f^{(2n)}(\xi)$$

#### Radau's Integration Formula

25.4.31

$$\int_{-1}^1 f(x) dx = \frac{2}{n^2} f_{-1} + \sum_{i=1}^{n-1} w_i f(x_i) + R_n$$

Related polynomials:

$$\frac{P_{n-1}(x) + P_n(x)}{x+1}$$

Abscissas:  $x_i$  is the  $i^{\text{th}}$  zero of

$$\frac{P_{n-1}(x) + P_n(x)}{x+1}$$

Weights:

$$w_i = \frac{1}{n^2} \frac{1-x_i}{[P_{n-1}(x_i)]^2} = \frac{1}{1-x_i} \frac{1}{[P'_{n-1}(x_i)]^2}$$

Remainder:

$$R_n = \frac{2^{2n-1} \cdot n}{[(2n-1)!]^3} [(n-1)!]^4 f^{(2n-1)}(\xi) \quad (-1 < \xi < 1)$$

#### Lobatto's Integration Formula

25.4.32

$$\int_{-1}^1 f(x) dx = \frac{2}{n(n-1)} [f(1) + f(-1)] + \sum_{i=2}^{n-1} w_i f(x_i) + R_n$$

Related polynomials:  $P'_{n-1}(x)$

Abscissas:  $x_i$  is the  $(i-1)^{\text{st}}$  zero of  $P'_{n-1}(x)$

Weights:

$$w_i = \frac{2}{n(n-1) [P'_{n-1}(x_i)]^2} \quad (x_i \neq \pm 1)$$

(See Table 25.6 for  $x_i$  and  $w_i$ .)

Remainder:

$$R_n = \frac{-n(n-1)^3 2^{2n-1} [(n-2)!]^4}{(2n-1) [(2n-2)!]^3} f^{(2n-2)}(\xi) \quad (-1 < \xi < 1)$$

\*See page II.

$$25.4.33 \quad \int_0^1 x^k f(x) dx = \sum_{i=1}^n w_i f(x_i) + R_n$$

Related orthogonal polynomials:

$$q_n(x) = \sqrt{k+2n+1} P_n^{(k,0)}(1-2x)$$

(For the Jacobi polynomials  $P_n^{(k,0)}$  see chapter 22.)

Abscissas:

$x_i$  is the  $i^{\text{th}}$  zero of  $q_n(x)$

Weights:

$$w_i = \left\{ \sum_{j=0}^{n-1} [q_j(x_i)]^2 \right\}^{-1}$$

(See Table 25.8 for  $x_i$  and  $w_i$ .)

Remainder:

$$R_n = \frac{f^{(2n)}(\xi)}{(k+2n+1)(2n)!} \left[ \frac{n!(k+n)!}{(k+2n)!} \right]^2 \quad (0 < \xi < 1)$$

25.4.34

$$\int_0^1 f(x) \sqrt{1-x} dx = \sum_{i=1}^n w_i f(x_i) + R_n$$

Related orthogonal polynomials:

$$\frac{1}{\sqrt{1-x}} P_{2n+1}(\sqrt{1-x}), P_{2n+1}(1)=1$$

Abscissas:  $x_i = 1 - \xi_i^2$  where  $\xi_i$  is the  $i^{\text{th}}$  positive zero of  $P_{2n+1}(x)$ .

Weights:  $w_i = 2\xi_i^2 w_i^{(2n+1)}$  where  $w_i^{(2n+1)}$  are the Gaussian weights of order  $2n+1$ .

Remainder:

$$R_n = \frac{2^{4n+3} [(2n+1)!]^4}{(2n)!(4n+3) [(4n+2)!]^2} f^{(2n)}(\xi) \quad (0 < \xi < 1)$$

25.4.35

$$\int_a^b f(y) \sqrt{b-y} dy = (b-a)^{3/2} \sum_{i=1}^n w_i f(y_i)$$

$$y_i = a + (b-a)x_i$$

Related orthogonal polynomials:

$$\frac{1}{\sqrt{1-x}} P_{2n+1}(\sqrt{1-x}), P_{2n+1}(1)=1$$

Abscissas:  $x_i = 1 - \xi_i^2$  where  $\xi_i$  is the  $i^{\text{th}}$  positive zero of  $P_{2n+1}(x)$ .

Weights:  $w_i = 2\xi_i^2 w_i^{(2n+1)}$  where  $w_i^{(2n+1)}$  are the Gaussian weights of order  $2n+1$ .

25.4.36  $\int_0^1 \frac{f(x)}{\sqrt{1-x}} dx = \sum_{i=1}^n w_i f(x_i) + R_n$

Related orthogonal polynomials:

$$P_{2n}(\sqrt{1-x}), P_{2n}(1)=1$$

Abscissas:  $x_i=1-\xi_i^2$  where  $\xi_i$  is the  $i^{\text{th}}$  positive zero of  $P_{2n}(x)$ .

Weights:  $w_i=2w_i^{(2n)}$ ,  $w_i^{(2n)}$  are the Gaussian weights of order  $2n$ .

Remainder:

$$R_n = \frac{2^{4n+1}}{4n+1} \frac{[(2n)!]^3}{[(4n)!]^2} f^{(2n)}(\xi) \quad (0 < \xi < 1)$$

25.4.37  $\int_a^b \frac{f(y)}{\sqrt{b-y}} dy = \sqrt{b-a} \sum_{i=1}^n w_i f(y_i) + R_n$   
 $y_i = a + (b-a)x_i$

Related orthogonal polynomials:

$$P_{2n}(\sqrt{1-x}), P_{2n}(1)=1$$

Abscissas:

$x_i=1-\xi_i^2$  where  $\xi_i$  is the  $i^{\text{th}}$  positive zero of  $P_{2n}(x)$ .

Weights:  $w_i=2w_i^{(2n)}$ ,  $w_i^{(2n)}$  are the Gaussian weights of order  $2n$ .

25.4.38  $\int_{-1}^{+1} \frac{f(x)}{\sqrt{1-x^2}} dx = \sum_{i=1}^n w_i f(x_i) + R_n$

Related orthogonal polynomials: Chebyshev Polynomials of First Kind

$$T_n(x), T_n(1) = \frac{1}{2^{n-1}}$$

Abscissas:

$$x_i = \cos \frac{(2i-1)\pi}{2n}$$

Weights:

$$w_i = \frac{\pi}{n}$$

Remainder:

$$R_n = \frac{\pi}{(2n)! 2^{2n-1}} f^{(2n)}(\xi) \quad (-1 < \xi < 1)$$

25.4.39

$$\int_a^b \frac{f(y)dy}{\sqrt{(y-a)(b-y)}} = \sum_{i=1}^n w_i f(y_i) + R_n$$

$$y_i = \frac{b+a}{2} + \frac{b-a}{2} x_i$$

Related orthogonal polynomials:

$$T_n(x), T_n(1) = \frac{1}{2^{n-1}}$$

Abscissas:

$$x_i = \cos \frac{(2i-1)\pi}{2n}$$

Weights:

$$w_i = \frac{\pi}{n}$$

25.4.40

$$\int_{-1}^{+1} f(x) \sqrt{1-x^2} dx = \sum_{i=1}^n w_i f(x_i) + R_n$$

Related orthogonal polynomials: Chebyshev Polynomials of Second Kind

$$U_n(x) = \frac{\sin [(n+1) \arccos x]}{\sin (\arccos x)} \quad *$$

Abscissas:

$$x_i = \cos \frac{i}{n+1} \pi \quad *$$

Weights:

$$w_i = \frac{\pi}{n+1} \sin^2 \frac{i}{n+1} \pi \quad *$$

Remainder:

$$R_n = \frac{\pi}{(2n)! 2^{2n+1}} f^{(2n)}(\xi) \quad (-1 < \xi < 1)$$

25.4.41

$$\int_a^b \sqrt{(y-a)(b-y)} f(y) dy = \left(\frac{b-a}{2}\right)^2 \sum_{i=1}^n w_i f(y_i) + R_n$$

$$y_i = \frac{b+a}{2} + \frac{b-a}{2} x_i$$

Related orthogonal polynomials:

$$U_n(x) = \frac{\sin [(n+1) \arccos x]}{\sin (\arccos x)} \quad *$$

Abscissas:

$$x_i = \cos \frac{i}{n+1} \pi \quad *$$

Weights:

$$w_i = \frac{\pi}{n+1} \sin^2 \frac{i}{n+1} \pi \quad *$$

25.4.42  $\int_0^1 f(x) \sqrt{\frac{x}{1-x}} dx = \sum_{i=1}^n w_i f(x_i) + R_n$

Related orthogonal polynomials:

$$\frac{1}{\sqrt{x}} T_{2n+1}(\sqrt{x})$$

Abscissas:

$$x_i = \cos^2 \frac{2i-1}{2n+1} \cdot \frac{\pi}{2}$$

Weights:

$$w_i = \frac{2\pi}{2n+1} x_i$$

Remainder:

$$R_n = \frac{\pi}{(2n)! 2^{2n+1}} f^{(2n)}(\xi) \quad (0 < \xi < 1)$$

**25.4.43**

$$\int_a^b f(x) \sqrt{\frac{x-a}{b-x}} dx = (b-a) \sum_{i=1}^n w_i f(y_i) + R_n$$

$$y_i = a + (b-a)x_i$$

Related orthogonal polynomials:

$$\frac{1}{\sqrt{x}} T_{2n+1}(\sqrt{x})$$

Abscissas:

$$x_i = \cos^2 \frac{2i-1}{2n+1} \cdot \frac{\pi}{2}$$

Weights:

$$w_i = \frac{2\pi}{2n+1} x_i$$

**25.4.44**  $\int_0^1 \ln x f(x) dx = \sum_{i=1}^n w_i f(x_i) + R_n$

Related orthogonal polynomials: polynomials orthogonal with respect to the weight function  $-\ln x$

Abscissas: See **Table 25.7**

Weights: See **Table 25.7**

**25.4.45**

$$\int_0^\infty e^{-x} f(x) dx = \sum_{i=1}^n w_i f(x_i) + R_n$$

Related orthogonal polynomials: Laguerre polynomials  $L_n(x)$ .

Abscissas:  $x_i$  is the  $i^{\text{th}}$  zero of  $L_n(x)$

Weights:

\* 
$$w_i = \frac{x_i}{(n+1)^2 [L_{n+1}(x_i)]^2}$$

(See **Table 25.9** for  $x_i$  and  $w_i$ .)

Remainder:

$$R_n = \frac{(n!)^2}{(2n)!} f^{(2n)}(\xi) \quad (0 < \xi < \infty)$$

**25.4.46**

$$\int_{-\infty}^\infty e^{-x^2} f(x) dx = \sum_{i=1}^n w_i f(x_i) + R_n$$

Related orthogonal polynomials: Hermite polynomials  $H_n(x)$ .

Abscissas:  $x_i$  is the  $i^{\text{th}}$  zero of  $H_n(x)$

Weights:

$$\frac{2^{n-1} n! \sqrt{\pi}}{n^2 [H_{n-1}(x_i)]^2}$$

(See **Table 25.10** for  $x_i$  and  $w_i$ .)

\*See page 11.

Remainder:

$$R_n = \frac{n! \sqrt{\pi}}{2^n (2n)!} f^{(2n)}(\xi) \quad (-\infty < \xi < \infty)$$

**Filon's Integration Formula<sup>3</sup>**

**25.4.47**

$$\int_{x_0}^{x_m} f(x) \cos tx dx = h \left[ \alpha(th) (f_{2n} \sin tx_{2n} - f_0 \sin tx_0) + \beta(th) \cdot C_{2n} + \gamma(th) \cdot C_{2n-1} + \frac{2}{45} th^4 S'_{2n-1} \right] - R_n$$

**25.4.48**

$$C_{2n} = \sum_{i=0}^n f_{2i} \cos (tx_{2i}) - \frac{1}{2} [f_{2n} \cos tx_{2n} + f_0 \cos tx_0]$$

**25.4.49**

$$C_{2n-1} = \sum_{i=1}^n f_{2i-1} \cos tx_{2i-1}$$

**25.4.50**

$$S'_{2n-1} = \sum_{i=1}^n f_{2i-1}^{(3)} \sin tx_{2i-1}$$

**25.4.51**

$$R_n = \frac{1}{90} nh^5 f^{(4)}(\xi) + O(th^7)$$

**25.4.52**

$$\alpha(\theta) = \frac{1}{\theta} + \frac{\sin 2\theta}{2\theta^2} - \frac{2 \sin^2 \theta}{\theta^3}$$

$$\beta(\theta) = 2 \left( \frac{1 + \cos^2 \theta}{\theta^2} - \frac{\sin 2\theta}{\theta^3} \right)$$

$$\gamma(\theta) = 4 \left( \frac{\sin \theta}{\theta^3} - \frac{\cos \theta}{\theta^2} \right)$$

For small  $\theta$  we have

**25.4.53**

$$\alpha = \frac{2\theta^3}{45} - \frac{2\theta^5}{315} + \frac{2\theta^7}{4725} - \dots$$

$$\beta = \frac{2}{3} + \frac{2\theta^2}{15} - \frac{4\theta^4}{105} + \frac{2\theta^6}{567} - \dots$$

$$\gamma = \frac{4}{3} - \frac{2\theta^2}{15} + \frac{\theta^4}{210} - \frac{\theta^6}{11340} + \dots$$

**25.4.54**

$$\int_{x_0}^{x_{2n}} f(x) \sin tx dx = h \left[ \alpha(th) (f_0 \cos tx_0 - f_{2n} \cos tx_{2n}) + \beta S_{2n} + \gamma S_{2n-1} + \frac{2}{45} th^4 C'_{2n-1} \right] - R_n$$

**25.4.55**

$$S_{2n} = \sum_{i=0}^n f_{2i} \sin (tx_{2i}) - \frac{1}{2} [f_{2n} \sin (tx_{2n}) + f_0 \sin (tx_0)]$$

<sup>3</sup> For certain difficulties associated with this formula, see the article by J. W. Tukey, p. 400, "On Numerical Approximation," Ed. R. E. Langer, Madison, 1959.



25.4.56  $S_{2n-1} = \sum_{i=1}^n f_{2i-1} \sin(tx_{2i-1})$

25.4.57  $C'_{2n-1} = \sum_{i=1}^n f_{2i-1}^{(3)} \cos(tx_{2i-1})$

(See Table 25.11 for  $\alpha, \beta, \gamma$ .)

**Iterated Integrals**

25.4.58

$$\int_0^x dt_n \int_0^{t_n} dt_{n-1} \dots \int_0^{t_3} dt_2 \int_0^{t_2} f(t_1) dt_1 = \frac{1}{(n-1)!} \int_0^x (x-t)^{n-1} f(t) dt$$

25.4.59

$$\int_a^x dt_n \int_a^{t_n} dt_{n-1} \dots \int_a^{t_3} dt_2 \int_a^{t_2} f(t_1) dt_1 = \frac{(x-a)^n}{(n-1)!} \int_0^1 t^{n-1} f(x-(x-a)t) dt$$

**Multidimensional Integration**

Circumference of Circle  $\Gamma: x^2 + y^2 = h^2$ .

25.4.60

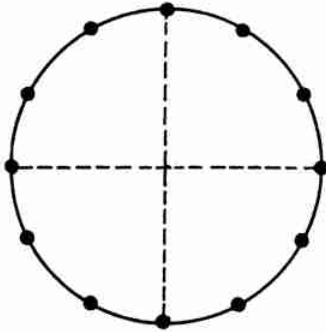

$$\frac{1}{2\pi h} \int_{\Gamma} f(x,y) ds = \frac{1}{2m} \sum_{n=1}^{2m} f\left(h \cos \frac{\pi n}{m}, h \sin \frac{\pi n}{m}\right) + O(h^{2m-2})$$

Circle  $C: x^2 + y^2 \leq h^2$ .

25.4.61

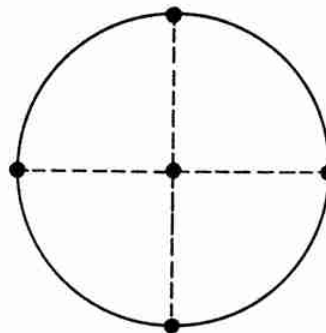

$$\frac{1}{\pi h^2} \iint_C f(x,y) dx dy = \sum_{i=1}^n w_i f(x_i, y_i) + R$$

|                          |       |              |
|--------------------------|-------|--------------|
| $(x_i, y_i)$             | $w_i$ |              |
| $(0, 0)$                 | $1/2$ | $R = O(h^4)$ |
| $(\pm h, 0), (0, \pm h)$ | $1/8$ |              |

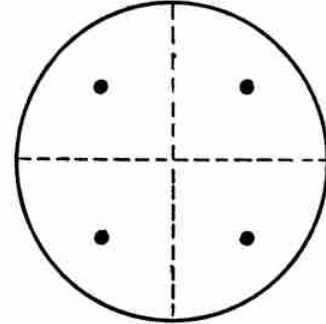

|                                      |       |              |
|--------------------------------------|-------|--------------|
| $(x_i, y_i)$                         | $w_i$ |              |
| $(\pm \frac{h}{2}, \pm \frac{h}{2})$ | $1/4$ | $R = O(h^4)$ |

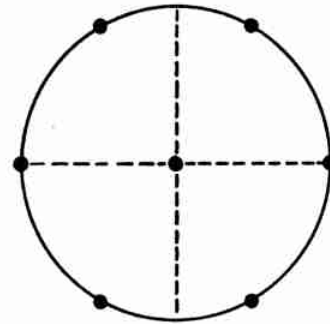

|   |        |              |
|---|--------|--------------|
| $(x_i, y_i)$                                  | $w_i$  |              |
| $(0, 0)$                                      | $1/2$  |              |
| $(\pm h, 0)$                                  | $1/12$ | $R = O(h^4)$ |
| $(\pm \frac{h}{2}, \pm \frac{h}{2} \sqrt{3})$ | $1/12$ |              |

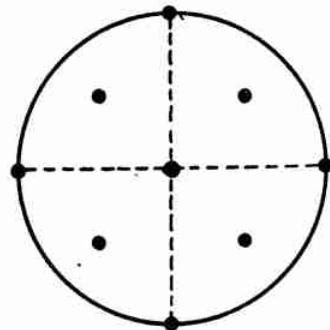

|                                      |        |              |
|--------------------------------------|--------|--------------|
| $(x_i, y_i)$                         | $w_i$  |              |
| $(0, 0)$                             | $1/6$  |              |
| $(\pm h, 0)$                         | $1/24$ | $R = O(h^6)$ |
| $(0, \pm h)$                         | $1/24$ |              |
| $(\pm \frac{h}{2}, \pm \frac{h}{2})$ | $1/6$  |              |

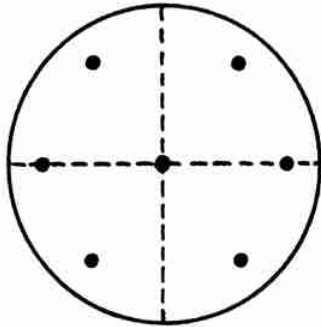

|  |       |              |
|--|-------|--------------|
| $(x_i, y_i)$   | $w_i$ |              |
| $(0, 0)$   | $1/4$ |              |
| $(\pm \sqrt{\frac{2}{3}}h, 0)$                       | $1/8$ | $R = O(h^6)$ |
| $(\pm \sqrt{\frac{1}{6}}h, \pm \frac{h}{2}\sqrt{2})$ | $1/8$ |              |

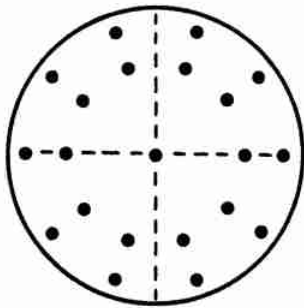

|  |                           |                    |
|--|---------------------------|--------------------|
| $(x_i, y_i)$   | $w_i$                     |                    |
| $(0, 0)$   | $1/9$                     |                    |
| $(\sqrt{\frac{6-\sqrt{6}}{10}}h \cos \frac{2\pi k}{10}, \sqrt{\frac{6-\sqrt{6}}{10}}h \sin \frac{2\pi k}{10})$ | $\frac{16+\sqrt{6}}{360}$ |                    |
|  |                           | $(k=1, \dots, 10)$ |
| $(\sqrt{\frac{6+\sqrt{6}}{10}}h \cos \frac{2\pi k}{10}, \sqrt{\frac{6+\sqrt{6}}{10}}h \sin \frac{2\pi k}{10})$ | $\frac{16-\sqrt{6}}{360}$ |                    |
|  |                           | $R = O(h^{10})$    |

Square<sup>4</sup>  $S: |x| \leq h, |y| \leq h$

25.4.62

$$\frac{1}{4h^2} \iint_S f(x, y) dx dy = \sum_{i=1}^n w_i f(x_i, y_i) + R$$

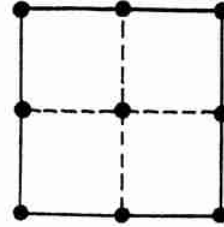

|                  |        |              |
|------------------|--------|--------------|
| $(x_i, y_i)$     | $w_i$  |              |
| $(0, 0)$         | $4/9$  |              |
| $(\pm h, \pm h)$ | $1/36$ | $R = O(h^4)$ |
| $(\pm h, 0)$     | $1/9$  |              |
| $(0, \pm h)$     | $1/9$  |              |

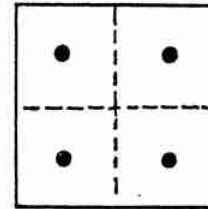

|  |       |              |
|--|-------|--------------|
| $(x_i, y_i)$   | $w_i$ |              |
| $(\pm h\sqrt{\frac{1}{3}}, \pm h\sqrt{\frac{1}{3}})$ | $1/4$ | $R = O(h^4)$ |

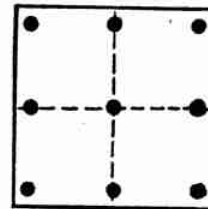

|              |         |
|--------------|---------|
| $(x_i, y_i)$ | $w_i$   |
| $(0, 0)$     | $16/81$ |

<sup>4</sup> For regions, such as the square, cube, cylinder, etc., which are the Cartesian products of lower dimensional regions, one may always develop integration rules by "multiplying together" the lower dimensional rules. Thus if

$$\int_0^1 f(x) dx \approx \sum_{i=1}^n w_i f(x_i)$$

is a one dimensional rule, then

$$\int_0^1 \int_0^1 f(x, y) dx dy \approx \sum_{i,j=1}^n w_i w_j f(x_i, y_j)$$

becomes a two dimensional rule. Such rules are not necessarily the most "economical".

$$\left(\pm\sqrt{\frac{3}{5}}h, \pm\sqrt{\frac{3}{5}}h\right) \quad 25/324 \quad R=O(h^6)$$

$$\left(0, \pm\sqrt{\frac{3}{5}}h\right) \quad 10/81$$

$$\left(\pm\sqrt{\frac{3}{5}}h, 0\right) \quad 10/81$$

**Equilateral Triangle T**

Radius of Circumscribed Circle= $h$

**25.4.63**

$$\frac{1}{\frac{3}{4}\sqrt{3}h^2} \iint_T f(x,y) dx dy = \sum_{i=1}^n w_i f(x_i, y_i) + R$$

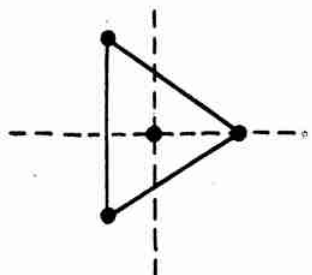

| $(x_i, y_i)$  | $w_i$  |            |
|---|--------|------------|
| $(0, 0)$  | $3/4$  | $R=O(h^3)$ |
| $(h, 0)$  | $1/12$ |            |
| $\left(-\frac{h}{2}, \pm\frac{h}{2}\sqrt{3}\right)$ | $1/12$ |            |

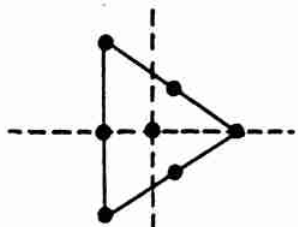

| $(x_i, y_i)$  | $w_i$   |            |
|---|---------|------------|
| $(0, 0)$  | $27/60$ | $R=O(h^4)$ |
| $(h, 0)$  | $3/60$  |            |
| $\left(-\frac{h}{2}, \pm\frac{h}{2}\sqrt{3}\right)$ | $3/60$  |            |
| $\left(-\frac{h}{2}, 0\right)$                      | $8/60$  |            |
| $\left(\frac{h}{4}, \pm\frac{h}{4}\sqrt{3}\right)$  | $8/60$  |            |

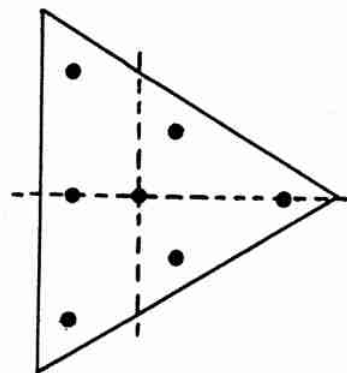

| $(x_i, y_i)$  | $w_i$                        |            |
|---|------------------------------|------------|
| $(0, 0)$  | $270/1200$                   | $R=O(h^6)$ |
| $\left(\left(\frac{\sqrt{15}+1}{7}\right)h, 0\right)$   | $\frac{155-\sqrt{15}}{1200}$ |            |
| $\left(\left(\frac{-\sqrt{15}+1}{14}\right)h, \pm\left(\frac{\sqrt{15}+1}{14}\right)\sqrt{3}h\right)$ |                              |            |
| $\left(\left(-\frac{\sqrt{15}-1}{7}\right)h, 0\right)$  | $\frac{155+\sqrt{15}}{1200}$ |            |
| $\left(\left(\frac{\sqrt{15}-1}{14}\right)h, \pm\left(\frac{\sqrt{15}-1}{14}\right)\sqrt{3}h\right)$  |                              |            |

**Regular Hexagon H**

Radius of Circumscribed Circle= $h$

**25.4.64**

$$\frac{1}{\frac{3}{2}\sqrt{3}h^2} \iint_H f(x,y) dx dy = \sum_{i=1}^n w_i f(x_i, y_i) + R$$

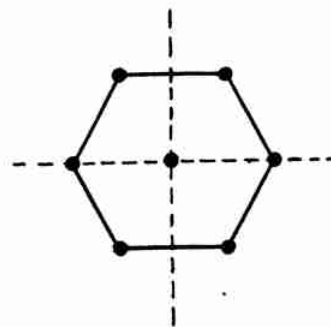

| $(x_i, y_i)$  | $w_i$   |            |
|---|---------|------------|
| $(0, 0)$  | $21/36$ | $R=O(h^4)$ |
| $\left(\pm\frac{h}{2}, \pm\frac{h}{2}\sqrt{3}\right)$ | $5/72$  |            |
| $(\pm h, 0)$  | $5/72$  |            |

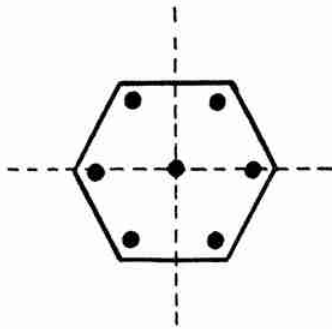

| $(x_i, y_i)$   | $w_i$    |              |
|--|----------|--------------|
| $(0, 0)$   | 258/1008 |              |
| $(\pm \frac{h}{10} \sqrt{14}, \pm \frac{h}{10} \sqrt{42})$ | 125/1008 | $R = O(h^6)$ |
| $(\pm h \frac{\sqrt{14}}{5}, 0)$                           | 125/1008 |              |

Surface of Sphere  $\Sigma: x^2 + y^2 + z^2 = h^2$

25.4.65

$$\frac{1}{4\pi h^2} \int_{\Sigma} f(x, y, z) d\sigma = \sum_{i=1}^n w_i f(x_i, y_i, z_i) + R$$

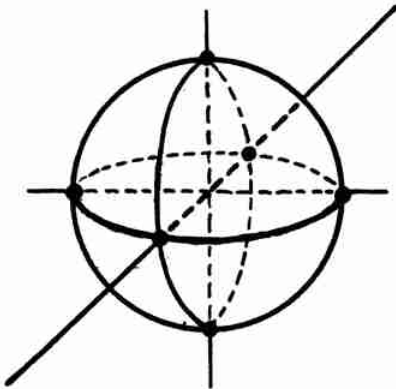

| $(x_i, y_i, z_i)$ | $w_i$ |              |
|-------------------|-------|--------------|
| $(\pm h, 0, 0)$   | 1/6   | $R = O(h^4)$ |
| $(0, \pm h, 0)$   | 1/6   |              |
| $(0, 0, \pm h)$   | 1/6   |              |
| $(\pm h, 0, 0)$   | 1/6   |              |

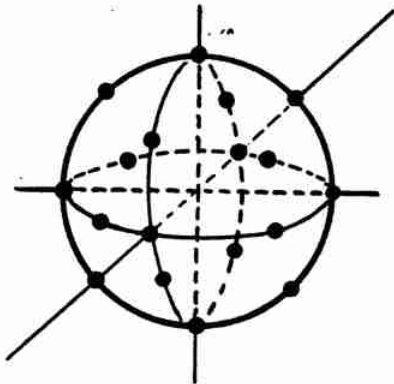

| $(x_i, y_i, z_i)$   | $w_i$        |
|---|--------------|
| $(\pm \sqrt{\frac{1}{2}} h, \pm \sqrt{\frac{1}{2}} h, 0)$ |              |
| $(\pm \sqrt{\frac{1}{2}} h, 0, \pm \sqrt{\frac{1}{2}} h)$ | 1/15         |
| $(0, \pm \sqrt{\frac{1}{2}} h, \pm \sqrt{\frac{1}{2}} h)$ |              |
| $(\pm h, 0, 0)$   | $R = O(h^6)$ |
| $(0, \pm h, 0)$   | 1/30         |

| $(x_i, y_i, z_i)$  | $w_i$               |
|--|---------------------|
| $(\pm \sqrt{\frac{1}{3}} h, \pm \sqrt{\frac{1}{3}} h, \pm \sqrt{\frac{1}{3}} h)$ | 27/840              |
| $(\pm \sqrt{\frac{1}{2}} h, \pm \sqrt{\frac{1}{2}} h, 0)$                        |                     |
| $(\pm \sqrt{\frac{1}{2}} h, 0, \pm \sqrt{\frac{1}{2}} h)$                        | 32/840 $R = O(h^6)$ |
| $(0, \pm \sqrt{\frac{1}{2}} h, \pm \sqrt{\frac{1}{2}} h)$                        |                     |
| $(\pm h, 0, 0)$  |                     |
| $(0, \pm h, 0)$  | 40/840              |
| $(0, 0, \pm h)$  |                     |

Sphere  $S: x^2 + y^2 + z^2 \leq h^2$

25.4.66

$$\frac{1}{\frac{4}{3} \pi h^3} \iiint_S f(x, y, z) dx dy dz = \sum_{i=1}^n w_i f(x_i, y_i, z_i) + R$$

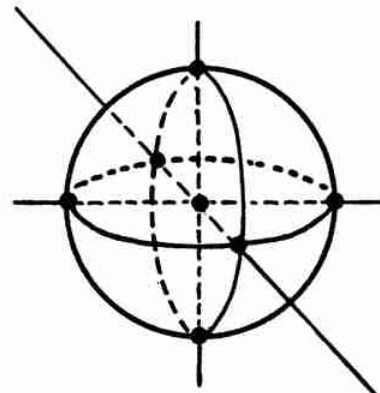

|                   |        |              |
|-------------------|--------|--------------|
| $(x_i, y_i, z_i)$ | $w_i$  |              |
| $(0, 0, 0)$       | $2/5$  |              |
| $(\pm h, 0, 0)$   | $1/10$ | $R = O(h^4)$ |
| $(0, \pm h, 0)$   | $1/10$ |              |
| $(0, 0, \pm h)$   | $1/10$ |              |

Cube<sup>5</sup>  $C$ :  $|x| \leq h$   
 $|y| \leq h$   
 $|z| \leq h$

25.4.67

$$\frac{1}{8h^3} \iiint_C f(x, y, z) dx dy dz = \sum_{i=1}^n w_i f(x_i, y_i, z_i) + R$$

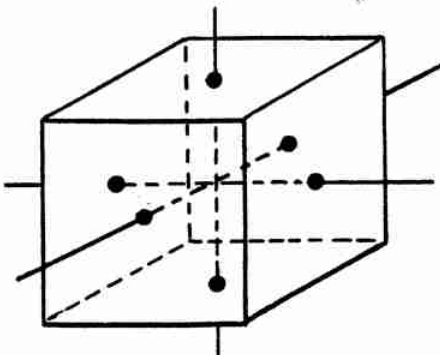

|                   |       |              |
|-------------------|-------|--------------|
| $(x_i, y_i, z_i)$ | $w_i$ |              |
| $(\pm h, 0, 0)$   | $1/6$ | $R = O(h^4)$ |
| $(0, \pm h, 0)$   | $1/6$ |              |
| $(0, 0, \pm h)$   | $1/6$ |              |

25.4.68

$$\frac{1}{8h^3} \iiint_C f(x, y, z) dx dy dz = \frac{1}{360} [-496f_m + 128 \sum f_r + 8 \sum f_f + 5 \sum f_e] + O(h^6)$$

25.4.69

$$= \frac{1}{450} [91 \sum f_r - 40 \sum f_e + 16 \sum f_d] + O(h^6)$$

where  $f_m = f(0, 0, 0)$ .

<sup>5</sup> See footnote to 25.4.62.

$\sum f_r$  = sum of values of  $f$  at the 6 points midway from the center of  $C$  to the 6 faces.

$\sum f_f$  = sum of values of  $f$  at the 6 centers of the faces of  $C$ .

$\sum f_e$  = sum of values of  $f$  at the 8 vertices of  $C$ .

$\sum f_d$  = sum of values of  $f$  at the 12 midpoints of edges of  $C$ .

$\sum f_a$  = sum of values of  $f$  at the 4 points on the diagonals of each face at a distance of  $\frac{1}{2}\sqrt{5}h$  from the center of the face.

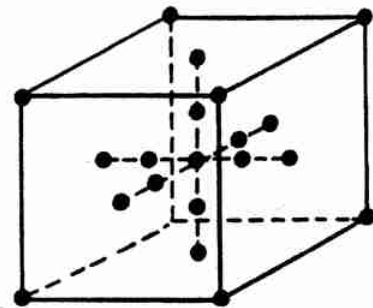

Tetrahedron:  $\mathcal{T}$

25.4.70

$$\begin{aligned} \frac{1}{V} \iiint_{\mathcal{T}} f(x, y, z) dx dy dz &= \frac{1}{40} \sum f_v + \frac{9}{40} \sum f_r \\ &\quad + \text{terms of 4}^{\text{th}} \text{ order} \\ &= \frac{32}{60} f_m + \frac{1}{60} \sum f_v + \frac{4}{60} \sum f_e \\ &\quad + \text{terms of 4}^{\text{th}} \text{ order} \end{aligned}$$

where

$V$ : Volume of  $\mathcal{T}$

$\sum f_v$ : Sum of values of the function at the vertices of  $\mathcal{T}$ .

$\sum f_e$ : Sum of values of the function at midpoints of the edges of  $\mathcal{T}$ .

$\sum f_r$ : Sum of values of the function at the center of gravity of the faces of  $\mathcal{T}$ .

$f_m$ : Value of function at center of gravity of  $\mathcal{T}$ .

25.5. Ordinary Differential Equations<sup>6</sup>First Order:  $y' = f(x, y)$ 

Point Slope Formula

25.5.1 
$$y_{n+1} = y_n + h y'_n + O(h^2)$$

25.5.2 
$$y_{n+1} = y_{n-1} + 2h y'_n + O(h^3)$$

Trapezoidal Formula

25.5.3 
$$y_{n+1} = y_n + \frac{h}{2} (y'_{n+1} + y'_n) + O(h^3)$$

Adams' Extrapolation Formula

25.5.4

$$y_{n+1} = y_n + \frac{h}{24} (55y'_n - 59y'_{n-1} + 37y'_{n-2} - 9y'_{n-3}) + O(h^5)$$

Adams' Interpolation Formula

25.5.5

$$y_{n+1} = y_n + \frac{h}{24} (9y'_{n+1} + 19y'_n - 5y'_{n-1} + y'_{n-2}) + O(h^5)$$

## Runge-Kutta Methods

Second Order

25.5.6

$$y_{n+1} = y_n + \frac{1}{2} (k_1 + k_2) + O(h^3)$$
$$k_1 = hf(x_n, y_n), k_2 = hf(x_n + h, y_n + k_1)$$

25.5.7

$$y_{n+1} = y_n + k_2 + O(h^3)$$
$$k_1 = hf(x_n, y_n), k_2 = hf\left(x_n + \frac{1}{2}h, y_n + \frac{1}{2}k_1\right)$$

Third Order

25.5.8

$$y_{n+1} = y_n + \frac{1}{6}k_1 + \frac{2}{3}k_2 + \frac{1}{6}k_3 + O(h^4)$$
$$k_1 = hf(x_n, y_n), k_2 = hf\left(x_n + \frac{1}{2}h, y_n + \frac{1}{2}k_1\right)$$
$$k_3 = hf(x_n + h, y_n - k_1 + 2k_2)$$

<sup>6</sup>The reader is cautioned against possible instabilities especially in formulas 25.5.2 and 25.5.13. See, e.g. [25.11], [25.12].

25.5.9

$$y_{n+1} = y_n + \frac{1}{4}k_1 + \frac{3}{4}k_3 + O(h^4)$$
$$k_1 = hf(x_n, y_n), k_2 = hf\left(x_n + \frac{1}{3}h, y_n + \frac{1}{3}k_1\right)$$
$$k_3 = hf\left(x_n + \frac{2}{3}h, y_n + \frac{2}{3}k_2\right)$$

Fourth Order

25.5.10

$$y_{n+1} = y_n + \frac{1}{6}k_1 + \frac{1}{3}k_2 + \frac{1}{3}k_3 + \frac{1}{6}k_4 + O(h^5)$$
$$k_1 = hf(x_n, y_n), k_2 = hf\left(x_n + \frac{1}{2}h, y_n + \frac{1}{2}k_1\right)$$
$$k_3 = hf\left(x_n + \frac{1}{2}h, y_n + \frac{1}{2}k_2\right), k_4 = hf(x_n + h, y_n + k_3)$$

25.5.11

$$y_{n+1} = y_n + \frac{1}{8}k_1 + \frac{3}{8}k_2 + \frac{3}{8}k_3 + \frac{1}{8}k_4 + O(h^5)$$
$$k_1 = hf(x_n, y_n), k_2 = hf\left(x_n + \frac{1}{3}h, y_n + \frac{1}{3}k_1\right)$$
$$k_3 = hf\left(x_n + \frac{2}{3}h, y_n - \frac{1}{3}k_1 + k_2\right),$$
$$k_4 = hf(x_n + h, y_n + k_1 - k_2 + k_3)$$

Gill's Method

25.5.12

$$y_{n+1} = y_n + \frac{1}{6} \left( k_1 + 2 \left( 1 - \sqrt{\frac{1}{2}} \right) k_2 \right. \\ \left. + 2 \left( 1 + \sqrt{\frac{1}{2}} \right) k_3 + k_4 \right) + O(h^5)$$
$$k_1 = hf(x_n, y_n)$$
$$k_2 = hf\left(x_n + \frac{1}{2}h, y_n + \frac{1}{2}k_1\right)$$
$$k_3 = hf\left(x_n + \frac{1}{2}h, y_n + \left(-\frac{1}{2} + \sqrt{\frac{1}{2}}\right)k_1\right. \\ \left. + \left(1 - \sqrt{\frac{1}{2}}\right)k_2\right)$$
$$k_4 = hf\left(x_n + h, y_n - \sqrt{\frac{1}{2}}k_2 + \left(1 + \sqrt{\frac{1}{2}}\right)k_3\right)$$

## Predictor-Corrector Methods

Milne's Methods

25.5.13

$$P: y_{n+1} = y_{n-3} + \frac{4h}{3} (2y'_n - y'_{n-1} + 2y'_{n-2}) + O(h^5)$$
$$C: y_{n+1} = y_{n-1} + \frac{h}{3} (y'_{n-1} + 4y'_n + y'_{n+1}) + O(h^5)$$

25.5.14

P:  $y_{n+1} = y_{n-5} + \frac{3h}{10} (11y'_n - 14y'_{n-1} + 26y'_{n-2} - 14y'_{n-3} + 11y'_{n-4}) + O(h^7)$

C:  $y_{n+1} = y_{n-3} + \frac{2h}{45} (7y'_{n+1} + 32y'_n + 12y'_{n-1} + 32y'_{n-2} + 7y'_{n-3}) + O(h^7)$

Formulas Using Higher Derivatives

25.5.15

P:  $y_{n+1} = y_{n-2} + 3(y_n - y_{n-1}) + h^2(y''_n - y''_{n-1}) + O(h^5)$

C:  $y_{n+1} = y_n + \frac{h}{2} (y'_{n+1} + y'_n) - \frac{h^2}{12} (y''_{n+1} - y''_n) + O(h^5)$

25.5.16

P:  $y_{n+1} = y_{n-2} + 3(y_n - y_{n-1}) + \frac{h^3}{2} (y'''_n + y'''_{n-1}) + O(h^7)$

C:  $y_{n+1} = y_n + \frac{h}{2} (y'_{n+1} + y'_n) - \frac{h^2}{10} (y''_{n+1} - y''_n) + \frac{h^3}{120} (y'''_{n+1} + y'''_n) + O(h^7)$

Systems of Differential Equations

First Order:  $y' = f(x, y, z), z' = g(x, y, z)$ .

Second Order Runge-Kutta

25.5.17

$y_{n+1} = y_n + \frac{1}{2} (k_1 + k_2) + O(h^3),$   
 $z_{n+1} = z_n + \frac{1}{2} (l_1 + l_2) + O(h^3)$

$k_1 = hf(x_n, y_n, z_n), \quad l_1 = hg(x_n, y_n, z_n)$

$k_2 = hf(x_n + h, y_n + k_1, z_n + l_1),$   
 $l_2 = hg(x_n + h, y_n + k_1, z_n + l_1)$

Fourth Order Runge-Kutta

25.5.18

$y_{n+1} = y_n + \frac{1}{6} (k_1 + 2k_2 + 2k_3 + k_4) + O(h^5),$   
 $z_{n+1} = z_n + \frac{1}{6} (l_1 + 2l_2 + 2l_3 + l_4) + O(h^5)$

$k_1 = hf(x_n, y_n, z_n) \quad l_1 = hg(x_n, y_n, z_n)$

$k_2 = hf\left(x_n + \frac{1}{2}h, y_n + \frac{1}{2}k_1, z_n + \frac{1}{2}l_1\right)$   
 $l_2 = hg\left(x_n + \frac{1}{2}h, y_n + \frac{1}{2}k_1, z_n + \frac{1}{2}l_1\right)$

$k_3 = hf\left(x_n + \frac{1}{2}h, y_n + \frac{1}{2}k_2, z_n + \frac{1}{2}l_2\right)$   
 $l_3 = hg\left(x_n + \frac{1}{2}h, y_n + \frac{1}{2}k_2, z_n + \frac{1}{2}l_2\right)$

$k_4 = hf(x_n + h, y_n + k_3, z_n + l_3)$   
 $l_4 = hg(x_n + h, y_n + k_3, z_n + l_3)$

Second Order:  $y'' = f(x, y, y')$

Milne's Method

25.5.19

P:  $y'_{n+1} = y'_{n-3} + \frac{4h}{3} (2y''_{n-2} - y''_{n-1} + 2y''_n) + O(h^5)$

C:  $y'_{n+1} = y'_{n-1} + \frac{h}{3} (y''_{n-1} + 4y''_n + y''_{n+1}) + O(h^5)$

Runge-Kutta Method

25.5.20

$y_{n+1} = y_n + h \left[ y'_n + \frac{1}{6} (k_1 + k_2 + k_3) \right] + O(h^5)$

$y'_{n+1} = y'_n + \frac{1}{6} (k_1 + 2k_2 + 2k_3 + k_4)$

$k_1 = hf(x_n, y_n, y'_n)$

$k_2 = hf\left(x_n + \frac{1}{2}h, y_n + \frac{h}{2}y'_n + \frac{h}{8}k_1, y'_n + \frac{k_1}{2}\right)$

$k_3 = hf\left(x_n + \frac{1}{2}h, y_n + \frac{h}{2}y'_n + \frac{h}{8}k_1, y'_n + \frac{k_2}{2}\right)$

$k_4 = hf\left(x_n + h, y_n + hy'_n + \frac{h}{2}k_3, y'_n + k_3\right)$

Second Order:  $y'' = f(x, y)$

Milne's Method

25.5.21

P:  $y_{n+1} = y_n + y_{n-2} - y_{n-3} + \frac{h^2}{4} (5y''_n + 2y''_{n-1} + 5y''_{n-2}) + O(h^6)$

C:  $y_n = 2y_{n-1} - y_{n-2} + \frac{h^2}{12} (y''_n + 10y''_{n-1} + y''_{n-2}) + O(h^6)$

Runge-Kutta Method

25.5.22  $y_{n+1} = y_n + h \left( y'_n + \frac{1}{6} (k_1 + 2k_2) \right) + O(h^4)$

$y'_{n+1} = y'_n + \frac{1}{6} k_1 + \frac{2}{3} k_2 + \frac{1}{6} k_3$

$k_1 = hf(x_n, y_n)$

$k_2 = hf\left(x_n + \frac{h}{2}, y_n + \frac{h}{2}y'_n + \frac{h}{8}k_1\right)$

$k_3 = hf\left(x_n + h, y_n + hy'_n + \frac{h}{2}k_2\right)$



## References

## Texts

(For textbooks on numerical analysis, see texts in chapter 3)

- [25.1] J. Balbrecht and L. Collatz, Zur numerischen Auswertung mehrdimensionaler Integrale, *Z. Angew. Math. Mech.* **38**, 1-15 (1958).
- [25.2] Berthod-Zaborowski, Le calcul des intégrales de la forme:  $\int_0^1 f(x) \log x \, dx$ .  
H. Mineur, *Techniques de calcul numérique*, pp. 555-556 (Librairie Polytechnique Ch. Béranger, Paris, France, 1952).
- [25.3] W. G. Bickley, Formulae for numerical integration, *Math. Gaz.* **23**, 352 (1939).
- [25.4] W. G. Bickley, Formulae for numerical differentiation, *Math. Gaz.* **25**, 19-27 (1941).
- [25.5] W. G. Bickley, Finite difference formulae for the square lattice, *Quart. J. Mech. Appl. Math.*, **1**, 35-42 (1948).
- [25.6] G. Birkhoff and D. Young, Numerical quadrature of analytic and harmonic functions, *J. Math. Phys.* **29**, 217-221 (1950).
- [25.7] L. Fox, The use and construction of mathematical tables, *Mathematical Tables vol. I*, National Physical Laboratory (Her Majesty's Stationery Office, London, England, 1956).
- [25.8] S. Gill, Process for the step-by-step integration of differential equations in an automatic digital computing machine, *Proc. Cambridge Philos. Soc.* **47**, 96-108 (1951).
- [25.9] P. C. Hammer and A. H. Stroud, Numerical evaluation of multiple integrals II, *Math. Tables Aids Comp.* **12**, 272-280 (1958).
- [25.10] P. C. Hammer and A. W. Wymore, Numerical evaluation of multiple integrals I, *Math. Tables Aids Comp.* **11**, 59-67 (1957).
- [25.11] P. Henrici, Discrete variable methods in ordinary differential equations (John Wiley & Sons, Inc., New York, N. Y., 1961).
- [25.12] F. B. Hildebrand, Introduction to numerical analysis (McGraw-Hill Book Co., Inc., New York, N. Y., 1956).
- [25.13] Z. Kopal, Numerical analysis (John Wiley & Sons, Inc., New York, N. Y., 1955).
- [25.14] A. A. Markoff, *Differenzenrechnung* (B. G. Teubner, Leipzig, Germany, 1896).
- [25.15] S. E. Mikeladze, Quadrature formulas for a regular function, *Soobšč. Akad. Nauk Gruzin. SSR.* **17**, 289-296 (1956).
- [25.16] W. E. Milne, A note on the numerical integration of differential equations, *J. Research NBS* **43**, 537-542 (1949) RP2046.
- [25.17] D. J. Panov, Formelsammlung zur numerischen Behandlung partieller Differentialgleichungen nach dem Differenzenverfahren (Akad. Verlag, Berlin, Germany, 1955).
- [25.18] E. Radau, Études sur les formules d'approximation qui servent à calculer la valeur d'une intégrale définie, *J. Math. Pures Appl.* (3) **6**, 283-336 (1880).
- [25.19] R. D. Richtmeyer, Difference methods for initial-value problems (Interscience Publishers, New York, N. Y., 1957).
- [25.20] M. Sadowsky, A formula for approximate computation of a triple integral, *Amer. Math. Monthly* **47**, 539-543 (1940).
- [25.21] H. E. Salzer, A new formula for inverse interpolation, *Bull. Amer. Math. Soc.* **50**, 513-516 (1944).
- [25.22] H. E. Salzer, Formulas for complex Cartesian interpolation of higher degree, *J. Math. Phys.* **28**, 200-203 (1949).
- [25.23] H. E. Salzer, Formulas for numerical integration of first and second order differential equations in the complex plane, *J. Math. Phys.* **29**, 207-216 (1950).
- [25.24] H. E. Salzer, Formulas for numerical differentiation in the complex plane, *J. Math. Phys.* **31**, 155-169 (1952).
- [25.25] A. Sard, Integral representations of remainders, *Duke Math. J.* **15**, 333-345 (1948).
- [25.26] A. Sard, Remainders: functions of several variables, *Acta Math.* **84**, 319-346 (1951).
- [25.27] G. Schulz, Formelsammlung zur praktischen Mathematik (DeGruyter and Co., Berlin, Germany, 1945).
- [25.28] A. H. Stroud, A bibliography on approximate integration, *Math. Comp.* **15**, 52-80 (1961).
- [25.29] G. J. Tranter, Integral transforms in mathematical physics (John Wiley & Sons, Inc., New York, N. Y., 1951).
- [25.30] G. W. Tyler, Numerical integration with several variables, *Canad. J. Math.* **5**, 393-412 (1953).

## Tables

- [25.31] L. J. Comrie, Chambers' six-figure mathematical tables, vol. 2 (W. R. Chambers, Ltd., London, England, 1949).
- [25.32] P. Davis and P. Rabinowitz, Abscissas and weights for Gaussian quadratures of high order, *J. Research NBS* **56**, 35-37 (1956) RP2645.
- [25.33] P. Davis and P. Rabinowitz, Additional abscissas and weights for Gaussian quadratures of high order: Values for  $n=64, 80$ , and  $96$ , *J. Research NBS* **60**, 613-614 (1958) RP2875.
- [25.34] E. W. Dijkstra and A. van Wijngaarden, Table of Everett's interpolation coefficients (Elsevier's Photo-offset, The Hague, Holland, 1955).
- [25.35] H. Fishman, Numerical integration constants, *Math. Tables Aids Comp.* **11**, 1-9 (1957).
- [25.36] H. J. Gawlik, Zeros of Legendre polynomials of orders 2-64 and weight coefficients of Gauss quadrature formulae, A.R.D.E. Memo (B) 77/58, Fort Halstead, Kent, England (1958).
- [25.37] Gt. Britain H.M. Nautical Almanac Office, Interpolation and allied tables (Her Majesty's Stationery Office, London, England, 1956).

- [25.38] I. M. Longman, Tables for the rapid and accurate numerical evaluation of certain infinite integrals involving Bessel functions, *Math. Tables Aids Comp.* **11**, 166-180 (1957).
- [25.39] A. N. Lowan, N. Davids, and A. Levenson, Table of the zeros of the Legendre polynomials of order 1-16 and the weight coefficients for Gauss' mechanical quadrature formula, *Bull. Amer. Math. Soc.* **48**, 739-743 (1942).
- [25.40] National Bureau of Standards, Tables of Lagrangian interpolation coefficients (Columbia Univ. Press, New York, N.Y., 1944).
- [25.41] National Bureau of Standards, Collected Short Tables of the Computation Laboratory, Tables of functions and of zeros of functions, *Applied Math. Series 37* (U.S. Government Printing Office, Washington, D.C., 1954).
- [25.42] P. Rabinowitz, Abscissas and weights for Lobatto quadrature of high order, *Math. Tables Aids Comp.* **69**, 47-52 (1960).
- [25.43] P. Rabinowitz and G. Weiss, Tables of abscissas and weights for numerical evaluation of integrals of the form
- $$\int_0^{\infty} e^{-zx} f(x) dx,$$
- Math. Tables Aids Comp.* **68**, 285-294 (1959).
- [25.44] H. E. Salzer, Tables for facilitating the use of Chebyshev's quadrature formula, *J. Math. Phys.* **26**, 191-194 (1947).
- [25.45] H. E. Salzer and R. Zucker, Table of the zeros and weight factors of the first fifteen Laguerre polynomials, *Bull. Amer. Math. Soc.* **55**, 1004-1012 (1949).
- [25.46] H. E. Salzer, R. Zucker, and R. Capuano, Table of the zeros and weight factors of the first twenty Hermite polynomials, *J. Research NBS* **48**, 111-116 (1952) RP2294.
- [25.47] H. E. Salzer, Table of coefficients for obtaining the first derivative without differences, *NBS Applied Math. Series 2* (U.S. Government Printing Office, Washington, D.C., 1948).
- [25.48] H. E. Salzer, Coefficients for facilitating trigonometric interpolation, *J. Math. Phys.* **27**, 274-278 (1949).
- [25.49] H. E. Salzer and P. T. Roberson, Table of coefficients for obtaining the second derivative without differences, *Convair-Astronautics*, San Diego, Calif. (1957).
- [25.50] H. E. Salzer, Tables of osculatory interpolation coefficients, *NBS Applied Math. Series 56* (U.S. Government Printing Office, Washington, D.C., 1958).

# 26. Probability Functions

MARVIN ZELEN<sup>1</sup> AND NORMAN C. SEVERO<sup>2</sup>

## Contents

|  | Page |
|--|------|
| <b>Mathematical Properties . . . . .</b>   | 927  |
| 26.1. Probability Functions: Definitions and Properties . . . . .  | 927  |
| 26.2. Normal or Gaussian Probability Function . . . . .  | 931  |
| 26.3. Bivariate Normal Probability Function . . . . .  | 936  |
| 26.4. Chi-Square Probability Function . . . . .  | 940  |
| 26.5. Incomplete Beta Function . . . . .   | 944  |
| 26.6. <i>F</i> -(Variance-Ratio) Distribution Function . . . . .   | 946  |
| 26.7. Student's <i>t</i> -Distribution . . . . .   | 948  |
| <b>Numerical Methods . . . . .</b>   | 949  |
| 26.8. Methods of Generating Random Numbers and Their Applications . . . . .  | 949  |
| 26.9. Use and Extension of the Tables . . . . .  | 953  |
| <b>References . . . . .</b>  | 961  |
| <b>Table 26.1. Normal Probability Function and Derivatives (<math>0 \leq x \leq 5</math>). . . . .</b>                                   | 966  |
| $P(x)$ , $Z(x)$ , $Z^{(1)}(x)$ , 15D   |      |
| $Z^{(2)}(x)$ , 10D; $Z^{(n)}(x)$ , $n=3(1)6$ , 8D  |      |
| $x=0(.02)3$  |      |
| $P(x)$ , 10D; $Z(x)$ , 10S; $Z^{(n)}(x)$ , $n=1(1)6$ , 8S  |      |
| $x=3(.05)5$  |      |
| <b>Table 26.2. Normal Probability Function for Large Arguments (<math>5 \leq x \leq 500</math>) . . . . .</b>                            | 972  |
| $-\log Q(x)$ , $x=5(1)50(10)100(50)500$ , 5D   |      |
| <b>Table 26.3. Higher Derivatives of the Normal Probability Function (<math>0 \leq x \leq 5</math>) . . . . .</b>                        | 974  |
| $Z^{(n)}(x)$ , $n=7(1)12$ , $x=0(.1)5$ , 8S  |      |
| <b>Table 26.4. Normal Probability Function—Values of <math>Z(x)</math> in Terms of <math>P(x)</math> and <math>Q(x)</math> . . . . .</b> | 975  |
| $Q(x)=0(.001).5$ , 5D  |      |
| <b>Table 26.5. Normal Probability Function—Values of <math>x</math> in Terms of <math>P(x)</math> and <math>Q(x)</math> . . . . .</b>    | 976  |
| $Q(x)=0(.001).5$ , 5D  |      |

<sup>1</sup> National Bureau of Standards. (Presently, National Institutes of Health.)

<sup>2</sup> National Bureau of Standards. (Presently, University of Buffalo.)

# 26. Probability Functions

## Mathematical Properties<sup>3</sup>

### 26.1. Probability Functions: Definitions and Properties

#### Univariate Cumulative Distribution Functions

A real-valued function  $F(x)$  is termed a (univariate) cumulative distribution function (c.d.f.) or simply distribution function if

- i)  $F(x)$  is non-decreasing, i.e.,  $F(x_1) \leq F(x_2)$  for  $x_1 \leq x_2$
- ii)  $F(x)$  is everywhere continuous from the right, i.e.,  $F(x) = \lim_{\epsilon \rightarrow 0^+} F(x + \epsilon)$
- iii)  $F(-\infty) = 0, F(\infty) = 1$ .

The function  $F(x)$  signifies the probability of the event " $X \leq x$ " where  $X$  is a random variable, i.e.,  $Pr\{X \leq x\} = F(x)$ , and thus describes the c.d.f. of  $X$ . The two principal types of distribution functions are termed *discrete* and *continuous*.

*Discrete Distributions:* Discrete distributions are characterized by the random variable  $X$  taking on an enumerable number of values . . . ,  $x_{-1}, x_0, x_1, \dots$  with point probabilities

$$p_n = Pr\{X = x_n\} \geq 0$$

which need only be subject to the restriction

$$\sum_n p_n = 1.$$

The corresponding distribution function can then be written

$$26.1.1 \quad F(x) = Pr\{X \leq x\} = \sum_{x_n \leq x} p_n$$

<sup>3</sup> Comment on notation and conventions.

a. We follow the customary convention of denoting a random variable by a capital letter, i.e.,  $X$ , and using the corresponding lower case letter, i.e.,  $x$ , for a particular value that the random variable assumes.

b. For statistical applications it is often convenient to have tabulated the "upper tail area,"  $1 - F(x)$ , or the c.d.f. for  $|X|$ ,  $F(x) - F(-x)$ , instead of simply the c.d.f.  $F(x)$ . We use the notation  $P$  to indicate the c.d.f. of  $X$ ,  $Q = 1 - P$  to indicate the "upper tail area" and  $A = P - Q$  to denote the c.d.f. of  $|X|$ . In particular we use  $P(x)$ ,  $Q(x)$ , and  $A(x)$  to denote the corresponding functions for the normal or Gaussian probability function, see 26.2.2-26.2.4. When these distributions depend on other parameters, say  $\theta_1$  and  $\theta_2$ , we indicate this by writing  $P(x|\theta_1, \theta_2)$ ,  $Q(x|\theta_1, \theta_2)$ , or  $A(x|\theta_1, \theta_2)$ . For example the chi-square distribution 26.4 depends on the parameter  $\nu$  and the tabulated function is written  $Q(\chi^2|\nu)$ .

\*See page II.

where the summation is over all values of  $x$  for which  $x_n \leq x$ . The set  $\{x_n\}$  of values for which  $p_n > 0$  is termed the domain of the random variable  $X$ . A discrete distribution of a random variable is called a *lattice distribution* if there exist numbers  $a$  and  $b \neq 0$  such that every possible value of  $X$  can be represented in the form  $a + bn$  where  $n$  takes on only integral values. A summary of some properties of certain discrete distributions is presented in 26.1.19-26.1.24.

*Continuous Distributions.* Continuous distributions are characterized by  $F(x)$  being absolutely continuous. Hence  $F(x)$  possesses a derivative  $F'(x) = f(x)$  and the c.d.f. can be written

$$26.1.2 \quad F(x) = Pr\{X \leq x\} = \int_{-\infty}^x f(t) dt.$$

The derivative  $f(x)$  is termed the *probability density function* (p.d.f.) or *frequency function*, and the values of  $x$  for which  $f(x) > 0$  make up the domain of the random variable  $X$ . A summary of some properties of certain selected continuous distributions is presented in 26.1.25-26.1.34.

#### Multivariate Probability Functions

The real-valued function  $F(x_1, x_2, \dots, x_n)$  defines an  $n$ -variate cumulative distribution function if

- i)  $F(x_1, x_2, \dots, x_n)$  is a non-decreasing function for each  $x_i$
- ii)  $F(x_1, x_2, \dots, x_n)$  is continuous from the right in each  $x_i$ ; i.e.,  $F(x_1, x_2, \dots, x_n) = \lim_{\epsilon \rightarrow 0^+} F(x_1, \dots, x_i + \epsilon, \dots, x_n)$
- iii)  $F(x_1, x_2, \dots, x_n) = 0$  when any  $x_i = -\infty$ ;  $F(\infty, \infty, \dots, \infty) = 1$ .
- iv)  $F(x_1, x_2, \dots, x_n)$  assigns nonnegative probability to the event  $x_1 < X_1 \leq x_1 + h_1, x_2 < X_2 \leq x_2 + h_2, \dots, x_n < X_n \leq x_n + h_n$  for all  $x_1, x_2, \dots, x_n$  and all nonnegative  $h_1, h_2, \dots, h_n$ , e.g., for  $n=2$ ,  $F(x_1 + h_1, x_2 + h_2) - F(x_1, x_2 + h_2) - F(x_1 + h_1, x_2) + F(x_1, x_2) \geq 0$  and in general for  $x_i < X_i \leq x_i + h_i$  ( $i=1, 2, \dots, n$ ), the  $k$ th order difference  $\Delta_k F(x_1, x_2, \dots, x_n) > 0$  for  $k=1, 2, \dots, n$ .

The joint probability of the event  $X_1 \leq x_1, X_2 \leq x_2, \dots, X_n \leq x_n$  is  $F(x_1, x_2, \dots, x_n)$ . Analogous to the one-dimensional case, discrete distributions assign all probability to an enumerable set of

vectors  $(x_1, x_2, \dots, x_n)$  and continuous distributions are characterized by absolute continuity of  $F(x_1, x_2, \dots, x_n)$ .

Characteristics of distribution functions: Moments, characteristic functions, cumulants

|         |   | Continuous distributions   | Discrete distributions   |
|---------|---|--|--|
| 26.1.3  | $n^{\text{th}}$ moment about origin             | $\mu'_n = \int_{-\infty}^{\infty} x^n f(x) dx$                           | $\mu'_n = \sum_g x_g^n p_g$  |
| 26.1.4  | mean  | $m = \mu'_1 = \int_{-\infty}^{\infty} x f(x) dx$                         | $m = \mu'_1 = \sum_g x_g p_g$  |
| 26.1.5  | variance  | $\sigma^2 = \mu'_2 - m^2 = \int_{-\infty}^{\infty} (x-m)^2 f(x) dx$      | $\sigma^2 = \mu'_2 - m^2 = \sum_g (x_g - m)^2 p_g$   |
| 26.1.6  | $n^{\text{th}}$ central moment                  | $\mu_n = \int_{-\infty}^{\infty} (x-m)^n f(x) dx$                        | $\mu_n = \sum_g (x_g - m)^n p_g$   |
| 26.1.7  | expected value operator for the function $g(x)$ | $E[g(X)] = \int_{-\infty}^{\infty} g(x) f(x) dx$                         | $E[g(X)] = \sum_g g(x_g) p_g$  |
| 26.1.8  | characteristic function of $X$                  | $\phi(t) = E(e^{itX}) = \int_{-\infty}^{\infty} e^{itx} f(x) dx$         | $\phi(t) = E(e^{itX}) = \sum_g e^{itx_g} p_g$  |
| 26.1.9  | characteristic function of $g(X)$               | $\phi_g(t) = E(e^{itg(X)}) = \int_{-\infty}^{\infty} e^{itg(x)} f(x) dx$ | $\phi_g(t) = E(e^{itg(X)}) = \sum_g e^{itg(x_g)} p_g$  |
| 26.1.10 | inversion formula                               | $f(x) = \frac{1}{2\pi} \int_{-\infty}^{\infty} e^{-itx} \phi(t) dt$      | $p_n = \frac{b}{2\pi} \int_{-\pi/b}^{\pi/b} e^{-itx_n} \phi(t) dt$<br>(lattice distributions only) |

Relation of the Characteristic Function to Moments About the Origin

26.1.11  $\phi^{(n)}(0) = \left[ \frac{d^n}{dt^n} \phi(t) \right]_{t=0} = i^n \mu'_n$

Cumulant Function

26.1.12  $\ln \phi(t) = \sum_{n=0}^{\infty} \kappa_n \frac{(it)^n}{n!}$

$\kappa_n$  is called the  $n^{\text{th}}$  cumulant.

26.1.13  $\kappa_1 = m, \kappa_2 = \sigma^2, \kappa_3 = \mu_3, \kappa_4 = \mu_4 - 3\mu_2^2$

Relation of Central Moments to Moments About the Origin

26.1.14  $\mu_n = \sum_{j=0}^n \binom{n}{j} (-1)^{n-j} \mu'_j m^{n-j}$

Coefficients of Skewness and Excess

26.1.15  $\gamma_1 = \frac{\kappa_3}{\kappa_2^{3/2}} = \frac{\mu_3}{\sigma^3}$  (skewness)

26.1.16  $\gamma_2 = \frac{\kappa_4}{\kappa_2^2} = \frac{\mu_4}{\sigma^4} - 3$  (excess)

Occasionally coefficients of skewness and excess (or kurtosis) are given by

26.1.17  $\beta_1 = \gamma_1^2 = \left( \frac{\mu_3}{\sigma^3} \right)^2$  (skewness)

26.1.18  $\beta_2 = \gamma_2 + 3 = \frac{\mu_4}{\sigma^4}$  (excess or kurtosis)

Some one-dimensional discrete distribution functions

| Name                                  | Domain  | Point Probabilities  | Restrictions on Parameters  | Mean            | Variance              | Skewness $\gamma_1$   | Excess $\gamma_2$     | Characteristic function  | Cumulants  |
|---------------------------------------|---|--|---|-----------------|-----------------------|---|-----------------------|--|--|
| 26.1.19<br>Single point or degenerate | $x=c$ ( $c$ a constant)                       | $p=1$  | $-\infty < c < +\infty$   | $c$             | 0                     |   |                       | $e^{ct}$   | $\kappa_1 = \lambda, \kappa_r = 0$ for $r > 1$   |
| 26.1.20<br>Binomial                   | $x_s = s$ , for $s=0, 1, 2, \dots, n$         | $\binom{n}{s} p^s (1-p)^{n-s}$                               | $0 < p < 1$ ( $q=1-p$ )   | $np$            | $npq$                 | $\frac{q-p}{\sqrt{npq}}$  | $\frac{1-6pq}{npq}$   | $(q+pe^{it})^n$  | $\kappa_1 = np$<br>$\kappa_{r+1} = pq \frac{d\kappa_r}{dp}$ for $r \geq 1$               |
| 26.1.21<br>Hypergeometric             | $x_s = s$ , for $s=0, 1, \dots, \min(n, N_1)$ | $\frac{\binom{N_1}{s} \binom{N_2}{n-s}}{\binom{N_1+N_2}{n}}$ | $N_1$ and $N_2$ integers, and $n \leq N_1+N_2$<br>( $N=N_1+N_2$ ,<br>$p=N_1/N$ and<br>$q=1-p=N_2/N$ ) | $np$            | $npq \frac{N-n}{N-1}$ | $\frac{q-p}{\sqrt{npq}} \left(\frac{N-1}{N-n}\right) \left(\frac{N-2n}{N-2}\right)$ | Complicated           | $\frac{\binom{N_1}{n}}{\binom{N}{n}} F(-n, -N_1; N_2-n+1; e^{it})$ | Complicated  |
| 26.1.22<br>Poisson                    | $x_s = s$ , for $s=0, 1, 2, \dots, \infty$    | $\frac{e^{-m} m^s}{s!}$                                      | $0 < m < \infty$  | $m$             | $m$                   | $m^{-1/2}$  | $m^{-1}$              | $e^m (e^{it}-1)$   | $\kappa_r = m$<br>for $r=1, 2, \dots$  |
| 26.1.23<br>Negative binomial          | $x_s = s$ , for $s=0, 1, 2, \dots, \infty$    | $\binom{n+s-1}{s} p^n (1-p)^s$                               | $n \geq 0$ and $0 < p < 1$<br>( $p=1/Q$ , and<br>$1-p=P/Q$ )  | $nP$            | $nPQ$                 | $\frac{Q+P}{\sqrt{nPQ}}$  | $\frac{1+6PQ}{nPQ}$   | $(Q-Pe^{it})^{-n}$   | $\kappa_1 = nP$<br>$\kappa_{r+1} = PQ \frac{d\kappa_r}{dQ}$<br>for $r \geq 1$            |
| 26.1.24<br>Geometric                  | $x_s = s$ , for $s=0, 1, 2, \dots, \infty$    | $p(1-p)^s$   | $0 < p < 1$   | $\frac{1-p}{p}$ | $\frac{1-p}{p^2}$     | $\frac{2-p}{\sqrt{1-p}}$  | $6 + \frac{p^2}{1-p}$ | $p[1-(1-p)e^{it}]^{-1}$  | $\kappa_1 = \frac{1-p}{p}$<br>$\kappa_{r+1} = -(1-p) \frac{d\kappa_r}{dp}$<br>$r \geq 1$ |

Some one-dimensional continuous distribution functions

|         | Name   | Domain  | Probability Density Function $f(x)$   | Restrictions on Parameters  | Mean                   | Variance                    | Skewness $\gamma_1$      | Excess $\gamma_2$ | Characteristic function                              | Cumulants   |
|---------|--|---|---|---|------------------------|-----------------------------|--------------------------|-------------------|--|---|
| 26.1.25 | Error function   | $-\infty < x < \infty$                        | $\frac{h}{\sqrt{\pi}} e^{-h^2 x^2}$   | $0 < h < \infty$  | 0                      | $\frac{1}{2h^2}$            | 0                        | 0                 | $\frac{-t^2}{e^{4ht^2}}$                             | $\kappa_1=0, \kappa_2=\frac{1}{2h^2}$<br>$\kappa_n=0$ for $n>2$   |
| 26.1.26 | Normal   | $-\infty < x < \infty$                        | $\frac{1}{\sigma\sqrt{2\pi}} e^{-\frac{1}{2}\left(\frac{x-m}{\sigma}\right)^2}$ | $-\infty < m < \infty$<br>$0 < \sigma < \infty$                         | $m$                    | $\sigma^2$                  | 0                        | 0                 | $e^{imt - \frac{\sigma^2 t^2}{2}}$                   | $\kappa_1=m, \kappa_2=\sigma^2, \kappa_n=0$ for $n>2$   |
| 26.1.27 | Cauchy   | $-\infty < x < \infty$                        | $\frac{1}{\pi\beta} \frac{1}{1+\left(\frac{x-\alpha}{\beta}\right)^2}$          | $-\infty < \alpha < \infty$<br>$0 < \beta < \infty$                     | not defined            | not defined                 | not defined              | not defined       | $e^{i\alpha t - \beta t }$                           | not defined   |
| 26.1.28 | Exponential  | $\alpha \leq x < \infty$                      | $\frac{1}{\beta} e^{-\left(\frac{x-\alpha}{\beta}\right)}$                      | $-\infty < \alpha < \infty$<br>$0 < \beta < \infty$                     | $\alpha + \beta$       | $\beta^2$                   | 2                        | 6                 | $e^{i\alpha t} (1 - i\beta t)^{-1}$                  | $\kappa_1 = \alpha + \beta, \kappa_n = \beta^n \Gamma(n)$ for $n > 1$   |
| 26.1.29 | Laplace, or double exponential   | $-\infty < x < \infty$                        | $\frac{1}{2\beta} e^{-\left \frac{x-\alpha}{\beta}\right }$                     | $-\infty < \alpha < \infty$<br>$0 < \beta < \infty$                     | $\alpha$               | $2\beta^2$                  | 0                        | 3                 | $e^{i\alpha t} (1 + \beta^2 t^2)^{-1}$               | $\kappa_1 = \alpha, \kappa_2 = 2\beta^2$<br>$\kappa_{2n+1} = 0, \kappa_{2n} = \frac{(2n)!}{n} \beta^{2n}$<br>for $n = 1, 2, \dots$                                  |
| 26.1.30 | Extreme-Value, <sup>4</sup><br>(Fisher-Tippett Type I or doubly exponential) | $-\infty < x < \infty$                        | $\frac{1}{\beta} \exp(-y - e^{-y})$<br>with $y = \frac{x-\alpha}{\beta}$        | $-\infty < \alpha < \infty$<br>$0 < \beta < \infty$                     | $\alpha + \gamma\beta$ | $\frac{(\pi\beta)^2}{6}$    | 1.3                      | 2.4               | $\Gamma(1 - i\beta t) e^{i\alpha t}$                 | $\kappa_1 = \gamma, \kappa_2 = \frac{(\pi\beta)^2}{6}$<br>$\kappa_n = \beta^n \Gamma(n) \sum_{r=1}^{\infty} \frac{1}{r^n}$ for $n > 2$                              |
| 26.1.31 | Pearson Type III   | $\alpha \leq x < \infty$                      | $\frac{1}{\beta \Gamma(p)} y^{p-1} e^{-y}$<br>with $y = \frac{x-\alpha}{\beta}$ | $-\infty < \alpha < \infty$<br>$0 < \beta < \infty$<br>$0 < p < \infty$ | $\alpha + p\beta$      | $p\beta^2$                  | $\frac{2}{\sqrt{p}}$     | $6/p$             | $e^{i\alpha t} (1 - i\beta t)^{-p}$                  | $\kappa_1 = \alpha + p\beta, \kappa_n = \beta^n p \Gamma(n)$ for $n > 1$  |
| 26.1.32 | Gamma distribution   | $0 \leq x < \infty$                           | $\frac{1}{\Gamma(p)} x^{p-1} e^{-x}$  | $0 < p < \infty$  | $p$                    | $p$                         | $\frac{2}{\sqrt{p}}$     | $6/p$             | $(1 - it)^{-p}$                                      | $\kappa_1 = p, \kappa_n = p \Gamma(n)$ for $n > 1$  |
| 26.1.33 | Beta distribution  | $0 \leq x \leq 1$                             | $\frac{1}{B(a, b)} x^{a-1} (1-x)^{b-1}$   | $1 \leq a < \infty$<br>$1 \leq b < \infty$                              | $\frac{a}{a+b}$        | $\frac{ab}{(a+b)^2(a+b+1)}$ | $\frac{2(a-b)}{(a+b+2)}$ | See footnote 5.   | $M(a, a+b, it)$                                      |   |
| 26.1.34 | Rectangular, or uniform  | $m - \frac{h}{2} \leq x \leq m + \frac{h}{2}$ | $\frac{1}{h}$   | $-\infty < m < \infty$<br>$0 < h < \infty$                              | $m$                    | $\frac{h^2}{12}$            | 0                        | -1.2              | $\frac{2}{ht} \sin\left(\frac{ht}{2}\right) e^{imt}$ | $\kappa_1 = m, \kappa_{2n+1} = 0$<br>$\kappa_{2n} = \frac{h^{2n} B_{2n}}{2n}$<br>$B_{2n}$ (Bernoulli numbers),<br>$B_2 = \frac{1}{6}, B_4 = -\frac{1}{30}, \dots$ * |

<sup>4</sup>  $\gamma$  (Euler's constant) = .57721 56649 . . . .

<sup>5</sup>  $\gamma_2 = \sqrt{\frac{a+b+1}{ab}} \left\{ \frac{3(a+b+1)[2(a+b)^2 + ab(a+b-6)]}{ab(a+b+2)(a+b+3)} - 3 \right\}$ .

\* See page 11.



*Inequalities for distribution functions*

( $F(x)$  denotes the c.d.f. of the random variable  $X$  and  $t$  denotes a positive constant; further  $m$  is always assumed to be finite and all expectations are assumed to exist.)

| Inequality  | Conditions   |
|---|--|
| 26.1.35 $Pr\{g(X) \geq t\} \leq E[g(X)]/t$  | (i) $g(X) \geq 0$  |
| 26.1.36 $Pr\{X \geq t\} \leq m/t$<br>$F(t) \geq 1 - \frac{m}{t}$  | (i) $Pr\{X < 0\} = 0$<br>(ii) $E(X) = m$   |
| 26.1.37 $Pr\{ X - m  \geq t\sigma} \leq 1/t^2$<br>$F(m + t\sigma) - F(m - t\sigma) \geq 1 - \frac{1}{t^2}$  | (i) $E(X) = m$<br>(ii) $E(X - m)^2 = \sigma^2$ *   |
| 26.1.38 $Pr\{ \bar{X} - \bar{m}  \geq t\bar{\sigma}\} \leq \frac{1}{nt^2}$  | (i) $E(X_i) = m_i$<br>(ii) $E(X_i - m_i)^2 = \sigma_i^2$<br>(iii) $E[(X_i - m_i)(X_j - m_j)] = 0 (i \neq j)$   |
| 26.1.39 $Pr\{ X - m  \geq t\sigma\} \leq \frac{4}{9} \left\{ \frac{1 + \left(\frac{m - x_0}{\sigma}\right)^2}{\left(t - \left \frac{m - x_0}{\sigma}\right \right)^2} \right\}$<br>$F(m + t\sigma) - F(m - t\sigma) \geq 1 - \frac{4}{9} \left\{ \frac{1 + \left(\frac{m - x_0}{\sigma}\right)^2}{\left(t - \left \frac{m - x_0}{\sigma}\right \right)^2} \right\}$ | (iv) $\bar{X} = \sum_{i=1}^n \frac{X_i}{n}$<br>$\bar{m} = \sum_{i=1}^n \frac{m_i}{n}, \bar{\sigma} = \left[ \sum_{i=1}^n \frac{\sigma_i^2}{n} \right]^{1/2}$<br>(i) $E(X - m)^2 = \sigma^2$<br>(ii) $F(x)$ is a continuous c.d.f.<br>(iii) $F(x)$ is unimodal at $x_0^{\circ}$ |
| 26.1.40 $Pr\{ X - m  \geq t\sigma\} \leq 4/9t^2$<br>$F(m + t\sigma) - F(m - t\sigma) \geq 1 - \frac{4}{9t^2}$   | (i) $E(X - m)^2 = \sigma^2$<br>(ii) $F(x)$ is a continuous c.d.f.<br>(iii) $F(x)$ is unimodal at $x_0^{\circ}$<br>(iv) $m = x_0$   |
| 26.1.41 $Pr\{ X - m  \geq t\sigma\} \leq \frac{\mu_4 - \sigma^4}{\mu_4 + t^4\sigma^4 - 2t^2\sigma^4}$<br>$F(m + t\sigma) - F(m - t\sigma) \geq 1 - \frac{\mu_4 - \sigma^4}{\mu_4 + t^4\sigma^4 - 2t^2\sigma^4}$   | (i) $E(X - m)^2 = \sigma^2$<br>(ii) $E(X - m)^4 = \mu_4$   |

$x_0$  is such that  $F'(x_0) > F'(x)$  for  $x \neq x_0$ .

**26.2. Normal or Gaussian Probability Function**

- 26.2.1  $Z(x) = \frac{1}{\sqrt{2\pi}} e^{-x^2/2}$
- 26.2.2  $P(x) = \frac{1}{\sqrt{2\pi}} \int_{-\infty}^x e^{-t^2/2} dt = \int_{-\infty}^x Z(t) dt$
- 26.2.3  $Q(x) = \frac{1}{\sqrt{2\pi}} \int_x^{\infty} e^{-t^2/2} dt = \int_x^{\infty} Z(t) dt$
- 26.2.4  $A(x) = \frac{1}{\sqrt{2\pi}} \int_{-x}^x e^{-t^2/2} dt = \int_{-x}^x Z(t) dt$
- 26.2.5  $P(x) + Q(x) = 1$
- 26.2.6  $P(-x) = Q(x)$
- 26.2.7  $A(x) = 2P(x) - 1$

**Probability Integral with Mean  $m$  and Variance  $\sigma^2$**

A random variable  $X$  is said to be normally distributed with mean  $m$  and variance  $\sigma^2$  if the probability that  $X$  is less than or equal to  $x$  is given by

**26.2.8**

$$Pr\{X \leq x\} = \frac{1}{\sigma\sqrt{2\pi}} \int_{-\infty}^x e^{-\frac{(t-m)^2}{2\sigma^2}} dt$$

$$= \frac{1}{\sqrt{2\pi}} \int_{-\infty}^{(x-m)/\sigma} e^{-t^2/2} dt = P\left(\frac{x-m}{\sigma}\right).$$

The corresponding probability density function is

**26.2.9**

$$\frac{\partial}{\partial x} P\left(\frac{x-m}{\sigma}\right) = \frac{1}{\sigma} Z\left(\frac{x-m}{\sigma}\right) = \frac{1}{\sigma\sqrt{2\pi}} e^{-\frac{(x-m)^2}{2\sigma^2}}$$

and is symmetric around  $m$ , i.e.

$$Z\left(\frac{m+x}{\sigma}\right) = Z\left(\frac{m-x}{\sigma}\right).$$

The inflexion points of the probability density function are at  $m \pm \sigma$ .

Power Series ( $x \geq 0$ )

26.2.10 
$$P(x) = \frac{1}{2} + \frac{1}{\sqrt{2\pi}} \sum_{n=0}^{\infty} \frac{(-1)^n x^{2n+1}}{n! 2^n (2n+1)}$$

26.2.11

$$P(x) = \frac{1}{2} + Z(x) \sum_{n=0}^{\infty} \frac{x^{2n+1}}{1 \cdot 3 \cdot 5 \dots (2n+1)}$$

Asymptotic Expansions ( $x > 0$ )

26.2.12

$$Q(x) = \frac{Z(x)}{x} \left\{ 1 - \frac{1}{x^2} + \frac{1 \cdot 3}{x^4} + \dots + \frac{(-1)^{n+1} \cdot 3 \dots (2n-1)}{x^{2n}} \right\} + R_n$$

where

$$R_n = (-1)^{n+1} \cdot 3 \dots (2n+1) \int_x^{\infty} \frac{Z(t)}{t^{2n+2}} dt$$

which is less in absolute value than the first neglected term.

26.2.13

$$Q(x) \sim \frac{Z(x)}{x} \left\{ 1 - \frac{a_1}{x^2+2} + \frac{a_2}{(x^2+2)(x^2+4)} - \frac{a_3}{(x^2+2)(x^2+4)(x^2+6)} + \dots \right\}$$

where  $a_1=1, a_2=1, a_3=5, a_4=9, a_5=129$  and the general term is

$$a_n = c_0 \cdot 1 \cdot 3 \dots (2n-1) + 2c_1 \cdot 1 \cdot 3 \dots (2n-3) + 2^2 c_2 \cdot 1 \cdot 3 \dots (2n-5) + \dots + 2^{n-1} c_{n-1}$$

and  $c_s$  is the coefficient of  $t^{n-s}$  in the expansion of  $t(t-1) \dots (t-n+1)$ .

Continued Fraction Expansions

26.2.14

$$Q(x) = Z(x) \left\{ \frac{1}{x+} \frac{1}{x+} \frac{2}{x+} \frac{3}{x+} \frac{4}{x+} \dots \right\} \quad (x > 0)$$

26.2.15

$$Q(x) = \frac{1}{2} - Z(x) \left\{ \frac{x}{1-} \frac{x^2}{3-} \frac{2x^2}{5-} \frac{3x^2}{7-} \frac{4x^2}{9-} \dots \right\} \quad (x \geq 0)$$

Polynomial and Rational Approximations<sup>7</sup> for  $P(x)$  and  $Z(x)$

$$0 \leq x < \infty$$

26.2.16

$$P(x) = 1 - Z(x)(a_1 t + a_2 t^2 + a_3 t^3) + \epsilon(x), \quad t = \frac{1}{1+px}$$

$$|\epsilon(x)| < 1 \times 10^{-5}$$

$$p = .33267 \quad a_1 = .43618 \ 36$$

$$a_2 = -.12016 \ 76$$

$$a_3 = .93729 \ 80$$

26.2.17

$$P(x) = 1 - Z(x)(b_1 t + b_2 t^2 + b_3 t^3 + b_4 t^4 + b_5 t^5) + \epsilon(x), \quad t = \frac{1}{1+px}$$

$$|\epsilon(x)| < 7.5 \times 10^{-8}$$

$$p = .23164 \ 19$$

$$b_1 = .31938 \ 1530 \quad b_4 = -1.82125 \ 5978$$

$$b_2 = -.35656 \ 3782 \quad b_5 = 1.33027 \ 4429$$

$$b_3 = 1.78147 \ 7937$$

26.2.18

$$P(x) = 1 - \frac{1}{2} (1 + c_1 x + c_2 x^2 + c_3 x^3 + c_4 x^4)^{-4} + \epsilon(x)$$

$$|\epsilon(x)| < 2.5 \times 10^{-4}$$

$$c_1 = .196854 \quad c_3 = .000344$$

$$c_2 = .115194 \quad c_4 = .019527$$

26.2.19

$$P(x) = 1 - \frac{1}{2} (1 + d_1 x + d_2 x^2 + d_3 x^3 + d_4 x^4 + d_5 x^5 + d_6 x^6)^{-16} + \epsilon(x)$$

$$|\epsilon(x)| < 1.5 \times 10^{-7}$$

$$d_1 = .04986 \ 73470 \quad d_4 = .00003 \ 80036$$

$$d_2 = .02114 \ 10061 \quad d_5 = .00004 \ 88906$$

$$d_3 = .00327 \ 76263 \quad d_6 = .00000 \ 53830$$

26.2.20  $Z(x) = (a_0 + a_2 x^2 + a_4 x^4 + a_6 x^6)^{-1} + \epsilon(x)$

$$|\epsilon(x)| < 2.7 \times 10^{-3}$$

$$a_0 = 2.490895 \quad a_4 = -.024393$$

$$a_2 = 1.466003 \quad a_6 = .178257$$

<sup>7</sup> Based on approximations in C. Hastings, Jr., Approximations for digital computers. Princeton Univ. Press, Princeton, N.J., 1955 (with permission).

26.2.21

$$Z(x) = (b_0 + b_2x^2 + b_4x^4 + b_6x^6 + b_8x^8 + b_{10}x^{10})^{-1} + \epsilon(x)$$

$$|\epsilon(x)| < 2.3 \times 10^{-4}$$

$$b_0 = 2.50523 \ 67 \quad b_6 = .13064 \ 69$$

$$b_2 = 1.28312 \ 04 \quad b_8 = -.02024 \ 90$$

$$b_4 = .22647 \ 18 \quad b_{10} = .00391 \ 32$$

Rational Approximations <sup>7</sup> for  $x_p$  where  $Q(x_p) = p$

$$0 < p \leq .5$$

26.2.22

$$x_p = t - \frac{a_0 + a_1t}{1 + b_1t + b_2t^2} + \epsilon(p), \quad t = \sqrt{\ln \frac{1}{p^2}}$$

$$|\epsilon(p)| < 3 \times 10^{-3}$$

$$a_0 = 2.30753 \quad b_1 = .99229$$

$$a_1 = .27061 \quad b_2 = .04481$$

26.2.23

$$x_p = t - \frac{c_0 + c_1t + c_2t^2}{1 + d_1t + d_2t^2 + d_3t^3} + \epsilon(p), \quad t = \sqrt{\ln \frac{1}{p^2}}$$

$$|\epsilon(p)| < 4.5 \times 10^{-4}$$

$$c_0 = 2.515517 \quad d_1 = 1.432788$$

$$c_1 = .802853 \quad d_2 = .189269$$

$$c_2 = .010328 \quad d_3 = .001308$$

Bounds Useful as Approximations to the Normal Distribution Function

26.2.24

$$P(x) \leq \begin{cases} P_1(x) = \frac{1}{2} + \frac{1}{2} (1 - e^{-2x^2/\pi})^{\frac{1}{2}} & (x > 0) \\ P_2(x) = 1 - \frac{(4 + x^2)^{\frac{1}{2}} - x}{2} (2\pi)^{-\frac{1}{2}} e^{-x^2/2} & (x > 1.4) \end{cases}$$

26.2.25

$$P(x) \geq \begin{cases} P_3(x) = \frac{1}{2} + \frac{1}{2} \left( 1 - e^{-2x^2/\pi} - \frac{2(\pi-3)}{3\pi^2} x^4 e^{-x^2/2} \right)^{\frac{1}{2}} & (x > 0) \\ P_4(x) = 1 - \frac{1}{x} (2\pi)^{-\frac{1}{2}} e^{-x^2/2} & (x > 2.2) \end{cases}$$

See Figure 26.1 for error curves.

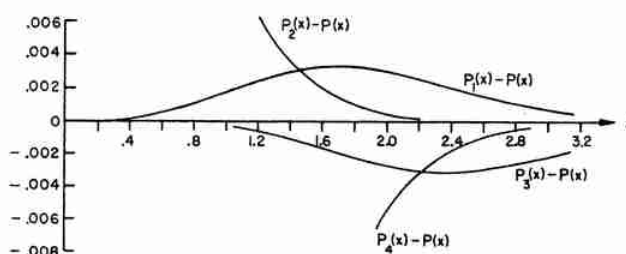

FIGURE 26.1. Error curves for bounds on normal distribution.

Derivatives of the Normal Probability Density Function

26.2.26  $Z^{(m)}(x) = \frac{d^m}{dx^m} Z(x)$

Differential Equation

26.2.27  $Z^{(m+2)}(x) + xZ^{(m+1)}(x) + (m+1)Z^{(m)}(x) = 0$

Value at  $x=0$

26.2.28

$$Z^{(m)}(0) = \begin{cases} \frac{(-1)^{m/2} m!}{\sqrt{2\pi} 2^{m/2} \left(\frac{m}{2}\right)!} & \text{for } m=2r, r=0, 1, \dots \\ 0 & \text{for odd } m > 0 \end{cases}$$

Relation of  $P(x)$  and  $Z^{(n)}(x)$  to Other Functions

| <i>Function</i>  | <i>Relation</i>  |              |
|--|--|--------------|
| 26.2.29 Error function                                   | $\operatorname{erf} x = 2P(x\sqrt{2}) - 1$   | $(x \geq 0)$ |
| 26.2.30 Incomplete gamma function (special case)         | $\frac{\gamma\left(\frac{1}{2}, x\right)}{\Gamma\left(\frac{1}{2}\right)} = [2P(\sqrt{2x}) - 1]$                     | $(x \geq 0)$ |
| 26.2.31 Hermite polynomial                               | $He_n(x) = (-1)^n \frac{Z^{(n)}(x)}{Z(x)}$   |              |
| 26.2.32 “  | $H_n(x) = (-1)^n 2^{n/2} \frac{Z^{(n)}(x\sqrt{2})}{Z(x\sqrt{2})}$  |              |
| 26.2.33 $Hh$ function                                    | $Hh_{-n}(x) = (-1)^{n-1} \sqrt{2\pi} Z^{(n-1)}(x)$   | $(n > 0)$    |
| 26.2.34 “  | $Hh_n(x) = \frac{(-1)^n}{n!} Hh_{-1}(x) \frac{d^n}{dx^n} \left( \frac{Q(x)}{Z(x)} \right)$ *                         | $(n > 0)$    |
| 26.2.35 Tetrachoric function                             | $\tau_n(x) = \frac{(-1)^{n-1}}{\sqrt{n!}} Z^{(n-1)}(x)$  |              |
| 26.2.36 Confluent hypergeometric function (special case) | $M\left(\frac{1}{2}, \frac{3}{2}, -\frac{x^2}{2}\right) = \frac{\sqrt{2\pi}}{x} \left\{ P(x) - \frac{1}{2} \right\}$ | $(x > 0)$    |
| 26.2.37 “  | $M\left(1, \frac{3}{2}, \frac{x^2}{2}\right) = \frac{1}{xZ(x)} \left\{ P(x) - \frac{1}{2} \right\}$                  | $(x > 0)$    |
| 26.2.38 “  | $M\left(\frac{2m+1}{2}, \frac{1}{2}, -\frac{x^2}{2}\right) = \frac{Z^{(2m)}(x)}{Z^{(2m)}(0)}$                        | $(x \geq 0)$ |
| 26.2.39 “  | $M\left(\frac{2m+2}{2}, \frac{3}{2}, -\frac{x^2}{2}\right) = \frac{Z^{(2m-1)}(x)}{xZ^{(2m)}(0)}$                     | $(x \geq 0)$ |
| 26.2.40 Parabolic cylinder function                      | $U\left(-n - \frac{1}{2}, x\right) = e^{-\frac{1}{2}x^2} (-1)^n \frac{Z^{(n)}(x)}{Z(x)}$                             | $(n > 0)$    |

## Repeated Integrals of the Normal Probability Integral

$$26.2.41 \quad I_n(x) = \int_x^\infty I_{n-1}(t) dt \quad (n \geq 0)$$

$$\text{where } I_{-1}(x) = Z(x)$$

## 26.2.42

$$I_{-n}(x) = \left(-\frac{d}{dx}\right)^{n-1} Z(x) = (-1)^{n-1} Z^{(n-1)}(x) \quad (n \geq -1)$$

$$26.2.43 \quad \left(\frac{d^2}{dx^2} + x \frac{dx}{dn} - n\right) I_n(x) = 0$$

## 26.2.44

$$(n+1)I_{n+1}(x) + xI_n(x) - I_{n-1}(x) = 0 \quad (n > -1)$$

\*See page II.

26.2.45

$$I_n(x) = \int_x^\infty \frac{(t-x)^n}{n!} Z(t) dt = e^{-x^2/2} \int_0^\infty \frac{t^n}{n!} Z(t) dt \quad (n > -1)$$

26.2.46  $I_n(0) = I_{-n}(0) = \frac{1}{\left(\frac{n}{2}\right)! 2^{\frac{n+2}{2}}} \quad (n \text{ even})$

Asymptotic Expansions of an Arbitrary Probability Density Function and Distribution Function

Let  $Y_i$  ( $i=1, 2, \dots, n$ ) be  $n$

independent random variables with mean  $m_i$ , variance  $\sigma_i^2$ , and higher cumulants  $\kappa_{r,i}$ . Then asymptotic expansions with respect to  $n$  for the probability density and cumulative distribution function of

$$X = \frac{\sum_{i=1}^m (Y_i - m_i)}{\left(\sum_{i=1}^m \sigma_i^2\right)^{1/2}} \text{ are}$$

26.2.47

$$f(x) \sim Z(x) - \left[ \frac{\gamma_1}{6} Z^{(3)}(x) \right] + \left[ \frac{\gamma_2}{24} Z^{(4)}(x) + \frac{\gamma_1^2}{72} Z^{(6)}(x) \right] - \left[ \frac{\gamma_3}{120} Z^{(5)}(x) + \frac{\gamma_1\gamma_2}{144} Z^{(7)}(x) + \frac{\gamma_1^3}{1296} Z^{(9)}(x) \right] + \left[ \frac{\gamma_4}{720} Z^{(6)}(x) + \frac{\gamma_2^2}{1152} Z^{(8)}(x) + \frac{\gamma_1\gamma_3}{720} Z^{(8)}(x) + \frac{\gamma_1^2\gamma_2}{1728} Z^{(10)}(x) + \frac{\gamma_1^4}{31104} Z^{(12)}(x) \right] + \dots$$

26.2.48

$$F(x) \sim P(x) - \left[ \frac{\gamma_1}{6} Z^{(2)}(x) \right] + \left[ \frac{\gamma_2}{24} Z^{(3)}(x) + \frac{\gamma_1^2}{72} Z^{(5)}(x) \right] - \left[ \frac{\gamma_3}{120} Z^{(4)}(x) + \frac{\gamma_1\gamma_2}{144} Z^{(6)}(x) + \frac{\gamma_1^3}{1296} Z^{(8)}(x) \right] + \left[ \frac{\gamma_4}{720} Z^{(5)}(x) + \frac{\gamma_2^2}{1152} Z^{(7)}(x) + \frac{\gamma_1\gamma_3}{720} Z^{(7)}(x) + \frac{\gamma_1^2\gamma_2}{1728} Z^{(9)}(x) + \frac{\gamma_1^4}{31104} Z^{(11)}(x) \right] + \dots$$

where

$$\gamma_{r-2} = \frac{1}{n^{\frac{r}{2}-1}} \frac{\left(\frac{1}{n} \sum_{i=1}^n \kappa_{r,i}\right)}{\left(\frac{1}{n} \sum_{i=1}^n \sigma_i^2\right)^{r/2}}$$

Terms in brackets are terms of the same order with respect to  $n$ . When the  $Y_i$  have the same distribution, then  $m_i = m$ ,  $\sigma_i^2 = \sigma^2$ ,  $\kappa_{r,i} = \kappa_r$  and

$$\gamma_{r-2} = \frac{1}{n^{\frac{r}{2}-1}} \left(\frac{\kappa_r}{\sigma^r}\right)$$

Asymptotic Expansion for the Inverse Function of an Arbitrary Distribution Function

Let the cumulative distribution function of  $Y = \sum_{i=1}^n Y_i$  be denoted by  $F(y)$ . Then the (Cornish-Fisher) asymptotic expansion with respect to  $n$  for the value of  $y_p$  such that  $F(y_p) = 1 - p$  is

26.2.49  $y_p \sim m + \sigma w$

where

$$w = x + [\gamma_1 h_1(x)] + [\gamma_2 h_2(x) + \gamma_1^2 h_{11}(x)] + [\gamma_3 h_3(x) + \gamma_1\gamma_2 h_{12}(x) + \gamma_1^3 h_{111}(x)] + [\gamma_4 h_4(x) + \gamma_2^2 h_{22}(x) + \gamma_1\gamma_3 h_{13}(x) + \gamma_1^2\gamma_2 h_{112}(x) + \gamma_1^4 h_{1111}(x)] + \dots$$

and

$$Q(x) = p, \quad \gamma_{r-2} = \frac{\kappa_r}{\kappa_2^{r/2}}, \quad r = 3, 4, \dots$$

26.2.50

$$h_1(x) = \frac{1}{6} He_2(x)$$

$$h_2(x) = \frac{1}{24} He_3(x)$$

$$h_{11}(x) = -\frac{1}{36} [2He_3(x) + He_1(x)]$$

$$h_3(x) = \frac{1}{120} [He_4(x)]$$

$$h_{12}(x) = -\frac{1}{24} [He_4(x) + He_2(x)]$$

$$h_{111}(x) = \frac{1}{324} [12He_4(x) + 19He_2(x)]$$

$$h_4(x) = \frac{1}{720} He_5(x)$$

$$h_{22}(x) = -\frac{1}{384} [3He_5(x) + 6He_3(x) + 2He_1(x)]$$

$$h_{13}(x) = -\frac{1}{180} [2He_5(x) + 3He_3(x)]$$

$$h_{112}(x) = \frac{1}{288} [14He_5(x) + 37He_3(x) + 8He_1(x)]$$

$$h_{1111}(x) = -\frac{1}{7776} [252He_5(x) + 832He_3(x) + 227He_1(x)]$$

Terms in brackets in 26.2.49 are terms of the same order with respect to  $n$ . The  $He_n(x)$  are the Hermite polynomials. (See chapter 22.)

26.2.51 
$$He_n(x) = (-1)^n \frac{Z^{(n)}(x)}{Z(x)} = n! \sum_{m=0}^{\lfloor \frac{n}{2} \rfloor} \frac{(-1)^m}{2^m m! (n-2m)!} x^{n-2m}$$

In the following auxiliary table, the polynomial functions  $h_1(x), h_2(x) \dots h_{1111}(x)$  are tabulated for

$p = .25, .1, .05, .025, .01, .005, .0025, .001, .0005.$

Auxiliary coefficients<sup>a</sup> for use with Cornish-Fisher asymptotic expansion. 26.2.49

|               | p       |         |         |         |         |         |          |          |          |  |
|---------------|---------|---------|---------|---------|---------|---------|----------|----------|----------|--|
|               | .25     | .10     | .05     | .025    | .01     | .005    | .0025    | .001     | .0005    |  |
| $x$           | .67449  | 1.28155 | 1.64485 | 1.95996 | 2.32635 | 2.57583 | 2.80703  | 3.09022  | 3.29053  |  |
| $h_1(x)$      | -.09084 | .10706  | .28426  | .47358  | .73532  | .93915  | 1.14857  | 1.42491  | 1.63793  |  |
| $h_2(x)$      | -.07153 | -.07249 | -.02018 | .06872  | .23379  | .39012  | .57070   | .84331   | 1.07320  |  |
| $h_3(x)$      | .07663  | .06106  | -.01878 | -.14607 | -.37634 | -.59171 | -.83890  | -1.21025 | -1.52234 |  |
| $h_4(x)$      | .00398  | -.03464 | -.04928 | -.04410 | -.00152 | .06010  | .14841   | .30746   | .46059   |  |
| $h_5(x)$      | .00282  | .14644  | .17532  | .10210  | -.17621 | -.53531 | -1.02868 | -1.89355 | -2.71243 |  |
| $h_{111}(x)$  | -.01428 | -.11629 | -.11900 | -.02937 | .25195  | .59757  | 1.06301  | 1.86787  | 2.62337  |  |
| $h_6(x)$      | .00998  | .00227  | -.01082 | -.02357 | -.03176 | -.02621 | -.00666  | -.04591  | .10950   |  |
| $h_7(x)$      | -.03285 | .00776  | .05985  | .09659  | .07888  | -.01226 | -.19116  | -.59060  | -1.03555 |  |
| $h_8(x)$      | -.05126 | .01086  | .09462  | .16106  | .16058  | .05366  | -.17498  | -.70464  | -1.30531 |  |
| $h_{112}(x)$  | .14764  | -.10858 | -.39517 | -.55856 | -.32621 | .35696  | 1.60445  | 4.29304  | 7.23307  |  |
| $h_{1111}(x)$ | -.06898 | .09585  | .25623  | .31624  | .07286  | -.46534 | -1.39199 | -3.32708 | -5.40702 |  |

<sup>a</sup> From R. A. Fisher, Contributions to mathematical statistics, Paper 30 (with E. A. Cornish) Extrait de la Revue de l'Institut International de Statistique 4, 1-14 (1937) (with permission).

26.3. Bivariate Normal Probability Function

26.3.1

$$g(x, y, \rho) = [2\pi\sqrt{1-\rho^2}]^{-1} \exp\left\{-\frac{1}{2}\left(\frac{x^2 - 2\rho xy + y^2}{1-\rho^2}\right)\right\}$$

26.3.2 
$$g(x, y, \rho) = (1-\rho^2)^{-1/2} Z(x)Z\left(\frac{y-\rho x}{\sqrt{1-\rho^2}}\right)$$

26.3.3

$$L(h, k, \rho) = \int_h^\infty dx \int_k^\infty g(x, y, \rho) dy$$

$$= \int_h^\infty Z(x) dx \int_w^\infty Z(w) dw, \quad w = \left(\frac{k - \rho x}{\sqrt{1 - \rho^2}}\right)$$

26.3.4 
$$L(-h, -k, \rho) = \int_{-\infty}^h dx \int_{-\infty}^k g(x, y, \rho) dy$$

26.3.5 
$$L(-h, k, -\rho) = \int_{-\infty}^h dx \int_k^\infty g(x, y, \rho) dy$$

26.3.6 
$$L(h, -k, -\rho) = \int_h^\infty dx \int_{-\infty}^k g(x, y, \rho) dy$$

26.3.7 
$$L(h, k, \rho) = L(k, h, \rho)$$

26.3.8 
$$L(-h, k, \rho) + L(h, k, -\rho) = Q(k)$$

26.3.9 
$$L(-h, -k, \rho) - L(h, k, \rho) = P(k) - Q(h)$$

26.3.10

\* 
$$2[L(h, k, \rho) + L(h, k, -\rho) + P(h) - Q(k)] - 1$$

$$= \int_{-h}^h dx \int_{-k}^k g(x, y, \rho) dy$$

Probability Function With Means  $m_x, m_y$ , Variances  $\sigma_x^2, \sigma_y^2$ , and Correlation  $\rho$

The random variables  $X, Y$  are said to be distributed as a bivariate Normal distribution if

means and variances ( $m_x, m_y$ ) and ( $\sigma_x^2, \sigma_y^2$ ) and correlation  $\rho$  if the joint probability that  $X$  is less than or equal to  $h$  and  $Y$  less than or equal to  $k$  is given by

26.3.11

$$Pr\{X \leq h, Y \leq k\} = \frac{1}{\sigma_x \sigma_y} \int_{-\infty}^{\frac{h-m_x}{\sigma_x}} \int_{-\infty}^{\frac{k-m_y}{\sigma_y}} g(s, t, \rho) ds dt$$

$$= L\left(-\left(\frac{h-m_x}{\sigma_x}\right), -\left(\frac{k-m_y}{\sigma_y}\right), \rho\right)$$

The probability density function is

26.3.12

$$\frac{1}{2\pi\sigma_x\sigma_y\sqrt{1-\rho^2}} \exp\left\{-\frac{Q}{2(1-\rho^2)}\right\} = \frac{1}{\sigma_x\sigma_y} g\left(\frac{x-m_x}{\sigma_x}, \frac{y-m_y}{\sigma_y}, \rho\right)$$

where

$$Q = \frac{(x-m_x)^2}{\sigma_x^2} - \frac{2\rho(x-m_x)(y-m_y)}{\sigma_x\sigma_y} + \frac{(y-m_y)^2}{\sigma_y^2}$$

Circular Normal Probability Density Function

26.3.13

$$\frac{1}{\sigma^2} g\left(\frac{x-m_x}{\sigma}, \frac{y-m_y}{\sigma}, 0\right) =$$

$$\frac{1}{2\pi} \exp\left\{-\frac{(x-m_x)^2 + (y-m_y)^2}{2\sigma^2}\right\}$$

Special Values of  $L(h, k, \rho)$

- 26.3.14  $L(h, k, 0) = Q(h)Q(k)$
- 26.3.15  $L(h, k, -1) = 0 \quad (h+k \geq 0)$
- 26.3.16  $L(h, k, -1) = P(h) - Q(k) \quad (h+k \leq 0)$
- 26.3.17  $L(h, k, 1) = Q(h) \quad (k \leq h)$
- 26.3.18  $L(h, k, 1) = Q(k) \quad (k \geq h)$
- 26.3.19  $L(0, 0, \rho) = \frac{1}{4} + \frac{\arcsin \rho}{2\pi}$

$L(h, k, \rho)$  as a Function of  $L(h, 0, \rho)$

26.3.20

$$L(h, k, \rho) = L\left(h, 0, \frac{(\rho h - k)(\operatorname{sgn} h)}{\sqrt{h^2 - 2\rho hk + k^2}}\right) + L\left(k, 0, \frac{(\rho k - h)(\operatorname{sgn} k)}{\sqrt{h^2 - 2\rho hk + k^2}}\right)$$

$$- \begin{cases} 0 & \text{if } hk > 0 \text{ or } hk = 0 \\ & \text{and } h+k \geq 0 \\ \frac{1}{2} & \text{otherwise} \end{cases}$$

where  $\operatorname{sgn} h = 1$  if  $h \geq 0$  and  $\operatorname{sgn} h = -1$  if  $h < 0$ .

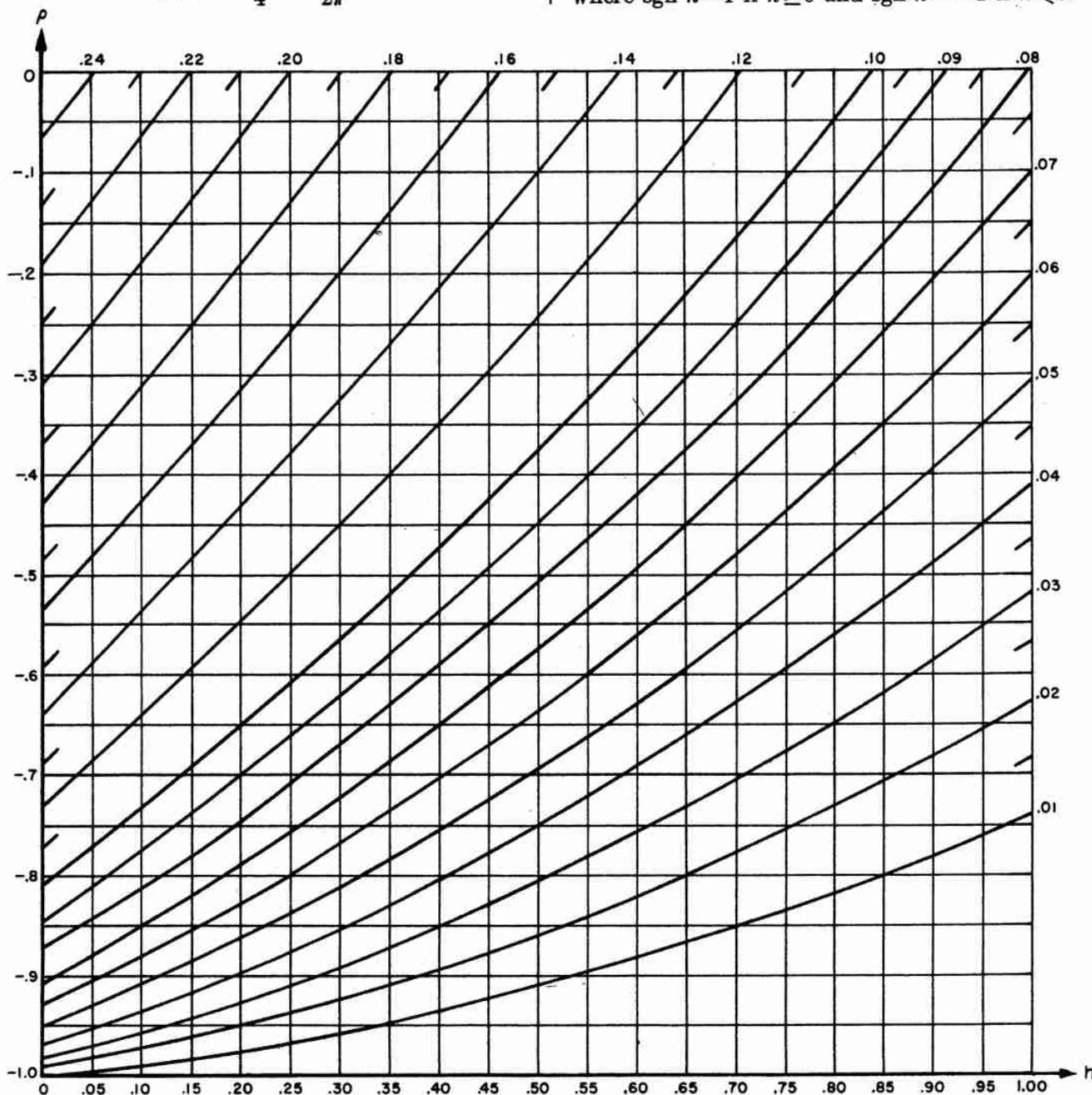

FIGURE 26.2.  $L(h, 0, \rho)$  for  $0 \leq h \leq 1$  and  $-1 \leq \rho \leq 0$ .

Values for  $h < 0$  can be obtained using  $L(h, 0, -\rho) = \frac{1}{2} - L(-h, 0, \rho)$ .



**Integral Over an Ellipse With Center at  $(m_x, m_y)$**

26.3.21

$$\iint_A (\sigma_x \sigma_y)^{-1} g\left(\frac{x-m_x}{\sigma_x}, \frac{y-m_y}{\sigma_y}, \rho\right) dx dy = 1 - e^{-a^2/2}$$

where  $A$  is the area enclosed by the ellipse

$$\left(\frac{x-m_x}{\sigma_x}\right)^2 - \frac{2\rho(x-m_x)(y-m_y)}{\sigma_x \sigma_y} + \left(\frac{y-m_y}{\sigma_y}\right)^2 = a^2(1-\rho^2)$$

**Integral Over an Arbitrary Region**

26.3.22

$$\iint_{A(x,y)} (\sigma_x \sigma_y)^{-1} g\left(\frac{x-m_x}{\sigma_x}, \frac{y-m_y}{\sigma_y}, \rho\right) dx dy = \iint_{A^*(s,t)} g(s, t, \rho) ds dt$$

where  $A^*(s, t)$  is the transformed region obtained from the transformation

$$s = \frac{1}{\sqrt{2+2\rho}} \left(\frac{x-m_x}{\sigma_x} + \frac{y-m_y}{\sigma_y}\right)$$

$$t = \frac{-1}{\sqrt{2-2\rho}} \left(\frac{x-m_x}{\sigma_x} - \frac{y-m_y}{\sigma_y}\right)$$

**Integral of the Circular Normal Probability Function With Parameters  $m_x=m_y=0, \sigma=1$  Over the Triangle Bounded by  $y=0, y=ax, x=h$**

26.3.23

$$V(h, ah) = \frac{1}{2\pi} \int_0^h \int_0^{ax} e^{-\frac{1}{2}(x^2+y^2)} dx dy$$

$$= \frac{1}{4} + L(h, 0, \rho) - L(0, 0, \rho) - \frac{1}{2} Q(h)$$

where

$$\rho = -\frac{a}{\sqrt{1+a^2}}$$

**Integral of Circular Normal Distribution Over an Offset Circle With Radius  $R\sigma$  and Center a Distance  $r\sigma$  From  $(m_x, m_y)$**

26.3.24

$$\int_A \int \sigma^{-2} g\left(\frac{x-m_x}{\sigma}, \frac{y-m_y}{\sigma}, 0\right) dx dy = P(R^2|2, r^2)$$

where  $P(R^2|2, r^2)$  is the c.d.f. of the non-central  $\chi^2$  distribution (see 26.4.25) with  $\nu=2$  degrees of freedom and noncentrality parameter  $r^2$ .

**Approximation to  $P(R^2|2, r^2)$**

26.3.25

|   |                  |
|---|------------------|
| <i>Approximation</i>                          | <i>Condition</i> |
| $\frac{2R^2}{4+R^2} \exp -\frac{2r^2}{4+R^2}$ | $R < 1$          |

26.3.26  $P(x_1)$

$R > 1$

26.3.27  $P(x_2)$

$R > 5$

$$x_1 = \frac{[R^2/(2+r^2)]^{1/3} - \left[1 - \frac{2}{9} \frac{2+2r^2}{(2+r^2)^2}\right]}{\left[\frac{2}{9} \frac{2+2r^2}{(2+r^2)^2}\right]^{1/2}}$$

$$x_2 = R - \sqrt{r^2 - 1} \quad R, r \text{ both large} \quad *$$

**Inequality**

26.3.28

$$Q(h) - \frac{1-\rho^2}{\rho h - k} Z(k) \left[ Q\left(\frac{h-\rho k}{\sqrt{1-\rho^2}}\right) \right] < L(h, k, \rho) < Q(h)$$

where

$$\rho h - k > 0, \quad 0 < \rho < 1.$$

**Series Expansion**

26.3.29

$$L(h, k, \rho) = Q(h) Q(k) + \sum_{n=0}^{\infty} \frac{Z^{(n)}(h) Z^{(n)}(k)}{(n+1)!} \rho^{n+1}$$

**26.4. Chi-Square Probability Function**

26.4.1

$$P(\chi^2|\nu) = \left[ 2^{\nu/2} \Gamma\left(\frac{\nu}{2}\right) \right]^{-1} \int_0^{\chi^2} (t)^{\frac{\nu}{2}-1} e^{-\frac{t}{2}} dt$$

$(0 \leq \chi^2 < \infty)$

26.4.2

$$Q(\chi^2|\nu) = 1 - P(\chi^2|\nu)$$

$(0 \leq \chi^2 < \infty)$

$$= \left[ 2^{\nu/2} \Gamma\left(\frac{\nu}{2}\right) \right]^{-1} \int_{\chi^2}^{\infty} (t)^{\frac{\nu}{2}-1} e^{-\frac{t}{2}} dt$$

**Relation to Normal Distribution**

Let  $X_1, X_2, \dots, X_n$  be independent and identically distributed random variables each following a normal distribution with mean zero and unit variance. Then  $X^2 = \sum_{i=1}^{\nu} X_i^2$  is said to follow the chi-square distribution with  $\nu$  degrees of freedom and the probability that  $X^2 \leq \chi^2$  is given by  $P(\chi^2|\nu)$ .

**Cumulants**

26.4.3  $\kappa_{n+1} = 2^n n! \nu \quad (n=0, 1, \dots)$

Series Expansions

26.4.4

$$Q(\chi^2|\nu) = 2Q(x) + 2Z(x) \sum_{r=1}^{\frac{\nu-1}{2}} \frac{\chi^{2r-1}}{1 \cdot 3 \cdot 5 \dots (2r-1)}$$

( $\nu$  odd) and  $\chi = \sqrt{x^2}$

26.4.5

$$Q(\chi^2|\nu) = \sqrt{2\pi}Z(x) \left\{ 1 + \sum_{r=1}^{\frac{\nu-2}{2}} \frac{\chi^{2r}}{2 \cdot 4 \dots (2r)} \right\}$$

( $\nu$  even)

26.4.6

$$P(\chi^2|\nu) = \left(\frac{1}{2} \chi^2\right)^{\nu/2} \frac{e^{-\chi^2/2}}{\Gamma\left(\frac{\nu+2}{2}\right)}$$

$$* \left\{ 1 + \sum_{r=1}^{\infty} \frac{\chi^{2r}}{(\nu+2)(\nu+4)\dots(\nu+2r)} \right\}$$

26.4.7  $P(\chi^2|\nu) = \frac{1}{\Gamma\left(\frac{\nu}{2}\right)} \sum_{n=0}^{\infty} \frac{(-1)^n (\chi^2/2)^{\frac{\nu}{2}+n}}{n! \left(\frac{\nu}{2}+n\right)}$

Recurrence and Differential Relations

26.4.8  $Q(\chi^2|\nu+2) = Q(\chi^2|\nu) + \frac{(\chi^2/2)^{\nu/2} e^{-\chi^2/2}}{\Gamma\left(\frac{\nu}{2}+1\right)}$

26.4.9  $\frac{\partial^m Q(\chi^2|\nu)}{\partial (\chi^2)^m} = \frac{1}{2^m} \sum_{j=0}^m \binom{m}{j} (-1)^{m+j} Q(\chi^2|\nu-2j)$

Continued Fraction

26.4.10  $*Q(\chi^2|\nu) = \frac{(\chi^2)^{\nu/2} e^{-\chi^2/2}}{2^{\nu/2} \Gamma(\nu/2)}$

$$\left\{ \frac{1}{\chi^2/2+} \frac{1-\nu/2}{1+} \frac{1}{\chi^2/2+} \frac{2-\nu/2}{1+} \frac{2}{\chi^2/2+} \dots \right\}$$

Asymptotic Distribution for Large  $\nu$

26.4.11  $P(\chi^2|\nu) \sim P(x)$  where  $x = \frac{\chi^2 - \nu}{\sqrt{2\nu}}$

Asymptotic Expansions for Large  $\chi^2$

26.4.12

$$Q(\chi^2|\nu) \sim \frac{(\chi^2)^{\frac{\nu-1}{2}} e^{-\chi^2/2}}{2^{\nu/2} \Gamma(\nu/2)} \sum_{j=0}^{\infty} (-1)^j \frac{\Gamma\left(1 - \frac{\nu}{2} + j\right)}{\Gamma\left(1 - \frac{\nu}{2}\right)} \frac{2^{j+1}}{(\chi^2)^j}$$

\*See page II

Approximations to the Chi-Square Distribution for Large  $\nu$

26.4.13

Approximation  $Q(\chi^2|\nu) \approx Q(x_1)$ ,  $x_1 = \sqrt{2\chi^2} - \sqrt{2\nu-1}$  Condition ( $\nu > 100$ )

26.4.14

$Q(\chi^2|\nu) \approx Q(x_2)$ ,  $x_2 = \frac{(\chi^2/\nu)^{1/3} - \left(1 - \frac{2}{9\nu}\right)}{\sqrt{2/9\nu}}$  ( $\nu > 30$ )

26.4.15

$Q(\chi^2|\nu) \approx Q(x_2 + h_\nu)$ ,  $h_\nu = \frac{60}{\nu} h_{60}$  ( $\nu > 30$ )

Values of  $h_{60}$

| $x$  | $h_{60}$ | $x$  | $h_{60}$ | $x$  | $h_{60}$ |
|------|----------|------|----------|------|----------|
| -3.5 | -.0118   | -1.0 | +.0006   | +1.5 | -.0005   |
| -3.0 | -.0067   | -.5  | .0006    | 2.0  | +.0002   |
| -2.5 | -.0033   | .0   | +.0002   | 2.5  | .0017    |
| -2.0 | -.0010   | + .5 | -.0003   | 3.0  | .0043    |
| -1.5 | +.0001   | 1.0  | -.0006   | 3.5  | .0082    |

Approximations for the Inverse Function for Large  $\nu$

If  $Q(\chi_p^2|\nu) = p$  and  $Q(x_p) = 1 - P(x_p) = p$ , then

26.4.16  $\chi_p^2 \approx \frac{1}{2} \left\{ x_p + \sqrt{2\nu-1} \right\}^2$  Condition ( $\nu > 100$ )

26.4.17  $\chi_p^2 \approx \nu \left\{ 1 - \frac{2}{9\nu} + x_p \sqrt{\frac{2}{9\nu}} \right\}^3$  ( $\nu > 30$ )

26.4.18  $\chi_p^2 \approx \nu \cdot \left\{ 1 - \frac{2}{9\nu} + (x_p - h_\nu) \sqrt{\frac{2}{9\nu}} \right\}^3$  ( $\nu > 30$ )

where  $h_\nu$  is given by 26.4.15.

Relation to Other Functions

26.4.19 Incomplete gamma function

$$\frac{\gamma(a, x)}{\Gamma(a)} = P(\chi^2|\nu), \quad \nu = 2a, \chi^2 = 2x$$

$$\frac{\Gamma(a, x)}{\Gamma(a)} = Q(\chi^2|\nu)$$

26.4.20 Pearson's incomplete gamma function

$$I(u, p) = \frac{1}{\Gamma(p+1)} \int_0^{u\sqrt{p+1}} t^p e^{-t} dt = P(\chi^2|\nu)$$

$$\nu = 2(p+1), \chi^2 = 2u\sqrt{p+1}$$

26.4.21 Poisson distribution

$$Q(\chi^2|\nu) = \sum_{j=0}^{c-1} e^{-m} \frac{m^j}{j!}, \quad c = \frac{\nu}{2}, m = \frac{\chi^2}{2}, (\nu \text{ even})$$

$$Q(\chi^2|\nu) - Q(\chi^2|\nu-2) = e^{-m} \frac{m^{c-1}}{(c-1)!}$$

26.4.22 Pearson Type III

$$\left[\frac{ab}{e}\right]^{ab} \int_{-a}^x \left(1+\frac{t}{a}\right)^{ab} e^{-bt} dt = P(\chi^2|\nu)$$

$$\nu = 2ab + 2, \chi^2 = 2b(x+a)$$

26.4.23 Incomplete moments of Normal distribution

$$\int_0^x t^n Z(t) dt = \begin{cases} (n-1)!! \frac{P(\chi^2|\nu)}{2} & (n \text{ even}) \\ \frac{(n-1)!!}{\sqrt{2\pi}} P(\chi^2|\nu) & (n \text{ odd}) \end{cases}$$

$$\chi^2 = x^2, \nu = n+1$$

26.4.24 Generalized Laguerre Polynomials

$$n! L_n^{(\alpha)}(x) = \frac{\sum_{j=0}^{n+1} (-1)^{n+j} \binom{n+1}{j} Q(\chi^2|\nu+2-2j)}{2^n [Q(\chi^2|\nu+2) - Q(\chi^2|\nu)]}$$

$$x = \chi^2/2, \alpha = \nu/2$$

Non-Central  $\chi^2$  Distribution Function

26.4.25

$$P(\chi'^2|\nu, \lambda) = \sum_{j=0}^{\infty} e^{-\lambda/2} \frac{(\lambda/2)^j}{j!} P(\chi'^2|\nu+2j)$$

where  $\lambda \geq 0$  is termed the non-centrality parameter.

Relation of Non-Central  $\chi^2$  Distribution With  $\nu=2$  to the Integral of Circular Normal Distribution ( $\sigma^2=1$ ) Over an Offset Circle Having Radius  $R$  and Center a Distance  $r = \sqrt{\lambda}$  From the Origin. (See 26.3.24-26.3.27.)

26.4.26

$$\iint_A g(x, y, 0) dx dy = P(\chi^2 = R^2|\nu=2, \lambda)$$

$$= 1 - \sum_{j=0}^{\infty} \frac{e^{-\lambda/2} \lambda^j}{2^j j!} Q(R^2|2+2j)$$

Approximations to the Non-Central  $\chi^2$  Distribution

$$a = \nu + \lambda \quad b = \frac{\lambda}{\nu + \lambda}$$

Approximating Function

Approximation

26.4.27  $\chi^2$  distribution  $P(\chi'^2|\nu, \lambda) \approx P\left(\frac{\chi^2}{1+b} \middle| \nu^*\right), \quad \nu^* = \frac{a}{1+b}$

26.4.28 Normal distribution  $P(\chi'^2|\nu, \lambda) \approx P(x), \quad x = \frac{(\chi'^2/a)^{1/3} - \left[1 - \frac{2}{9} \left(\frac{1+b}{a}\right)\right]}{\sqrt{\frac{2}{9} \left(\frac{1+b}{a}\right)}}$

26.4.29 Normal distribution  $P(\chi'^2|\nu, \lambda) \approx P(x), \quad x = \left[\frac{2\chi'^2}{1+b}\right]^{1/2} - \left[\frac{2a}{1+b} - 1\right]^{1/2}$

Approximations to the Inverse Function of Non-Central  $\chi^2$  Distribution

If  $Q(\chi_p'^2|\nu, \lambda) = p, Q(\chi_p'^2|\nu^*) = p,$  and  $Q(x_p) = p$  then

Approximating Variable

Approximation to the Inverse Function

26.4.30  $\chi^2 \quad \chi_p'^2 \approx (1+b)\chi_p^2$

26.4.31 Normal  $\chi_p'^2 \approx \frac{1+b}{2} \left[ x_p + \sqrt{\frac{2a}{1+b} - 1} \right]^2$

26.4.32 Normal  $\chi_p'^2 \approx a \left[ x_p \sqrt{\frac{2(1+b)}{a}} + 1 - \frac{2}{9} \left(\frac{1+b}{a}\right) \right]^3$

**Properties of Chi-Square, Non-Central Chi-Square, and Related Quantities**

$$a = \nu + \lambda \quad b = \frac{\lambda}{\nu + \lambda}$$

$$\psi(z) = \frac{d}{dz} \ln \Gamma(z), \quad \psi'(z) = \frac{d^2}{dz^2} \ln \Gamma(z)$$

| Variable                            | Mean  | Variance  | Coefficient of skewness ( $\gamma_1$ )   | Coefficient of excess ( $\gamma_2$ )   |
|-------------------------------------|---|---|--|--|
| <b>26.4.33</b> $\chi^2$             | $\nu$   | $2\nu$  | $\frac{2^{3/2}}{\sqrt{\nu}}$   | $12\nu^{-1}$   |
| <b>26.4.34</b> $\sqrt{2\chi^2}$     | $(2\nu-1)^{1/2} \{1 + [16\nu(\nu-1)]^{-1}\} + O(\nu^{-1/2})$  | $1 - \frac{1}{4\nu} - \frac{1}{8\nu^2} + \frac{5}{64\nu^3} - O(\nu^{-4})$                                     | $\frac{1}{\sqrt{2\nu}} \left[ 1 + \frac{5}{8\nu} - \frac{1}{128\nu^2} \right] + O(\nu^{-3/2})$   | $\frac{3}{2^2} \frac{1}{\nu^2} \left[ 1 + \frac{3}{2\nu} \right] + O(\nu^{-3})$  |
| <b>26.4.35</b> $(\chi^2/\nu)^{1/2}$ | $1 - \frac{2}{3^2\nu} + \frac{80}{3^2\nu^2} + O(\nu^{-3})$  | $\frac{2}{3^2\nu} - \frac{104}{3^2\nu^2} + O(\nu^{-3})$   | $\frac{2^{7/2}}{3^2\nu^{3/2}} \left[ 1 + \frac{8}{3^2\nu} \right] + O(\nu^{-5/2})$   | $-\frac{4}{9\nu} \left[ 1 + \frac{16}{9\nu} \right] + O(\nu^{-2})$   |
| <b>26.4.36</b> $\ln(\chi^2/\nu)$    | $\psi\left(\frac{\nu}{2}\right) - \ln\left(\frac{\nu}{2}\right) - \frac{1}{\nu} - \frac{1}{3\nu^2} + O(\nu^{-3})$ | $\psi'\left(\frac{\nu}{2}\right) = \frac{2}{\nu-1} \left[ 1 - \frac{1}{3(\nu-1)^2} \right] + O((\nu-1)^{-3})$ | $\frac{\psi''\left(\frac{\nu}{2}\right)}{\psi'\left(\frac{\nu}{2}\right)^{3/2}} = -\sqrt{\frac{2}{\nu-1}} \left[ 1 - \frac{1}{2(\nu-1)^2} \right] + O((\nu-1)^{-3/2})$ | $\frac{\psi^{(3)}\left(\frac{\nu}{2}\right)}{\psi'\left(\frac{\nu}{2}\right)^3} = \frac{4}{\nu-1} \left[ 1 + \frac{4}{3(\nu-1)^2} \right] + O((\nu-1)^{-3})$ |
| <b>26.4.37</b> $\chi^2$             | $a$   | $2a(1+b)$   | $\left(\frac{2}{1+b}\right)^{3/2} (1+2b)a^{-3/2}$  | $\frac{12(1+3b)}{a(1+b)^3}$  |
| <b>26.4.38</b> $\sqrt{2\chi^2}$     | $[2a - (1+b)]^{1/2} + O(a^{-1/2})$  | $(1+b) - \frac{a^{-1}}{4} [8b + (1+b)(1-7b)] + O(a^{-2})$   | $\frac{a^{-3/2}(1-b)(1+3b)}{2^{3/2}(1+b)^{3/2}} + O(a^{-1})$   | $\frac{3b(b+2)}{(1+b)^3 a^3} + O(a^{-2})$  |
| <b>26.4.39</b> $(\chi^2/a)^{1/2}$   | $1 - \frac{2}{3^2} \frac{1+b}{a} - \frac{40}{3^4} \frac{b^2}{a^2} + O(a^{-3})$                                    | $\frac{2}{9} a^{-1}(1+b) + \frac{16}{27} a^{-2} b^2 + O(a^{-3})$  | $\left(\frac{2}{1+b}\right)^{3/2} b^2 a^{-3/2} + O(a^{-1/2})$  | $\frac{4(1+3b+12b^2-44b^3)}{3^2 a(1+b)^3} - O(a^{-2})$   |

## 26.5. Incomplete Beta Function

## 26.5.1

$$I_x(a, b) = \frac{1}{B(a, b)} \int_0^x t^{a-1} (1-t)^{b-1} dt \quad (0 \leq x \leq 1)$$

## 26.5.2

$$I_x(a, b) = 1 - I_{1-x}(b, a)$$

## Relation to the Chi-Square Distribution

If  $X_1^2$  and  $X_2^2$  are independent random variables following chi-square distributions 26.4.1 with  $\nu_1$  and  $\nu_2$  degrees of freedom respectively, then  $\frac{X_1^2}{X_1^2 + X_2^2}$  is said to follow a beta distribution with  $\nu_1$  and  $\nu_2$  degrees of freedom and has the distribution function

## 26.5.3

$$P\left\{\frac{X_1^2}{X_1^2 + X_2^2} \leq x\right\} = \frac{1}{B(a, b)} \int_0^x t^{a-1} (1-t)^{b-1} dt \\ = I_x(a, b) \quad a = \frac{\nu_1}{2}, b = \frac{\nu_2}{2}$$

Series Expansions ( $0 < x < 1$ )

## 26.5.4

$$* I_x(a, b) = \frac{x^a (1-x)^b}{a B(a, b)} \left\{ 1 + \sum_{n=0}^{\infty} \frac{B(a+1, n+1)}{B(a+b, n+1)} x^{n+1} \right\}$$

## 26.5.5

$$I_x(a, b) = \frac{x^a (1-x)^{b-1}}{a B(a, b)} \\ \left\{ 1 + \sum_{n=0}^{\infty} \frac{B(a+1, n+1)}{B(b-n-1, n+1)} \left(\frac{x}{1-x}\right)^{n+1} \right\} \\ = \frac{x^a (1-x)^{b-1}}{a B(a, b)} \\ \left\{ 1 + \sum_{n=0}^{s-2} \frac{B(a+1, n+1)}{B(b-n-1, n+1)} \left(\frac{x}{1-x}\right)^{n+1} \right\} \\ + I_x(a+s, b-s)$$

## 26.5.6

$$1 - I_x(a, b) = I_{1-x}(b, a) \\ = \frac{(1-x)^b}{B(a, b)} \sum_{i=0}^{a-1} (-1)^i \binom{a-1}{i} \frac{(1-x)^i}{b+i} \quad (\text{integer } a)$$

## 26.5.7

$$1 - I_x(a, b) = I_{1-x}(b, a) \\ = (1-x)^{a+b-1} \sum_{i=0}^{a-1} \binom{a+b-1}{i} \left(\frac{x}{1-x}\right)^i \quad (\text{integer } a)$$

## Continued Fractions

## 26.5.8

$$I_x(a, b) = \frac{x^a (1-x)^b}{a B(a, b)} \left\{ \frac{1}{1+} \frac{d_1}{1+} \frac{d_2}{1+} \dots \right\} *$$

$$d_{2m+1} = -\frac{(a+m)(a+b+m)}{(a+2m)(a+2m+1)} x$$

$$d_{2m} = \frac{m(b-m)}{(a+2m-1)(a+2m)} x$$

Best results are obtained when  $x < \frac{a-1}{a+b-2}$ .

Also the  $4m$  and  $4m+1$  convergents are less than  $I_x(a, b)$  and the  $4m+2$ ,  $4m+3$  convergents are greater than  $I_x(a, b)$ .

## 26.5.9

$$I_x(a, b) = \frac{x^a (1-x)^{b-1}}{a B(a, b)} \left[ \frac{e_1}{1+} \frac{e_2}{1+} \frac{e_3}{1+} \dots \right]$$

$$* \quad x < 1 \quad e_i = 1$$

$$e_{2m} = -\frac{(a+m-1)(b-m)}{(a+2m-2)(a+2m-1)} \frac{x}{1-x}$$

$$e_{2m+1} = \frac{m(a+b-1+m)}{(a+2m-1)(a+2m)} \frac{x}{1-x}$$

## Recurrence Relations

## 26.5.10

$$I_x(a, b) = x I_x(a-1, b) + (1-x) I_x(a, b-1)$$

## 26.5.11

$$I_x(a, b) = \frac{1}{x} \{ I_x(a+1, b) - (1-x) I_x(a+1, b-1) \}$$

## 26.5.12

$$\left[ I_x(a, b) \right] = \frac{1}{a(1-x) + b} \{ b I_x(a, b+1) \\ + a(1-x) I_x(a+1, b-1) \} *$$

## 26.5.13

$$I_x(a, b) = \frac{1}{a+b} \{ a I_x(a+1, b) + b I_x(a, b+1) \}$$

## 26.5.14

$$I_x(a, a) = \frac{1}{2} I_{1-x'} \left( a, \frac{1}{2} \right), \quad x' = 4 \left( x - \frac{1}{2} \right)^2 \left[ x \leq \frac{1}{2} \right]$$

## 26.5.15

$$I_x(a, b) = \frac{\Gamma(a+b)}{\Gamma(a+1)\Gamma(b)} x^a (1-x)^{b-1} + I_x(a+1, b-1)$$

## 26.5.16

$$I_x(a, b) = \frac{\Gamma(a+b)}{\Gamma(a+1)\Gamma(b)} x^a (1-x)^b + I_x(a+1, b)$$

\*See page 11.

Asymptotic Expansions

26.5.17

$$1 - I_x(a, b) = I_{1-x}(b, a) \sim \frac{\Gamma(b, y)}{\Gamma(b)} - \frac{1}{24N^2} \left\{ \frac{y^3 e^{-y}}{(b-2)!} (b+1+y) \right\} + \frac{1}{5760N^4} \left\{ \frac{y^5 e^{-y}}{(b-2)!} [(b-3)(b-2)(5b+7)(b+1+y) - (5b-7)(b+3+y)y^2] \right\}$$

$$y = -N \ln x, \quad N = a + \frac{b}{2} - \frac{1}{2}$$

26.5.18

$$I_x(a, b) \sim \frac{\Gamma(a, w)}{\Gamma(a)} + \frac{e^{-w} w^a}{\Gamma(a)} \left\{ \frac{(a-1-w)}{2b} + \frac{1}{(2b)^2} \left( \frac{a^3}{2} - \frac{5}{3} a^2 + \frac{3}{2} a - \frac{1}{3} - w \left[ \frac{3}{2} a^2 - \frac{11}{6} a + \frac{1}{3} \right] + w^2 \left( \frac{3}{2} a - \frac{1}{6} \right) - \frac{1}{2} w^3 \right) \right\}$$

$$w = b \left( \frac{x}{1-x} \right)$$

26.5.19

$$I_x(a, b) \sim P(y) - Z(y) \left[ a_1 + \frac{a_2(y-a_1)}{1+a_2} + \frac{a_3(1+y^2/2)}{1+a_2} + \dots \right]$$

$$a_1 = \frac{2}{3} (b-a) [(a+b-2)(a-1)(b-1)]^{-1/2}$$

$$a_2 = \frac{1}{12} \left[ \frac{1}{a-1} + \frac{1}{b-1} - \frac{13}{a+b-1} \right]$$

$$a_3 = -\frac{8}{15} \left[ a_1 \left( a_2 + \frac{3}{a+b-2} \right) \right]$$

$$y^2 = 2 \left[ (a+b-1) \ln \frac{a+b-1}{a+b-2} + (a-1) \ln \frac{a-1}{(a+b-1)x} + (b-1) \ln \frac{b-1}{(a+b-1)(1-x)} \right]$$

and  $y$  is taken negative when  $x < \frac{a-1}{a+b-2}$

Approximations

26.5.20 If  $(a+b-1)(1-x) \leq 8$

$$I_x(a, b) = Q(\chi^2 | \nu) + \epsilon, \quad |\epsilon| < 5 \times 10^{-3} \text{ if } a+b > 6$$

$$\chi^2 = (a+b-1)(1-x)(3-x) - (1-x)(b-1), \quad \nu = 2b$$

26.5.21 If  $(a+b-1)(1-x) \geq 8$

$$I_x(a, b) = P(y) + \epsilon, \quad |\epsilon| < 5 \times 10^{-3} \text{ if } a+b > 6$$

$$y = \frac{3 \left[ w_1 \left( 1 - \frac{1}{9b} \right) - w_2 \left( 1 - \frac{1}{9a} \right) \right]}{\left[ \frac{w_1^2}{b} + \frac{w_2^2}{a} \right]^{1/2}}, \quad w_1 = (bx)^{1/3}, \quad w_2 = [a(1-x)]^{1/3}$$

Approximation to the Inverse Function

26.5.22 If  $I_{x_p}(a, b) = p$  and  $Q(y_p) = p$  then

$$x_p \approx \frac{a}{a + b e^{2w}}$$

$$w = \frac{y_p(h+\lambda)^{1/2}}{h} - \left( \frac{1}{2b-1} - \frac{1}{2a-1} \right) \left( \lambda + \frac{5}{6} - \frac{2}{3h} \right)$$

$$h = 2 \left( \frac{1}{2a-1} + \frac{1}{2b-1} \right)^{-1}, \quad \lambda = \frac{y_p^2 - 3}{6}$$

Relations to Other Functions and Distributions

| Function                                | Relation  |
|---|---|
| 26.5.23 Hypergeometric function         | $\frac{1}{B(a, b)} \frac{x^a}{a} F(a, 1-b; a+1; x) = I_x(a, b)$   |
| 26.5.24 Binomial distribution           | $\sum_{i=a}^n \binom{n}{i} p^i (1-p)^{n-i} = I_p(a, n-a+1)$   |
| 26.5.25 " "                             | $\binom{n}{a} p^a (1-p)^{n-a} = I_p(a, n-a+1) - I_p(a+1, n-a) *$  |
| 26.5.26 Negative binomial distribution  | $\sum_{i=a}^n \binom{n+s-1}{s} p^i q^s = I_q(a, n)$   |
| 26.5.27 Student's distribution          | $\frac{1}{2} [1 - A(t \nu)] = \frac{1}{2} I_x \left( \frac{\nu}{2}, \frac{1}{2} \right), \quad x = \frac{\nu}{\nu + t^2} *$ |
| 26.5.28 F-(variance-ratio) distribution | $Q(F \nu_1, \nu_2) = I_x \left( \frac{\nu_2}{2}, \frac{\nu_1}{2} \right), \quad x = \frac{\nu_2}{\nu_2 + \nu_1 F} *$        |

\*See page 11.

**26.6. F-(Variance-Ratio) Distribution Function**

**26.6.1**

$$P(F|v_1, v_2) = \frac{v_1^{v_1/2} v_2^{v_2/2}}{B\left(\frac{1}{2}v_1, \frac{1}{2}v_2\right)} \int_0^F t^{\frac{1}{2}(v_1-2)} (v_2 + v_1 t)^{-\frac{1}{2}(v_1+v_2)} dt \quad (F \geq 0)$$

**26.6.2**

$$Q(F|v_1, v_2) = 1 - P(F|v_1, v_2) = I_x\left(\frac{v_2}{2}, \frac{v_1}{2}\right)$$

where

$$x = \frac{v_2}{v_2 + v_1 F}$$

**Relation to the Chi-Square Distribution**

If  $X_1^2$  and  $X_2^2$  are independent random variables following chi-square distributions 26.4.1 with  $v_1$  and  $v_2$  degrees of freedom respectively, then the distribution of  $F = \frac{X_1^2/v_1}{X_2^2/v_2}$  is said to follow the variance ratio or *F*-distribution with  $v_1$  and  $v_2$  degrees of freedom. The corresponding distribution function is  $P(F|v_1, v_2)$ .

**Statistical Properties**

**26.6.3**

mean:  $m = \frac{v_2}{v_2 - 2} \quad (v_2 > 2)$

variance:  $\sigma^2 = \frac{2v_2^2(v_1 + v_2 - 2)}{v_1(v_2 - 2)^2(v_2 - 4)} \quad (v_2 > 4)$

third central moment:

$$\mu_3 = \left(\frac{v_2}{v_1}\right)^3 \frac{8v_1(v_1 + v_2 - 2)(2v_1 + v_2 - 2)}{(v_2 - 2)^3(v_2 - 4)(v_2 - 6)} \quad (v_2 > 6)$$

moments about the origin:

$$\mu'_n = \left(\frac{v_2}{v_1}\right)^n \frac{\Gamma\left(\frac{v_1 + 2n}{2}\right) \Gamma\left(\frac{v_1 - 2n}{2}\right)}{\Gamma\left(\frac{v_1}{2}\right) \Gamma\left(\frac{v_2}{2}\right)} \quad (v_2 > 2n)$$

characteristic function:

$$\phi(t) = E(e^{iFt}) = M\left(\frac{v_1}{2}, -\frac{v_2}{2}, -\frac{v_2}{v_1} it\right)$$

**Series Expansions**

$$x = \frac{v_2}{v_2 + v_1 F}$$

**26.6.4**

$$* Q(F|v_1, v_2) = x^{v_2/2} \left[ 1 + \frac{v_2}{2}(1-x) + \frac{v_2(v_2+2)}{2 \cdot 4}(1-x)^2 + \dots + \frac{v_2(v_2+2) \dots (v_2+v_1-4)}{2 \cdot 4 \dots (v_1-2)} (1-x)^{\frac{v_1-2}{2}} \right] \quad (v_1 \text{ even})$$

**26.6.5**

$$Q(F|v_1, v_2) = 1 - (1-x)^{v_1/2} \left[ 1 + \frac{v_1}{2}x + \frac{v_1(v_1+2)}{2 \cdot 4}x^2 + \dots + \frac{v_1(v_1+2) \dots (v_2+v_1-4)}{2 \cdot 4 \dots (v_2-2)} x^{\frac{v_2-2}{2}} \right] \quad (v_2 \text{ even})$$

**26.6.6**

$$Q(F|v_1, v_2) = x^{\frac{v_1+v_2-2}{2}} \left[ 1 + \frac{v_1+v_2-2}{2} \left(\frac{1-x}{x}\right) + \frac{(v_1+v_2-2)(v_1+v_2-4)}{2 \cdot 4} \left(\frac{1-x}{x}\right)^2 + \dots + \frac{(v_1+v_2-2) \dots (v_2+2)}{2 \cdot 4 \dots (v_1-2)} \left(\frac{1-x}{x}\right)^{\frac{v_1-2}{2}} \right] \quad (v_1 \text{ even})$$

**26.6.7**

$$Q(F|v_1, v_2) = 1 - (1-x)^{\frac{v_1+v_2-2}{2}} \left[ 1 + \frac{v_1+v_2-2}{2} \left(\frac{x}{1-x}\right) + \dots + \frac{(v_1+v_2-2) \dots (v_1+2)}{2 \cdot 4 \dots (v_2-2)} \left(\frac{x}{1-x}\right)^{\frac{v_2-2}{2}} \right] \quad (v_2 \text{ even})$$

**26.6.8**

$$Q(F|v_1, v_2) = 1 - A(t|v_2) + \beta(v_1, v_2) \quad (v_1, v_2 \text{ odd})$$

$$A(t|v_2) = \begin{cases} \frac{2}{\pi} \left\{ \theta + \sin \theta \left[ \cos \theta + \frac{2}{3} \cos^3 \theta + \dots + \frac{2 \cdot 4 \dots (v_2-3)}{3 \cdot 5 \dots (v_2-2)} \cos^{v_2-2} \theta \right] \right\} & \text{for } v_2 > 1 \\ \frac{2\theta}{\pi} & \text{for } v_2 = 1 \end{cases}$$

$$\beta(v_1, v_2) = \begin{cases} \frac{2}{\sqrt{\pi}} \left(\frac{v_2-1}{2}\right)! \sin \theta \cos^{v_2} \theta \left\{ 1 + \frac{v_2+1}{3} \sin^2 \theta + \dots + \frac{(v_2+1)(v_2+3) \dots (v_1+v_2-4) \sin^{v_1-3} \theta}{3 \cdot 5 \dots (v_1-2)} \right\} & \text{for } v_2 > 1 \\ 0 & \text{for } v_1 = 1 \quad * \end{cases}$$

where

$$\theta = \arctan \sqrt{\frac{v_1}{v_2} F}$$

**Reflexive Relation**

If  $F_p(v_1, v_2)$  and  $F_{1-p}(v_2, v_1)$  satisfy

$$Q(F_p(v_1, v_2)|v_1, v_2) = p$$

$$Q(F_{1-p}(v_2, v_1)|v_2, v_1) = 1 - p$$

\* See page 947



26.6.9 then

$$F_p(\nu_1, \nu_2) = \frac{1}{F_{1-p}(\nu_2, \nu_1)}$$

Relation to Student's *t*-Distribution Function (See 26.7)

26.6.10  $Q(F|\nu_1=1, \nu_2) = 1 - A(t|\nu_2) \quad t = \sqrt{F}$

**Limiting Forms**

26.6.11

$$\lim_{\nu_1 \rightarrow \infty} Q(F|\nu_1, \nu_2) = Q(\chi^2|\nu_2), \quad \chi^2 = \nu_1 F$$

26.6.12

$$\lim_{\nu_2 \rightarrow \infty} Q(F|\nu_1, \nu_2) = P(\chi^2|\nu_2), \quad \chi^2 = \frac{\nu_2}{F}$$

**Approximations**

26.6.13

$$Q(F|\nu_1, \nu_2) \approx Q(x), \quad x = \frac{F - \frac{\nu_2}{\nu_2 - 2}}{\frac{\nu_2}{\nu_2 - 2} \sqrt{\frac{2(\nu_1 + \nu_2 - 2)}{\nu_1(\nu_2 - 4)}}}$$

( $\nu_1$  and  $\nu_2$  large)

26.6.14

$$Q(F|\nu_1, \nu_2) \approx Q(x), \quad x = \frac{\sqrt{(2\nu_2 - 1) \frac{\nu_1}{\nu_2} F - \sqrt{2\nu_1 - 1}}}{\sqrt{1 + \frac{\nu_1}{\nu_2} F}}$$

26.6.15

$$Q(F|\nu_1, \nu_2) \approx Q(x), \quad x = \frac{F^{1/3} \left(1 - \frac{2}{9\nu_2}\right) - \left(1 - \frac{2}{9\nu_1}\right)}{\sqrt{\frac{2}{9\nu_1} + F^{2/3} \frac{2}{9\nu_2}}}$$

**Approximation to the Inverse Function**

26.6.16 If  $Q(F_p|\nu_1, \nu_2) = p$ , then

$$F_p \approx e^{2w} \text{ where } w \text{ is given by 26.5.22, with } \nu_1 = 2b, \nu_2 = 2a$$

**Non-Central *F*-Distribution Function**

26.6.17

$$P(F'|\nu_1, \nu_2, \lambda) = \int_0^{F'} p(t|\nu_1, \nu_2, \lambda) dt = 1 - Q(F'|\nu_1, \nu_2, \lambda)$$

where

$$p(t|\nu_1, \nu_2, \lambda) = \sum_{j=0}^{\infty} e^{-\lambda/2} \frac{(\lambda/2)^j}{j!} \frac{t^{\frac{\nu_1+2j}{2}} \nu_2^{\nu_2/2}}{B\left(\frac{\nu_1+2j}{2}, \frac{\nu_2}{2}\right)} \times t^{\frac{\nu_1+2j-2}{2}} [\nu_2 + (\nu_1+2j)t]^{-(\nu_1+2j+\nu_2)/2}$$

and  $\lambda \geq 0$  is termed the non-centrality parameter.

**Relation of Non-Central *F*-Distribution Function to Other Functions**

*Function*

*Relation*

26.6.18 *F*-distribution

$$P(F'|\nu_1, \nu_2, \lambda) = \sum_{j=0}^{\infty} e^{-\lambda/2} \frac{(\lambda/2)^j}{j!} P(F'|\nu_1+2j, \nu_2)$$

$$P(F'|\nu_1, \nu_2, \lambda=0) = P(F'|\nu_1, \nu_2)$$

26.6.19 Non-central *t*-distribution

$$P(F'|\nu_1=1, \nu_2, \lambda) = P(t'|\nu, \delta), \quad t' = \sqrt{F'}, \nu = \nu_2, \delta = \sqrt{\lambda}$$

26.6.20 Incomplete Beta function

$$P(F'|\nu_1, \nu_2) = \sum_{j=0}^{\infty} e^{-\lambda/2} \frac{(\lambda/2)^j}{j!} I_x\left(\frac{\nu_1}{2} + j, \frac{\nu_2}{2}\right),$$

$$x = \frac{\nu_1 F'}{\nu_1 F' + \nu_2} *$$

26.6.21 Confluent hypergeometric function

$$P(F'|\nu_1, \nu_2, \lambda) = \sum_{i=0}^{\frac{\nu_2}{2}-1} \frac{2e^{-\lambda/2}}{(\nu_1 + \nu_2) B\left(\frac{\nu_1}{2} + i + 1, \frac{\nu_2}{2} - i\right)} \times$$

$$x^{\frac{\nu_1}{2}+1} (1-x)^{\frac{\nu_2}{2}-i-1} M\left(\frac{\nu_1 + \nu_2}{2}, \frac{\nu_1}{2} + i + 1, \frac{\lambda x}{2}\right)$$

$$\left(\nu_2 \text{ even and } x = \frac{\nu_2}{\nu_1 F' + \nu_2}\right)$$

\*See page II.

Series Expansion

26.6.22

$$P(F'|v_1, v_2, \lambda) = e^{-\frac{\lambda}{2}(1-x)} x^{\frac{1}{2}(\nu_1+\nu_2-2)} \sum_{i=0}^{\frac{\nu_2-1}{2}} T_i \quad (\nu_2 \text{ even})$$

where

$$T_0 = 1$$

$$T_1 = \frac{1}{2} (\nu_1 + \nu_2 - 2 + \lambda x) \frac{1-x}{x}$$

$$T_i = \frac{1-x}{2i} [(\nu_1 + \nu_2 - 2i + \lambda x) T_{i-1} + \lambda(1-x) T_{i-2}]$$

$$x = \frac{\nu_2}{\nu_1 F' + \nu_2}$$

Limiting Forms

26.6.23

$$\lim_{\nu_1 \rightarrow \infty} P(F'|v_1, v_2, \lambda) = P(\chi'^2 | \nu, \lambda), \quad \chi'^2 = \nu_1 F', \quad \nu = \nu_1$$

26.6.24

$$\lim_{\nu_1 \rightarrow \infty} P(F'|v_1, v_2, \lambda) = Q(\chi^2 | \nu), \quad \chi^2 = \frac{\nu_2(1+c^2)}{F'}$$

where  $\lambda/\nu_1 \rightarrow c^2$  as  $\nu_1 \rightarrow \infty$ .

Approximations to the Non-Central F-Distribution

26.6.25  $P(F'|v_1, v_2, \lambda) \approx P(x_1)$ , ( $\nu_1$  and  $\nu_2$  large)

where

$$x_1 = \frac{F' - \frac{\nu_2(\nu_1 + \lambda)}{\nu_1(\nu_2 - 2)}}{\frac{\nu_2}{\nu_1} \left[ \frac{2}{(\nu_2 - 2)(\nu_2 - 4)} \left\{ \frac{(\nu_1 + \lambda)^2}{\nu_2 - 2} + \nu_1 + 2\lambda \right\} \right]^{\frac{1}{2}}}$$

26.6.26

$$P(F'|v_1, v_2, \lambda) \approx P(F|v_1^*, v_2),$$

$$F = \frac{\nu_1}{\nu_1 + \lambda} F', \quad v_1^* = \frac{(\nu_1 + \lambda)^2}{\nu_1 + 2\lambda}$$

26.6.27

$$P(F'|v_1, v_2, \lambda) \approx P(x_2),$$

$$x_2 = \frac{\left[ \frac{\nu_1 F'}{\nu_1 + \lambda} \right]^{1/3} \left[ 1 - \frac{2}{9\nu_2} \right] - \left[ 1 - \frac{2(\nu_1 + 2\lambda)}{9(\nu_1 + \lambda)^2} \right]}{\left[ \frac{2}{9} \frac{\nu_1 + 2\lambda}{(\nu_1 + \lambda)^2} + \frac{2}{9\nu_2} \left( \frac{\nu_1}{\nu_1 + \lambda} F' \right)^{2/3} \right]^{\frac{1}{2}}}$$

26.7. Student's *t*-Distribution

If  $X$  is a random variable following a normal distribution with mean zero and variance unity, and  $\chi^2$  is a random variable following an independent chi-square distribution with  $\nu$  degrees of freedom, then the distribution of the ratio  $\frac{X}{\sqrt{\chi^2/\nu}}$

is called Student's *t*-distribution with  $\nu$  degrees of freedom. The probability that  $\frac{X}{\sqrt{\chi^2/\nu}}$  will be less in absolute value than a fixed constant  $t$  is

26.7.1

$$A(t|\nu) = P_r \left\{ \left| \frac{X}{\sqrt{\chi^2/\nu}} \right| \leq t \right\} \\ = \left[ \sqrt{\nu} B \left( \frac{1}{2}, \frac{\nu}{2} \right) \right]^{-1} \int_{-t}^t \left( 1 + \frac{x^2}{\nu} \right)^{-\frac{\nu+1}{2}} dx \\ = 1 - I_x \left( \frac{\nu}{2}, \frac{1}{2} \right), \quad (0 \leq t < \infty) *$$

where

$$x = \frac{\nu}{\nu + t^2}$$

Statistical Properties

26.7.2

mean:  $m = 0$

variance:  $\sigma^2 = \frac{\nu}{\nu - 2}$  ( $\nu > 2$ )

skewness:  $\gamma_1 = 0$

excess:  $\gamma_2 = \frac{6}{\nu - 4}$  ( $\nu > 4$ )

moments:

$$\mu_{2n} = \frac{1 \cdot 3 \dots (2n-1) \nu^n}{(\nu-2)(\nu-4) \dots (\nu-2n)} \quad (\nu > 2n)$$

$$\mu_{2n+1} = 0$$

characteristic function:

$$\phi(t) = E \left[ \exp \left( it \frac{X}{\sqrt{\chi^2/\nu}} \right) \right] = \frac{\left( \frac{|t|}{2\sqrt{\nu}} \right)^{\nu/2}}{\pi \Gamma(\nu/2)} Y_{\frac{\nu}{2}} \left( \frac{|t|}{\sqrt{\nu}} \right)$$

Series Expansions

$$\left( \theta = \arctan \frac{t}{\sqrt{\nu}} \right)$$

26.7.3

$$A(t|\nu) = \begin{cases} \frac{2}{\pi} \left\{ \theta + \sin \theta \left[ \cos \theta + \frac{2}{3} \cos^3 \theta + \dots \right. \right. \\ \left. \left. + \frac{2 \cdot 4 \dots (\nu-3)}{1 \cdot 3 \dots (\nu-2)} \cos^{\nu-2} \theta \right] \right\} & * \\ \frac{2}{\pi} \theta & (\nu = 1) \end{cases} \quad (\nu > 1 \text{ and odd})$$

26.7.4

$$A(t|\nu) = \sin \theta \left\{ 1 + \frac{1}{2} \cos^2 \theta + \frac{1 \cdot 3}{2 \cdot 4} \cos^4 \theta + \dots \right. \\ \left. + \frac{1 \cdot 3 \cdot 5 \dots (\nu-3)}{2 \cdot 4 \cdot 6 \dots (\nu-2)} \cos^{\nu-2} \theta \right\} \quad (\nu \text{ even}) *$$

\*See page II.

**Asymptotic Expansion for the Inverse Function**

If  $A(t_p|\nu) = 1 - 2p$  and  $Q(x_p) = p$ , then

26.7.5

$$t_p \sim x_p + \frac{g_1(x_p)}{\nu} + \frac{g_2(x_p)}{\nu^2} + \frac{g_3(x_p)}{\nu^3} + \dots$$

$$g_1(x) = \frac{1}{4}(x^3 + x)$$

$$g_2(x) = \frac{1}{96}(5x^5 + 16x^3 + 3x)$$

$$g_3(x) = \frac{1}{384}(3x^7 + 19x^5 + 17x^3 - 15x)$$

$$g_4(x) = \frac{1}{92160}(79x^9 + 776x^7 + 1482x^5 - 1920x^3 - 945x)$$

**Limiting Distribution**

26.7.6

$$\lim_{\nu \rightarrow \infty} A(t|\nu) = \frac{1}{\sqrt{2\pi}} \int_{-t}^t e^{-x^2/2} dx = A(t)$$

**Approximation for Large Values of  $t$  and  $\nu \leq 5$**

26.7.7  $A(t|\nu) \approx 1 - 2 \left\{ \frac{a_\nu}{t^\nu} + \frac{b_\nu}{t^{\nu+1}} \right\}$

| $\nu$   | 1     | 2     | 3      | 4      | 5      |
|---------|-------|-------|--------|--------|--------|
| $a_\nu$ | .3183 | .4991 | 1.1094 | 3.0941 | 9.948  |
| $b_\nu$ | .0000 | .0518 | -.0460 | -2.756 | -14.05 |

**Approximation for Large  $\nu$**

26.7.8  $A(t|\nu) \approx 2P(x) - 1$ ,  $x = \frac{t \left(1 - \frac{1}{4\nu}\right)}{\sqrt{1 + \frac{t^2}{2\nu}}}$

**Non-Central  $t$ -Distribution**

26.7.9

$$P(t'|\nu, \delta) = \frac{1}{\sqrt{\nu} B\left(\frac{1}{2}, \frac{\nu}{2}\right)} \int_{-\infty}^{t'} \left(\frac{\nu}{\nu+x^2}\right)^{\frac{\nu+1}{2}} e^{-\frac{1}{2} \frac{\nu \delta^2}{\nu+x^2}} H_{\nu} \left(\frac{-\delta x}{\sqrt{\nu+x^2}}\right) dx$$

$$= 1 - \sum_{j=0}^{\infty} e^{-\delta^2/2} \frac{(\delta^2/2)^j}{2^j j!} I_x \left(\frac{\nu}{2}, \frac{1}{2} + j\right), \quad x = \frac{\nu}{\nu+t'^2} *$$

where  $\delta$  is termed the non-centrality parameter.

**Approximation to the Non-Central  $t$ -Distribution**

26.7.10

$$P(t'|\nu, \delta) \approx P(x) \quad \text{where } x = \frac{t' \left(1 - \frac{1}{4\nu}\right) - \delta}{\left(1 + \frac{t'^2}{2\nu}\right)^{1/2}}$$

**Numerical Methods**

**26.8. Methods of Generating Random Numbers and Their Applications <sup>9</sup>**

Random digits are digits generated by repeated independent drawings from the population 0, 1, 2, . . . , 9 where the probability of selecting any digit is one-tenth. This is equivalent to putting 10 balls, numbered from 0 to 9, into an urn and drawing one ball at a time, replacing the ball after each drawing. The recorded set of numbers forms a collection of random digits. Any group of  $n$  successive random digits is known as a *random number*.

Several lengthy tables of random digits are available (see references). However, the use of random numbers in electronic computers has resulted in a need for random numbers to be generated in a completely deterministic way. The numbers so generated are termed pseudo-random numbers. The quality of pseudo-random numbers is determined by subjecting the numbers to several statistical tests, see [26.55], [26.56]. The purpose of these statistical tests is to detect any properties of the pseudo-random numbers which are different from the (conceptual) properties of random numbers.

<sup>9</sup> The authors wish to express their appreciation to Professor J. W. Tukey who made many penetrating and helpful suggestions in this section.

Experience has shown that the congruence method is the most preferable device for generating random numbers on a computer. Let the sequence of pseudo-random numbers be denoted by  $\{X_n\}$ ,  $n=0, 1, 2, \dots$ . Then the congruence method of generating pseudo-random numbers is

$$X_{n+1} = aX_n + b \pmod{T}$$

where  $b$  and  $T$  are relatively prime. The choice of  $T$  is determined by the capacity and base of the computer;  $a$  and  $b$  are chosen so that: (1) the resulting sequence  $\{X_n\}$  possesses the desired statistical properties of random numbers, (2) the period of the sequence is as long as possible, and (3) the speed of generation is fast. A guide for choosing  $a$  and  $b$  is to make the correlation between the numbers be near zero, e.g., the correlation between  $X_n$  and  $X_{n+s}$  is

$$\rho_s = \frac{1 - 6 \frac{b_s}{T} \left(1 - \frac{b_s}{T}\right)}{a_s} + e$$

where

$$a_s = a^s \pmod{T}$$

$$b_s = (1 + a + a^2 + \dots + a^{s-1})b \pmod{T}$$

$$|e| < a_s/T$$

\*See page II.

which occur in

$$X_{n+s} = a_s X_n + b, \pmod{T}$$

When  $a$  is chosen so that  $a \approx T^{1/2}$ , the correlation  $\rho_1 \approx T^{-1/2}$ .

The sequence defined by the multiplicative congruence method will have a full period of  $T$  numbers if

- (i)  $b$  is relatively prime to  $T$
- (ii)  $a \equiv 1 \pmod{p}$  if  $p$  is a prime factor of  $T$
- (iii)  $a \equiv 1 \pmod{4}$  if 4 is a factor of  $T$ .

Consequently if  $T=2^e$ ,  $b$  need only be odd, and

$a \equiv 1 \pmod{4}$ . When  $T=10^e$ ,  $b$  need only be not divisible by 2 or 5, and  $a \equiv 1 \pmod{20}$ . The most convenient choices for  $a$  are of the form  $a=2^s+1$  (for binary computers) and  $a=10^s+1$  (for decimal computers). This results in the fastest generation of random numbers as the operations only require a shift operation plus two additions. Also any number can serve as the starting point to generate a sequence of random digits. A good summary of generating pseudo-random numbers is [26.51].

Below are listed various congruence schemes and their properties.

*Congruence methods for generating random numbers*

$$X_{n+1} = aX_n + b \pmod{T}, \text{ } T \text{ and } b \text{ relatively prime}$$

|        | $a$                                  | $b$ | $T$           | Period             | $X_0$                   | Special cases for which random numbers have passed statistical tests for randomness <sup>10</sup>   |
|--------|--------------------------------------|-----|---------------|--------------------|-------------------------|---|
| 26.8.1 | $1+t^e$                              | odd | $T=t^e$       | $t^e$              | $0 \leq X_0 < T$        | $T=2^{10}$ , $X_0$ unknown; $a=2^7+1$ , $b=1$ ; $T=2^{17}$ , $a=2^9+1$ , $b=29741\ 09625\ 8473$ , $X_0=76293\ 94531\ 25$ .  |
| 26.8.2 | $r2^s \pm 1$ ( $r$ odd, $s \geq 2$ ) | 0   | $T=t^e$       | $t^e$              | relatively prime to $T$ | $T=2^{10}$ , $2^{13}$ , $X_0=1$ ; $a=5^{11}(s=2)$<br>$T=2^{10}$ , $X_0=1$ ; $T=2^{11}$ , $X_0=1-2^{-10}$ , .5478126193; $a=5^{13}(s=2)$<br>$T=2^{10}$ , $X_0=1$ ; $a=5^{15}(s=2)$ |
| 26.8.3 | $r2^s \pm 1$ ( $r$ odd, $s \geq 2$ ) | 0   | $T=t^e \pm 1$ | (varies)           | relatively prime to $T$ | $T=2^{14}+1$ , $X_0=10,987,654,321$ ; $a=23$ ; period $\approx 10^8$<br>$T=10^4+1$ , $X_0=47,594,118$ ; $a=23$ ; period $\approx 5.8 \times 10^8$                                 |
| 26.8.4 | $7^{e+1}$                            | 0   | $T=10^e$      | $5 \cdot 10^{e-2}$ | relatively prime to $T$ | $T=10^{10}$ , $X_0=1$ ; $a=7$<br>$T=10^{11}$ , $X_0=1$ ; $a=7^{11}$   |
| 26.8.5 | $3^{e+1}$ ( $e=0, 2, 3, 4$ )         | 0   | $T=10^e$      | $5 \cdot 10^{e-2}$ | relatively prime to $T$ |   |

<sup>10</sup>  $X_0$  given is the starting point for random numbers when statistical tests were made.

When the numbers are generated using a congruence scheme, the least significant digits have short periods. Hence the entire word length cannot be used. If one desired random numbers with as many digits as possible, one would have to modify the congruence schemes. One way is to generate the numbers mod  $T \pm 1$ . This unfortunately reduces the period.

**Generation of Random Deviates**

Let  $\{X\}$  be a generated sequence of independent random numbers having the domain  $(0, T)$ . Then  $\{U\} = \{T^{-1}X\}$  is a sequence of random deviates (numbers) from a uniform distribution on the interval  $(0, 1)$ . This is usually a necessary preliminary step in the generation of random deviates having a given cumulative distribution function  $F(y)$  or probability density function  $f(y)$ . Below are summarized some general techniques

for producing arbitrary random deviates. (In what follows  $\{U\}$  will always denote a sequence of random deviates from a uniform distribution on the interval  $(0, 1)$ .)

**1. Inverse Method**

The solutions  $\{y\}$  of the equations  $\{u = F(y)\}$  form a sequence of independent random deviates with cumulative distribution function  $F(y)$ . (If  $F(y)$  has a discontinuity at  $y=y_0$ , then whenever  $u$  is such that  $F(y_0-0) < u < F(y_0)$ , select  $y_0$  as the corresponding deviate.) Generally the inverse method is not practical unless the inverse function  $y = F^{-1}(u)$  can be obtained explicitly or can be conveniently approximated.

**2. Generating a Discrete Random Variable**

Let  $Y$  be a discrete random variable with point probabilities  $p_i = Pr\{Y=y_i\}$  for  $i=1, 2, \dots$

\*See page II.

The direct way to generate  $Y$  is to generate  $\{U\}$  and put  $Y=y_i$  if

$$p_1 + p_2 + \dots + p_{i-1} < U < p_1 + p_2 + \dots + p_i.$$

However, this method requires complicated machine programs that take too long.

An alternative way due to Marsaglia [26.53] is simple, fast, and seems to be well suited to high-speed computations. Let  $p_i$  for  $i=1, 2, \dots, n$  be expressed by  $k$  decimal digits as  $p_i = .\delta_{i1}\delta_{i2} \dots \delta_{ik}$  where the  $\delta$ 's are the decimal digits. (If the domain of the random variable is infinite, it is necessary to truncate the probability distribution at  $p_n$ .) Define

$$P_0=0, P_r=10^{-r} \sum_{i=1}^n \delta_{ri} \text{ for } r=1, 2, \dots, k, \text{ and}$$

$$\Pi_s = \sum_{r=0}^s 10^r P_r, s=1, 2, \dots, k.$$

Number the computer memory locations by 0, 1, 2, ...,  $\Pi_k - 1$ . The memory locations are divided into  $k$  mutually exclusive sets such that the  $s$ th set consists of memory locations  $\Pi_{s-1}, \Pi_{s-1} + 1, \dots, \Pi_s - 1$ . The information stored in the memory locations of the  $s$ th set consists of  $y_1$  in  $\delta_{s1}$  locations,  $y_2$  in  $\delta_{s2}$  locations, ...,  $y_n$  in  $\delta_{sn}$  locations.

Denote the decimal expansion of the uniform deviates generated by the computer by  $u = .d_1d_2d_3 \dots$  and finally let  $a\{m\}$  be the contents of memory location  $m$ . Then if

$$\sum_{i=0}^{s-1} P_i \leq U < \sum_{i=0}^s P_i$$

put

$$y = a \left\{ d_1d_2 \dots d_s + \Pi_{s-1} - 10^s \sum_{i=1}^{s-1} P_i \right\}.$$

This method is perhaps the best all-around method for generating random deviates from a discrete distribution. In order to illustrate this method consider the problem of generating deviates from the binomial distribution with point probabilities

$$p_i = \binom{n}{i} p^i (1-p)^{n-i}$$

for  $n=5$  and  $p=.20$ . The point probabilities to 4 D are

| Value of Random Variable | Point Probabilities |
|--------------------------|---------------------|
| 0                        | $p_0=0.3277$        |
| 1                        | $p_1=.4096$         |
| 2                        | $p_2=.2048$         |
| 3                        | $p_3=.0512$         |
| 4                        | $p_4=.0064$         |
| 5                        | $p_5=.0003$         |

and thus  $P_0=0, P_1=.9, P_2=.07, P_3=.027, P_4=.0030$  from which  $\Pi_0=0, \Pi_1=9, \Pi_2=16, \Pi_3=43, \Pi_4=73$ . The 73 memory locations are divided into 4 mutually exclusive sets such that

| Set | Memory Locations |
|-----|------------------|
| 1   | 0, 1, ..., 8     |
| 2   | 9, 10, ..., 15   |
| 3   | 16, ..., 42      |
| 4   | 43, ..., 72      |

Among the nine memory locations of set 1, zero is stored  $\delta_{10}=3$  times, 1 is stored  $\delta_{11}=4$  times, 2 is stored  $\delta_{12}=2$  times; the seven locations of set 2 store 0  $\delta_{20}=2$  times and 3  $\delta_{23}=5$  times; etc. A summary of the memory locations is set out below:

|                   | Value of Random Variable |   |   |   |   |   |
|-------------------|--------------------------|---|---|---|---|---|
|                   | 0                        | 1 | 2 | 3 | 4 | 5 |
| Frequency (set 1) | 3                        | 4 | 2 | 0 | 0 | 0 |
| Frequency (set 2) | 2                        | 0 | 0 | 5 | 0 | 0 |
| Frequency (set 3) | 7                        | 9 | 4 | 1 | 6 | 0 |
| Frequency (set 4) | 7                        | 6 | 8 | 2 | 4 | 3 |

Then to generate the random variables if

|                       |     |                                |
|-----------------------|-----|--------------------------------|
| $0 \leq u < .9$       | put | $y = a\{d_1\}$                 |
| $.9 \leq u < .97$     |     | $y = a\{d_1d_2 - 81\}$         |
| $.97 \leq u < .997$   |     | $y = a\{d_1d_2d_3 - 954\}$     |
| $.997 \leq u < 1.000$ |     | $y = a\{d_1d_2d_3d_4 - 9927\}$ |

### 3. Generating a Continuous Random Variable

The method for generating deviates from a discrete distribution can be adapted to random variables having a continuous distribution. Let  $F(y)$  be the cumulative distribution function and assume that the domain of the random variable is  $(a, b)$  where the interval is finite. (If the domain is infinite, it must be truncated at (say) the points  $a$  and  $b$ .) Divide the interval  $(b-a)$  into  $n$  sub-intervals of length  $\Delta$  ( $n\Delta = b-a$ ) such that the boundary of the  $i$ th interval is  $(y_{i-1}, y_i)$  where  $y_i = a + i\Delta$  for  $i=0, 1, \dots, n$ . Now define a discrete distribution having domain

$$\left\{ z_i = \frac{y_i + y_{i-1}}{2} \right\}$$

with point probabilities  $p_i = F(y_i) - F(y_{i-1})$ . Finally, let  $W$  be a random variable having a uniform distribution on  $\left(-\frac{\Delta}{2}, \frac{\Delta}{2}\right)$ . This can be done by setting  $W = \Delta\left(U - \frac{1}{2}\right)$ . Then random



deviates from the distribution function  $F(y)$ , can be generated (approximately) by setting  $y = z + w = z + \Delta \left( u - \frac{1}{2} \right)$ . This is simply an approximate decomposition of the continuous random variable into the sum of a discrete and continuous random variable. The discrete variable can be generated quickly by the method described previously. The smaller the value of  $\Delta$  the better will be the approximation. Each number can be generated by using the leading digits of  $U$  to generate the discrete random variable  $Z$  and the remaining digits forming a uniformly distributed deviate having  $(0,1)$  domain.

**4. Acceptance-Rejection Methods**

In what follows the random variable  $Y$  will be assumed to have finite domain  $(a, b)$ . If the domain is infinite, it must be truncated for computational purposes at (say) the points  $a$  and  $b$ . Then the resulting random deviates will only have this truncated domain.

a) Let  $f$  be the maximum of  $f(y)$ . Then the procedure for generating random deviates is: (1) generate a pair of uniform deviates  $U_1, U_2$ ; (2) compute a point  $y = a + (b - a)u_2$  in  $(a, b)$ ; (3) if  $u_1 < f(y)/f$  accept  $y$  as the random deviate, otherwise reject the pair  $(u_1, u_2)$  and start again. The acceptance ratio of deviates actually produced is  $[(b - a)f]^{-1}$ . Hence the acceptance ratio decreases as the domain increases. One way to increase the acceptance ratio is to divide the interval  $(a, b)$  into mutually exclusive sub-intervals and then carry out the acceptance-rejection process. For this purpose let the interval  $(a, b)$  be divided into  $k$  sub-intervals such that the end points of the  $j$ th interval are  $(\xi_{j-1}, \xi_j)$  with  $\xi_0 = a, \xi_k = b$  and  $\int_{\xi_{j-1}}^{\xi_j} f(y)dy = p_j$ ; further let the maximum of  $f(y)$  in the  $j$ th interval be  $f_j$ . Then to generate random deviates from  $f(y)$ , generate  $n$  pairs of deviates  $(u_{1s}, u_{2s}) s = 1, 2, \dots, n$ . Assign  $[np_j]$  such pairs to the  $j$ th interval and compute  $y_j = \xi_{j-1} + (\xi_j - \xi_{j-1})u_{2s}$ . If  $u_{1s} < f(y_j)/f_j$  accept  $y_j$  as a deviate. The acceptance ratio of this method is

$$\sum_{j=1}^k p_j [(\xi_j - \xi_{j-1})f_j]^{-1}$$

b) Let  $F(y)$  be such that  $f(y) = f_1(y)f_2(y)$  where the domain of  $y$  is  $(a, b)$ . Let  $f_1$  and  $f_2$  be the maximum of  $f_1(y)$  and  $f_2(y)$  respectively. Then the procedure for generating random de-

viates having the probability density function  $f(y)$  is: (1) generate  $U_1, U_2, U_3$ ; (2) define  $z = a + (b - a)u_3$ ; (3) if both  $u_1 < \frac{f_1(z)}{f_1}$  and  $u_2 < \frac{f_2(z)}{f_2}$ , take  $z$  as the random deviate; otherwise take another sample of three uniform deviates. The acceptance ratio of this method is  $[(b - a)f_1f_2]^{-1}$  and can be increased by dividing  $(a, b)$  into sub-intervals as in the previous case.

c) Let the probability density function of  $Y$  be

$$f(y) = \int_{\alpha}^{\beta} g(y, t)dt, (\alpha \leq t \leq \beta), (a \leq y \leq b).$$

Let  $g$  be the maximum of  $g(y, t)$ . Then the procedure for generating random deviates having the probability density function  $f(y)$  is: (1) generate  $U_1, U_2, U_3$ ; (2) define  $s = \alpha + (\beta - \alpha)u_2$ ;  $z = a + (b - a)u_3$ ; (3) if  $u_1 < \frac{g(z, s)}{g}$ , take  $z$  as the random deviate; otherwise take another sample of three. The acceptance ratio for this method is  $[(b - a)g]^{-1}$  and can be increased by dividing the domain of  $t$  and  $y$  into sub-domains.

**5. Composition Method**

Let  $g_z(y)$  be a probability density function which depends on the parameter  $z$ ; further let  $H(z)$  be the cumulative distribution function for  $z$ . In order to generate random deviates  $Y$  having the frequency function

$$f(y) = \int_{-\infty}^{\infty} g_z(y)dH(z)$$

one draws a deviate having the cumulative distribution function  $H(z)$ ; then draws a second sample having the probability density function  $g_z(y)$ .

**6. Generation of Random Deviates From Well Known Distributions**

**a. Normal distribution**

(1) *Inverse method*: The inverse method depends on having a convenient approximation to the inverse function  $x = P^{-1}(u)$  where

$$u = (2\pi)^{-1/2} \int_{-\infty}^x e^{-t^2/2} dt.$$

Two ways of performing this operation are to (i) use 26.2.23 with  $t = \left( \ln \frac{1}{u^2} \right)^{1/2}$  or (ii) approximate  $x = P^{-1}(u)$  piecewise using Chebyshev polynomials, see [26.54].

(2) *Sum of uniform deviates*: Let  $U_1, U_2, \dots, U_n$  be a sequence of  $n$  uniform deviates. Then

$$X_n = \left( \sum_{i=1}^n U_i - \frac{n}{2} \right) \left( \frac{n}{12} \right)^{-1/2}$$

will be distributed asymptotically as a normal random deviate. When  $n=12$ , the maximum errors made in the normal deviate are  $9 \times 10^{-3}$  for  $|X| < 2$ ,  $9 \times 10^{-1}$  for  $2 < |X| < 3$ . An improvement can be made by taking a polynomial function of  $X_n$  (say)

$$X_n^* = X_n \sum_{s=0}^k a_{2s} X_n^{2s}$$

as the normal deviate where  $a_{2s}$  are suitable coefficients. These coefficients may be calculated using (say) Chebyshev polynomials or simply by making the asymptotic random deviate agree with the correct normal deviate at certain specified points. When  $n=12$ , the maximum error in the normal deviate is  $8 \times 10^{-4}$  using the coefficients

$$\begin{aligned} * a_0 &= 9.8746 & * a_6 &= (-7) - 5.102 \\ * a_2 &= (-3)3.9439 & * a_8 &= (-7)1.141 \\ * a_4 &= (-5)7.474 \end{aligned}$$

(3) *Direct method*: Generate a pair of uniform deviates  $(U_1, U_2)$ . Then

$$X_1 = (-2 \ln U_1)^{1/2} \cos 2\pi U_2,$$

$X_2 = (-2 \ln U_1)^{1/2} \sin 2\pi U_2$  will be a pair of independent normal random deviates with mean zero and unit variance. This procedure can be modified by calculating  $\cos 2\pi U$  and  $\sin 2\pi U$  using an acceptance rejection method; e.g., (1) generate  $(U_1, U_2)$ ; (2) if  $(2U_1 - 1)^2 + (2U_2 - 1)^2 \leq 1$  generate a third uniform deviate  $U_3$ , otherwise reject the pair and start over; (3) calculate  $y_1 = (-\ln u_3)^{1/2} \frac{u_1^2 - u_2^2}{u_1^2 + u_2^2}$ ,  $y_2 = \pm 2(-\ln u_3)^{1/2} \frac{u_1 u_2}{u_1^2 + u_2^2}$  ( $\pm$  random). Both  $y_1$  and  $y_2$  are the desired random deviates.

(4) *Acceptance-rejection method*: 1) Generate a pair of uniform deviates  $(U_1, U_2)$ ; 2) compute  $x = -\ln u_1$ ; 3) if  $e^{-1/2(x-1)^2} \geq u_2$  (or equivalently  $(x-1)^2 \leq -2(\ln u_2)$ ) accept  $x$ , otherwise reject the

pair and start over. The quantity will be the required normal deviate with mean zero and unit variance.

**b. Bivariate normal distribution**

Let  $\{X_1, X_2\}$  be a pair of independent normal deviates with mean zero and unit variance. Then  $\{X_1, \rho X_1 + (1 - \rho^2)^{1/2} X_2\}$  represent a pair of deviates from a bivariate normal distribution with zero means, unit variances, and correlation coefficient  $\rho$ .

**c. Exponential distribution**

(1) *Inverse method*: Since  $F(x) = e^{-x/\theta}$ ,  $X = -\theta \ln U$  will be a deviate from the exponential distribution with parameter  $\theta$ .

(2) *Acceptance-rejection method*: 1) Generate a pair of independent uniform deviates  $(U_0, U_1)$ ; 2) if  $U_1 < U_0$  generate a third value  $U_2$ ; 3) if  $U_1 + U_2 < U_0$  generate a fourth value  $U_3$ , etc.; 4) continue generating uniform deviates until an  $n$  is obtained such that  $U_1 + U_2 + \dots + U_{n-1} < U_0 < U_1 + \dots + U_n$ ; 5) if  $n$  is even reject the procedure and start a fresh trial with a new value of  $U_0$ , otherwise if  $n$  is odd take  $X = \theta U_0$  as the desired deviate; 6) in general if  $t$  is the number of trials until an acceptable sequence is obtained  $X = \theta(t + U_0)$ . The random deviates produced in this way follow an exponential distribution with parameter  $\theta$ . One can expect to generate approximately six uniform deviates for every exponential deviate.

(3) *Discrete Distribution Method*: Let  $Y$  and  $n$  be discrete random variables with point probabilities

$$\begin{aligned} * Pr\{Y=r\} &= (e-1)e^{-(r+1)} \quad r=0, 1, 2, \dots \\ Pr\{n=s\} &= [s!(e-1)]^{-1} \quad s=1, 2, 3, \dots \end{aligned}$$

Then  $X = Y + \min(U_1, U_2, \dots, U_n)$  will follow an exponential distribution. The average value of  $n$  is 1.58 so that one needs, on the average, only 1.58  $u$ 's from which the minimum is selected.

**26.9. Use and Extension of the Tables**

**Use of Probability Function Inequalities**

**Example 1.** Let  $X$  be a random variable with finite mean and variance equal to  $m$  and  $\sigma^2$ , respectively. Use the inequalities for probability functions 26.1.37, 40, 41 to place lower bounds on

$$A(t) = F(t) - F(-t) = P \left\{ \frac{|X-m|}{\sigma} \leq t \right\}$$

for  $t=1(1)4$ .

\*See page II.

| Lower bounds on $A(t) = F(t) - F(-t)$ |       |       |       | Remarks                                    |
|---------------------------------------|-------|-------|-------|--|
| $t=1$                                 | 2     | 3     | 4     |  |
| 0                                     | .7500 | .8889 | .9375 | no knowledge of $F(t)$ ; 26.1.37           |
| .5556                                 | .8889 | .9506 | .9722 | $F(t)$ is unimodal and continuous; 26.1.40 |
| 0                                     | .8182 | .9697 | .9912 | $F(t)$ is such that $\mu_4=3$ ; 26.1.41    |



It is of interest to note that the standard normal distribution is unimodal, has mean zero, unit variance  $\mu_4=3$ , is continuous, and such that

$$A(t) = P(t) - P(-t) \\ = .6827, .9545, .9973, \text{ and } .9999$$

for  $t=1, 2, 3$  and  $4$  respectively.

**Interpolation for  $P(x)$  in Table 26.1**

**Example 2.** Compute  $P(x)$  for  $x=2.576$  to fifteen decimal places using a Taylor expansion.

Writing  $x=x_0+\theta$  we have

$$P(x) = P(x_0) + Z(x_0)\theta + Z^{(1)}(x_0) \frac{\theta^2}{2!} \\ + Z^{(2)}(x_0) \frac{\theta^3}{3!} + Z^{(3)}(x_0) \frac{\theta^4}{4!} + \dots$$

Taking  $x_0=2.58$  and  $\theta=-4 \times 10^{-3}$  we calculate the successive terms to 16D

|         |       |       |       |   |
|---------|-------|-------|-------|---|
| +.99505 | 99842 | 42230 |       |   |
| —       | 5     | 72204 | 35976 | 6 |
| —       |       | 2952  | 57449 | 6 |
| —       |       | 8     | 63097 | 8 |
| —       |       |       | 1439  | 4 |
| —       |       |       |       | 9 |
| .99500  | 24676 | 84265 |       | 7 |

The result correct to 17D is

$$P(2.576) = .99500 \quad 24676 \quad 84264 \quad 98$$

**Calculation for Arbitrary Mean and Variance**

**Example 3.** Find the value to 5D of

$$P\{X \leq .50\} = \frac{1}{2\sqrt{2\pi}} \int_{-\infty}^{.5} e^{-1/2(\frac{t-1}{2})^2} dt$$

using 26.2.8 and Table 26.1.

This represents the probability of the random variable being less than or equal to .5 for a normal distribution with mean  $m=1$  and variance  $\sigma^2=4$ . Using 26.2.8 we have

$$P\{X \leq .5\} = P\left(\frac{.5-1}{2}\right) = P(-.25)$$

Since  $P(-x) = 1 - P(x)$ , we have

$$P(-.25) = 1 - P(.25) = 1 - .59871 = .40129$$

where a two-term Taylor series was used for interpolation. Note that when interpolating for  $P(x)$  for a value of  $x$  midway between the tabulated

values we can write  $x=x_0+.01$  and a two-term Taylor series is  $P(x) = P(x_0) + Z(x_0)10^{-2}$ . Thus one need only multiply  $Z(x_0)$  by  $10^{-2}$  and add the result to  $P(x_0)$ .

**Calculation of  $P(x)$  for  $x$  Approximate**

**Example 4.** Using Table 26.1, find  $P(x)$  for  $x=1.96$ , when there is a possible error in  $x$  of  $\pm 5 \times 10^{-3}$ .

This is an example where the argument is only known approximately. The question arises as to how many decimal places one should retain in  $P(x)$ . If  $\Delta x$  and  $\Delta P(x)$  denote the error in  $x$  and the resulting error in  $P(x)$ , respectively, then

$$\Delta P(x) \approx Z(x)\Delta x$$

Hence  $\Delta P(1.960) = 3 \times 10^{-4}$  which indicates that  $P(1.960)$  need only be calculated to 4D. Therefore  $P(1.960) = .9750$ .

**Inverse Interpolation for  $P(x)$**

**Example 5.** Find the value of  $x$  for which  $P(x) = .97500 \ 00000 \ 00000$  using Table 26.1 and determining as many decimal places as is consistent with the tabulated function.

For inverse interpolation the tabulated function  $P(x)$  may be regarded as having a possible error of  $.5 \times 10^{-15}$ . Hence

$$\Delta x \approx \frac{\Delta P(x)}{Z(x)} = \frac{.5 \times 10^{-15}}{Z(x)}$$

Let  $P(x_0)$  correspond to the closest tabulated value of  $P(x)$ . Then a convenient formula for inverse interpolation is

$$x = x_0 + t + \frac{x_0 t^2}{2} + \frac{2x_0^2 + 1}{6} t^3$$

where

$$t = \frac{P(x) - P(x_0)}{Z(x_0)}$$

If only the first two terms (i.e.,  $x=x_0+t$ ) are used, the error in  $x$  will be bounded by  $\frac{x}{8} \times 10^{-4}$  and the true value will always be greater than the value thus calculated.

With respect to this example,  $\Delta x \approx 10^{-14}$  and thus the interpolated value of  $x$  may be in error by one unit in the fourteenth place. The closest value to  $P(x) = .97500 \ 00000 \ 00000$  is  $P(x_0) = .97500 \ 21048 \ 51780$  with  $x_0=1.96$ . Hence using the preceding inverse interpolation formulas with

$$t = -.00003\ 60167\ 31129$$

and carrying fifteen decimals we have the successive terms

|          |       |       |
|----------|-------|-------|
| +1.96000 | 00000 | 00000 |
| - .00003 | 60167 | 31129 |
| +        | 12    | 71261 |
| -        |       | 68    |
|          |       | 0     |
|          |       |       |
| +1.95996 | 39845 | 40064 |

**Edgeworth Asymptotic Expansion**

**Example 6.** Find the Edgeworth asymptotic expansion 26.2.49 for the c.d.f. of chi-square.

*Method 1.* Expansion for  $\chi^2$

Let

$$Q(\chi^2|\nu) = 1 - F(t)$$

where

$$t = \frac{\chi^2 - \nu}{(2\nu)^{1/2}}$$

Since the values of  $\gamma_1$  and  $\gamma_2$  26.4.33 are

$$\gamma_1 = 2\sqrt{2}/\nu^{1/2}$$

$$\gamma_2 = 12/\nu$$

we obtain, by using the first two bracketed terms of 26.2.49

$$F(t) \sim P(t) - \frac{1}{\nu^{1/2}} \left[ \frac{\sqrt{2}}{3} Z^{(2)}(t) \right] + \frac{1}{\nu} \left[ \frac{1}{2} Z^{(3)}(t) + \frac{1}{9} Z^{(5)}(t) \right]$$

The Edgeworth expansion is an asymptotic expansion in terms of derivatives of the normal distribution function. It is often possible to transform a random variable so that the distribution of the transformed random variable more closely approximates the normal distribution function than does the distribution of the original random variable. Hence for the same number of terms, greater accuracy may be achieved by using the transformed variable in the expansion. Since the distribution of  $\sqrt{2\chi^2}$  is more closely approximated by a normal distribution than  $\chi^2$  itself (as judged by a comparison of the values of  $\gamma_1$  and  $\gamma_2$ ), we would expect that the Edgeworth asymptotic expansion of  $\sqrt{2\chi^2}$  would be superior to that of  $\chi^2$ .

*Method 2.* Expansion for  $\sqrt{2\chi^2}$ . Let

$$Q(\chi^2|\nu) = 1 - F(t) = 1 - F\left(\frac{\sqrt{2\chi^2} - (2\nu - 1)^{1/2}}{\left(1 - \frac{1}{4\nu}\right)^{1/2}}\right)$$

where  $(2\nu - 1)^{1/2}$  and  $1 - \frac{1}{4\nu}$  are the mean and variance to terms of order  $\nu^{-2}$  of  $\sqrt{2\chi^2}$  (see 26.4.34). The values of  $\gamma_1$  and  $\gamma_2$  for  $\sqrt{2\chi^2}$  are

$$\gamma_1 \approx \frac{1}{\sqrt{2\nu}} \left[ 1 + \frac{5}{8\nu} \right] \quad \gamma_2 \approx \frac{3}{4\nu^2}$$

Thus we obtain

$$F(t) \sim P(t) - \frac{1}{\nu^{1/2}} \left[ \frac{\sqrt{2}}{12} \left( 1 + \frac{5}{8\nu} \right) Z^{(2)}(t) \right] + \frac{1}{\nu} \left[ \frac{1}{32\nu} Z^{(3)}(t) + \frac{1}{144} \left( 1 + \frac{5}{8\nu} \right)^2 Z^{(5)}(t) \right]$$

For numerical examples using these expansions see **Example 12.**

**Calculation of  $L(h, k, \rho)$**

**Example 7.** Find  $L(.5, .4, .8)$ . Using 26.3.20

$$\sqrt{h^2 - 2\rho hk + k^2} = \sqrt{.09} = .3$$

$$L(.5, .4, .8) = L(.5, 0, 0) + L(.4, 0, -.6)$$

Reference to **Figure 26.2** yields

$$L(.5, 0, 0) + L(.4, 0, -.6) = .16 + .08 = .24$$

The answer to 3D is  $L(.5, .4, .8) = .250$ .

**Calculation of the Bivariate Normal Probability Function**

**Example 8.** Let  $X$  and  $Y$  follow a bivariate normal distribution with parameters  $m_x = 3$ ,  $m_y = 2$ ,  $\sigma_x = 4$ ,  $\sigma_y = 2$ , and  $\rho = -.125$ . Find the value of  $P_r\{X \geq 2, Y \geq 4\}$  using 26.3.20 and **Figures 26.2, 26.3.**

Since  $P_r\{X \geq h, Y \geq k\} = L\left(\frac{h - m_x}{\sigma_x}, \frac{k - m_y}{\sigma_y}, \rho\right)$  we have  $P\{X \geq 2, Y \geq 4\} = L(-.25, 1, -.125)$ . Using 26.3.20

$$L(-.25, 1, -.125) = L(-.25, 0, .969) + L(1, 0, .125) - \frac{1}{2}$$

**Figure 26.2** only gives values for  $h > 0$ , however, using the relationship 26.3.8 with  $k = 0$ ,  $L(-h, 0, \rho) = \frac{1}{2} - L(h, 0, -\rho)$  and thus  $L(-.25, 0, .969) = \frac{1}{2} - L(.25, 0, -.969)$ . Therefore  $L(-.25, 1, -.125) = -L(.25, 0, -.969) + L(1, 0, .125) = -.01 + .09 = .08$ . The answer to 3D is  $L(-.25, 1, -.125) = .080$ .

Approximating  $Q(F|v_1, v_2)$

**Example 23.** Calculate  $Q(1.714|10, 40)$  using 26.6.15.

The approximation given by 26.6.15 will result in a maximum error of .0005. For this example we have

$$x = \frac{(1.714)^{1/3} \left(1 - \frac{2}{9(40)}\right) - \left(1 - \frac{2}{9(10)}\right)}{\left[\frac{2}{9(10)} + (1.714)^{2/3} \frac{2}{9(40)}\right]^{1/2}} = 1.2222$$

Interpolating in Table 26.1 results in

$$Q(1.714|10, 40) \approx Q(1.2222) = 1 - P(1.2222) = .1108$$

The correct value to 5D is  $Q(1.714|10, 40) = .11108$ .

On the other hand the approximation given by 26.6.14 which is usually less accurate results in

$$x = \frac{\sqrt{[2(40) - 1] \left(\frac{10}{40}\right) (1.714) - \sqrt{2(10) - 1}}}{\sqrt{1 + \frac{10}{40} (1.714)}} = 1.2210$$

and interpolating in Table 26.1 gives

$$Q(1.714|10, 40) \approx Q(1.2210) = 1 - P(1.2210) = .1112$$

Calculation of  $F$  Outside the Range of Table 26.9

**Example 24.** Find the value of  $F$  for which  $Q(F|10, 20) \approx .0001$  using 26.6.16 and 26.5.22.

For this problem we have  $a = \frac{v_2}{2} = 10$ ,  $b = \frac{v_1}{2} = 5$ ,  $p = .0001$ . The value of the normal deviate which cuts off .0001 in the tail of the distribution is

$y = 3.7190$  (i.e.,  $Q(3.7190) = .0001$ ). Hence substituting in 26.5.22 gives

$$h = 2 \left[ \frac{1}{19} + \frac{1}{9} \right]^{-1} = 12.2143$$

$$\lambda = \frac{3.7190^2 - 3}{6} = 1.8052$$

$$w = 3.7190 \frac{(12.2143 + 1.8052)^{1/2}}{12.2143}$$

$$- \left( \frac{1}{9} - \frac{1}{19} \right) \left[ 1.8052 + .8333 - \frac{2}{3(12.2143)} \right]$$

$$w = .9889$$

and thus  $F \approx e^{2w} = 7.23$ . The correct answer is  $F = 7.180$ .

Approximating the Non-Central  $F$ -Distribution

**Example 25.** Compute  $P(3.71|3, 10, 4)$  using the approximation 26.6.27 to the non-central  $F$ -distribution.

Using 26.6.27 with  $v_1 = 3$ ,  $v_2 = 10$ ,  $\lambda = 4$ ,  $F' = 3.71$  we have

$$x = \frac{\left[ \left( \frac{3}{3+4} \right) (3.71) \right]^{1/3} \left[ 1 - \frac{2}{9(10)} \right] - \left[ 1 - \frac{2(3+8)}{9(3+4)^2} \right]}{\left[ \frac{2}{9} \frac{3+8}{(3+4)^2} + \frac{2}{9(10)} \left[ \left( \frac{3}{3+4} \right) (3.71) \right]^{2/3} \right]^{1/2}} = .675$$

and interpolating in Table 26.1 gives

$$P(3.71|3, 10, 4) \approx P(.675) = .750$$

The exact answer is  $P(3.71|3, 10, 4) = .745$ .

References

Texts

- [26.1] H. Cramér, *Mathematical methods of statistics* (Princeton Univ. Press, Princeton, N.J., 1951).
- [26.2] A. Erdélyi et al., *Higher transcendental functions*, vols. I, II, III. (McGraw-Hill Book Co., Inc., New York, N.Y., 1955).
- [26.3] W. Feller, *Probability theory and its applications*, 2d ed. (John Wiley & Sons, Inc., New York, N.Y., 1957).
- [26.4] R. A. Fisher, *Contributions to mathematical statistics*, Paper 30 (with E. A. Cornish), Moments and cumulants in the specification of distributions (John Wiley & Sons, Inc., New York, N.Y., 1950).
- [26.5] C. Hastings, Jr., *Approximations for digital computers* (Princeton Univ. Press, Princeton, N.J., 1955).
- [26.6] M. G. Kendall and A. Stuart, *The advanced theory of statistics*, vol. I, Distribution theory (Charles Griffin and Co. Ltd., London, England, 1958).

Tables

General Collections

- [26.7] R. A. Fisher and F. Yates, *Statistical tables for biological, agricultural and medical research* (Oliver and Boyd, London, England, 1949).
- [26.8] J. Arthur Greenwood and H. O. Hartley, *Guide to tables in mathematical statistics* (Princeton Univ. Press, Princeton, N.J., 1962). (Catalogues a large selection of tables used in mathematical statistics).
- [26.9] A. Hald, *Statistical tables and formulas* (John Wiley & Sons, Inc., New York, N.Y., 1952).
- [26.10] D. B. Owen, *Handbook of statistical tables* (Addison-Wesley Publishing Co., Inc., Reading, Mass., 1962).
- [26.11] E. S. Pearson and H. O. Hartley (Editors). *Biometrika tables for statisticians*, vol. I (Cambridge Univ. Press, Cambridge, England, 1954).

- [26.12] K. Pearson (Editor), Tables for statisticians and biometricians, parts I and II (Cambridge Univ. Press, Cambridge, England, 1914, 1931).
- Normal Probability Integral and Derivatives**
- [26.13] J. R. Airey, Table of  $Hh$  functions, British Association for the Advancement of Science, Mathematical Tables I (Cambridge Univ. Press, Cambridge, England, 1931).
- [26.14] Harvard University, Tables of the error function and of its first twenty derivatives (Harvard Univ. Press, Cambridge, Mass., 1952).  $P(x) - \frac{1}{2}$ ,  $Z(x)$ ,  $Z^{(n)}(x)$ ,  $n=1(1)4$  for  $x=0(.004)6.468$ , 6D;  $Z^{(n)}(x)$ ,  $n=5(1)10$  for  $x=0(.004)8.236$ , 6D;  $Z^{(n)}(x)$ ,  $n=11(1)15$  for  $x=0(.002)9.61$ , 7S;  $Z^{(n)}(x)$ ,  $n=16(1)20$  for  $x=0(.002)10.902$ , 7S or 6D.
- [26.15] T. L. Kelley, The Kelley Statistical Tables (Harvard Univ. Press, Cambridge, Mass., 1948).  $x$  for  $P(x)=.5(.0001).9999$  and corresponding values of  $Z(x)$ , 8D.
- [26.16] National Bureau of Standards, A guide to tables of the normal probability integral, Applied Math. Series 21 (U.S. Government Printing Office, Washington, D.C., 1951).
- [26.17] National Bureau of Standards, Tables of normal probability functions, Applied Math. Series 23 (U.S. Government Printing Office, Washington, D.C., 1953).  $Z(x)$  and  $A(x)$  for  $x=0(.0001)1(.001)7.8$ , 15D;  $Z(x)$  and  $2[1-P(x)]$  for  $x=6(.01)10$ , 7S.
- [26.18] W. F. Sheppard, The probability integral, British Association for the Advancement of Science, Mathematical Tables VII (Cambridge Univ. Press, Cambridge, England, 1939).  $A(x)/Z(x)$  for  $x=0(.01)10$ , 12D;  $x=0(.1)10$ , 24D.
- Bivariate Normal Probability Integral**
- [26.19] Bell Aircraft Corporation, Table of circular normal probabilities, Report No. 02-949-106 (1956). Tabulates the integral of the circular normal distribution over an off-set circle having its center a distance  $r$  from the origin with radius  $R$ ;  $R=0(.01)4.59$ ,  $r=0(.01)3$ , 5D.
- [26.20] National Bureau of Standards, Tables of the bivariate normal distribution function and related functions, Applied Math. Series 50 (U.S. Government Printing Office, Washington, D.C., 1959).  $L(h, k, \rho)$  for  $h, k=0(.1)4$ ,  $\rho=0(.05).95(.01)1$ , 6D;  $L(h, k, -\rho)$  for  $h, k=0(.1)A$ ,  $\rho=0(.05).95(.01)1$  where  $A$  is such that  $L < .5 \cdot 10^{-7}$ , 7D;  $V(h, ah)$  for  $h=0(.01)4(.02)4.6(.1)5.6$ ,  $\infty$ , 7D;  $V(ah, h)$  for  $a=.1(.1)1$ ,  $h=0(.01)4(.02)5.6$ ,  $\infty$ , 7D.
- [26.21] C. Nicholson, The probability integral for two variables, Biometrika 33, 59-72 (1943).  $V(h, ah)$  for  $h=.1(.1)3$ ,  $ah=.1(.1)3$ ,  $\infty$ , 6D.
- [26.22] D. B. Owen, Tables for computing bivariate normal probabilities, Ann. Math. Statist. 27, 1075-1090 (1956).  $T(h, a) = \frac{1}{2\pi} \arctan a - V(h, ah)$  for  $a=.25(.25)1$ ,  $h=0(.01)2(.02)3$ ;  $a=0(.01)1$ ,  $\infty$ ,  $h=0(.25)3$ ;  $a=.1, .2(.05).5(.1).8, 1, \infty$ ,  $h=3(.05)3.5(.1)4.7$ , 6D.
- [26.23] D. B. Owen, The bivariate normal probability function, Office of Technical Services, U.S. Department of Commerce (1957).  $T(h, a) = \frac{1}{2\pi} \arctan a - V(h, ah)$  for  $a=0(.025)1, \infty$ ;  $h=0(.01)3.5(.05)4.75$ , 6D.
- [26.24] Tables VIII and IX, Part II of [26.12].  $L(h, k, \rho)$  for  $h, k=0(.1)2.6$ ,  $\rho=-1(.05)1$ , 6D for  $\rho > 0$  and 7D for  $\rho < 0$ .
- Chi-Square, Non-Central Chi-Square, Probability Integral, Incomplete Gamma Function, Poisson Distribution**
- [26.25] G. A. Campbell, Probability curves showing Poisson's exponential summation, Bell System Technical Journal, 95-113 (1923). Tabulates values of  $m = \frac{x^2}{2}$  for which  $Q(x^2|\nu) = .000001$ , 2D; .0001, .01, 3D; .1, .25, .5, .75, .9, 4D; .99, .9999, 3D; .999999, 2D for  $c = \frac{\nu}{2} = 1(1)101$ .
- [26.26] Table IV of [26.7]. Tabulates values of  $x^2$  for  $Q(x^2|\nu) = .001, .01, .02, .05, .1, .2, .3, .5, .7, .8, .9, .95, .98, .99$  and  $\nu=1(1)30, 3D$  or  $3S$ .
- [26.27] E. Fix, Tables of noncentral  $\chi^2$ , Univ. of California Publications in Statistics 1, 15-19 (1949). Tabulates  $\lambda$  for  $P(\chi^2|\nu, \lambda) = .1(.1).9$ ,  $Q(\chi^2|\nu) = .01, .05$ ;  $\nu=1(1)20(2)40(5)60(10)100$ , 3D or 3S.
- [26.28] H. O. Hartley and E. S. Pearson, Tables of the  $\chi^2$  integral and of the cumulative Poisson distribution, Biometrika 37, 313-325 (1950). Also reproduced as Table 7 in [26.11].  $P(\chi^2|\nu)$  for  $\nu=1(1)20(2)70$ ,  $\chi^2=0(.001).01(.01).1(.1)2(.2)10(.5)20(1)40(2)134$ , 5D.
- [26.29] T. Kitagawa, Tables of Poisson distribution (Baifukan, Tokyo, Japan, 1951).  $e^{-m}m^s/s!$  for  $m=.001(.001)1(.01)5$ , 8D;  $m=5(.01)10$ , 7D.
- [26.30] E. C. Molina, Poisson's exponential binomial limit (D. Van Nostrand Co., Inc., New York, N.Y., 1940).  $e^{-m}m^s/s!$  and  $P(\chi^2|\nu) = \sum_{j=c}^{\infty} e^{-m}m^j/j!$  for  $m = \chi^2/2 = 0(.1)16(1)100$ , 6D;  $m=0(.001).01(.01)3$ , 7D.
- [26.31] K. Pearson (Editor), Tables of the incomplete  $\Gamma$ -function, Biometrika Office, University College (Cambridge Univ. Press, Cambridge, England, 1934).  $I(u, p)$  for  $p = -1(.05)0(.1)5(.2)50$ ,  $u=0(.1)I(u, p)=1$  to 7D;  $p = -1(.01) -.75$ ,  $u=0(.1)6$ , 5D;  $\ln[I(u, p)|u^{\nu+1}]$ ,  $p = -1(.05)0(.1)10$ ,  $u=0(.1)1.5$ , 8D;  $[x^{\nu+1} \Gamma(p+1)]^{-1} \gamma(p, x)$ ,  $p = -1(.01) -.9$ ,  $x=0(.01)3$ , 7D.
- [26.32] E. E. Sluckii, Tablitsy dlya vyčisleniya nepolno $\Gamma$ -funktsii i funktsii veroyatnosti  $\chi^2$ . (Izdat. Akad. Nauk SSSR, Moscow-Leningrad, U.S.S.R., 1950).  $\Gamma(\chi^2, \nu) = \left(\frac{1}{2} \chi^2\right)^{-\nu/2} P(\chi^2|\nu)$ ,  $\mathcal{P}(t, \nu) = Q(\chi^2|\nu)$ ,  $\Pi(t, x) = Q(\chi^2|\nu)$  where  $t = (2\chi^2)^{\frac{1}{2}} - (2\nu)^{\frac{1}{2}}$ ,  $x = (\nu/2)^{-\frac{1}{2}}$ .  $\Gamma(\chi^2, \nu)$ ,  $\chi^2=0(.05)2(.1)10$ ,  $\nu=0(.05)2(.1)6$ ;  $Q(\chi^2|\nu)$ ,  $\chi^2=0(.1)3.2$ ,  $\nu=0(.05)2(.1)6$ ;  $\chi^2=3.2(.2)7(.5)10(1)35$ ,  $\nu=0(.1).4(.2)6$ ;  $\mathcal{P}(t, \nu)$ ,  $t = -4(.1)4.8$ ,  $\nu=6(.5)11(1)32$ ;  $\Pi(t, x)$ :  $t = -4.5(.1)4.8$ ,  $x=0(.02).22(.01).25$ , 5D.



**Incomplete Beta Function, Binomial Distribution**

[26.33] Harvard University, Tables of the cumulative binomial probability distribution (Harvard Univ. Press, Cambridge, Mass., 1955).

$$\sum_{s=c}^{\infty} \binom{n}{s} p^s (1-p)^{n-s} \text{ for } p = .01(.01).5, 1/16, 1/12, 1/8, 1/6, 3/16, 5/16, 1/3, 3/8, 5/12, 7/16, n = 1(1)50(2)100(10)200(20)500(50)1000, 5D.$$

[26.34] National Bureau of Standards, Tables of the binomial probability distribution, Applied Math. Series 6 (U.S. Government Printing Office, Washington, D.C., 1950).  $\binom{n}{s} p^s (1-p)^{n-s}$  and

$$\sum_{s=c}^n \binom{n}{s} p^s (1-p)^{n-s} \text{ for } p = .01(.01).5, n = 2(1)49, 7D.$$

[26.35] K. Pearson (Editor), Tables of the incomplete beta function, Biometrika Office, University College (Cambridge Univ. Press, Cambridge, England, 1948).  $I_x(a, b)$  for  $x = .01(.01)1$ ;  $a, b = .5(.5)11(1)50, a \geq b, 7D.$

[26.36] W. H. Robertson, Tables of the binomial distribution function for small values of  $p$ , Office of Technical Services, U.S. Department of Commerce (1960).

$$\sum_{s=0}^c \binom{n}{s} p^s (1-p)^{n-s} \text{ for } p = .001(.001).02, n = 2(1)100(2)200(10)500(20)1000; p = .021(.001).05, n = 2(1)50(2)100(5)200(10)300(20)600(50)1000, 5D.$$

[26.37] H. G. Romig, 50-100 Binomial tables (John Wiley & Sons, Inc., New York, N.Y., 1953).

$$\binom{n}{s} p^s (1-p)^{n-s} \text{ and } \sum_{s=0}^c \binom{n}{s} p^s (1-p)^{n-s} \text{ for } p = .01(.01).5 \text{ and } n = 50(5)100, 6D.$$

[26.38] C. M. Thompson, Tables of percentage points of the incomplete beta function, Biometrika **32**, 151-181 (1941). Also reproduced as Table 16 in [26.11]. Tabulates values of  $x$  for which  $I_x(a, b) = .005, .01, .025, .05, .1, .25, .5$ ;  $2a = 1(1)30, 40, 60, 120, \infty$ ;  $2b = 1(1)10, 12, 15, 20, 24, 30, 40, 60, 120, 5D.$

[26.39] U.S. Ordnance Corps, Tables of the cumulative binomial probabilities, ORDP 20-1, Office of Technical Services, Washington, D.C. (1952).

$$\sum_{s=c}^n \binom{n}{s} p^s (1-p)^{n-s} \text{ for } p = .01(.01).5 \text{ and } n = 1(1)150, 7D.$$

**F (Variance-Ratio) and Non-Central F Distribution**

[26.40] Table V of [26.7]. Tabulates values of  $F$  and  $Z = \frac{1}{2} \ln F$  for  $Q(F|\nu_1, \nu_2) = .2, .1, .05, .01, .001$ ;

$$\nu_1 = 1(1)6, 8, 12, 24, \infty; \nu_2 = 1(1)30, 40, 60, 120, \infty, 2D \text{ for } F, 4D \text{ for } Z.$$

[26.41] E. Lehmer, Inverse tables of probabilities of errors of the second kind, Ann. Math. Statist. **15**, 388-398 (1944).  $\phi = \sqrt{\lambda/(\nu_1 + 1)}$  for  $\nu_1 = 1(1)10, 12, 15, 20, 24, 30, 40, 60, 120, \infty$ ;  $\nu_2 = 2(2)20, 24, 30, 40, 60, 80, 120, 240, \infty$  and  $P(F'|\nu_1, \nu_2, \phi) = .2, .3$  where  $Q(F'|\nu_1, \nu_2) = .01, .05, 3D \text{ or } 3S.$

[26.42] M. Merrington and C. M. Thompson, Tables of percentage points of the inverted beta ( $F$ ) distribution, Biometrika **33**, 73-88 (1943). Tabulates values of  $F$  for which  $Q(F|\nu_1, \nu_2) = .5, .25, .1, .05, .025, .01, .005$ ;  $\nu_1 = 1(1)10, 12, 15, 20, 24, 30, 40, 60, 120, \infty$ ;  $\nu_2 = 1(1)30, 40, 60, 120, \infty.$

[26.43] P. C. Tang, The power function of the analysis of variance tests with tables and illustrations of their use, Statistical Research Memoirs II, 126-149 and tables (1938).  $P(F'|\nu_1, \nu_2, \phi)$  for  $\nu_1 = 1(1)8, \nu_2 = 2(2)6(1)30, 60, \infty$  and  $\phi = \sqrt{\lambda/(\nu_1 + 1)} = 1(.5)3(1)8$  where  $Q(F'|\nu_1, \nu_2) = .01, .05, 3D.$

**Student's t and Non-Central t-Distributions**

[26.44] E. T. Federighi, Extended tables of the percentage points of Student's  $t$ -distribution, J. Amer. Statist. Assoc. **54**, 683-688 (1959.) Values of

$$t \text{ for which } Q(t|\nu) = \frac{1}{2} [1 - A(t|\nu)] = .25 \times 10^{-n}, .1 \times 10^{-n}, n = 0(1)6, .05 \times 10^{-n}, n = 0(1)5, \nu = 1(1)30(5)60(10)100, 200, 500, 1000, 2000, 10000, \infty; 3D.$$

[26.45] Table III of [26.7]. Values of  $t$  for which  $A(t|\nu) = .1(.1).9, .95, .98, .99, .999$  and  $\nu = 1(1)30, 40, 60, 120, \infty; 3D.$

[26.46] N. L. Johnson and B. L. Welch, Applications of the noncentral  $t$ -distribution, Biometrika **31**, 362-389 (1939). Tabulates an auxiliary function which enables calculation of  $\delta$  for given  $t'$  and  $p$ , or  $t'$  for given  $\delta$  and  $p$  where  $P(t'|\nu, \delta) = p = .005, .01, .025, .05, .1(.1).9, .95, .975, .99, .995.$

[26.47] J. Neyman and B. Tokarska, Errors of the second kind in testing Student's hypothesis, J. Amer. Statist. Assoc. **31**, 318-326 (1936). Tabulates  $\delta$  for  $P(t'|\nu, \delta) = .01, .05, .1(.1).9$ ;  $\nu = 1(1)30, \infty$ ;  $Q(t'|\nu) = .01, .05.$

[26.48] Table 9 of [26.11].  $P(t|\nu) = \frac{1}{2} [1 + A(t|\nu)]$  for  $t = 0(.1)4(.2)8$ ;  $\nu = 1(1)20, 5D$ ;  $t = 0(.05)2(.1)4, 5$ ;  $\nu = 20(1)24, 30, 40, 60, 120, \infty, 5D.$

[26.49] G. S. Resnikoff and G. J. Lieberman, Tables of the noncentral  $t$ -distribution (Stanford Univ. Press, Stanford, Calif., 1957).  $\partial P(t'|\nu, \delta)/\partial t'$  and  $P(t'|\nu, \delta)$  for  $\nu = 2(1)24(5)49, \delta = \sqrt{\nu + 1} x_p$  where  $Q(x_p) = p = .25, .15, .1, .065, .04, .025, .01, .004, .0025, .001$  and  $t'/\sqrt{\nu}$  covers the range of values such that throughout most of the table the entries lie between 0 and 1, 4D.

**Random Numbers and Normal Deviates**

[26.50] E. C. Fieller, T. Lewis and E. S. Pearson, Correlated random normal deviates, Tracts for Computers 26 (Cambridge Univ. Press, Cambridge, England, 1955).

[26.51] T. E. Hull and A. R. Dobell, Random number generators, Soc. Ind. App. Math. **4**, 230-254 (1962).

[26.52] M. G. Kendall and B. Babington Smith, Random sampling numbers (Cambridge Univ. Press, Cambridge, England, 1939).

- [26.53] G. Marsaglia, Random variables and computers, Proc. Third Prague Conference in Probability Theory 1962. (Also as Math. Note No. 260, Boeing Scientific Research Laboratories, 1962).
- [26.54] M. E. Muller, An inverse method for the generation of random normal deviates on large scale computers, Math. Tables Aids Comp. **63**. 167-174 (1958).
- [26.55] Rand Corporation, A million random digits with 100,000 normal deviates (The Free Press, Glencoe, Ill. 1955).
- [26.56] H. Wold, Random normal deviates, Tracts for Computers 25 (Cambridge Univ. Press, Cambridge, England, 1948).

# 27. Miscellaneous Functions

IRENE A. STEGUN<sup>1</sup>

## Contents

|   | Page |
|---|------|
| <b>27.1. Debye Functions</b> $\int_0^x \frac{t^n dt}{e^t - 1}$ . . . . .  | 998  |
| $n=1(1)4, x=0(.1)1.4(.2)5(.5)10, 6D$  |      |
| <b>27.2. Planck's Radiation Function</b> $x^{-5}(e^{1/x} - 1)^{-1}$ . . . . .                                   | 999  |
| $x=.05(.005).1(.01).2(.02).4(.05).9(.1)1.5(.5)3.5, 3D$  |      |
| $x_{\max}, f(x_{\max}), 9-10S$  |      |
| <b>27.3. Einstein Functions</b> . . . . .   | 999  |
| $\frac{x^2 e^x}{(e^x - 1)^2}, \frac{x}{e^x - 1}, \ln(1 - e^{-x}), \frac{x}{e^x - 1} - \ln(1 - e^{-x})$          |      |
| $x=0(.05)1.5(.1)3(.2)6, 5D$   |      |
| <b>27.4. Sievert Integral</b> $\int_0^\theta e^{-x \sec \phi} d\phi$ . . . . .                                  | 1000 |
| $x=0(.1)1(.2)3(.5)10, \theta=10^\circ(10^\circ)60^\circ(15^\circ)90^\circ, 6D$                                  |      |
| <b>27.5. <math>f_m(x) = \int_0^\infty t^m e^{-t^2 - \frac{x}{t}} dt</math> and Related Integrals</b> . . . . .  | 1001 |
| $f_m(x), m=1, 2, 3; x=0(.01).05, .1(.1)1, 4D$   |      |
| $f_3(ix), x=0(.2)8(.5)15(1)20, 4-5D$  |      |
| <b>27.6. <math>f(x) = \int_0^\infty \frac{e^{-t^2}}{t+x} dt</math></b> . . . . .                                | 1003 |
| $f(x) + \ln x, x=0(.05)1$   |      |
| $f(x), x=1(.1)3(.5)8, 4D$   |      |
| <b>27.7. Dilogarithm (Spence's Integral) <math>f(x) = -\int_1^x \frac{\ln t}{t-1} dt</math></b> . . . . .       | 1004 |
| $x=0(.01).5, 9D$  |      |
| <b>27.8. Clausen's Integral and Related Summations</b> . . . . .  | 1005 |
| $f(\theta) = -\int_0^\theta \ln\left(2 \sin \frac{t}{2}\right) dt = \sum_{n=1}^\infty \frac{\sin n\theta}{n^2}$ |      |
| $f(\theta) + \theta \ln \theta, \theta=0^\circ(1^\circ)15^\circ$  |      |
| $f(\theta), \theta=15^\circ(1^\circ)30^\circ(2^\circ)90^\circ(5^\circ)180^\circ, 6D$                            |      |
| <b>27.9. Vector-Addition Coefficients <math>(j_1 j_2 m_1 m_2   j_1 j_2 j m)</math></b> . . . . .                | 1006 |
| Algebraic Expressions for $j_2=1/2, 1, 3/2, 2$  |      |
| Decimal Values for $j_2=1/2, 1, 3/2, 5D$  |      |

<sup>1</sup> National Bureau of Standards.



# 27. Miscellaneous Functions

## 27.1. Debye Functions

### Series Representations

27.1.1

$$\int_0^x \frac{t^n dt}{e^t - 1} = x^n \left[ \frac{1}{n} - \frac{x}{2(n+1)} + \sum_{k=1}^{\infty} \frac{B_{2k} x^{2k}}{(2k+n)(2k)!} \right]$$

( $|x| < 2\pi, n \geq 1$ )

(For Bernoulli numbers  $B_{2k}$ , see chapter 23.)

27.1.2

$$\int_x^{\infty} \frac{t^n dt}{e^t - 1} = \sum_{k=1}^{\infty} e^{-kx} \left[ \frac{x^n}{k} + \frac{nx^{n-1}}{k^2} + \frac{(n)(n-1)x^{n-2}}{k^3} + \dots + \frac{n!}{k^{n+1}} \right] (x > 0, n \geq 1)$$

### Relation to Riemann Zeta Function (see chapter 23)

27.1.3  $\int_0^{\infty} \frac{t^n dt}{e^t - 1} = n! \zeta(n+1).$

[27.1] J. A. Beattie, Six-place tables of the Debye energy and specific heat functions, *J. Math. Phys.* **6**, 1-32 (1926).

$$\frac{3}{x^3} \int_0^x \frac{y^3 dy}{e^y - 1}, \frac{12}{x^5} \left[ \int_0^x \frac{y^5 dy}{e^y - 1} - \frac{3x}{e^x - 1} \right], x = 0(.01)24, \quad 6S.$$

[27.2] E. Grüneisen, Die Abhängigkeit des elektrischen Widerstandes reiner Metalle von der Temperatur, *Ann. Physik.* (5) **16**, 530-540 (1933).

$$\frac{20}{x^4} \int_0^x \frac{t^4 dt}{e^t - 1} - \frac{4x}{e^x - 1},$$

$x = 0(.1)13(.2)18(1)20(2)52(4)80, \quad 4S.$

Table 27.1

Debye Functions

| $x$  | $\frac{1}{x} \int_0^x \frac{t dt}{e^t - 1}$ | $\frac{2}{x^2} \int_0^x \frac{t^2 dt}{e^t - 1}$ | $\frac{3}{x^3} \int_0^x \frac{t^3 dt}{e^t - 1}$ | $\frac{4}{x^4} \int_0^x \frac{t^4 dt}{e^t - 1}$ |
|------|---|---|---|---|
| 0.0  | 1.000000                                    | 1.000000  | 1.000000  | 1.000000  |
| 0.1  | 0.975278                                    | 0.967083  | 0.963000  | 0.960555  |
| 0.2  | 0.951111                                    | 0.934999  | 0.926999  | 0.922221  |
| 0.3  | 0.927498                                    | 0.903746  | 0.891995  | 0.884994  |
| 0.4  | 0.904437                                    | 0.873322  | 0.857985  | 0.848871  |
| 0.5  | 0.881927                                    | 0.843721  | 0.824963  | 0.813846  |
| 0.6  | 0.859964                                    | 0.814940  | 0.792924  | 0.779911  |
| 0.7  | 0.838545                                    | 0.786973  | 0.761859  | 0.747057  |
| 0.8  | 0.817665                                    | 0.759813  | 0.731759  | 0.715275  |
| 0.9  | 0.797320                                    | 0.733451  | 0.702615  | 0.684551  |
| 1.0  | 0.777505                                    | 0.707878  | 0.674416  | 0.654874  |
| 1.1  | 0.758213                                    | 0.683086  | 0.647148  | 0.626228  |
| 1.2  | 0.739438                                    | 0.659064  | 0.620798  | 0.598598  |
| 1.3  | 0.721173                                    | 0.635800  | 0.595351  | 0.571967  |
| 1.4  | 0.703412                                    | 0.613281  | 0.570793  | 0.546317  |
| 1.6  | 0.669366                                    | 0.570431  | 0.524275  | 0.497882  |
| 1.8  | 0.637235                                    | 0.530404  | 0.481103  | 0.453131  |
| 2.0  | 0.606947                                    | 0.493083  | 0.441129  | 0.411893  |
| 2.2  | 0.578427                                    | 0.458343  | 0.404194  | 0.373984  |
| 2.4  | 0.551596                                    | 0.426057  | 0.370137  | 0.339218  |
| 2.6  | 0.526375                                    | 0.396095  | 0.338793  | 0.307405  |
| 2.8  | 0.502682                                    | 0.368324  | 0.309995  | 0.278355  |
| 3.0  | 0.480435                                    | 0.342614  | 0.283580  | 0.251879  |
| 3.2  | 0.459555                                    | 0.318834  | 0.259385  | 0.227792  |
| 3.4  | 0.439962                                    | 0.296859  | 0.237252  | 0.205915  |
| 3.6  | 0.421580                                    | 0.276565  | 0.217030  | 0.186075  |
| 3.8  | 0.404332                                    | 0.257835  | 0.198571  | 0.168107  |
| 4.0  | 0.388148                                    | 0.240554  | 0.181737  | 0.151855  |
| 4.2  | 0.372958                                    | 0.224615  | 0.166396  | 0.137169  |
| 4.4  | 0.358696                                    | 0.209916  | 0.152424  | 0.123913  |
| 4.6  | 0.345301                                    | 0.196361  | 0.139704  | 0.111957  |
| 4.8  | 0.332713                                    | 0.183860  | 0.128129  | 0.101180  |
| 5.0  | 0.320876                                    | 0.172329  | 0.117597  | 0.091471  |
| 5.5  | 0.294240                                    | 0.147243  | 0.095241  | 0.071228  |
| 6.0  | 0.271260                                    | 0.126669  | 0.077581  | 0.055677  |
| 6.5  | 0.251331                                    | 0.109727  | 0.063604  | 0.043730  |
| 7.0  | 0.233948                                    | 0.095707  | 0.052506  | 0.034541  |
| 7.5  | 0.218698                                    | 0.084039  | 0.043655  | 0.027453  |
| 8.0  | 0.205239                                    | 0.074269  | 0.036560  | 0.021968  |
| 8.5  | 0.193294                                    | 0.066036  | 0.030840  | 0.017702  |
| 9.0  | 0.182633                                    | 0.059053  | 0.026200  | 0.014368  |
| 9.5  | 0.173068                                    | 0.053092  | 0.022411  | 0.011747  |
| 10.0 | 0.164443                                    | 0.047971  | 0.019296  | 0.009674  |

$$\left[ \begin{matrix} (-4)5 \\ 5 \end{matrix} \right]$$

$$\left[ \begin{matrix} (-4)6 \\ 5 \end{matrix} \right]$$

$$\left[ \begin{matrix} (-4)6 \\ 5 \end{matrix} \right]$$

$$\left[ \begin{matrix} (-4)6 \\ 5 \end{matrix} \right]$$

Planck's Radiation Function

Table 27.2

$$f(x) = x^{-5}(e^{1/x} - 1)^{-1}$$

| $x$   | $f(x)$ | $x$  | $f(x)$ | $x$  | $f(x)$ | $x$  | $f(x)$ | $x$ | $f(x)$ |
|-------|--------|------|--------|------|--------|------|--------|-----|--------|
| 0.050 | 0.007  | 0.10 | 4.540  | 0.20 | 21.199 | 0.40 | 8.733  | 0.9 | 0.831  |
| 0.055 | 0.025  | 0.11 | 6.998  | 0.22 | 20.819 | 0.45 | 6.586  | 1.0 | 0.582  |
| 0.060 | 0.074  | 0.12 | 9.662  | 0.24 | 19.777 | 0.50 | 5.009  | 1.1 | 0.419  |
| 0.065 | 0.179  | 0.13 | 12.296 | 0.26 | 18.372 | 0.55 | 3.850  | 1.2 | 0.309  |
| 0.070 | 0.372  | 0.14 | 14.710 | 0.28 | 16.809 | 0.60 | 2.995  | 1.3 | 0.233  |
| 0.075 | 0.682  | 0.15 | 16.780 | 0.30 | 15.224 | 0.65 | 2.356  | 1.4 | 0.178  |
| 0.080 | 1.137  | 0.16 | 18.446 | 0.32 | 13.696 | 0.70 | 1.875  | 1.5 | 0.139  |
| 0.085 | 1.752  | 0.17 | 19.692 | 0.34 | 12.270 | 0.75 | 1.508  | 2.0 | 0.048  |
| 0.090 | 2.531  | 0.18 | 20.539 | 0.36 | 10.965 | 0.80 | 1.225  | 2.5 | 0.021  |
| 0.095 | 3.466  | 0.19 | 21.025 | 0.38 | 9.787  | 0.85 | 1.005  | 3.0 | 0.010  |
| 0.100 | 4.540  | 0.20 | 21.199 | 0.40 | 8.733  | 0.90 | 0.831  | 3.5 | 0.006  |

$$x_{\max} = \frac{\binom{-2}{4}}{4} \quad f(x_{\max}) = \frac{\binom{-2}{5}}{5} \quad \frac{\binom{-2}{8}}{5} \quad \frac{\binom{-2}{7}}{5} \quad \frac{\binom{-2}{1}}{4}$$

[27.3] Miscellaneous Physical Tables, Planck's radiation functions and electronic functions, MT 17 (U.S. Government Printing Office, Washington, D.C., 1941).

$$R_\lambda = c_1 \lambda^{-5} (e^{c_2/\lambda T} - 1)^{-1}, \quad R_{0-\lambda} = \int_0^\lambda R_\lambda d\lambda,$$

$$N_\lambda = 2\pi c \lambda^{-4} (e^{c_2/\lambda T} - 1)^{-1}, \quad N_{0-\lambda} = \int_0^\lambda N_\lambda d\lambda$$

Table I:  $\frac{R_\lambda}{R_{\lambda \max}}, \frac{R_{0-\lambda}}{R_{0-\infty}}, \frac{N_\lambda}{N_{\lambda \max}}, \frac{N_{0-\lambda}}{N_{0-\infty}}$  for  $\lambda T = [.05(.001).1(.005).4(.01).6(.02)1(.05)2] \text{ cm K}^\circ$ .

Table II:  $R_\lambda, R_{0-\lambda}, N_\lambda, N_{0-\lambda}$  ( $T = 1000^\circ \text{ K}$ ) for  $\lambda = [.5(.01)1(.05)4(.1)6(.2)10(.5)20] \text{ microns}$ .

Table III:  $N_\lambda$  for  $\lambda = [.25(.05)1.6(.2)3(1)10] \text{ microns}$ ,  $T = [1000^\circ(500^\circ)3500^\circ \text{ K and } 6000^\circ \text{ K}]$ .

Einstein Functions

Table 27.3

| $x$  | $\frac{x^2 e^x}{(e^x - 1)^2}$ | $\frac{x}{e^x - 1}$ | $\ln(1 - e^{-x})$ | $\frac{x}{e^x - 1} - \ln(1 - e^{-x})$ |
|------|-------------------------------|---------------------|-------------------|---------------------------------------|
| 0.00 | 1.00000                       | 1.00000             | $-\infty$         | $\infty$                              |
| 0.05 | 0.99979                       | 0.97521             | -3.02063          | 3.99584                               |
| 0.10 | 0.99917                       | 0.95083             | -2.35217          | 3.30300                               |
| 0.15 | 0.99813                       | 0.92687             | -1.97118          | 2.89806                               |
| 0.20 | 0.99667                       | 0.90333             | -1.70777          | 2.61110                               |
| 0.25 | 0.99481                       | 0.88020             | -1.50869          | 2.38888                               |
| 0.30 | 0.99253                       | 0.85749             | -1.35023          | 2.20771                               |
| 0.35 | 0.98985                       | 0.83519             | -1.21972          | 2.05491                               |
| 0.40 | 0.98677                       | 0.81330             | -1.10963          | 1.92293                               |
| 0.45 | 0.98329                       | 0.79182             | -1.01508          | 1.80690                               |
| 0.50 | 0.97942                       | 0.77075             | -0.93275          | 1.70350                               |
| 0.55 | 0.97517                       | 0.75008             | -0.86026          | 1.61035                               |
| 0.60 | 0.97053                       | 0.72982             | -0.79587          | 1.52569                               |
| 0.65 | 0.96552                       | 0.70996             | -0.73824          | 1.44820                               |
| 0.70 | 0.96015                       | 0.69050             | -0.68634          | 1.37684                               |
| 0.75 | 0.95441                       | 0.67144             | -0.63935          | 1.31079                               |
| 0.80 | 0.94833                       | 0.65277             | -0.59662          | 1.24939                               |
| 0.85 | 0.94191                       | 0.63450             | -0.55759          | 1.19209                               |
| 0.90 | 0.93515                       | 0.61661             | -0.52184          | 1.13844                               |
| 0.95 | 0.92807                       | 0.59910             | -0.48897          | 1.08809                               |
| 1.00 | 0.92067                       | 0.58198             | -0.45868          | 1.04065                               |
| 1.05 | 0.91298                       | 0.56523             | -0.43069          | 0.99592                               |
| 1.10 | 0.90499                       | 0.54886             | -0.40477          | 0.95363                               |
| 1.15 | 0.89671                       | 0.53285             | -0.38073          | 0.91358                               |
| 1.20 | 0.88817                       | 0.51722             | -0.35838          | 0.87560                               |
| 1.25 | 0.87937                       | 0.50194             | -0.33758          | 0.83952                               |
| 1.30 | 0.87031                       | 0.48702             | -0.31818          | 0.80520                               |
| 1.35 | 0.86102                       | 0.47245             | -0.30008          | 0.77253                               |
| 1.40 | 0.85151                       | 0.45824             | -0.28315          | 0.74139                               |
| 1.45 | 0.84178                       | 0.44436             | -0.26732          | 0.71168                               |
| 1.50 | 0.83185                       | 0.43083             | -0.25248          | 0.68331                               |

$$\frac{\binom{-5}{3}}{3} \quad \frac{\binom{-5}{5}}{3}$$

Table 27.3

Einstein Functions

| $x$ | $\frac{x^2 e^x}{(e^x - 1)^2}$ | $\frac{x}{e^x - 1}$ | $\ln(1 - e^{-x})$ | $\frac{x}{e^x - 1} - \ln(1 - e^{-x})$ |
|-----|-------------------------------|---------------------|-------------------|---------------------------------------|
| 1.6 | 0.81143                       | 0.40475             | -0.22552          | 0.63027                               |
| 1.7 | 0.79035                       | 0.37998             | -0.20173          | 0.58171                               |
| 1.8 | 0.76869                       | 0.35646             | -0.18068          | 0.53714                               |
| 1.9 | 0.74657                       | 0.33416             | -0.16201          | 0.49617                               |
| 2.0 | 0.72406                       | 0.31304             | -0.14541          | 0.45845                               |
| 2.1 | 0.70127                       | 0.29304             | -0.13063          | 0.42367                               |
| 2.2 | 0.67827                       | 0.27414             | -0.11744          | 0.39158                               |
| 2.3 | 0.65515                       | 0.25629             | -0.10565          | 0.36194                               |
| 2.4 | 0.63200                       | 0.23945             | -0.09510          | 0.33455                               |
| 2.5 | 0.60889                       | 0.22356             | -0.08565          | 0.30921                               |
| 2.6 | 0.58589                       | 0.20861             | -0.07718          | 0.28578                               |
| 2.7 | 0.56307                       | 0.19453             | -0.06957          | 0.26410                               |
| 2.8 | 0.54049                       | 0.18129             | -0.06274          | 0.24403                               |
| 2.9 | 0.51820                       | 0.16886             | -0.05659          | 0.22545                               |
| 3.0 | 0.49627                       | 0.15719             | -0.05107          | 0.20826                               |
| 3.2 | 0.45363                       | 0.13598             | -0.04162          | 0.17760                               |
| 3.4 | 0.41289                       | 0.11739             | -0.03394          | 0.15133                               |
| 3.6 | 0.37429                       | 0.10113             | -0.02770          | 0.12883                               |
| 3.8 | 0.33799                       | 0.08695             | -0.02262          | 0.10958                               |
| 4.0 | 0.30409                       | 0.07463             | -0.01849          | 0.09311                               |
| 4.2 | 0.27264                       | 0.06394             | -0.01511          | 0.07905                               |
| 4.4 | 0.24363                       | 0.05469             | -0.01235          | 0.06705                               |
| 4.6 | 0.21704                       | 0.04671             | -0.01010          | 0.05681                               |
| 4.8 | 0.19277                       | 0.03983             | -0.00826          | 0.04809                               |
| 5.0 | 0.17074                       | 0.03392             | -0.00676          | 0.04068                               |
| 5.2 | 0.15083                       | 0.02885             | -0.00553          | 0.03438                               |
| 5.4 | 0.13290                       | 0.02450             | -0.00453          | 0.02903                               |
| 5.6 | 0.11683                       | 0.02078             | -0.00370          | 0.02449                               |
| 5.8 | 0.10247                       | 0.01761             | -0.00303          | 0.02065                               |
| 6.0 | 0.08968                       | 0.01491             | -0.00248          | 0.01739                               |

$\left[ \begin{smallmatrix} (-4)3 \\ 4 \end{smallmatrix} \right] \quad \left[ \begin{smallmatrix} (-4)3 \\ 4 \end{smallmatrix} \right] \quad \left[ \begin{smallmatrix} (-4)4 \\ 4 \end{smallmatrix} \right] \quad \left[ \begin{smallmatrix} (-4)6 \\ 4 \end{smallmatrix} \right]$

[27.4] H. L. Johnston, L. Savedoff and J. Belzer, Contributions to the thermodynamic functions by a Planck-Einstein oscillator in one degree of freedom, NAVEXOS p. 646, Office of Naval Research, Department of the Navy, Washington, D.C. (1949). Values of  $x^2 e^x / (e^x - 1)^2$ ,  $x / (e^x - 1)^{-1}$ ,  $-\ln(1 - e^{-x})$  and  $x / (e^x - 1)^{-1} - \ln(1 - e^{-x})$  for  $x = 0(.001)3(.01)14.99$ , 5D with first differences.

27.4. Sievert Integral

$$\int_0^\theta e^{-x \sec \phi} d\phi$$

Relation to the Error Function

27.4.1

$$\int_0^\theta e^{-x \sec \phi} d\phi \sim \sqrt{\frac{\pi}{2x}} e^{-x} \operatorname{erf}\left(\sqrt{\frac{x}{2}} \theta\right) \quad (x \rightarrow \infty)$$

(For erf, see chapter 7.)

Representation in Terms of Exponential Integrals

27.4.2

$$\int_0^\theta e^{-x \sec \phi} d\phi = \int_0^{\frac{\pi}{2}} e^{-x \sec \phi} d\phi - \sum_{k=0}^\infty \alpha_k (\cos \theta)^{2k+1} E_{2k+2}\left(\frac{x}{\cos \theta}\right) \quad \left(x \geq 0, 0 < \theta < \frac{\pi}{2}\right)$$

$$\alpha_0 = 1, \alpha_k = \frac{1 \cdot 3 \cdot 5 \dots (2k-1)}{2 \cdot 4 \cdot 6 \dots (2k)}$$

(For  $E_{2k+2}(x)$ , see chapter 5.)

Relation to the Integral of the Bessel Function  $K_0(x)$

27.4.3

$$\int_0^{\frac{\pi}{2}} e^{-x \sec \phi} d\phi = \operatorname{Ki}_1(x) = \int_x^\infty K_0(t) dt \text{ where}$$

$$x^{\frac{1}{2}} e^x \operatorname{Ki}_1(x) \sim \left(\frac{1}{2}\pi\right)^{\frac{1}{2}} \left\{ 1 - \frac{5}{8x} + \frac{129}{128x^2} - \frac{2655}{1024x^3} + \frac{301035}{32768x^4} - \dots \right\}$$

(For  $\operatorname{Ki}_1(x)$ , see chapter 11.)

[27.5] National Bureau of Standards, Table of the Sievert integral, Applied Math. Series— (U.S. Government Printing Office, Washington, D.C. In press).

[27.6] R. M. Sievert, Die v-Strahlungsintensität an der Oberfläche und in der nächsten Umgebung von Radiumnadeln, Acta Radiologica II, 239-301 (1930).

$$x=0(.01)2(.02)5(.05)10, \theta=0^\circ(1^\circ)90^\circ, 9D.$$

$$\int_0^\pi e^{-x \sin \phi} d\phi, \phi=30^\circ(1^\circ)90^\circ, A=0(.01).5, 3D.$$

Sievert Integral  $\int_0^\theta e^{-x \sin \phi} d\phi$

Table 27.4

| $x \backslash \theta$ | 10°      | 20°      | 30°      | 40°      | 50°      | 60°      | 75°      | 90°      |
|-----------------------|----------|----------|----------|----------|----------|----------|----------|----------|
| 0.0                   | 0.174533 | 0.349066 | 0.523599 | 0.698132 | 0.872665 | 1.047198 | 1.308997 | 1.570796 |
| 0.1                   | 0.157843 | 0.315187 | 0.471456 | 0.625886 | 0.777323 | 0.923778 | 1.123611 | 1.228632 |
| 0.2                   | 0.142749 | 0.284598 | 0.424515 | 0.561159 | 0.692565 | 0.815477 | 0.968414 | 1.023680 |
| 0.3                   | 0.129099 | 0.256978 | 0.382255 | 0.503165 | 0.617194 | 0.720366 | 0.837712 | 0.868832 |
| 0.4                   | 0.116754 | 0.232040 | 0.344209 | 0.451198 | 0.550154 | 0.636769 | 0.727031 | 0.745203 |
| 0.5                   | 0.105589 | 0.209522 | 0.309957 | 0.404629 | 0.490508 | 0.563236 | 0.632830 | 0.643694 |
| 0.6                   | 0.095492 | 0.189191 | 0.279118 | 0.362893 | 0.437428 | 0.498504 | 0.552287 | 0.558890 |
| 0.7                   | 0.086361 | 0.170833 | 0.251353 | 0.325486 | 0.390178 | 0.441478 | 0.483134 | 0.487198 |
| 0.8                   | 0.078103 | 0.154256 | 0.226354 | 0.291957 | 0.348109 | 0.391204 | 0.423535 | 0.426062 |
| 0.9                   | 0.070634 | 0.139289 | 0.203845 | 0.261901 | 0.310642 | 0.346851 | 0.371996 | 0.373579 |
| 1.0                   | 0.063880 | 0.125775 | 0.183579 | 0.234956 | 0.277267 | 0.307694 | 0.327288 | 0.328286 |
| 1.2                   | 0.052247 | 0.102553 | 0.148899 | 0.189138 | 0.221027 | 0.242523 | 0.254485 | 0.254889 |
| 1.4                   | 0.042733 | 0.083620 | 0.120780 | 0.152298 | 0.176336 | 0.191533 | 0.198885 | 0.199051 |
| 1.6                   | 0.034951 | 0.068183 | 0.097979 | 0.122667 | 0.140792 | 0.151541 | 0.156087 | 0.156156 |
| 1.8                   | 0.028587 | 0.055597 | 0.079488 | 0.098829 | 0.112497 | 0.120105 | 0.122932 | 0.122961 |
| 2.0                   | 0.023381 | 0.045335 | 0.064492 | 0.079644 | 0.089954 | 0.095342 | 0.097108 | 0.097121 |
| 2.2                   | 0.019123 | 0.036967 | 0.052329 | 0.064201 | 0.071979 | 0.075797 | 0.076905 | 0.076911 |
| 2.4                   | 0.015641 | 0.030145 | 0.042463 | 0.051766 | 0.057635 | 0.060342 | 0.061040 | 0.061043 |
| 2.6                   | 0.012793 | 0.024582 | 0.034460 | 0.041750 | 0.046179 | 0.048100 | 0.048541 | 0.048542 |
| 2.8                   | 0.010463 | 0.020045 | 0.027968 | 0.033680 | 0.037024 | 0.038387 | 0.038667 | 0.038668 |
| 3.0                   | 0.008558 | 0.016347 | 0.022700 | 0.027177 | 0.029702 | 0.030670 | 0.030848 | 0.030848 |
| 3.5                   | 0.005178 | 0.009817 | 0.013477 | 0.015912 | 0.017164 | 0.017576 | 0.017634 | 0.017634 |
| 4.0                   | 0.003132 | 0.005896 | 0.008005 | 0.009330 | 0.009951 | 0.010128 | 0.010147 | 0.010147 |
| 4.5                   | 0.001895 | 0.003542 | 0.004756 | 0.005478 | 0.005787 | 0.005862 | 0.005869 | 0.005869 |
| 5.0                   | 0.001147 | 0.002127 | 0.002828 | 0.003221 | 0.003374 | 0.003407 | 0.003409 | 0.003409 |
| 5.5                   | 0.000694 | 0.001278 | 0.001682 | 0.001896 | 0.001972 | 0.001986 | 0.001987 | 0.001987 |
| 6.0                   | 0.000420 | 0.000768 | 0.001001 | 0.001117 | 0.001155 | 0.001162 | 0.001162 | 0.001162 |
| 6.5                   | 0.000254 | 0.000461 | 0.000596 | 0.000659 | 0.000678 | 0.000681 | 0.000681 | 0.000681 |
| 7.0                   | 0.000154 | 0.000277 | 0.000355 | 0.000389 | 0.000399 | 0.000400 | 0.000400 | 0.000400 |
| 7.5                   | 0.000093 | 0.000167 | 0.000211 | 0.000230 | 0.000235 | 0.000235 | 0.000235 | 0.000235 |
| 8.0                   | 0.000056 | 0.000100 | 0.000126 | 0.000136 | 0.000139 | 0.000139 | 0.000139 | 0.000139 |
| 8.5                   | 0.000034 | 0.000060 | 0.000075 | 0.000081 | 0.000082 | 0.000082 | 0.000082 | 0.000082 |
| 9.0                   | 0.000021 | 0.000036 | 0.000045 | 0.000048 | 0.000048 | 0.000048 | 0.000048 | 0.000048 |
| 9.5                   | 0.000012 | 0.000022 | 0.000027 | 0.000028 | 0.000028 | 0.000029 | 0.000029 | 0.000029 |
| 10.0                  | 0.000008 | 0.000013 | 0.000016 | 0.000017 | 0.000017 | 0.000017 | 0.000017 | 0.000017 |

$$\left[ \begin{matrix} (-3)2 \\ 6 \end{matrix} \right] \quad \left[ \begin{matrix} (-4)5 \\ 6 \end{matrix} \right] \quad \left[ \begin{matrix} (-4)8 \\ 6 \end{matrix} \right] \quad \left[ \begin{matrix} (-3)1 \\ 7 \end{matrix} \right] \quad \left[ \begin{matrix} (-3)1 \\ 7 \end{matrix} \right] \quad \left[ \begin{matrix} (-3)2 \\ 7 \end{matrix} \right] \quad \left[ \begin{matrix} (-3)4 \\ 7 \end{matrix} \right] \quad \left[ \begin{matrix} (-2)2 \\ 11 \end{matrix} \right]$$

27.5.  $f_m(x) = \int_0^\infty t^m e^{-t^2 - \frac{x}{t}} dt$  and

Related Integrals

$$m=0, 1, 2, \dots$$

Differential Equations

27.5.1  $xf_m''' - (m-1)f_m'' + 2f_m = 0$

27.5.2  $f_m' = -f_{m-1} \quad (m=1, 2, \dots)$

Recurrence Relation

27.5.3  $2f_m = (m-1)f_{m-2} + xf_{m-3} \quad (m \geq 3)$

Power Series Representations

27.5.4  $2f_1(x) = \sum_{k=0}^\infty (a_k \ln x + b_k) x^k$

$$a_k = \frac{-2a_{k-2}}{k(k-1)(k-2)} \quad b_k = \frac{-2b_{k-2} - (3k^2 - 6k + 2)a_k}{k(k-1)(k-2)}$$

$$a_0 = a_1 = 0$$

$$a_2 = -b_0$$

$$b_0 = 1$$

$$b_1 = -\sqrt{\pi} \quad b_2 = \frac{3}{2}(1-\gamma)$$

(For  $\gamma$ , see chapter 6.)

27.5.5

$$2f_1(x) = 1 - \sqrt{\pi}x + .6342x^2 + .5908x^3 - .1431x^4 - .01968x^5 + .00324x^6 + .000188x^7 \dots - x^2 \ln x(1 - .08333x^2 + .001389x^4 - .0000083x^6 + \dots)$$

27.5.6

$$2f_2(x) = \frac{\sqrt{\pi}}{2} - x + \frac{\sqrt{\pi}}{2}x^2 - .3225x^3 - .1477x^4 + .03195x^5 + .00328x^6 - .000491x^7 - .0000235x^8 \dots + x^3 \ln x(\frac{1}{3} - .01667x^2 + .000198x^4 - \dots)$$

27.5.7

$$2f_3(x) = 1 - \frac{\sqrt{\pi}}{2}x + \frac{x^2}{2} - .2954x^3 + .1014x^4 + .02954x^5 - .00578x^6 - .00047x^7 + .000064x^8 \dots - x^4 \ln x(.0833 - .00278x^2 + .000025x^4 - \dots)$$

Asymptotic Representation

27.5.8

$$f_m(x) \sim \sqrt{\frac{\pi}{3}} 3^{-\frac{m}{2}} v^{\frac{m}{2}} e^{-v} \left( a_0 + \frac{a_1}{v} + \frac{a_2}{v^2} + \dots + \frac{a_k}{v^k} + \dots \right) \quad (x \rightarrow \infty)$$

$$v = 3 \left( \frac{x}{2} \right)^{2/3}$$

$$a_0 = 1, a_1 = \frac{1}{12} (3m^2 + 3m - 1)$$

$$12(k+2)a_{k+2} = -(12k^2 + 36k - 3m^2 - 3m + 25)a_{k+1} + \frac{1}{2}(m-2k)(2k+3-m)(2k+3+2m)a_k \quad (k=0, 1, 2 \dots)$$

27.5.9  $g_1(x) + ig_2(x) = \int_0^\infty t^3 e^{-t^2 + it \frac{x}{i}} dt$

27.5.10

$$g_1(x) = \mathcal{H}f_3(ix) \quad g_2(x) = -\mathcal{S}f_3(ix)$$

Asymptotic Representation

27.5.11

$$g_1(x) = \left( \frac{\pi}{3} \right)^{1/2} \frac{x}{2} \exp \left[ -\frac{3}{2} \left( \frac{x}{2} \right)^{2/3} \right] (A \sin \theta + B \cos \theta)$$

27.5.12

$$g_2(x) = -\left( \frac{\pi}{3} \right)^{1/2} \frac{x}{2} \exp \left[ -\frac{3}{2} \left( \frac{x}{2} \right)^{2/3} \right] (A \cos \theta - B \sin \theta)$$

$$\theta = \frac{3}{2} \sqrt{3} \left( \frac{x}{2} \right)^{2/3}$$

$$A \sim a_0 - a_3 \left( \frac{2}{x} \right)^2 + \frac{1}{2} \left[ a_1 \left( \frac{2}{x} \right)^{2/3} - a_2 \left( \frac{2}{x} \right)^{4/3} - a_4 \left( \frac{2}{x} \right)^{8/3} + a_5 \left( \frac{2}{x} \right)^{10/3} - \dots \right] \quad (x \rightarrow \infty)$$

$$B \sim \frac{\sqrt{3}}{2} \left[ a_1 \left( \frac{2}{x} \right)^{2/3} + a_2 \left( \frac{2}{x} \right)^{4/3} - a_4 \left( \frac{2}{x} \right)^{8/3} - a_5 \left( \frac{2}{x} \right)^{10/3} + \dots \right] \quad (x \rightarrow \infty)$$

$$a_0 = 1 \quad a_1 = .972222 \quad a_2 = .148534$$

$$a_3 = -.017879 \quad a_4 = .004594 \quad a_5 = -.000762$$

[27.7] M. Abramowitz, Evaluation of the integral  $\int_0^\infty e^{-u^2 - x/u} du$ , J. Math. Phys. 32, 188-192 (1953).

[27.8] H. Faxén, Expansion in series of the integral  $\int_v^\infty \exp[-x(t \pm t^{-n})] t^2 dt$ , Ark. Mat., Astr., Fys. 15, 13, 1-57 (1921).

[27.9] J. E. Kilpatrick and M. F. Kilpatrick, Discrete energy levels associated with the Lennard-Jones potential, J. Chem. Phys. 19, 7, 930-933 (1951).

[27.10] U. E. Kruse and N. F. Ramsey, The integral  $\int_0^\infty y^3 \exp(-y^2 + i \frac{x}{y}) dy$ , J. Math. Phys. 30, 40 (1951).

[27.11] O. Laporte, Absorption coefficients for thermal neutrons, Phys. Rev. 52, 72-74 (1937).

[27.12] H. C. Torrey, Notes on intensities of radio frequency spectra, Phys. Rev. 59, 293 (1941).

[27.13] C. T. Zahn, Absorption coefficients for thermal neutrons, Phys. Rev. 52, 67-71 (1937).

$$\int_0^\infty y^n e^{-y-x/\sqrt{y}} dy \text{ for } n=0, \frac{1}{2}, 1; x=0(.01).1(.1)1.$$



$$f_m(x) = \int_0^\infty t^m e^{-t^2 - \frac{x}{t}} dt$$

Table 27.5

| $x$  | $f_1(x)$ | $f_2(x)$ | $f_3(x)$ | $x$ | $f_1(x)$ | $f_2(x)$ | $f_3(x)$ | $x$ | $f_1(x)$ | $f_2(x)$ | $f_3(x)$ |
|------|----------|----------|----------|-----|----------|----------|----------|-----|----------|----------|----------|
| 0.00 | 0.5000   | 0.4431   | 0.5000   | 0.1 | 0.4263   | 0.3970   | 0.4580   | 0.6 | 0.2255   | 0.2415   | 0.3025   |
| 0.01 | 0.4914   | 0.4382   | 0.4956   | 0.2 | 0.3697   | 0.3573   | 0.4204   | 0.7 | 0.2015   | 0.2202   | 0.2793   |
| 0.02 | 0.4832   | 0.4333   | 0.4912   | 0.3 | 0.3238   | 0.3227   | 0.3864   | 0.8 | 0.1807   | 0.2011   | 0.2584   |
| 0.03 | 0.4753   | 0.4285   | 0.4869   | 0.4 | 0.2855   | 0.2923   | 0.3557   | 0.9 | 0.1626   | 0.1839   | 0.2392   |
| 0.04 | 0.4676   | 0.4238   | 0.4826   | 0.5 | 0.2531   | 0.2654   | 0.3278   | 1.0 | 0.1466   | 0.1685   | 0.2215   |
| 0.05 | 0.4602   | 0.4191   | 0.4784   |     |          |          |          |     |          |          |          |

$$\left[ \begin{matrix} (-5)5 \\ 2 \end{matrix} \right] \left[ \begin{matrix} (-5)5 \\ 2 \end{matrix} \right] \left[ \begin{matrix} (-5)5 \\ 2 \end{matrix} \right] \quad \left[ \begin{matrix} (-3)1 \\ 4 \end{matrix} \right] \left[ \begin{matrix} (-4)7 \\ 3 \end{matrix} \right] \left[ \begin{matrix} (-4)5 \\ 3 \end{matrix} \right] \quad \left[ \begin{matrix} (-4)6 \\ 3 \end{matrix} \right] \left[ \begin{matrix} (-4)4 \\ 3 \end{matrix} \right] \left[ \begin{matrix} (-4)4 \\ 3 \end{matrix} \right]$$

| $x$ | $\Re f_3(ix)$ | $-\Im f_3(ix)$ | $x$ | $\Re f_3(ix)$ | $-\Im f_3(ix)$ | $x$  | $\Re f_3(ix)$ | $-\Im f_3(ix)$ |
|-----|---------------|----------------|-----|---------------|----------------|------|---------------|----------------|
| 0.0 | 0.50000       | 0.00000        | 4.0 | -0.2626       | 0.0430         | 8.0  | 0.06078       | -0.09808       |
| 0.2 | 0.49019       | 0.08754        | 4.2 | -0.2552       | +0.0094        | 8.5  | 0.07562       | -0.07131       |
| 0.4 | 0.46229       | 0.16933        | 4.4 | -0.2441       | -0.0214        | 9.0  | 0.08221       | -0.04496       |
| 0.6 | 0.41950       | 0.24139        | 4.6 | -0.2299       | -0.0490        | 9.5  | 0.08191       | -0.02082       |
| 0.8 | 0.36543       | 0.30136        | 4.8 | -0.2132       | -0.0734        | 10.0 | 0.07626       | -0.00010       |
| 1.0 | 0.30366       | 0.34805        | 5.0 | -0.1945       | -0.0944        | 10.5 | 0.06684       | +0.01654       |
| 1.2 | 0.23746       | 0.38122        | 5.2 | -0.1745       | -0.1120        | 11.0 | 0.05507       | 0.02889        |
| 1.4 | 0.16972       | 0.40127        | 5.4 | -0.1536       | -0.1263        | 11.5 | 0.04224       | 0.03707        |
| 1.6 | 0.10288       | 0.40910        | 5.6 | -0.1322       | -0.1374        | 12.0 | 0.02937       | 0.04146        |
| 1.8 | +0.03892      | 0.40592        | 5.8 | -0.1108       | -0.1455        | 12.5 | 0.01727       | 0.04259        |
| 2.0 | -0.02062      | 0.39314        | 6.0 | -0.0896       | -0.1507        | 13.0 | +0.00650      | 0.04109        |
| 2.2 | -0.0746       | 0.3722         | 6.2 | -0.0691       | -0.1533        | 13.5 | -0.00259      | 0.03758        |
| 2.4 | -0.1221       | 0.3448         | 6.4 | -0.0493       | -0.1535        | 14.0 | -0.00982      | 0.03268        |
| 2.6 | -0.1629       | 0.3122         | 6.6 | -0.0307       | -0.1515        | 14.5 | -0.01517      | 0.02696        |
| 2.8 | -0.1966       | 0.2759         | 6.8 | -0.0132       | -0.1476        | 15.0 | -0.01872      | 0.02089        |
| 3.0 | -0.2233       | 0.2371         | 7.0 | +0.00286      | -0.14211       | 16.0 | -0.02118      | +0.00921       |
| 3.2 | -0.2432       | 0.1971         | 7.2 | 0.01749       | -0.13518       | 17.0 | -0.01906      | -0.00022       |
| 3.4 | -0.2565       | 0.1569         | 7.4 | 0.03061       | -0.12709       | 18.0 | -0.01435      | -0.00650       |
| 3.6 | -0.2639       | 0.1173         | 7.6 | 0.04220       | -0.11805       | 19.0 | -0.00879      | -0.00965       |
| 3.8 | -0.2657       | 0.0792         | 7.8 | 0.05224       | -0.10830       | 20.0 | -0.00360      | -0.01021       |

$$\left[ \begin{matrix} (-3)2 \\ 6 \end{matrix} \right] \left[ \begin{matrix} (-3)2 \\ 5 \end{matrix} \right] \quad \left[ \begin{matrix} (-4)5 \\ 3 \end{matrix} \right] \left[ \begin{matrix} (-4)4 \\ 4 \end{matrix} \right] \quad \left[ \begin{matrix} (-3)1 \\ 5 \end{matrix} \right] \left[ \begin{matrix} (-4)7 \\ 5 \end{matrix} \right]$$

Compiled from U. E. Kruse and N. F. Ramsey, The integral  $\int_0^\infty v^t \exp(-v^t + i \frac{x}{v}) dv$ , J. Math. Phys. 30, 40 (1951) (with permission).

$$27.6. f(x) = \int_0^\infty \frac{e^{-t^2}}{t+x} dt$$

**Power Series Representation**

27.6.1

$$f(x) = -e^{-x^2} \ln x + e^{-x^2} \left[ \sqrt{\pi} \sum_{k=0}^{\infty} \frac{x^{2k+1}}{k!(2k+1)} - \sum_{k=1}^{\infty} \frac{x^{2k}}{k! 2k} \frac{\gamma}{2} \right]$$

27.6.2

$$= -e^{-x^2} \ln x + \frac{1}{2} \sum_{k=0}^{\infty} \frac{(-1)^k \psi(k+1) x^{2k}}{k!} + \sqrt{\pi} \sum_{k=0}^{\infty} \frac{(-2)^k x^{2k+1}}{1 \cdot 3 \cdot 5 \dots (2k+1)}$$

(For  $\gamma$  and the digamma function  $\psi(x)$ , see chapter 6.)

**Relation to the Exponential Integral**

$$27.6.3 f(x) = -\frac{1}{2} e^{-x^2} \text{Ei}(x^2) + \sqrt{\pi} e^{-x^2} \int_0^x e^{t^2} dt$$

(For  $\text{Ei}(x)$  see chapter 5;  $e^{-x^2} \int_0^x e^{t^2} dt$ , see chapter 7.

**Asymptotic Representation**

27.6.4

$$f(x) \sim \frac{\sqrt{\pi}}{2} \left[ \frac{1}{x} + \frac{1}{2x^3} + \frac{1 \cdot 3}{4x^5} + \frac{1 \cdot 3 \cdot 5}{8x^7} + \dots \right] - \frac{1}{2} \left[ \frac{1}{x^2} + \frac{1}{x^4} + \frac{2!}{x^6} + \frac{3!}{x^8} + \dots \right] \quad (x \rightarrow \infty)$$

[27.14] A. Erdélyi, Note on the paper "On a definite integral" by R. H. Ritchie, Math. Tables Aids Comp. 4, 31, 179 (1950).

[27.15] E. T. Goodwin and J. Staton, Table of  $\int_0^\infty \frac{e^{-u^2}}{u+x} du$ , Quart. J. Mech. Appl. Math. 1, 319 (1948).  $x=0(.02)2(.05)3(.1)10$ . Auxiliary function for  $x=0(.01)1$ .

[27.16] R. H. Ritchie, On a definite integral, Math. Tables Aids Comp. 4, 30, 75 (1950).

Table 27.6

$$f(x) = \int_0^\infty \frac{e^{-t^2}}{t+x} dt$$

| $x$  | $f(x) + \ln x$ | $x$  | $f(x) + \ln x$ | $x$ | $f(x)$ | $x$ | $f(x)$ | $x$ | $f(x)$ |
|------|----------------|------|----------------|-----|--------|-----|--------|-----|--------|
| 0.00 | -0.2886        | 0.50 | 0.2704         | 1.0 | 0.6051 | 2.0 | 0.3543 | 3.0 | 0.2519 |
| 0.05 | -0.2081        | 0.55 | 0.3100         | 1.1 | 0.5644 | 2.1 | 0.3404 | 3.5 | 0.2203 |
| 0.10 | -0.1375        | 0.60 | 0.3479         | 1.2 | 0.5291 | 2.2 | 0.3276 | 4.0 | 0.1958 |
| 0.15 | -0.0735        | 0.65 | 0.3842         | 1.3 | 0.4980 | 2.3 | 0.3157 | 4.5 | 0.1762 |
| 0.20 | -0.0146        | 0.70 | 0.4192         | 1.4 | 0.4705 | 2.4 | 0.3046 | 5.0 | 0.1602 |
| 0.25 | +0.0402        | 0.75 | 0.4529         | 1.5 | 0.4460 | 2.5 | 0.2944 | 5.5 | 0.1468 |
| 0.30 | 0.0915         | 0.80 | 0.4854         | 1.6 | 0.4239 | 2.6 | 0.2848 | 6.0 | 0.1356 |
| 0.35 | 0.1398         | 0.85 | 0.5168         | 1.7 | 0.4040 | 2.7 | 0.2758 | 6.5 | 0.1259 |
| 0.40 | 0.1856         | 0.90 | 0.5472         | 1.8 | 0.3860 | 2.8 | 0.2673 | 7.0 | 0.1175 |
| 0.45 | 0.2290         | 0.95 | 0.5766         | 1.9 | 0.3695 | 2.9 | 0.2594 | 7.5 | 0.1102 |
| 0.50 | 0.2704         | 1.00 | 0.6051         | 2.0 | 0.3543 | 3.0 | 0.2519 | 8.0 | 0.1037 |

$$\left[ \begin{matrix} (-3)1 \\ 4 \end{matrix} \right]$$

$$\left[ \begin{matrix} (-4)2 \\ 3 \end{matrix} \right]$$

$$\left[ \begin{matrix} (-4)7 \\ 4 \end{matrix} \right]$$

$$\left[ \begin{matrix} (-4)1 \\ 3 \end{matrix} \right]$$

$$\left[ \begin{matrix} (-4)9 \\ 4 \end{matrix} \right]$$

Compiled from E. T. Goodwin and J. Staton, Table of  $\int_0^\infty \frac{e^{-u^2}}{u+x} du$ , Quart. J. Mech. Appl. Math. 1, 319 (1948) (with permission).

27.7. Dilogarithm

(Spence's Integral for  $n=2$ )

27.7.1  $f(x) = - \int_1^x \frac{\ln t}{t-1} dt$

Series Expansion

27.7.2  $f(x) = \sum_{k=1}^\infty (-1)^k \frac{(x-1)^k}{k^2} \quad (2 \geq x \geq 0)$

Functional Relationships

27.7.3

$$f(x) + f(1-x) = -\ln x \ln(1-x) + \frac{\pi^2}{6} \quad (1 \geq x \geq 0)$$

27.7.4

$$f(1-x) + f(1+x) = \frac{1}{2} f(1-x^2) \quad (1 \geq x > 0)$$

27.7.5  $f(x) + f\left(\frac{1}{x}\right) = -\frac{1}{2} (\ln x)^2 \quad (0 \leq x \leq 1)$

27.7.6

$$f(x+1) - f(x) = -\ln x \ln(x+1) - \frac{\pi^2}{12} - \frac{1}{2} f(x^2) \quad (2 \geq x \geq 0)$$

Relation to Debye Functions

27.7.7  $f(e^{-t}) = -f(e^t) - \frac{t^2}{2} = \int_0^t \frac{tdt}{e^t-1}$

[27.17] L. Lewin, Dilogarithms and associated functions (Macdonald, London, England, 1958).

[27.18] K. Mitchell, Tables of the function  $\int_0^x \frac{-\log|1-y|}{y} dy$ , with an account of some properties of this and related functions, Phil. Mag. 40, 351-368 (1949).  $x = -1(.01)1; x = 0(.001).5, 9D$ .

[27.19] E. O. Powell, An integral related to the radiation integrals, Phil. Mag. 7, 34, 600-607 (1943).  $\int_1^x \frac{\log y}{y-1} dy, x = 0(.01)2(.02)6, 7D$ .

[27.20] A. van Wijngaarden, Polylogarithms, by the Staff of the Computation Department, Report R24, Mathematisch Centrum, Amsterdam, Holland (1954).  $F_n(z) = \sum_{h=1}^\infty h^{-n} z^h$  for  $z = x = -1(.01)1; z = ix$ , for  $x = 0(.01)1; z = e^{i\alpha/2}$  for  $\alpha = 0(.01)2, 10D$ .



Dilogarithm

Table 27.7

$$f(x) = -\int_1^x \frac{\ln t}{t-1} dt$$

| <i>x</i> | <i>f(x)</i>  | <i>x</i> | <i>f(x)</i>  | <i>x</i> | <i>f(x)</i>  | <i>x</i> | <i>f(x)</i>  | <i>x</i> | <i>f(x)</i>  |
|----------|--------------|----------|--------------|----------|--------------|----------|--------------|----------|--------------|
| 0.00     | 1.64493 4067 | 0.10     | 1.29971 4723 | 0.20     | 1.07479 4600 | 0.30     | 0.88937 7624 | 0.40     | 0.72758 6308 |
| 0.01     | 1.58862 5448 | 0.11     | 1.27452 9160 | 0.21     | 1.05485 9830 | 0.31     | 0.87229 1733 | 0.41     | 0.71239 5042 |
| 0.02     | 1.54579 9712 | 0.12     | 1.25008 7584 | 0.22     | 1.03527 7934 | 0.32     | 0.85542 7404 | 0.42     | 0.69736 1058 |
| 0.03     | 1.50789 9041 | 0.13     | 1.22632 0101 | 0.23     | 1.01603 0062 | 0.33     | 0.83877 6261 | 0.43     | 0.68247 9725 |
| 0.04     | 1.47312 5860 | 0.14     | 1.20316 7961 | 0.24     | 0.99709 9088 | 0.34     | 0.82233 0471 | 0.44     | 0.66774 6644 |
| 0.05     | 1.44063 3797 | 0.15     | 1.18058 1124 | 0.25     | 0.97846 9393 | 0.35     | 0.80608 2689 | 0.45     | 0.65315 7631 |
| 0.06     | 1.40992 8300 | 0.16     | 1.15851 6487 | 0.26     | 0.96012 6675 | 0.36     | 0.79002 6024 | 0.46     | 0.63870 8705 |
| 0.07     | 1.38068 5041 | 0.17     | 1.13693 6560 | 0.27     | 0.94205 7798 | 0.37     | 0.77415 3992 | 0.47     | 0.62439 6071 |
| 0.08     | 1.35267 5161 | 0.18     | 1.11580 8451 | 0.28     | 0.92425 0654 | 0.38     | 0.75846 0483 | 0.48     | 0.61021 6108 |
| 0.09     | 1.32572 8728 | 0.19     | 1.09510 3088 | 0.29     | 0.90669 4053 | 0.39     | 0.74293 9737 | 0.49     | 0.59616 5361 |
| 0.10     | 1.29971 4723 | 0.20     | 1.07479 4600 | 0.30     | 0.88937 7624 | 0.40     | 0.72758 6308 | 0.50     | 0.58224 0526 |

$$\left[ \begin{matrix} (-3) \\ 2 \end{matrix} \right]$$

$$\left[ \begin{matrix} (-4) \\ 1 \end{matrix} \right]$$

$$\left[ \begin{matrix} (-5) \\ 7 \end{matrix} \right]$$

$$\left[ \begin{matrix} (-5) \\ 6 \end{matrix} \right]$$

$$\left[ \begin{matrix} (-5) \\ 5 \end{matrix} \right]$$

From K. Mitchell, Tables of the function  $\int_0^x \frac{z - \log |1-y|}{y} dy$ , with an account of some properties of this and related functions, Phil. Mag. 40, 351-368 (1949) (with permission).

27.8. Clausen's Integral and Related Summations

27.8.1

$$f(\theta) = -\int_0^\theta \ln \left( 2 \sin \frac{t}{2} \right) dt = \sum_{k=1}^{\infty} \frac{\sin k\theta}{k^2} \quad (0 \leq \theta \leq \pi)$$

Series Representation

27.8.2

$$f(\theta) = -\theta \ln |\theta| + \theta + \sum_{k=1}^{\infty} \frac{(-1)^{k-1}}{(2k)!} B_{2k} \frac{\theta^{2k+1}}{2k(2k+1)} \quad \left( 0 \leq \theta < \frac{\pi}{2} \right)$$

27.8.3

$$f(\pi - \theta) = \theta \ln 2 - \sum_{k=1}^{\infty} \frac{(-1)^{k-1}}{(2k)!} B_{2k} (2^{2k} - 1) \frac{\theta^{2k+1}}{2k(2k+1)} \quad (\pi/2 < \theta < \pi)$$

Functional Relationship

27.8.4  $f(\pi - \theta) = f(\theta) - \frac{1}{2} f(2\theta) \quad \left( 0 \leq \theta \leq \frac{\pi}{2} \right)$

Relation to Spence's Integral

27.8.5

$$if(\theta) = g(e^{i\theta}) + \frac{\theta^2}{4} \text{ where } g(x) = \int_1^x \frac{dt}{t} \ln |1+t|$$

Summable Series

27.8.6

$$\sum_{n=1}^{\infty} \frac{\cos n\theta}{n} = -\ln \left( 2 \sin \frac{\theta}{2} \right) \quad (0 < \theta < 2\pi)$$

$$\sum_{n=1}^{\infty} \frac{\cos n\theta}{n^2} = \frac{\pi^2}{6} - \frac{\pi\theta}{2} + \frac{\theta^2}{4} \quad (0 \leq \theta \leq 2\pi)$$

$$\sum_{n=1}^{\infty} \frac{\cos n\theta}{n^4} = \frac{\pi^4}{90} - \frac{\pi^2\theta^2}{12} + \frac{\pi\theta^3}{12} - \frac{\theta^4}{48} \quad (0 \leq \theta \leq 2\pi)$$

$$\sum_{n=1}^{\infty} \frac{\sin n\theta}{n} = \frac{1}{2} (\pi - \theta) \quad (0 < \theta < 2\pi)$$

$$\sum_{n=1}^{\infty} \frac{\sin n\theta}{n^3} = \frac{\pi^2\theta}{6} - \frac{\pi\theta^2}{4} + \frac{\theta^3}{12} \quad (0 \leq \theta \leq 2\pi)$$

$$\sum_{n=1}^{\infty} \frac{\sin n\theta}{n^5} = \frac{\pi^4\theta}{90} - \frac{\pi^2\theta^3}{36} + \frac{\pi\theta^4}{48} - \frac{\theta^5}{240} \quad (0 \leq \theta \leq 2\pi)$$

[27.21] A. Ashour and A. Sabri, Tabulation of the function

$$\psi(\theta) = \sum_{n=1}^{\infty} \frac{\sin n\theta}{n^2}, \text{ Math. Tables Aids Comp. 10, 54, 57-65 (1956).}$$

[27.22] T. Clausen, Über die Zerlegung reeller gebrochener Funktionen, J. Reine Angew. Math. 8, 298-300 (1832).  $x = 0^\circ (1^\circ) 180^\circ$ , 16D.

[27.23] L. B. W. Jolley, Summation of series (Chapman Publishing Co., London, England, 1925).

[27.24] A. D. Wheelon, A short table of summable series, Report No. SM-14642, Douglas Aircraft Co., Inc., Santa Monica, Calif. (1953).

Table 27.8

Clausen's Integral

$$f(\theta) = -\int_0^\theta \ln(2 \sin \frac{t}{2}) dt$$

| $\theta^\circ$ | $f(\theta) + \theta \ln \theta$ | $\theta^\circ$ | $f(\theta)$ | $\theta^\circ$ | $f(\theta)$ | $\theta^\circ$ | $f(\theta)$ | $\theta^\circ$ | $f(\theta)$ |
|----------------|---------------------------------|----------------|-------------|----------------|-------------|----------------|-------------|----------------|-------------|
| 0              | 0.000000                        | 15             | 0.612906    | 30             | 0.864379    | 60             | 1.014942    | 90             | 0.915966    |
| 1              | 0.017453                        | 16             | 0.635781    | 32             | 0.886253    | 62             | 1.014421    | 95             | 0.883872    |
| 2              | 0.034908                        | 17             | 0.657571    | 34             | 0.906001    | 64             | 1.012886    | 100            | 0.848287    |
| 3              | 0.052362                        | 18             | 0.678341    | 36             | 0.923755    | 66             | 1.010376    | 105            | 0.809505    |
| 4              | 0.069818                        | 19             | 0.698149    | 38             | 0.939633    | 68             | 1.006928    | 110            | 0.767800    |
| 5              | 0.087276                        | 20             | 0.717047    | 40             | 0.953741    | 70             | 1.002576    | 115            | 0.723427    |
| 6              | 0.104735                        | 21             | 0.735080    | 42             | 0.966174    | 72             | 0.997355    | 120            | 0.676628    |
| 7              | 0.122199                        | 22             | 0.752292    | 44             | 0.977020    | 74             | 0.991294    | 125            | 0.627629    |
| 8              | 0.139664                        | 23             | 0.768719    | 46             | 0.986357    | 76             | 0.984425    | 130            | 0.576647    |
| 9              | 0.157133                        | 24             | 0.784398    | 48             | 0.994258    | 78             | 0.976776    | 135            | 0.523889    |
| 10             | 0.174607                        | 25             | 0.799360    | 50             | 1.000791    | 80             | 0.968375    | 140            | 0.469554    |
| 11             | 0.192084                        | 26             | 0.813635    | 52             | 1.006016    | 82             | 0.959247    | 145            | 0.413831    |
| 12             | 0.209567                        | 27             | 0.827249    | 54             | 1.009992    | 84             | 0.949419    | 150            | 0.356908    |
| 13             | 0.227055                        | 28             | 0.840230    | 56             | 1.012773    | 86             | 0.938914    | 160            | 0.240176    |
| 14             | 0.244549                        | 29             | 0.852599    | 58             | 1.014407    | 88             | 0.927755    | 170            | 0.120755    |
| 15             | 0.262049                        | 30             | 0.864379    | 60             | 1.014942    | 90             | 0.915966    | 180            | 0.000000    |

$$\left[ \begin{matrix} (-7)8 \\ 3 \end{matrix} \right]$$

$$\left[ \begin{matrix} (-4)1 \\ 4 \end{matrix} \right]$$

$$\left[ \begin{matrix} (-4)3 \\ 4 \end{matrix} \right]$$

$$\left[ \begin{matrix} (-4)1 \\ 4 \end{matrix} \right]$$

$$\left[ \begin{matrix} (-4)4 \\ 6 \end{matrix} \right]$$

Compiled from A. Ashour and A. Sabri, Tabulation of the function  $\psi(\theta) = \sum_{n=1}^{\infty} \frac{\sin n\theta}{n^2}$ , Math. Tables Aids Comp. 10, 54, 57-65 (1966) (with permission).

27.9. Vector-Addition Coefficients

(Wigner coefficients or Clebsch-Gordan coefficients)

Definition

27.9.1

$$(j_1 j_2 m_1 m_2 | j_1 j_2 j m) = \delta(m, m_1 + m_2) \cdot \sqrt{\frac{(j_1 + j_2 - j)! (j + j_1 - j_2)! (j + j_2 - j_1)! (2j + 1)!}{(j + j_1 + j_2 + 1)!}}$$

$$\cdot \sum_k \frac{(-1)^k \sqrt{(j_1 + m_1)! (j_1 - m_1)! (j_2 + m_2)! (j_2 - m_2)! (j + m)! (j - m)!}}{k! (j_1 + j_2 - j - k)! (j_1 - m_1 - k)! (j_2 + m_2 - k)! (j - j_2 + m_1 + k)! (j - j_1 - m_2 + k)!}$$

$$\delta(i, k) = \begin{cases} 1, & i = k \\ 0, & i \neq k \end{cases}$$

Conditions

27.9.2  $j_1, j_2, j = +n$  or  $+\frac{n}{2}$  ( $n = \text{integer}$ )

27.9.3  $j_1 + j_2 + j = n$

27.9.4  $j_1 + j_2 - j$   
 27.9.5  $j_1 - j_2 + j$   
 27.9.6  $-j_1 + j_2 + j$  }  $\geq 0$

27.9.7  $m_1, m_2, m = \pm n$  or  $\pm \frac{n}{2}$

27.9.8  $|m_1| \leq j_1, |m_2| \leq j_2, |m| \leq j$

27.9.9  $(j_1 j_2 m_1 m_2 | j_1 j_2 j m) = 0$   $m_1 + m_2 \neq m$

Special Values

27.9.10  $(j_1 0 m_1 0 | j_1 0 j m) = \delta(j_1, j) \delta(m_1, m)$

27.9.11  $(j_1 j_2 0 0 | j_1 j_2 j 0) = 0$   $j_1 + j_2 + j = 2n + 1$

27.9.12  $(j_1 j_1 m_1 m_1 | j_1 j_1 j m) = 0$   $2j_1 + j = 2n + 1$

Symmetry Relations

27.9.13

$$(j_1 j_2 m_1 m_2 | j_1 j_2 j m)$$

$$= (-1)^{j_1+j_2-j} (j_1 j_2 - m_1 - m_2 | j_1 j_2 j - m)$$

27.9.14

$$= (j_2 j_1 - m_2 - m_1 | j_2 j_1 j - m)$$

27.9.15

$$= (-1)^{j_1+j_2-j} (j_2 j_1 m_1 m_2 | j_2 j_1 j m)$$

27.9.16

$$= \sqrt{\frac{2j+1}{2j_1+1}} (-1)^{j_2+m_2} (j j_2 - m m_2 | j j_2 j_1 - m_1)$$

27.9.17

$$= \sqrt{\frac{2j+1}{2j_1+1}} (-1)^{j_1-m_1+j-m} (j j_2 m - m_2 | j j_2 j_1 m_1)$$

27.9.18

$$= \sqrt{\frac{2j+1}{2j_1+1}} (-1)^{j-m+j_1-m_1} (j_2 j m_2 - m | j_2 j j_1 - m_1)$$

27.9.19

$$= \sqrt{\frac{2j+1}{2j_2+1}} (-1)^{j_1-m_1} (j_1 j m_1 - m | j_1 j j_2 - m_2)$$

27.9.20

$$= \sqrt{\frac{2j+1}{2j_2+1}} (-1)^{j_1-m_1} (j j_1 m - m_1 | j j_1 j_2 m_2)$$

$(j_1 \frac{1}{2} m_1 m_2 | j_1 \frac{1}{2} j m)$

Table 27.9.1

| $j =$               | $m_2 = \frac{1}{2}$                              | $m_2 = -\frac{1}{2}$                            |
|---------------------|--|---|
| $j_1 + \frac{1}{2}$ | $\sqrt{\frac{j_1 + m + \frac{1}{2}}{2j_1 + 1}}$  | $\sqrt{\frac{j_1 - m + \frac{1}{2}}{2j_1 + 1}}$ |
| $j_1 - \frac{1}{2}$ | $-\sqrt{\frac{j_1 - m + \frac{1}{2}}{2j_1 + 1}}$ | $\sqrt{\frac{j_1 + m + \frac{1}{2}}{2j_1 + 1}}$ |

$(j_1 1 m_1 m_2 | j_1 1 j m)$

Table 27.9.2

| $j =$     | $m_2 = 1$  | $m_2 = 0$   | $m_2 = -1$   |
|-----------|--|---|--|
| $j_1 + 1$ | $\sqrt{\frac{(j_1 + m)(j_1 + m + 1)}{(2j_1 + 1)(2j_1 + 2)}}$ | $\sqrt{\frac{(j_1 - m + 1)(j_1 + m + 1)}{(2j_1 + 1)(j_1 + 1)}}$ | $\sqrt{\frac{(j_1 - m)(j_1 - m + 1)}{(2j_1 + 1)(2j_1 + 2)}}$ |
| $j_1$     | $-\sqrt{\frac{(j_1 + m)(j_1 - m + 1)}{2j_1(j_1 + 1)}}$       | $\frac{m}{\sqrt{j_1(j_1 + 1)}}$                                 | $\sqrt{\frac{(j_1 - m)(j_1 + m + 1)}{2j_1(j_1 + 1)}}$        |
| $j_1 - 1$ | $\sqrt{\frac{(j_1 - m)(j_1 - m + 1)}{2j_1(2j_1 + 1)}}$       | $-\sqrt{\frac{(j_1 - m)(j_1 + m)}{j_1(2j_1 + 1)}}$              | $\sqrt{\frac{(j_1 + m + 1)(j_1 + m)}{2j_1(2j_1 + 1)}}$       |

Table 27.9.3

 $(j_1 \frac{3}{2} m_1 m_2 | j_1 \frac{3}{2} j m)$ 

| $j =$               | $m_2 = \frac{3}{2}$  | $m_2 = \frac{1}{2}$  |
|---------------------|--|--|
| $j_1 + \frac{3}{2}$ | $\sqrt{\frac{(j_1 + m - \frac{1}{2})(j_1 + m + \frac{1}{2})(j_1 + m + \frac{3}{2})}{(2j_1 + 1)(2j_1 + 2)(2j_1 + 3)}}$  | $\sqrt{\frac{3(j_1 + m + \frac{1}{2})(j_1 + m + \frac{3}{2})(j_1 - m + \frac{3}{2})}{(2j_1 + 1)(2j_1 + 2)(2j_1 + 3)}}$ |
| $j_1 + \frac{1}{2}$ | $-\sqrt{\frac{3(j_1 + m - \frac{1}{2})(j_1 + m + \frac{1}{2})(j_1 - m + \frac{3}{2})}{2j_1(2j_1 + 1)(2j_1 + 3)}}$      | $-(j_1 - 3m + \frac{3}{2})\sqrt{\frac{j_1 + m + \frac{1}{2}}{2j_1(2j_1 + 1)(2j_1 + 3)}}$                               |
| $j_1 - \frac{1}{2}$ | $\sqrt{\frac{3(j_1 + m - \frac{1}{2})(j_1 - m + \frac{1}{2})(j_1 - m + \frac{3}{2})}{(2j_1 - 1)(2j_1 + 1)(2j_1 + 2)}}$ | $-(j_1 + 3m - \frac{1}{2})\sqrt{\frac{j_1 - m + \frac{1}{2}}{(2j_1 - 1)(2j_1 + 1)(2j_1 + 2)}}$                         |
| $j_1 - \frac{3}{2}$ | $-\sqrt{\frac{(j_1 - m - \frac{1}{2})(j_1 - m + \frac{1}{2})(j_1 - m + \frac{3}{2})}{2j_1(2j_1 - 1)(2j_1 + 1)}}$       | $\sqrt{\frac{3(j_1 + m - \frac{1}{2})(j_1 - m - \frac{1}{2})(j_1 - m + \frac{1}{2})}{2j_1(2j_1 - 1)(2j_1 + 1)}}$       |
| $j =$               | $m_2 = -\frac{1}{2}$   | $m_2 = -\frac{3}{2}$   |
| $j_1 + \frac{3}{2}$ | $\sqrt{\frac{3(j_1 + m + \frac{3}{2})(j_1 - m + \frac{1}{2})(j_1 - m + \frac{3}{2})}{(2j_1 + 1)(2j_1 + 2)(2j_1 + 3)}}$ | $\sqrt{\frac{(j_1 - m - \frac{1}{2})(j_1 - m + \frac{1}{2})(j_1 - m + \frac{3}{2})}{(2j_1 + 1)(2j_1 + 2)(2j_1 + 3)}}$  |
| $j_1 + \frac{1}{2}$ | $(j_1 + 3m + \frac{3}{2})\sqrt{\frac{j_1 - m + \frac{1}{2}}{2j_1(2j_1 + 1)(2j_1 + 3)}}$                                | $\sqrt{\frac{3(j_1 + m + \frac{3}{2})(j_1 - m - \frac{1}{2})(j_1 - m + \frac{1}{2})}{2j_1(2j_1 + 1)(2j_1 + 3)}}$       |
| $j_1 - \frac{1}{2}$ | $-(j_1 - 3m - \frac{1}{2})\sqrt{\frac{j_1 + m + \frac{1}{2}}{(2j_1 - 1)(2j_1 + 1)(2j_1 + 2)}}$                         | $\sqrt{\frac{3(j_1 + m + \frac{1}{2})(j_1 + m + \frac{3}{2})(j_1 - m - \frac{1}{2})}{(2j_1 - 1)(2j_1 + 1)(2j_1 + 2)}}$ |
| $j_1 - \frac{3}{2}$ | $-\sqrt{\frac{3(j_1 + m - \frac{1}{2})(j_1 + m + \frac{1}{2})(j_1 - m - \frac{1}{2})}{2j_1(2j_1 - 1)(2j_1 + 1)}}$      | $\sqrt{\frac{(j_1 + m - \frac{1}{2})(j_1 + m + \frac{1}{2})(j_1 + m + \frac{3}{2})}{2j_1(2j_1 - 1)(2j_1 + 1)}}$        |

**Table 27.9.4**

$(j_1 \ 2 \ m_1 \ m_2 \ | \ j_1 \ 2 \ j \ m)$

| $j =$     | $m_2 = 2$  | $m_2 = 1$  | $m_2 = 0$  |
|-----------|--|--|--|
| $j_1 + 2$ | $\sqrt{\frac{(j_1 + m - 1)(j_1 + m)(j_1 + m + 1)(j_1 + m + 2)}{(2j_1 + 1)(2j_1 + 2)(2j_1 + 3)(2j_1 + 4)}}$ | $\sqrt{\frac{(j_1 - m + 2)(j_1 + m + 2)(j_1 + m + 1)(j_1 + m)}{(2j_1 + 1)(j_1 + 1)(2j_1 + 3)(j_1 + 2)}}$   | $\sqrt{\frac{3(j_1 - m + 2)(j_1 - m + 1)(j_1 + m + 2)(j_1 + m + 1)}{(2j_1 + 1)(2j_1 + 2)(2j_1 + 3)(j_1 + 2)}}$ |
| $j_1 + 1$ | $-\sqrt{\frac{(j_1 + m - 1)(j_1 + m)(j_1 + m + 1)(j_1 - m + 2)}{2j_1(j_1 + 1)(j_1 + 2)(2j_1 + 1)}}$        | $-(j_1 - 2m + 2)\sqrt{\frac{(j_1 + m + 1)(j_1 + m)}{2j_1(2j_1 + 1)(j_1 + 1)(j_1 + 2)}}$                    | $m\sqrt{\frac{3(j_1 - m + 1)(j_1 + m + 1)}{j_1(2j_1 + 1)(j_1 + 1)(j_1 + 2)}}$                                  |
| $j_1$     | $\sqrt{\frac{3(j_1 + m - 1)(j_1 + m)(j_1 - m + 1)(j_1 - m + 2)}{(2j_1 - 1)2j_1(j_1 + 1)(2j_1 + 3)}}$       | $(1 - 2m)\sqrt{\frac{3(j_1 - m + 1)(j_1 + m)}{(2j_1 - 1)j_1(2j_1 + 2)(2j_1 + 3)}}$                         | $\frac{3m^2 - j_1(j_1 + 1)}{\sqrt{(2j_1 - 1)j_1(j_1 + 1)(2j_1 + 3)}}$  |
| $j_1 - 1$ | $-\sqrt{\frac{(j_1 + m - 1)(j_1 - m)(j_1 - m + 1)(j_1 - m + 2)}{2(j_1 - 1)j_1(j_1 + 1)(2j_1 + 1)}}$        | $(j_1 + 2m - 1)\sqrt{\frac{(j_1 - m + 1)(j_1 - m)}{(j_1 - 1)j_1(2j_1 + 1)(2j_1 + 2)}}$                     | $-m\sqrt{\frac{3(j_1 - m)(j_1 + m)}{(j_1 - 1)j_1(2j_1 + 1)(j_1 + 1)}}$   |
| $j_1 - 2$ | $\sqrt{\frac{(j_1 - m - 1)(j_1 - m)(j_1 - m + 1)(j_1 - m + 2)}{(2j_1 - 2)(2j_1 - 1)2j_1(2j_1 + 1)}}$       | $-\sqrt{\frac{(j_1 - m + 1)(j_1 - m)(j_1 - m - 1)(j_1 + m - 1)}{(j_1 - 1)(2j_1 - 1)j_1(2j_1 + 1)}}$        | $\sqrt{\frac{3(j_1 - m)(j_1 - m - 1)(j_1 + m)(j_1 + m - 1)}{(2j_1 - 2)(2j_1 - 1)j_1(2j_1 + 1)}}$               |
| $j =$     | $m_2 = -1$   | $m_2 = -2$   |  |
| $j_1 + 2$ | $\sqrt{\frac{(j_1 - m + 2)(j_1 - m + 1)(j_1 - m)(j_1 + m + 2)}{(2j_1 + 1)(j_1 + 1)(2j_1 + 3)(j_1 + 2)}}$   | $\sqrt{\frac{(j_1 - m - 1)(j_1 - m)(j_1 - m + 1)(j_1 - m + 2)}{(2j_1 + 1)(2j_1 + 2)(2j_1 + 3)(2j_1 + 4)}}$ |  |
| $j_1 + 1$ | $(j_1 + 2m + 2)\sqrt{\frac{(j_1 - m + 1)(j_1 - m)}{j_1(2j_1 + 1)(2j_1 + 2)(j_1 + 2)}}$                     | $\sqrt{\frac{(j_1 - m - 1)(j_1 - m)(j_1 - m + 1)(j_1 + m + 2)}{j_1(2j_1 + 1)(j_1 + 1)(2j_1 + 4)}}$         |  |
| $j_1$     | $(2m + 1)\sqrt{\frac{3(j_1 - m)(j_1 + m + 1)}{(2j_1 - 1)j_1(2j_1 + 2)(2j_1 + 3)}}$                         | $\sqrt{\frac{3(j_1 - m - 1)(j_1 - m)(j_1 + m + 1)(j_1 + m + 2)}{(2j_1 - 1)j_1(2j_1 + 2)(2j_1 + 3)}}$       |  |
| $j_1 - 1$ | $-(j_1 - 2m - 1)\sqrt{\frac{(j_1 + m + 1)(j_1 + m)}{(j_1 - 1)j_1(2j_1 + 1)(2j_1 + 2)}}$                    | $\sqrt{\frac{(j_1 - m - 1)(j_1 + m)(j_1 + m + 1)(j_1 + m + 2)}{(j_1 - 1)j_1(2j_1 + 1)(2j_1 + 2)}}$         |  |
| $j_1 - 2$ | $-\sqrt{\frac{(j_1 - m - 1)(j_1 + m + 1)(j_1 + m)(j_1 + m - 1)}{(j_1 - 1)(2j_1 - 1)j_1(2j_1 + 1)}}$        | $\sqrt{\frac{(j_1 + m - 1)(j_1 + m)(j_1 + m + 1)(j_1 + m + 2)}{(2j_1 - 2)(2j_1 - 1)2j_1(2j_1 + 1)}}$       |  |

**Table 27.9.5** [By use of symmetry relations, coefficients may be put in standard form  $j_1 \leq j_2 \leq j$  and  $m \geq 0$ ]

| $m_2$               | $m$           | $j_1$         | $j$           | $(j_1 j_2 m_1 m_2   j_1 j_2 j m)$ |           |
|---------------------|---------------|---------------|---------------|-----------------------------------|-----------|
| $j_2 = \frac{1}{2}$ |               |               |               |                                   |           |
| $-\frac{1}{2}$      | 0             | $\frac{1}{2}$ | 1             | $\sqrt{\frac{1}{2}}$              | 0.70711   |
| $\frac{1}{2}$       | 0             | $\frac{1}{2}$ | 1             | $\sqrt{\frac{1}{2}}$              | 0.70711   |
| $\frac{1}{2}$       | 1             | $\frac{1}{2}$ | 1             |                                   | 1.00000   |
| $j_2 = 1$           |               |               |               |                                   |           |
| -1                  | 0             | 1             | 1             | $\sqrt{\frac{1}{2}}$              | 0.70711   |
| 0                   | 0             | 1             | 1             |                                   | 0.00000   |
| 1                   | 0             | 1             | 1             | $-\sqrt{\frac{1}{2}}$             | -0.70711  |
| 0                   | 1             | 1             | 1             | $\sqrt{\frac{1}{2}}$              | 0.70711   |
| 1                   | 1             | 1             | 1             | $-\sqrt{\frac{1}{2}}$             | -0.70711  |
| 0                   | $\frac{1}{2}$ | $\frac{1}{2}$ | $\frac{3}{2}$ | $\sqrt{\frac{2}{3}}$              | 0.81650   |
| 1                   | $\frac{1}{2}$ | $\frac{1}{2}$ | $\frac{3}{2}$ | $\sqrt{\frac{1}{3}}$              | 0.57735   |
| 1                   | $\frac{3}{2}$ | $\frac{1}{2}$ | $\frac{3}{2}$ |                                   | 1.00000 * |
| -1                  | 0             | 1             | 2             | $\sqrt{\frac{1}{6}}$              | 0.40825   |
| 0                   | 0             | 1             | 2             | $\sqrt{\frac{2}{3}}$              | 0.81650   |
| 1                   | 0             | 1             | 2             | $\sqrt{\frac{1}{6}}$              | 0.40825   |
| 0                   | 1             | 1             | 2             | $\sqrt{\frac{1}{2}}$              | 0.70711   |
| 1                   | 1             | 1             | 2             | $\sqrt{\frac{1}{2}}$              | 0.70711   |
| 1                   | 2             | 1             | 2             |                                   | 1.00000   |
| $j_2 = \frac{3}{2}$ |               |               |               |                                   |           |
| $-\frac{1}{2}$      | $\frac{1}{2}$ | 1             | $\frac{3}{2}$ | $\sqrt{\frac{8}{15}}$             | 0.73030   |
| $\frac{1}{2}$       | $\frac{1}{2}$ | 1             | $\frac{3}{2}$ | $-\sqrt{\frac{1}{15}}$            | -0.25820  |
| $\frac{3}{2}$       | $\frac{1}{2}$ | 1             | $\frac{3}{2}$ | $-\sqrt{\frac{2}{5}}$             | -0.63246  |
| $\frac{1}{2}$       | $\frac{3}{2}$ | 1             | $\frac{3}{2}$ | $\sqrt{\frac{2}{5}}$              | 0.63246   |
| $\frac{3}{2}$       | $\frac{3}{2}$ | 1             | $\frac{3}{2}$ | $-\sqrt{\frac{3}{5}}$             | -0.77460  |
| $-\frac{1}{2}$      | 0             | $\frac{1}{2}$ | 2             | $\sqrt{\frac{1}{2}}$              | 0.70711   |
| $\frac{1}{2}$       | 0             | $\frac{1}{2}$ | 2             | $\sqrt{\frac{1}{2}}$              | 0.70711   |
| $\frac{1}{2}$       | 1             | $\frac{1}{2}$ | 2             | $\frac{1}{2}\sqrt{3}$             | 0.86603   |
| $\frac{3}{2}$       | 1             | $\frac{1}{2}$ | 2             |                                   | 0.50000   |
| $\frac{3}{2}$       | 2             | $\frac{1}{2}$ | 2             |                                   | 1.00000   |
| $-\frac{3}{2}$      | 0             | $\frac{3}{2}$ | 2             |                                   | 0.50000   |
| $-\frac{1}{2}$      | 0             | $\frac{3}{2}$ | 2             |                                   | 0.50000   |
| $\frac{1}{2}$       | 0             | $\frac{3}{2}$ | 2             |                                   | -0.50000  |
| $\frac{3}{2}$       | 0             | $\frac{3}{2}$ | 2             |                                   | -0.50000  |
| $-\frac{1}{2}$      | 1             | $\frac{3}{2}$ | 2             | $\sqrt{\frac{1}{2}}$              | 0.70711   |
| $\frac{1}{2}$       | 1             | $\frac{3}{2}$ | 2             |                                   | 0.00000   |
| $\frac{3}{2}$       | 1             | $\frac{3}{2}$ | 2             | $-\sqrt{\frac{1}{2}}$             | -0.70711  |
| $\frac{1}{2}$       | 2             | $\frac{3}{2}$ | 2             | $\sqrt{\frac{1}{2}}$              | 0.70711   |
| $\frac{3}{2}$       | 2             | $\frac{3}{2}$ | 2             | $-\sqrt{\frac{1}{2}}$             | -0.70711  |
| $-\frac{1}{2}$      | $\frac{1}{2}$ | 1             | $\frac{5}{2}$ | $\sqrt{\frac{3}{10}}$             | 0.54772   |
| $\frac{1}{2}$       | $\frac{1}{2}$ | 1             | $\frac{5}{2}$ | $\sqrt{\frac{3}{5}}$              | 0.77460   |
| $\frac{3}{2}$       | $\frac{1}{2}$ | 1             | $\frac{5}{2}$ | $\sqrt{\frac{1}{10}}$             | 0.31623   |
| $\frac{1}{2}$       | $\frac{3}{2}$ | 1             | $\frac{5}{2}$ | $\sqrt{\frac{3}{5}}$              | 0.77460   |
| $\frac{3}{2}$       | $\frac{3}{2}$ | 1             | $\frac{5}{2}$ | $\sqrt{\frac{2}{5}}$              | 0.63246   |
| $\frac{3}{2}$       | $\frac{5}{2}$ | 1             | $\frac{5}{2}$ |                                   | 1.00000   |

Compiled from A. Simon, Numerical tables of the Clebsch-Gordan coefficients, Oak Ridge National Laboratory Report 1718, Oak Ridge, Tenn. (1954) (with permission).

- [27.25] E. U. Condon and G. A. Shortley, Theory of atomic spectra (Cambridge Univ. Press, Cambridge, England, 1935).
- [27.26] M. E. Rose, Elementary theory of angular momentum (John Wiley & Sons, Inc., New York, N. Y., 1955).
- [27.27] A. Simon, Numerical tables of the Clebsch-Gordan coefficients, Oak Ridge National Laboratory Report 1718, Oak Ridge, Tenn. (1954).  $C(j_1 j_2 j; m_1 m_2 m)$  for all angular moments  $< \frac{1}{2}, 10D$ .

\*See page II.

# 29. Laplace Transforms

## Contents

|   | Page        |
|---|-------------|
| 29.1. Definition of the Laplace Transform . . . . .   | 1020        |
| 29.2. Operations for the Laplace Transform . . . . .  | 1020        |
| 29.3. Table of Laplace Transforms . . . . .           | 1021        |
| 29.4. Table of Laplace-Stieltjes Transforms . . . . . | 1029        |
| <b>References</b> . . . . .                           | <b>1030</b> |



# 29. Laplace Transforms

## 29.1. Definition of the Laplace Transform

### One-dimensional Laplace Transform

$$29.1.1 \quad f(s) = \mathcal{L}\{F(t)\} = \int_0^{\infty} e^{-st} F(t) dt$$

$F(t)$  is a function of the real variable  $t$  and  $s$  is a complex variable.  $F(t)$  is called the original function and  $f(s)$  is called the image function. If the integral in 29.1.1 converges for a real  $s=s_0$ , i.e.,

$$\lim_{\substack{A \rightarrow 0 \\ B \rightarrow \infty}} \int_A^B e^{-s_0 t} F(t) dt$$

exists, then it converges for all  $s$  with  $\Re s > s_0$ , and the image function is a single valued analytic

function of  $s$  in the half-plane  $\Re s > s_0$ .

### Two-dimensional Laplace Transform

#### 29.1.2

$$f(u, v) = \mathcal{L}\{F(x, y)\} = \int_0^{\infty} \int_0^{\infty} e^{-ux - vy} F(x, y) dx dy$$

### Definition of the Unit Step Function

$$29.1.3 \quad u(t) = \begin{cases} 0 & (t < 0) \\ \frac{1}{2} & (t = 0) \\ 1 & (t > 0) \end{cases}$$

In the following tables the factor  $u(t)$  is to be understood as multiplying the original function  $F(t)$ .

## 29.2. Operations for the Laplace Transform<sup>1</sup>

|         | <i>Original Function</i> $F(t)$                                | <i>Image Function</i> $f(s)$  |
|---------|--|---|
| 29.2.1  | $F(t)$   | $\int_0^{\infty} e^{-st} F(t) dt$                                   |
|         | <b>Inversion Formula</b>                                       |   |
| 29.2.2  | $\frac{1}{2\pi i} \int_{c-i\infty}^{c+i\infty} e^{ts} f(s) ds$ | $f(s)$  |
|         | <b>Linearity Property</b>                                      |   |
| 29.2.3  | $AF(t) + BG(t)$  | $Af(s) + Bg(s)$   |
|         | <b>Differentiation</b>   |   |
| 29.2.4  | $F'(t)$  | $sf(s) - F(+0)$   |
| 29.2.5  | $F^{(n)}(t)$   | $s^n f(s) - s^{n-1} F(+0) - s^{n-2} F'(+0) - \dots - F^{(n-1)}(+0)$ |
|         | <b>Integration</b>   |   |
| 29.2.6  | $\int_0^t F(\tau) d\tau$                                       | $\frac{1}{s} f(s)$  |
| 29.2.7  | $\int_0^t \int_0^{\tau} F(\lambda) d\lambda d\tau$             | $\frac{1}{s^2} f(s)$  |
|         | <b>Convolution (Faltung) Theorem</b>                           |   |
| 29.2.8  | $\int_0^t F_1(t-\tau) F_2(\tau) d\tau = F_1 * F_2$             | $f_1(s) f_2(s)$   |
|         | <b>Differentiation</b>   |   |
| 29.2.9  | $-tF(t)$   | $f'(s)$   |
| 29.2.10 | $(-1)^n t^n F(t)$  | $f^{(n)}(s)$  |

<sup>1</sup> Adapted by permission from R. V. Churchill, Operational mathematics, 2d ed., McGraw-Hill Book Co., Inc., New York, N.Y., 1958.

|                | <i>Original Function</i> $F(t)$  | <i>Image Function</i> $f(s)$  |
|----------------|--|---|
|                |  | <b>Integration</b><br>$\int_s^\infty f(x)dx$  |
| <b>29.2.11</b> | $\frac{1}{t} F(t)$   |   |
|                |  | <b>Linear Transformation</b><br>$f(s-a)$  |
| <b>29.2.12</b> | $e^{at}F(t)$   |   |
| <b>29.2.13</b> | $\frac{1}{c} F\left(\frac{t}{c}\right) \quad (c>0)$                      | $f(cs)$   |
| <b>29.2.14</b> | $\frac{1}{c} e^{(b/c)t} F\left(\frac{t}{c}\right) \quad (c>0)$           | $f(cs-b)$   |
|                | <b>Translation</b>   |   |
| <b>29.2.15</b> | $F(t-b)u(t-b) \quad (b>0)$   | $e^{-bs}f(s)$   |
|                | <b>Periodic Functions</b>  |   |
| <b>29.2.16</b> | $F(t+a)=F(t)$  | $\frac{\int_0^a e^{-st}F(t)dt}{1-e^{-as}}$  |
| <b>29.2.17</b> | $F(t+a)=-F(t)$   | $\frac{\int_0^a e^{-st}F(t)dt}{1+e^{-as}}$  |
|                | <b>Half-Wave Rectification of <math>F(t)</math> in 29.2.17</b>           |   |
| <b>29.2.18</b> | $F(t) \sum_{n=0}^{\infty} (-1)^n u(t-na)$                                | $\frac{f(s)}{1-e^{-as}}$  |
|                | <b>Full-Wave Rectification of <math>F(t)</math> in 29.2.17</b>           |   |
| <b>29.2.19</b> | $ F(t) $   | $f(s) \coth \frac{as}{2}$   |
|                | <b>Heaviside Expansion Theorem</b>                                       |   |
| <b>29.2.20</b> | $\sum_{n=1}^m \frac{p(a_n)}{q'(a_n)} e^{a_n t}$                          | $\frac{p(s)}{q(s)}, q(s)=(s-a_1)(s-a_2)\dots(s-a_m)$<br>$p(s)$ a polynomial of degree $< m$ |
| <b>29.2.21</b> | $e^{at} \sum_{n=1}^r \frac{p^{(r-n)}(a)}{(r-n)!} \frac{t^{n-1}}{(n-1)!}$ | $\frac{p(s)}{(s-a)^r}$<br>$p(s)$ a polynomial of degree $< r$                               |

### 29.3. Table of Laplace Transforms<sup>2,3</sup>

For a comprehensive table of Laplace and other integral transforms see [29.9]. For a table of two-dimensional Laplace transforms see [29.11].

|               | $f(s)$          | $F(t)$ |
|---------------|-----------------|--------|
| <b>29.3.1</b> | $\frac{1}{s}$   | 1      |
| <b>29.3.2</b> | $\frac{1}{s^2}$ | $t$    |

<sup>2</sup> The numbers in bold type in the  $f(s)$  and  $F(t)$  columns indicate the chapters in which the properties of the respective higher mathematical functions are given.

<sup>3</sup> Adapted by permission from R. V. Churchill, Operational mathematics, 2d. ed., McGraw-Hill Book Co., Inc., New York, N. Y., 1958.

|         | $f(s)$   |   | $F(t)$  |
|---------|--|---|---|
| 29.3.3  | $\frac{1}{s^n} \quad (n=1, 2, 3, \dots)$                       |   | $\frac{t^{n-1}}{(n-1)!}$  |
| 29.3.4  | $\frac{1}{\sqrt{s}}$   |   | $\frac{1}{\sqrt{\pi t}}$  |
| 29.3.5  | $s^{-3/2}$   |   | $2\sqrt{t/\pi}$   |
| 29.3.6  | $s^{-(n+1/2)} \quad (n=1, 2, 3, \dots)$                        |   | $\frac{2^n t^{n-1/2}}{1 \cdot 3 \cdot 5 \dots (2n-1) \sqrt{\pi}}$     |
| 29.3.7  | $\frac{\Gamma(k)}{s^k} \quad (k > 0)$                          | 6 | $t^{k-1}$   |
| 29.3.8  | $\frac{1}{s+a}$  |   | $e^{-at}$   |
| 29.3.9  | $\frac{1}{(s+a)^2}$  |   | $te^{-at}$  |
| 29.3.10 | $\frac{1}{(s+a)^n} \quad (n=1, 2, 3, \dots)$                   |   | $\frac{t^{n-1} e^{-at}}{(n-1)!}$                                      |
| 29.3.11 | $\frac{\Gamma(k)}{(s+a)^k} \quad (k > 0)$                      | 6 | $t^{k-1} e^{-at}$   |
| 29.3.12 | $\frac{1}{(s+a)(s+b)} \quad (a \neq b)$                        |   | $\frac{e^{-at} - e^{-bt}}{b-a}$                                       |
| 29.3.13 | $\frac{s}{(s+a)(s+b)} \quad (a \neq b)$                        |   | $\frac{ae^{-at} - be^{-bt}}{a-b}$                                     |
| 29.3.14 | $\frac{1}{(s+a)(s+b)(s+c)}$<br>( $a, b, c$ distinct constants) |   | $-\frac{(b-c)e^{-at} + (c-a)e^{-bt} + (a-b)e^{-ct}}{(a-b)(b-c)(c-a)}$ |
| 29.3.15 | $\frac{1}{s^2+a^2}$  |   | $\frac{1}{a} \sin at$   |
| 29.3.16 | $\frac{s}{s^2+a^2}$  |   | $\cos at$   |
| 29.3.17 | $\frac{1}{s^2-a^2}$  |   | $\frac{1}{a} \sinh at$  |
| 29.3.18 | $\frac{s}{s^2-a^2}$  |   | $\cosh at$  |
| 29.3.19 | $\frac{1}{s(s^2+a^2)}$   |   | $\frac{1}{a^2} (1 - \cos at)$   |
| 29.3.20 | $\frac{1}{s^2(s^2+a^2)}$                                       |   | $\frac{1}{a^3} (at - \sin at)$  |
| 29.3.21 | $\frac{1}{(s^2+a^2)^2}$  |   | $\frac{1}{2a^3} (\sin at - at \cos at)$                               |

|         | $f(s)$  | $F(t)$   |    |
|---------|---|--|----|
| 29.3.22 | $\frac{s}{(s^2+a^2)^2}$                         | $\frac{t}{2a} \sin at$   |    |
| 29.3.23 | $\frac{s^2}{(s^2+a^2)^2}$                       | $\frac{1}{2a} (\sin at + at \cos at)$  |    |
| 29.3.24 | $\frac{s^2-a^2}{(s^2+a^2)^2}$                   | $t \cos at$  |    |
| 29.3.25 | $\frac{s}{(s^2+a^2)(s^2+b^2)}$ $(a^2 \neq b^2)$ | $\frac{\cos at - \cos bt}{b^2 - a^2}$  |    |
| 29.3.26 | $\frac{1}{(s+a)^2 + b^2}$                       | $\frac{1}{b} e^{-at} \sin bt$  |    |
| 29.3.27 | $\frac{s+a}{(s+a)^2 + b^2}$                     | $e^{-at} \cos bt$  |    |
| 29.3.28 | $\frac{3a^2}{s^3+a^3}$                          | $e^{-at} - e^{at} \left( \cos \frac{at\sqrt{3}}{2} - \sqrt{3} \sin \frac{at\sqrt{3}}{2} \right)$       |    |
| 29.3.29 | $\frac{4a^3}{s^4+4a^4}$                         | $\sin at \cosh at - \cos at \sinh at$  |    |
| 29.3.30 | $\frac{s}{s^4+4a^4}$                            | $\frac{1}{2a^2} \sin at \sinh at$  |    |
| 29.3.31 | $\frac{1}{s^4-a^4}$                             | $\frac{1}{2a^3} (\sinh at - \sin at)$  |    |
| 29.3.32 | $\frac{s}{s^4-a^4}$                             | $\frac{1}{2a^2} (\cosh at - \cos at)$  |    |
| 29.3.33 | $\frac{8a^3 s^2}{(s^2+a^2)^3}$                  | $(1+a^2 t^2) \sin at - at \cos at$   |    |
| 29.3.34 | $\frac{1}{s} \left( \frac{s-1}{s} \right)^n$    | $L_n(t)$   | 22 |
| 29.3.35 | $\frac{s}{(s+a)^{\frac{3}{2}}}$                 | $\frac{1}{\sqrt{\pi t}} e^{-at} (1-2at)$   |    |
| 29.3.36 | $\sqrt{s+a} - \sqrt{s+b}$                       | $\frac{1}{2\sqrt{\pi t^3}} (e^{-bt} - e^{-at})$  |    |
| 29.3.37 | $\frac{1}{\sqrt{s+a}}$                          | $\frac{1}{\sqrt{\pi t}} - a e^{a^2 t} \operatorname{erfc} a\sqrt{t}$                                   | 7  |
| 29.3.38 | $\frac{\sqrt{s}}{s-a^2}$                        | $\frac{1}{\sqrt{\pi t}} + a e^{a^2 t} \operatorname{erf} a\sqrt{t}$                                    | 7  |
| 29.3.39 | $\frac{\sqrt{s}}{s+a^2}$                        | $\frac{1}{\sqrt{\pi t}} - \frac{2a}{\sqrt{\pi}} e^{-a^2 t} \int_0^{a\sqrt{t}} e^{-\lambda^2} d\lambda$ | 7  |
| 29.3.40 | $\frac{1}{\sqrt{s}(s-a^2)}$                     | $\frac{1}{a} e^{a^2 t} \operatorname{erf} a\sqrt{t}$   | 7  |

|         | $f(s)$  | $F(t)$  |       |
|---------|---|---|-------|
| 29.3.41 | $\frac{1}{\sqrt{s}(s+a^2)}$   | $\frac{2}{a\sqrt{\pi}} e^{-a^2t} \int_0^{a\sqrt{t}} e^{-\lambda^2} d\lambda$  | 7     |
| 29.3.42 | $\frac{b^2-a^2}{(s-a^2)(b+\sqrt{s})}$                                     | $e^{a^2t} [b-a \operatorname{erf} a\sqrt{t}] - be^{b^2t} \operatorname{erfc} b\sqrt{t}$                                     | 7     |
| 29.3.43 | $\frac{1}{\sqrt{s}(\sqrt{s}+a)}$  | $e^{a^2t} \operatorname{erfc} a\sqrt{t}$  | 7     |
| 29.3.44 | $\frac{1}{(s+a)\sqrt{s+b}}$   | $\frac{1}{\sqrt{b-a}} e^{-at} \operatorname{erf} (\sqrt{b-a}\sqrt{t})$  | 7     |
| 29.3.45 | $\frac{b^2-a^2}{\sqrt{s}(s-a^2)(\sqrt{s}+b)}$                             | $e^{a^2t} \left[ \frac{b}{a} \operatorname{erf} (a\sqrt{t}) - 1 \right] + e^{b^2t} \operatorname{erfc} b\sqrt{t}$           | 7     |
| 29.3.46 | $\frac{(1-s)^n}{s^{n+\frac{1}{2}}}$                                       | $\frac{n!}{(2n)!\sqrt{\pi t}} H_{2n}(\sqrt{t})$   | 22    |
| 29.3.47 | $\frac{(1-s)^n}{s^{n+\frac{1}{2}}}$                                       | $\frac{n!}{(2n+1)!\sqrt{\pi}} H_{2n+1}(\sqrt{t})$   | 22    |
| 29.3.48 | $\frac{\sqrt{s+2a}-1}{\sqrt{s}}$  | $ae^{-at} [I_1(at) + I_0(at)]$  | 9     |
| 29.3.49 | $\frac{1}{\sqrt{s+a}\sqrt{s+b}}$  | $e^{-\frac{1}{2}(a+b)t} I_0\left(\frac{a-b}{2}t\right)$   | 9     |
| 29.3.50 | $\frac{\Gamma(k)}{(s+a)^k(s+b)^k} \quad (k>0) \quad 6$                    | $\sqrt{\pi} \left(\frac{t}{a-b}\right)^{k-\frac{1}{2}} e^{-\frac{1}{2}(a+b)t} I_{k-\frac{1}{2}}\left(\frac{a-b}{2}t\right)$ | 10    |
| 29.3.51 | $\frac{1}{(s+a)^{\frac{1}{2}}(s+b)^{\frac{1}{2}}}$                        | $te^{-\frac{1}{2}(a+b)t} \left[ I_0\left(\frac{a-b}{2}t\right) + I_1\left(\frac{a-b}{2}t\right) \right]$                    | 9     |
| 29.3.52 | $\frac{\sqrt{s+2a}-\sqrt{s}}{\sqrt{s+2a}+\sqrt{s}}$                       | $\frac{1}{t} e^{-at} I_1(at)$   | 9     |
| 29.3.53 | $\frac{(a-b)^k}{(\sqrt{s+a}+\sqrt{s+b})^{2k}} \quad (k>0)$                | $\frac{k}{t} e^{-\frac{1}{2}(a+b)t} I_k\left(\frac{a-b}{2}t\right)$   | 9     |
| 29.3.54 | $\frac{(\sqrt{s+a}+\sqrt{s})^{-2\nu}}{\sqrt{s}\sqrt{s+a}} \quad (\nu>-1)$ | $\frac{1}{a^\nu} e^{-\frac{1}{2}at} I_\nu\left(\frac{1}{2}at\right)$  | 9     |
| 29.3.55 | $\frac{1}{\sqrt{s^2+a^2}}$  | $J_0(at)$   | 9     |
| 29.3.56 | $\frac{(\sqrt{s^2+a^2}-s)^\nu}{\sqrt{s^2+a^2}} \quad (\nu>-1)$            | $a^\nu J_\nu(at)$   | 9     |
| 29.3.57 | $\frac{1}{(s^2+a^2)^k} \quad (k>0)$                                       | $\frac{\sqrt{\pi}}{\Gamma(k)} \left(\frac{t}{2a}\right)^{k-\frac{1}{2}} J_{k-\frac{1}{2}}(at)$                              | 6, 10 |

29.3.58  $f(s) = (\sqrt{s^2+a^2}-s)^k \quad (k>0)$   $F(t) = \frac{ka^k}{t} J_k(at)$  9

29.3.59  $f(s) = \frac{(s-\sqrt{s^2-a^2})^\nu}{\sqrt{s^2-a^2}} \quad (\nu>-1)$   $F(t) = a^\nu I_\nu(at)$  9

29.3.60  $f(s) = \frac{1}{(s^2-a^2)^k} \quad (k>0)$   $F(t) = \frac{\sqrt{\pi}}{\Gamma(k)} \left(\frac{t}{2a}\right)^{k-\frac{1}{2}} I_{k-\frac{1}{2}}(at)$  6, 10

29.3.61  $f(s) = \frac{1}{s} e^{-ks}$   $F(t) = u(t-k)$  

29.3.62  $f(s) = \frac{1}{s^2} e^{-ks}$   $F(t) = (t-k)u(t-k)$

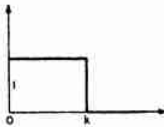
29.3.63  $f(s) = \frac{1}{s^\mu} e^{-ks} \quad (\mu>0)$   $F(t) = \frac{(t-k)^{\mu-1}}{\Gamma(\mu)} u(t-k)$  6 

29.3.64  $f(s) = \frac{1-e^{-ks}}{s}$   $F(t) = u(t) - u(t-k)$

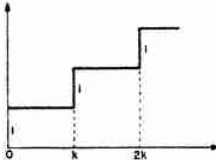
29.3.65  $f(s) = \frac{1}{s(1-e^{-ks})} = \frac{1+\coth \frac{1}{2}ks}{2s}$   $F(t) = \sum_{n=0}^{\infty} u(t-nk)$  

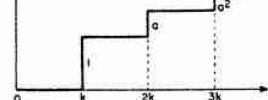
29.3.66  $f(s) = \frac{1}{s(e^{ks}-a)}$   $F(t) = \sum_{n=1}^{\infty} a^{n-1} u(t-nk)$  

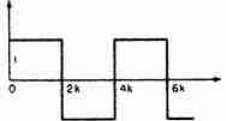
29.3.67  $f(s) = \frac{1}{s} \tanh ks$   $F(t) = u(t) + 2 \sum_{n=1}^{\infty} (-1)^n u(t-2nk)$  

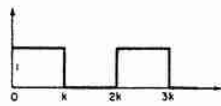
29.3.68  $f(s) = \frac{1}{s(1+e^{-ks})}$   $F(t) = \sum_{n=0}^{\infty} (-1)^n u(t-nk)$  

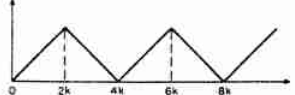
29.3.69  $f(s) = \frac{1}{s^2} \tanh ks$   $F(t) = tu(t) + 2 \sum_{n=1}^{\infty} (-1)^n (t-2nk)u(t-2nk)$  

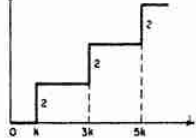
29.3.70  $f(s) = \frac{1}{s \sinh ks}$   $F(t) = 2 \sum_{n=0}^{\infty} u[t-(2n+1)k]$  

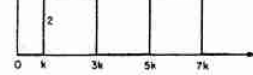
29.3.71  $f(s) = \frac{1}{s \cosh ks}$   $F(t) = 2 \sum_{n=0}^{\infty} (-1)^n u[t-(2n+1)k]$  

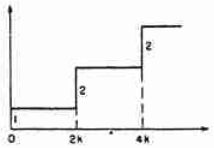
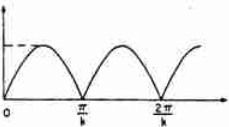
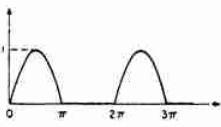
|         | $f(s)$   | $F(t)$   |   |
|---------|--|--|---|
| 29.3.72 | $\frac{1}{s} \coth ks$   | $u(t) + 2 \sum_{n=1}^{\infty} u(t-2nk)$  |    |
| 29.3.73 | $\frac{k}{s^2+k^2} \coth \frac{\pi s}{2k}$                                       | $ \sin kt $  |     |
| 29.3.74 | $\frac{1}{(s^2+1)(1-e^{-\pi s})}$  | $\sum_{n=0}^{\infty} (-1)^n u(t-n\pi) \sin t$  |  * |
| 29.3.75 | $\frac{1}{s} e^{-\frac{k}{s}}$   | $J_0(2\sqrt{kt})$  | 9   |
| 29.3.76 | $\frac{1}{\sqrt{s}} e^{-\frac{k}{s}}$  | $\frac{1}{\sqrt{\pi t}} \cos 2\sqrt{kt}$   |   |
| 29.3.77 | $\frac{1}{\sqrt{s}} e^{\frac{k}{s}}$   | $\frac{1}{\sqrt{\pi t}} \cosh 2\sqrt{kt}$  |   |
| 29.3.78 | $\frac{1}{s^{3/2}} e^{-\frac{k}{s}}$   | $\frac{1}{\sqrt{\pi k}} \sin 2\sqrt{kt}$   |   |
| 29.3.79 | $\frac{1}{s^{3/2}} e^{\frac{k}{s}}$  | $\frac{1}{\sqrt{\pi k}} \sinh 2\sqrt{kt}$  |   |
| 29.3.80 | $\frac{1}{s^\mu} e^{-\frac{k}{s}} \quad (\mu > 0)$                               | $\left(\frac{t}{k}\right)^{\frac{\mu-1}{2}} J_{\mu-1}(2\sqrt{kt})$   | 9   |
| 29.3.81 | $\frac{1}{s^\mu} e^{\frac{k}{s}} \quad (\mu > 0)$                                | $\left(\frac{t}{k}\right)^{\frac{\mu-1}{2}} I_{\mu-1}(2\sqrt{kt})$   | 9   |
| 29.3.82 | $e^{-k\sqrt{s}} \quad (k > 0)$   | $\frac{k}{2\sqrt{\pi t^3}} \exp\left(-\frac{k^2}{4t}\right)$   |   |
| 29.3.83 | $\frac{1}{s} e^{-k\sqrt{s}} \quad (k \geq 0)$                                    | $\operatorname{erfc} \frac{k}{2\sqrt{t}}$  | 7   |
| 29.3.84 | $\frac{1}{\sqrt{s}} e^{-k\sqrt{s}} \quad (k \geq 0)$                             | $\frac{1}{\sqrt{\pi t}} \exp\left(-\frac{k^2}{4t}\right)$  |   |
| 29.3.85 | $\frac{1}{s^{3/2}} e^{-k\sqrt{s}} \quad (k \geq 0)$                              | $2\sqrt{\frac{t}{\pi}} \exp\left(-\frac{k^2}{4t}\right) - k \operatorname{erfc} \frac{k}{2\sqrt{t}} = 2\sqrt{t} \operatorname{erfc} \frac{k}{2\sqrt{t}}$ | 7   |
| 29.3.86 | $\frac{1}{s^{1+\frac{1}{2}n}} e^{-k\sqrt{s}} \quad (n=0, 1, 2, \dots; k \geq 0)$ | $(4t)^{\frac{1}{2}n} \operatorname{erfc} \frac{k}{2\sqrt{t}}$  | 7   |
| 29.3.87 | $\frac{s^{-1}}{s^2} e^{-k\sqrt{s}} \quad (n=0, 1, 2, \dots; k > 0)$              | $\frac{\exp\left(-\frac{k^2}{4t}\right)}{2^n \sqrt{\pi t^{n+1}}} H_n\left(\frac{k}{2\sqrt{t}}\right)$  | 22  |
| 29.3.88 | $\frac{e^{-k\sqrt{s}}}{a+\sqrt{s}} \quad (k \geq 0)$                             | $\frac{1}{\sqrt{\pi t}} \exp\left(-\frac{k^2}{4t}\right) - a e^{ak} e^{a^2 t} \operatorname{erfc}\left(a\sqrt{t} + \frac{k}{2\sqrt{t}}\right)$           | 7   |

\*See page II.



|          | $f(s)$   |  | $F(t)$  |   |
|----------|--|--|---|---|
| 29.3.89  | $\frac{ae^{-k\sqrt{s}}}{s(a+\sqrt{s})} \quad (k \geq 0)$   |  | $-e^{ak}e^{a^2t} \operatorname{erfc}\left(a\sqrt{t} + \frac{k}{2\sqrt{t}}\right) + \operatorname{erfc} \frac{k}{2\sqrt{t}}$ | 7 |
| 29.3.90  | $\frac{e^{-k\sqrt{s}}}{\sqrt{s}(a+\sqrt{s})} \quad (k \geq 0)$                                       |  | $e^{ak}e^{a^2t} \operatorname{erfc}\left(a\sqrt{t} + \frac{k}{2\sqrt{t}}\right)$  | 7 |
| 29.3.91  | $\frac{e^{-k\sqrt{s(s+a)}}}{\sqrt{s(s+a)}} \quad (k \geq 0)$   |  | $e^{-\frac{1}{2}at} I_0\left(\frac{1}{2}a\sqrt{t^2-k^2}\right)u(t-k)$   | 9 |
| 29.3.92  | $\frac{e^{-k\sqrt{s^2+a^2}}}{\sqrt{s^2+a^2}} \quad (k \geq 0)$                                       |  | $J_0(a\sqrt{t^2-k^2})u(t-k)$  | 9 |
| 29.3.93  | $\frac{e^{-k\sqrt{s^2-a^2}}}{\sqrt{s^2-a^2}} \quad (k \geq 0)$                                       |  | $I_0(a\sqrt{t^2-k^2})u(t-k)$  | 9 |
| 29.3.94  | $\frac{e^{-k(\sqrt{s^2+a^2}-s)}}{\sqrt{s^2+a^2}} \quad (k \geq 0)$                                   |  | $J_0(a\sqrt{t^2+2kt})$  | 9 |
| 29.3.95  | $e^{-ks} - e^{-k\sqrt{s^2+a^2}} \quad (k > 0)$   |  | $\frac{ak}{\sqrt{t^2-k^2}} J_1(a\sqrt{t^2-k^2})u(t-k)$  | 9 |
| 29.3.96  | $e^{-k\sqrt{s^2-a^2}} - e^{-ks} \quad (k > 0)$   |  | $\frac{ak}{\sqrt{t^2-k^2}} I_1(a\sqrt{t^2-k^2})u(t-k)$  | 9 |
| 29.3.97  | $\frac{a^\nu e^{-k\sqrt{s^2+a^2}}}{\sqrt{s^2+a^2}(\sqrt{s^2+a^2}+s)^\nu} \quad (\nu > -1, k \geq 0)$ |  | $\left(\frac{t-k}{t+k}\right)^{\frac{\nu}{2}} J_\nu(a\sqrt{t^2-k^2})u(t-k)$   | 9 |
| 29.3.98  | $\frac{1}{s} \ln s$  |  | $-\gamma - \ln t$ ( $\gamma = .57721\ 56649 \dots$ Euler's constant)  |   |
| 29.3.99  | $\frac{1}{s^k} \ln s \quad (k > 0)$  |  | $\frac{t^{k-1}}{\Gamma(k)} [\psi(k) - \ln t]$   | 6 |
| 29.3.100 | $\frac{\ln s}{s-a} \quad (a > 0)$  |  | $e^{at}[\ln a + E_1(at)]$   | 5 |
| 29.3.101 | $\frac{\ln s}{s^2+1}$  |  | $\cos t \operatorname{Si}(t) - \sin t \operatorname{Ci}(t)$   | 5 |
| 29.3.102 | $\frac{s \ln s}{s^2+1}$  |  | $-\sin t \operatorname{Si}(t) - \cos t \operatorname{Ci}(t)$  | 5 |
| 29.3.103 | $\frac{1}{s} \ln(1+ks) \quad (k > 0)$  |  | $E_1\left(\frac{t}{k}\right)$   | 5 |
| 29.3.104 | $\ln \frac{s+a}{s+b}$  |  | $\frac{1}{t} (e^{-bt} - e^{-at})$   |   |
| 29.3.105 | $\frac{1}{s} \ln(1+k^2s^2) \quad (k > 0)$  |  | $-2 \operatorname{Ci}\left(\frac{t}{k}\right)$  | 5 |
| 29.3.106 | $\frac{1}{s} \ln(s^2+a^2) \quad (a > 0)$   |  | $2 \ln a - 2 \operatorname{Ci}(at)$   | 5 |

|          | $f(s)$  |   | $F(t)$  |   |
|----------|---|---|---|---|
| 29.3.107 | $\frac{1}{s^2} \ln (s^2+a^2) \quad (a>0)$                                     |   | $\frac{2}{a} [at \ln a + \sin at - at \operatorname{Ci}(at)]$ | 5 |
| 29.3.108 | $\ln \frac{s^2+a^2}{s^2}$   |   | $\frac{2}{t} (1 - \cos at)$                                   |   |
| 29.3.109 | $\ln \frac{s^2-a^2}{s^2}$   |   | $\frac{2}{t} (1 - \cosh at)$                                  |   |
| 29.3.110 | $\arctan \frac{k}{s}$   |   | $\frac{1}{t} \sin kt$   |   |
| 29.3.111 | $\frac{1}{s} \arctan \frac{k}{s}$   |   | $\operatorname{Si}(kt)$                                       | 5 |
| 29.3.112 | $e^{k^2 s^2} \operatorname{erfc} ks \quad (k>0)$                              | 7 | $\frac{1}{k\sqrt{\pi}} \exp\left(-\frac{t^2}{4k^2}\right)$    |   |
| 29.3.113 | $\frac{1}{s} e^{k^2 s^2} \operatorname{erfc} ks \quad (k>0)$                  | 7 | $\operatorname{erf} \frac{t}{2k}$                             | 7 |
| 29.3.114 | $e^{ks} \operatorname{erfc} \sqrt{ks} \quad (k>0)$                            | 7 | $\frac{\sqrt{k}}{\pi \sqrt{t(t+k)}}$                          |   |
| 29.3.115 | $\frac{1}{\sqrt{s}} \operatorname{erfc} \sqrt{ks} \quad (k \geq 0)$           | 7 | $\frac{1}{\sqrt{\pi t}} u(t-k)$                               |   |
| 29.3.116 | $\frac{1}{\sqrt{s}} e^{ks} \operatorname{erfc} \sqrt{ks} \quad (k \geq 0)$    | 7 | $\frac{1}{\sqrt{\pi(t+k)}}$                                   |   |
| 29.3.117 | $\operatorname{erf} \frac{k}{\sqrt{s}}$                                       | 7 | $\frac{1}{\pi t} \sin 2k\sqrt{t}$                             |   |
| 29.3.118 | $\frac{1}{\sqrt{s}} e^{\frac{k^2}{s}} \operatorname{erfc} \frac{k}{\sqrt{s}}$ | 7 | $\frac{1}{\sqrt{\pi t}} e^{-2k\sqrt{t}}$                      |   |
| 29.3.119 | $K_0(ks) \quad (k>0)$   | 9 | $\frac{1}{\sqrt{t^2-k^2}} u(t-k)$                             |   |
| 29.3.120 | $K_0(k\sqrt{s}) \quad (k>0)$  | 9 | $\frac{1}{2t} \exp\left(-\frac{k^2}{4t}\right)$               |   |
| 29.3.121 | $\frac{1}{s} e^{ks} K_1(ks) \quad (k>0)$                                      | 9 | $\frac{1}{k} \sqrt{t(t+2k)}$                                  |   |
| 29.3.122 | $\frac{1}{\sqrt{s}} K_1(k\sqrt{s}) \quad (k>0)$                               | 9 | $\frac{1}{k} \exp\left(-\frac{k^2}{4t}\right)$                |   |
| 29.3.123 | $\frac{1}{\sqrt{s}} e^{\frac{k}{s}} K_0\left(\frac{k}{s}\right) \quad (k>0)$  | 9 | $\frac{2}{\sqrt{\pi t}} K_0(2\sqrt{2kt})$                     | 9 |
| 29.3.124 | $\pi e^{-ks} I_0(ks) \quad (k>0)$   | 9 | $\frac{1}{\sqrt{t(2k-t)}} [u(t) - u(t-2k)]$                   |   |
| 29.3.125 | $e^{-ks} I_1(ks) \quad (k>0)$   | 9 | $\frac{k-t}{\pi k \sqrt{t(2k-t)}} [u(t) - u(t-2k)]$           |   |

|          | $f(s)$   |   | $F(t)$              |
|----------|--|---|---------------------|
| 29.3.126 | $e^{as}E_1(as) \quad (a>0)$  | 5 | $\frac{1}{t+a}$     |
| 29.3.127 | $\frac{1}{a}-se^{as}E_1(as) \quad (a>0)$                               | 5 | $\frac{1}{(t+a)^2}$ |
| 29.3.128 | $a^{1-n}e^{as}E_n(as) \quad (a>0; n=0, 1, 2, \dots)$                   | 5 | $\frac{1}{(t+a)^n}$ |
| 29.3.129 | $\left[\frac{\pi}{2}-\text{Si}(s)\right] \cos s + \text{Ci}(s) \sin s$ | 5 | $\frac{1}{t^2+1}$   |

29.4. Table of Laplace-Stieltjes Transforms<sup>4</sup>

|         | $\phi(s)$  | $\Phi(t)$   |
|---------|--|---|
| 29.4.1  | $\int_0^\infty e^{-st}d\Phi(t)$                            | $\Phi(t)$   |
| 29.4.2  | $e^{-ks} \quad (k>0)$                                      | $u(t-k)$  |
| 29.4.3  | $\frac{1}{1-e^{-ks}} \quad (k>0)$                          | $\sum_{n=0}^\infty u(t-nk)$   |
| 29.4.4  | $\frac{1}{1+e^{-ks}} \quad (k>0)$                          | $\sum_{n=0}^\infty (-1)^n u(t-nk)$  |
| 29.4.5  | $\frac{1}{\sinh ks} \quad (k>0)$                           | $2 \sum_{n=0}^\infty u[t-(2n+1)k]$  |
| 29.4.6  | $\frac{1}{\cosh ks} \quad (k>0)$                           | $2 \sum_{n=0}^\infty (-1)^n u[t-(2n+1)k]$   |
| 29.4.7  | $\tanh ks \quad (k>0)$                                     | $u(t) + 2 \sum_{n=1}^\infty (-1)^n u(t-2nk)$                                      |
| 29.4.8  | $\frac{1}{\sinh(ks+a)} \quad (k>0)$                        | $2 \sum_{n=0}^\infty e^{-(2n+1)a} u[t-(2n+1)k]$                                   |
| 29.4.9  | $\frac{e^{-hs}}{\sinh(ks+a)} \quad (k>0, h>0)$             | $2 \sum_{n=0}^\infty e^{-(2n+1)a} u[t-h-(2n+1)k]$                                 |
| 29.4.10 | $\frac{\sinh(hs+b)}{\sinh(ks+a)} \quad (0<h<k)$            | $\sum_{n=0}^\infty e^{-(2n+1)a} \{ e^b u[t+h-(2n+1)k] - e^{-b} u[t-h-(2n+1)k] \}$ |
| 29.4.11 | $\sum_{n=0}^\infty a_n e^{-k_n s} \quad (0<k_0<k_1<\dots)$ | $\sum_{n=0}^\infty a_n u(t-k_n)$  |

For the definition of the Laplace-Stieltjes transform see [29.7]. In practice, Laplace-Stieltjes transforms are often written as ordinary Laplace transforms involving Dirac's delta function  $\delta(t)$ . This "function" may formally be considered as

the derivative of the unit step function,  $du(t) = \delta(t) dt$ , so that  $\int_{-\infty}^x du(t) = \int_{-\infty}^x \delta(t) dt = \begin{cases} 0 & (x < 0) \\ 1 & (x > 0) \end{cases}$ . The correspondence 29.4.2, for instance, then assumes the form  $e^{-ks} = \int_0^\infty e^{-st} \delta(t-k) dt$ .

<sup>4</sup> Adapted by permission from P. M. Morse and H. Feshbach, *Methods of theoretical physics*, vols. 1, 2, McGraw-Hill Book Co., Inc., New York, N.Y., 1953.

## References

## Texts

- [29.1] H. S. Carslaw and J. C. Jaeger, *Operational methods in applied mathematics*, 2d ed. (Oxford Univ. Press, London, England, 1948).
- [29.2] R. V. Churchill, *Operational mathematics*, 2d ed. (McGraw-Hill Book Co., Inc., New York, N.Y., Toronto, Canada, London, England, 1958).
- [29.3] G. Doetsch, *Handbuch der Laplace-Transformation*, vols. I-III (Birkhäuser, Basel, Switzerland, 1950; Basel, Switzerland, Stuttgart, Germany, 1955, 1956).
- [29.4] G. Doetsch, *Einführung in Theorie und Anwendung der Laplace-Transformation* (Birkhäuser, Basel, Switzerland, Stuttgart, Germany, 1958).
- [29.5] P. M. Morse and H. Feshbach, *Methods of theoretical physics*, vols. I, II (McGraw-Hill Book Co., Inc., New York, N.Y., Toronto, Canada, London, England, 1953).
- [29.6] B. van der Pol and H. Bremmer, *Operational*

*calculus*, 2d ed. (Cambridge Univ. Press, Cambridge, England, 1955).

- [29.7] D. V. Widder, *The Laplace transform* (Princeton Univ. Press, Princeton, N.J., 1941).

## Tables

- [29.8] G. Doetsch, *Guide to the applications of Laplace transforms* (D. Van Nostrand, London, England; Toronto, Canada; New York, N.Y.; Princeton, N.J., 1961).
- [29.9] A. Erdélyi et al., *Tables of integral transforms*, vols. I, II (McGraw-Hill Book Co., Inc., New York, N.Y., Toronto, Canada, London, England, 1954).
- [29.10] W. Magnus and F. Oberhettinger, *Formulas and theorems for the special functions of mathematical physics* (Chelsea Publishing Co., New York, N.Y., 1949).
- [29.11] D. Voelker and G. Doetsch, *Die zweidimensionale Laplace-Transformation* (Birkhäuser, Basel, Switzerland, 1950).

# Subject Index

| A   |                          | Page | B   | Page               |
|---|--------------------------|------|---|--------------------|
| Adam's formulas .....   |                          | 896  | Basic numbers .....                                 | 822                |
| Airy functions .....  | 367, 446, 510, 540,      | 689  | Bateman function .....                              | 510                |
| ascending series for .....  |                          | 446  | Bernoulli numbers .....                             | 804                |
| ascending series for integrals of .....                           |                          | 447  | table of .....                                      | 810                |
| asymptotic expansions of .....                                    |                          | 448  | Bernoulli polynomials .....                         | 803                |
| asymptotic expansions of modulus and phase .....                  |                          | 449  | as sums of powers .....                             | 804                |
| asymptotic forms of integrals of .....                            |                          | 449  | coefficients of .....                               | 809                |
| asymptotic forms of related functions .....                       |                          | 450  | derivatives of .....                                | 804                |
| complex zeros and associated values of $Bi(z)$ and $Bi'(z)$ ..... |                          | 478  | differences of .....                                | 804                |
| computation of .....  |                          | 454  | expansions of .....                                 | 804                |
| computation of zeros of .....                                     |                          | 454  | Fourier expansions of .....                         | 805                |
| definitions .....   |                          | 446  | generating function for .....                       | 804                |
| differential equations .....                                      | 446, 448,                | 448  | inequalities for .....                              | 805                |
| graphs of .....   |                          | 446  | integrals involving .....                           | 805                |
| integral representations of .....                                 |                          | 447  | multiplication theorem for .....                    | 804                |
| integrals involving .....   |                          | 448  | relations with Euler polynomials .....              | 806                |
| modulus and phase .....   |                          | 449  | special values of .....                             | 805                |
| related functions .....   |                          | 448  | symbolic operations .....                           | 806                |
| relations between .....   |                          | 446  | symmetry relations .....                            | 804                |
| representations in terms of Bessel functions .....                |                          | 447  | Bessel functions                                    |                    |
| tables of .....   |                          | 475  | as parabolic cylinder functions .....               | 692, 697           |
| tables of integrals of .....                                      |                          | 478  | definite integrals .....                            | 485                |
| Wronskian for products of .....                                   |                          | 448  | modified .....                                      | 374, 509           |
| Wronskian relations .....   |                          | 446  | notation for .....                                  | 358                |
| zeros and their asymptotic expansions .....                       |                          | 450  | of fractional order .....                           | 437                |
| Airy functions and their derivatives .....                        |                          | 446  | of the first kind .....                             | 358, 509           |
| zeros and associated values of .....                              |                          | 478  | of the second kind .....                            | 358, 509           |
| Airy integrals .....  |                          | 447  | of the third kind .....                             | 358, 510           |
| Aitken's $\delta^2$ -process .....                                |                          | 18   | orthogonality properties of .....                   | 485                |
| Aitken's iteration method .....                                   |                          | 879  | representations in terms of Airy functions .....    | 447                |
| Anger's function .....  |                          | 498  | spherical .....                                     | 437, 509           |
| relation to Weber's function .....                                |                          | 498  | Bessel functions of half-integer order .....        | 437, 497           |
| Antilogarithm .....   |                          | 89   | zeros and associated values .....                   | 467                |
| Approximate values .....  |                          | 14   | zeros of the derivative and associated values ..... | 468                |
| Approximation methods .....                                       |                          | 18   | Bessel functions, integrals .....                   | 479, 485           |
| Aitken's $\delta^2$ -process .....                                |                          | 18   | asymptotic expansions .....                         | 480, 482           |
| Newton's method .....   |                          | 18   | computation of .....                                | 488                |
| regula falsi .....  |                          | 18   | convolution type .....                              | 485                |
| successive substitution .....                                     |                          | 18   | Hankel-Nicholson type .....                         | 488                |
| Argument .....  |                          | 16   | involving products of .....                         | 484                |
| Arithmetic functions .....  |                          | 826  | polynomial approximations .....                     | 481, 482           |
| table of .....  |                          | 840  | recurrence relations .....                          | 480, 483           |
| Arithmetic-geometric mean .....                                   | 571, 577, 578, 580, 598, | 601  | reduction formulas .....                            | 483                |
| Arithmetic mean .....   |                          | 10   | repeated .....                                      | 482                |
| Arithmetic progression .....                                      |                          | 10   | simple .....  | 480                |
| Associated Legendre functions .....                               |                          | 331  | tables of .....                                     | 492                |
| (see Legendre functions)  |                          |      | Weber-Schafheitlin type .....                       | 487                |
| Asymptotic expansions .....                                       |                          | 15   | Bessel functions $J_\nu(z), Y_\nu(z)$ .....         | 358, 379, 381, 385 |
|   |                          |      | addition theorems for .....                         | 363                |





|  | Page            |  | Page               |
|--|-----------------|--|--------------------|
| powers of.....   | 16              | general solution.....                    | 538                |
| roots of.....  | 17              | graphs of.....                           | 539, 541           |
| Confluent hypergeometric functions.....                | 262,            | integral representations of.....         | 539                |
| 298, 300, 362, 377, 486, 503, 686, 691, 695, 780       |                 | recurrence relations.....                | 539                |
| alternative notations for.....                         | 504             | series expansions for.....               | 538                |
| analytic continuation of.....                          | 504             | special values of.....                   | 542                |
| asymptotic expansions and limiting forms.....          | 508             | tables of.....                           | 546                |
| Barnes-type contour integrals.....                     | 506             | Wronskian relations.....                 | 539                |
| calculation of zeros and turning points of.....        | 513             | Cubic equation, solution of.....         | 17, 20             |
| computation of.....                                    | 511             | Cumulants.....                           | 928                |
| connections with Bessel functions.....                 | 506             | Cumulative distribution function         |                    |
| differential properties of.....                        | 506             | multivariate.....                        | 927                |
| expansions in series of Bessel functions.....          | 506             | univariate.....                          | 927                |
| general confluent equation.....                        | 505             | Cunningham function.....                 | 510                |
| graphing of.....                                       | 513             | Cylinder functions.....                  | 361                |
| graph of zeros of.....                                 | 513             |  |                    |
| graphs of.....   | 514             | <b>D</b>                                 |                    |
| integral representations of.....                       | 505             | Dawson's integral.....                   | 262, 298, 305, 692 |
| Kummer's equation.....                                 | 504             | graph of.....                            | 297                |
| Kummer's functions.....                                | 504             | table of.....                            | 319                |
| Kummer's transformations.....                          | 505             | Debye functions.....                     | 998                |
| recurrence relations.....                              | 506             | DeMoivre's theorem.....                  | 74, 84             |
| special cases of.....                                  | 509             | Derivatives.....                         | 11                 |
| table of.....  | 516             | of algebraic functions.....              | 11                 |
| table of zeros of.....                                 | 535             | of circular functions.....               | 77                 |
| Whittaker's equation.....                              | 505             | of hyperbolic functions.....             | 85                 |
| Whittaker's functions.....                             | 505             | of inverse circular functions.....       | 82                 |
| Wronskian relations.....                               | 505             | of inverse hyperbolic functions.....     | 88                 |
| zeros and turning values.....                          | 510             | of logarithmic functions.....            | 69                 |
| Conformal mapping.....                                 | 642             | partial.....                             | 883                |
| Conical functions.....                                 | 337             | Differences.....                         | 877                |
| Constants  |                 | central.....                             | 877                |
| mathematical.....                                      | 1               | divided.....                             | 877                |
| physical, miscellaneous.....                           | 5               | forward.....                             | 877                |
| Continued fractions.....                               | 19, 22, 68, 70, | in terms of derivatives.....             | 883                |
| 75, 81, 85, 88, 229, 258, 263, 298, 363, 932, 941, 944 |                 | mean.....                                | 877                |
| Conversion factors                                     |                 | reciprocal.....                          | 878                |
| mathematical.....                                      | 1               | Differential equations.....              | 896                |
| physical.....  | 5               | of second order with turning points..... | 450                |
| Cornish-Fisher asymptotic expansions.....              | 935             | ordinary first order.....                | 896                |
| Correlation.....                                       | 936             | solution by Adam's formulas.....         | 896                |
| Cosine integral.....                                   | 231, 510        | by Gill's method.....                    | 896                |
| asymptotic expansions of.....                          | 233             | by Milne's method.....                   | 896                |
| computation of.....                                    | 233             | by point-slope formula.....              | 896                |
| definitions.....                                       | 231             | by predictor-corrector methods.....      | 896                |
| graphs of.....   | 232             | by Runge-Kutta method.....               | 896                |
| integral representation of.....                        | 232             | solution by trapezoidal formula.....     | 896                |
| integrals involving.....                               | 232             | system of.....                           | 897                |
| rational approximations.....                           | 233             | Differentiation.....                     | 882                |
| relation to the exponential integral.....              | 232             | Everett's formula.....                   | 883                |
| series expansions for.....                             | 232             | Lagrange's formula.....                  | 882                |
| symmetry relations.....                                | 232             | Markoff's formula.....                   | 883                |
| tables of.....   | 238, 243        | Differentiation coefficients.....        | 882                |
| Coulomb wave functions.....                            | 509, 537        | table of.....                            | 914                |
| asymptotic behavior of.....                            | 542             | Digamma function.....                    | 258                |
| asymptotic expansions of.....                          | 540             | (see psi function)                       |                    |
| computation of.....                                    | 543             | Dilogarithm function.....                | 1004               |
| differential equation.....                             | 538             | Distribution functions.....              | 927                |
| expansions in terms of Airy functions.....             | 540             | asymptotic expansions of.....            | 935                |
| expansions in terms of Bessel-Clifford functions.....  | 539             | characteristics of.....                  | 928                |
| expansions in terms of spherical Bessel functions..... | 540             | continuous.....                          | 927                |



|   |               |  |                              |
|---|---------------|--|------------------------------|
| Distribution functions—Continued                | Page          |  | Page                         |
| discrete.....                                   | 927           | parameter greater than unity.....                      | 593                          |
| inequalities for.....                           | 931           | special cases of.....                                  | 594                          |
| lattice.....                                    | 927           | Elliptical coordinates.....                            | 752                          |
| one-dimensional continuous.....                 | 930           | Equianharmonic case.....                               | 652                          |
| one-dimensional discrete.....                   | 929           | Error  |                              |
| Divisor functions.....                          | 827           | absolute.....  | 14                           |
| table of.....                                   | 840           | percentage.....  | 14                           |
| Double precision operations.....                | 21            | relative.....  | 14                           |
|   |               | Error function.....                                    | 262, 297, 301, 304, 306, 509 |
| <b>E</b>  |               | altitude chart in the complex plane.....               | 298                          |
| Economization of series.....                    | 791           | asymptotic expansion of.....                           | 298                          |
| Edgeworth asymptotic expansion.....             | 935, 955      | complex zeros of.....                                  | 329                          |
| Einstein functions.....                         | 999           | continued fraction for.....                            | 298                          |
| Elliptic functions                              |               | definite and indefinite integrals related to.....      | 302                          |
| Jacobian.....                                   | 567           | derivatives of.....                                    | 298                          |
| (see Jacobian elliptic functions)               |               | graphs of.....   | 297                          |
| Weierstrass.....                                | 627           | inequalities for.....                                  | 298                          |
| (see Weierstrass elliptic functions)            |               | infinite series approximation for the complex          |                              |
| Elliptic integrals.....                         | 587           | function.....  | 299                          |
| amplitude.....                                  | 590           | integral representation of.....                        | 297                          |
| canonical forms.....                            | 589           | rational approximations.....                           | 299                          |
| characteristic.....                             | 590           | relation to the confluent hypergeometric function..... | 298                          |
| definition.....                                 | 589           | repeated integrals of.....                             | 299                          |
| graphs of the complete.....                     | 592           | series expansions for.....                             | 297                          |
| graphs of the first kind.....                   | 592, 593      | symmetry relations.....                                | 297                          |
| graphs of the incomplete.....                   | 593, 594      | table for complex arguments.....                       | 325                          |
| graphs of the second kind.....                  | 592, 594      | table of repeated integrals of.....                    | 317                          |
| graphs of the third kind.....                   | 600           | tables of.....   | 310, 312, 316                |
| modular angle.....                              | 590           | value at infinity.....                                 | 298                          |
| modulus.....                                    | 590           | Eta functions.....                                     | 577                          |
| of the first kind.....                          | 589           | Euler function.....                                    | 826                          |
| of the second kind.....                         | 589           | table of.....  | 840                          |
| of the third kind.....                          | 590, 599      | Euler-Maclaurin formulas.....                          | 806                          |
| parameter.....                                  | 590, 602      | Euler-Maclaurin summation formula.....                 | 16, 22, 806, 886             |
| reduction formulas.....                         | 589, 597      | Euler numbers.....                                     | 804                          |
| reduction to canonical form.....                | 600           | table of.....  | 810                          |
| relation to Weierstrass elliptic functions..... | 649           | Euler polynomials.....                                 | 803                          |
| tables of complete.....                         | 608           | as sums of powers.....                                 | 804                          |
| tables of the incomplete.....                   | 613           | coefficients of.....                                   | 809                          |
| tables of the third kind.....                   | 625           | derivatives of.....                                    | 804                          |
| Elliptic integrals, complete.....               | 590           | differences of.....                                    | 804                          |
| computation of.....                             | 601           | expansions of.....                                     | 804                          |
| infinite series for.....                        | 591           | Fourier expansions of.....                             | 805                          |
| Legendre's relation.....                        | 591           | generating function for.....                           | 804                          |
| limiting values.....                            | 591           | inequalities for.....                                  | 805                          |
| of the first kind.....                          | 590           | integrals involving.....                               | 805                          |
| of the second kind.....                         | 590           | multiplication theorem for.....                        | 804                          |
| of the third kind.....                          | 599, 605      | relations with Bernoulli polynomials.....              | 806                          |
| polynomial approximations.....                  | 591           | special values of.....                                 | 805                          |
| $q$ -series for.....                            | 591           | symbolic operations.....                               | 806                          |
| relation to hypergeometric functions.....       | 591           | symmetry relations.....                                | 804                          |
| Elliptic integrals, incomplete.....             | 592           | Euler summation formula.....                           | 806                          |
| amplitude of any magnitude.....                 | 592           | Euler-Totient function.....                            | 826                          |
| amplitude near $\pi/2$ .....                    | 593           | Euler's constant.....                                  | 255                          |
| complex amplitude.....                          | 592           | Euler's formula.....                                   | 74, 255                      |
| computations involving.....                     | 595, 602, 605 | Euler's integral.....                                  | 255                          |
| imaginary amplitude.....                        | 594           | Euler's transformation of series.....                  | 16, 21                       |
| Jacobi's imaginary transformation.....          | 592           | Everett interpolation coefficients.....                | 880                          |
| negative amplitude.....                         | 592           | relation to Lagrange coefficients.....                 | 880                          |
| negative parameter.....                         | 593           | Everett's formula.....                                 | 880, 883                     |
| numerical evaluation of.....                    | 595           | Excess.....  | 928                          |

|  | Page                         |  | Page               |
|--|------------------------------|--|--------------------|
| Expected value operator.....                 | 928                          | maxima and minima of.....                              | 329                |
| Exponential function.....                    | 69, 90, 509                  | rational approximations.....                           | 302                |
| Chebyshev approximation.....                 | 71                           | relation to spherical Bessel functions.....            | 301                |
| continued fractions for.....                 | 70                           | relation to the confluent hypergeometric function..... | 301                |
| differentiation formulas.....                | 71                           | relation to the error function.....                    | 301                |
| Euler's formula.....                         | 74                           | series expansion for.....                              | 301                |
| graph of.....                                | 70                           | symmetry relations.....                                | 301                |
| identities.....                              | 70                           | table of.....  | 321, 323           |
| indefinite integrals.....                    | 71                           | value at infinity.....                                 | 301                |
| inequalities for.....                        | 70                           | Fundamental period parallelogram.....                  | 629                |
| limiting values.....                         | 70                           |  |                    |
| periodic property of.....                    | 70                           | <b>G</b>   |                    |
| polynomial approximations.....               | 71                           | Gamma function.....                                    | 255, 263           |
| series expansions for.....                   | 69                           | asymptotic formulas.....                               | 257                |
| tables of.....                               | 116, 140, 219                | binomial coefficient.....                              | 256                |
| Exponential integral.....                    | 227, 262, 510                | continued fraction for.....                            | 258                |
| asymptotic expansion of.....                 | 231                          | definite integrals.....                                | 258                |
| computation of.....                          | 233                          | duplication formula.....                               | 256                |
| continued fraction for.....                  | 229                          | Euler's formula.....                                   | 255                |
| definite integrals.....                      | 230                          | Euler's infinite product.....                          | 255                |
| derivatives of.....                          | 230                          | Euler's integral.....                                  | 255                |
| graphs of.....                               | 228                          | fractional values of.....                              | 255                |
| indefinite integrals.....                    | 230                          | Gauss' multiplication formula.....                     | 256                |
| inequalities for.....                        | 229                          | graph of.....  | 255                |
| interrelations.....                          | 228                          | Hankel's contour integral.....                         | 255                |
| polynomial approximations.....               | 231                          | in the complex plane.....                              | 256                |
| rational approximations.....                 | 231                          | integer values of.....                                 | 255                |
| recurrence relations.....                    | 229                          | Pochhammer's symbol.....                               | 256                |
| relation to incomplete gamma function.....   | 230                          | polynomial approximations.....                         | 257                |
| relation to spherical Bessel functions.....  | 230                          | power series for.....                                  | 256                |
| series expansions for.....                   | 229                          | recurrence formulas.....                               | 256                |
| tables of.....                               | 238, 243, 245, 248, 249, 251 | reflection formula.....                                | 256                |
|  |                              | series expansion for $1/\Gamma(z)$ .....               | 256                |
| <b>F</b>                                     |                              | Stirling's formula.....                                | 257                |
| $F$ -distribution function.....              | 946                          | tables of.....   | 267, 272, 274, 276 |
| approximations to.....                       | 947, 948                     | triplication formulas.....                             | 256                |
| computation of.....                          | 961                          | Wallis' formula.....                                   | 258                |
| limiting forms.....                          | 947, 948                     | Gauss series.....                                      | 556                |
| non-central.....                             | 947                          | Gaussian integration.....                              | 887                |
| reflexive relation.....                      | 946                          | abscissas and weight factors for.....                  | 916                |
| relation to the $\chi^2$ -distribution.....  | 946                          | for integrands with a logarithmic singularity.....     | 920                |
| relation to Student's $t$ -distribution..... | 947                          | of moments.....  | 921                |
| series expansions for.....                   | 946, 948                     | Gaussian probability function.....                     | 931                |
| statistical properties of.....               | 946                          | Gauss' transformation.....                             | 573                |
| Factorial function.....                      | 255                          | Gegenbauer polynomials.....                            | 561                |
| (see gamma function)                         |                              | (see orthogonal polynomials)                           |                    |
| Factorization.....                           |                              | coefficients for and $x^n$ in terms of.....            | 794                |
| table of.....                                | 844, 864                     | graphs of.....   | 776                |
| Faltung theorem.....                         | 1020                         | Generalized hypergeometric function.....               | 362, 377, 556      |
| Filon's quadrature formula.....              | 890                          | Generalized Laguerre polynomials.....                  | 771                |
| coefficients for.....                        | 924                          | (see orthogonal polynomials)                           |                    |
| Floquet's theorem.....                       | 727                          | Generalized mean.....                                  | 10                 |
| Fresnel integrals.....                       | 262, 300, 440                | Geometric mean.....                                    | 10                 |
| asymptotic expansions of.....                | 302                          | Geometric progression.....                             | 10                 |
| auxiliary functions.....                     | 300, 323                     | Gill's method.....                                     | 896                |
| complex zeros of.....                        | 329                          | Gudermannian.....                                      | 77                 |
| definition.....                              | 300                          |  |                    |
| derivatives of.....                          | 301                          | <b>H</b>   |                    |
| graph of.....                                | 301                          | Hankel functions.....                                  | 358, 379, 510      |
| integrals involving.....                     | 303                          | Hankel's contour integral.....                         | 255                |
| interrelations.....                          | 300                          | Harmonic analysis.....                                 | 202, 881           |

|  | Page               |  | Page               |
|--|--------------------|--|--------------------|
| Harmonic mean.....                             | 10                 | recurrence formulas.....   | 263, 944           |
| Haversine.....                                 | 78                 | relation to other functions.....                                   | 945                |
| Heaviside expansion theorem.....               | 1021               | relation to the binomial expansion.....                            | 263                |
| Hermite functions.....                         | 509, 691           | relation to the $\chi^2$ -distribution.....                        | 944                |
| Hermite integration.....                       | 890                | relation to the hypergeometric function.....                       | 263                |
| abscissas and weight factors for.....          | 924                | series expansion for.....  | 944                |
| Hermite polynomials.....                       | 300, 510, 691, 775 | symmetry relation.....   | 263                |
| (see orthogonal polynomials)                   |                    | Incomplete gamma function.....                                     | 230, 260, 486, 509 |
| coefficients for and $x^n$ in terms of.....    | 801                | as a confluent hypergeometric function.....                        | 262                |
| graph of.....                                  | 780                | asymptotic expansions of.....                                      | 263                |
| values of.....                                 | 802                | computation of.....  | 959                |
| Heuman's lambda function.....                  | 595                | continued fraction for.....  | 263                |
| graph of.....                                  | 595                | definite integrals.....  | 263                |
| table of.....                                  | 622                | derivatives and differential equations.....                        | 262                |
| $Hh$ function.....                             | 300, 691           | graph of.....  | 261                |
| Hölder's inequality for integrals.....         | 11                 | Pearson's form of.....   | 262                |
| for sums.....                                  | 11                 | recurrence formulas.....   | 262                |
| Horner's scheme.....                           | 788                | series developments for.....                                       | 262                |
| Hyperbolic functions.....                      | 83                 | special values of.....   | 262                |
| addition and subtraction of.....               | 84                 | table of.....  | 978                |
| addition formulas for.....                     | 83                 | Indeterminate forms (L'Hospital's rule).....                       | 13                 |
| continued fraction for.....                    | 85                 | Inequality, Cauchy's.....  | 11                 |
| DeMoivre's theorem.....                        | 84                 | Chebyshev's.....   | 11                 |
| differentiation formulas.....                  | 85                 | Hölder's for integrals.....  | 11                 |
| graph of.....                                  | 83                 | Hölder's for sums.....   | 11                 |
| half-angle formulas.....                       | 83                 | Minkowski's for integrals.....                                     | 11                 |
| indefinite integrals.....                      | 86                 | Minkowski's for sums.....  | 11                 |
| infinite products.....                         | 85                 | Schwarz's.....   | 11                 |
| modulus and phase.....                         | 84                 | triangle.....  | 11                 |
| multiple angle formulas.....                   | 84                 | Integral of a bivariate normal distribution over a<br>polygon..... | 956                |
| negative angle formulas.....                   | 83                 | Integrals.....   |                    |
| periodic properties of.....                    | 83                 | of circular functions.....   | 77                 |
| products of.....                               | 84                 | of exponential functions.....                                      | 71                 |
| real and imaginary parts.....                  | 84                 | of hyperbolic functions.....                                       | 86                 |
| relations between.....                         | 83                 | of inverse circular functions.....                                 | 82                 |
| relation to circular functions.....            | 83                 | of inverse hyperbolic functions.....                               | 88                 |
| series expansions for.....                     | 85                 | of irrational algebraic functions.....                             | 12                 |
| tables of.....                                 | 213, 219           | of logarithmic functions.....                                      | 69                 |
| Hypergeometric differential equation.....      | 562                | of rational algebraic functions.....                               | 12                 |
| solution of.....                               | 563                | Integration.....   | 885                |
| Hypergeometric functions.....                  | 332,               | Bode's rule.....   | 886                |
| 335, 336, 362, 377, 487, 555, 779              |                    | by parts.....  | 12                 |
| as Legendre functions.....                     | 561                | Chebyshev's equal weight formula.....                              | 887                |
| as polynomials.....                            | 561                | Euler-Maclaurin summation formula.....                             | 886                |
| as reductions of Riemann's $P$ -function.....  | 565                | Filon's formula.....   | 890                |
| asymptotic expansions of.....                  | 565                | five-point rule for analytic functions.....                        | 887                |
| differentiation formulas.....                  | 557                | Gaussian type formulas.....  | 887                |
| Gauss series.....                              | 556                | iterated integrals.....  | 891                |
| Gauss' relations for contiguous functions..... | 557                | Lagrange formula.....  | 886                |
| integral representations.....                  | 558                | Lobatto's integration formula.....                                 | 888                |
| special cases of.....                          | 561                | multidimensional.....  | 891                |
| special elementary cases.....                  | 556                | Newton-Cotes formula.....  | 886                |
| special values of the argument.....            | 556                | Radau's integration formula.....                                   | 888                |
| transformation formulas.....                   | 559                | Simpson's rule.....  | 886                |
|  |                    | trapezoidal rule.....  | 885                |
|  |                    | Interpolation.....   | 878                |
|  |                    | Aitken's iteration method.....                                     | 879                |
| Incomplete beta function.....                  | 263, 944           | Bessel's formula.....  | 881                |
| approximations to.....                         | 945                | bivariate.....   | 882                |
| asymptotic expansions of.....                  | 945                | Everett's formula.....   | 880                |
| computation of.....                            | 959                |  |                    |
| continued fraction for.....                    | 944                |  |                    |

|  | Page       |  | Page          |
|--|------------|--|---------------|
| harmonic analysis.....                                   | 881        | quarter periods.....                                     | 569           |
| inverse.....   | 881        | reciprocal parameter.....                                | 573           |
| Lagrange formula.....                                    | 878        | relations between squares of the functions.....          | 573           |
| Newton's divided difference formula.....                 | 880        | relation to the copolar trio.....                        | 570           |
| Newton's forward difference formula.....                 | 880        | relation with Weierstrass functions.....                 | 649           |
| Taylor's expansion.....                                  | 880        | series expansions in terms of the nome $q$ .....         | 575           |
| Thiele's formula.....                                    | 881        | special arguments.....                                   | 571           |
| throwback formulas.....                                  | 880        | Jacobi's eta function.....                               | 577           |
| trigonometric.....                                       | 881        | Jacobi's polynomials.....                                | 561, 773      |
| Invariants.....  | 629        | (see orthogonal polynomials)                             |               |
| tables of.....   | 680        | coefficients for.....                                    | 793           |
| Inverse circular functions.....                          | 22, 79, 92 | graphs of.....   | 773, 776      |
| addition and subtraction of.....                         | 80         | Jacobi's theta function (see theta functions).....       | 576           |
| Chebyshev approximations.....                            | 82         | Jacobi's zeta function.....                              | 578, 595      |
| continued fractions for.....                             | 81         | addition theorem for.....                                | 595           |
| differentiation formulas.....                            | 82         | calculation by use of the arithmetic-geometric mean..... | 578           |
| graph of.....  | 79         | graph of.....  | 595           |
| indefinite integrals.....                                | 82         | Jacobi's imaginary transformation.....                   | 595           |
| logarithmic representation.....                          | 80         | $q$ -series for.....                                     | 595           |
| negative arguments.....                                  | 80         | relation to theta functions.....                         | 578, 595      |
| polynomial approximations.....                           | 81         | special values.....                                      | 595           |
| real and imaginary parts.....                            | 80         | table of.....  | 619           |
| relation to inverse hyperbolic functions.....            | 80         |  |               |
| series expansions for.....                               | 81         | <b>K</b>   |               |
| table of.....  | 203        | Kelvin functions.....                                    | 379, 387, 509 |
| Inverse hyperbolic functions.....                        | 86, 93     | ascending series for.....                                | 379           |
| addition and subtraction of.....                         | 87         | ascending series for products of.....                    | 381           |
| continued fractions for.....                             | 88         | asymptotic expansions for large arguments.....           | 381           |
| differentiation formulas.....                            | 88         | asymptotic expansions for large zeros.....               | 383           |
| graphs of.....   | 86         | asymptotic expansions of modulus and phase.....          | 383           |
| indefinite integrals.....                                | 88         | asymptotic expansions of products.....                   | 383           |
| logarithmic representations.....                         | 87         | definitions.....   | 379           |
| negative arguments.....                                  | 87         | differential equations.....                              | 379           |
| relation to inverse circular functions.....              | 87         | expansions in series of Bessel functions.....            | 381           |
| series expansions for.....                               | 88         | graphs of.....   | 382           |
| tables of.....   | 221        | indefinite integrals.....                                | 380           |
| <b>J</b>   |            | modulus and phase.....                                   | 382           |
| Jacobian elliptic functions.....                         | 567        | of negative argument.....                                | 380           |
| addition theorems for.....                               | 574        | polynomial approximations.....                           | 384           |
| approximations in terms of circular functions.....       | 573        | recurrence relations.....                                | 380           |
| approximations in terms of hyperbolic functions.....     | 574        | recurrence relations for products.....                   | 380           |
| calculation by use of the arithmetic-geometric mean..... | 571        | relations between.....                                   | 379           |
| calculation of.....                                      | 579, 581   | tables of.....   | 430           |
| change of argument.....                                  | 572        | uniform asymptotic expansions for large orders.....      | 384           |
| change of parameter.....                                 | 573        | zeros of functions of order zero.....                    | 381           |
| classification of.....                                   | 570        | Kronecker delta.....                                     | 822           |
| complex arguments.....                                   | 575        | Kummer functions.....                                    | 504           |
| definitions.....   | 569        | Kummer's transformation of series.....                   | 16            |
| derivatives of.....                                      | 574        | <b>L</b>   |               |
| double arguments.....                                    | 574        | Lagrange differentiation formula.....                    | 882           |
| graphs of.....   | 570        | Lagrange integration coefficients.....                   | 886           |
| half-arguments.....                                      | 574        | table of.....  | 915           |
| integrals.....   | 575        | Lagrange interpolation coefficients.....                 | 878           |
| integrals of the squares.....                            | 576        | table of.....  | 900           |
| Jacobi's imaginary transformation.....                   | 574        | Lagrange interpolation formula.....                      | 878           |
| Landen transformation.....                               | 573        | Lagrange's expansion.....                                | 14            |
| leading terms of series in powers of $u$ .....           | 575        | Laguerre integration.....                                | 890           |
| parameter.....   | 569        | abscissas and weight factors for.....                    | 923           |
| principal terms.....                                     | 572        |  |               |



|   | Page                    |  | Page          |
|---|-------------------------|--|---------------|
| Laguerre polynomials.....                   | 509, 510, 773           | continued fractions for.....                             | 68            |
| (see orthogonal polynomials)                |                         | definite integrals.....                                  | 69            |
| coefficients for and $x^n$ in terms of..... | 799                     | differentiation formula.....                             | 69            |
| graph of.....                               | 780                     | graph of.....  | 67            |
| values of.....                              | 800                     | indefinite integrals.....                                | 69            |
| Lamé's equation.....                        | 641                     | inequalities for.....                                    | 68            |
| Landen's transformation                     |                         | limiting values.....                                     | 68            |
| ascending.....                              | 573, 598, 604           | mantissa.....  | 89            |
| descending.....                             | 573, 597, 604           | polynomial approximations.....                           | 68            |
| Laplace transforms.....                     | 1019                    | series expansions for.....                               | 68            |
| definition.....                             | 1020                    | tables of.....   | 95            |
| operations.....                             | 1020                    | Logarithmic integral.....                                | 228, 231, 510 |
| tables of.....                              | 1021                    | graph of.....  | 231           |
| Laplace-Stieltjes transforms.....           | 1029                    |  |               |
| tables of.....                              | 1029                    | M  |               |
| Laplace's equation.....                     | 17                      | Markoff's differentiation formula.....                   | 883           |
| Laplacian.....                              | 885                     | Mathematical constants.....                              | 1             |
| in spherical coordinates.....               | 752                     | in octal scale.....                                      | 1017          |
| Laurent series.....                         | 635                     | Mathieu functions.....                                   | 721           |
| Least square approximations.....            | 790                     | asymptotic representations of.....                       | 740           |
| Legendre functions.....                     | 332, 362, 377, 561, 774 | comparative notation for.....                            | 744           |
| asymptotic expansions of.....               | 335                     | expansions for small $q$ .....                           | 730           |
| computation of.....                         | 339                     | expansions in terms of parabolic cylinder functions..... | 742           |
| explicit expressions for.....               | 333                     | graphs of.....   | 725, 734      |
| graphs of.....                              | 338, 780                | integral equations for.....                              | 735           |
| integral representations of.....            | 335                     | integral representations of.....                         | 736           |
| integrals involving.....                    | 337                     | joining factors, table of.....                           | 748           |
| notation for.....                           | 332                     | normalization of.....                                    | 732           |
| of negative argument.....                   | 333                     | orthogonality properties of.....                         | 732           |
| of negative degree.....                     | 333                     | other properties of.....                                 | 735, 738      |
| of negative order.....                      | 333                     | power series in $q$ for periodic solutions.....          | 725           |
| recurrence relations.....                   | 333                     | proportionality factors.....                             | 735           |
| relation to elliptic integrals.....         | 337                     | recurrence relations among the coefficients.....         | 723           |
| relations between.....                      | 333                     | special cases of.....                                    | 728           |
| Rodrigues' formula.....                     | 334                     | special values of.....                                   | 740           |
| special values of.....                      | 334                     | table of coefficients for.....                           | 750           |
| summation formulas.....                     | 335                     | table of critical values of.....                         | 748           |
| tables of.....                              | 342                     | zeros of.....  | 739           |
| trigonometric expansions of.....            | 335                     | Mathieu's equation.....                                  | 722           |
| values on the cut.....                      | 333                     | characteristic exponent.....                             | 727           |
| Wronskian relation.....                     | 333                     | generation of.....                                       | 727           |
| Legendre polynomials.....                   | 332, 486, 773           | graphs of.....   | 728           |
| (see orthogonal polynomials)                |                         | characteristic values.....                               | 722, 748      |
| coefficients for and $x^n$ in terms of..... | 798                     | asymptotic expansions of.....                            | 726           |
| graph of.....                               | 338, 780                | determination of.....                                    | 722           |
| values of.....                              | 342                     | graph of.....  | 724           |
| Legendre's differential equation.....       | 332                     | power series for.....                                    | 724           |
| solutions of.....                           | 332                     | Floquet solutions.....                                   | 727           |
| Leibniz' theorem for                        |                         | other solutions.....                                     | 730           |
| differentiation of a product.....           | 12                      | relation to spheroidal wave equation.....                | 722           |
| differentiation of an integral.....         | 11                      | solutions involving products of Bessel functions.....    | 731           |
| Lemniscate constant.....                    | 658                     | stability regions of.....                                | 728           |
| Lemniscatic case.....                       | 658                     | Mathieu's modified equation.....                         | 722           |
| L'Hospital's rule.....                      | 13                      | radial solutions of.....                                 | 732           |
| Lobatto integration.....                    | 888                     | Maxima.....  | 14            |
| abscissas and weight factors for.....       | 920                     | Mean.....  | 928           |
| Logarithmic function.....                   | 67, 89                  | arithmetic.....  | 10            |
| change of base.....                         | 67, 89                  | generalized.....   | 10            |
| characteristic.....                         | 89                      | geometric.....   | 10            |
| Chebyshev approximations.....               | 69                      | harmonic.....  | 10            |
| common.....                                 | 68, 89                  |  |               |

|  | Page          |   | Page          |
|--|---------------|---|---------------|
| Milne's method.....                                      | 896           | Multinomial coefficients.....                               | 823           |
| Minima.....  | 14            | table of.....   | 831           |
| Minkowski's inequality for integrals.....                | 11            |   |               |
| for sums.....  | 11            | N   |               |
| Miscellaneous functions.....                             | 997           | Neumann's polynomial.....                                   | 363           |
| Möbius function.....                                     | 826           | Neville's notation.....                                     | 578           |
| Modified Bessel functions, $I_\nu(z)$ , $K_\nu(z)$ ..... | 374           | Neville's theta functions.....                              | 578           |
| analytic continuation of.....                            | 376           | expression as infinite products.....                        | 579           |
| ascending series for.....                                | 375           | expression as infinite series.....                          | 579           |
| asymptotic expansions for large arguments.....           | 377           | graphs of.....  | 578           |
| connection with Legendre functions.....                  | 377           | tables of.....  | 582           |
| derivatives with respect to order.....                   | 377           | Newton coefficients.....                                    | 880           |
| differential equation.....                               | 374           | relation to Lagrange coefficients.....                      | 880           |
| formulas for derivatives.....                            | 376           | Newton interpolation formula.....                           | 880, 883      |
| generating function and associated series.....           | 376           | Newton's method of approximation.....                       | 18            |
| graphs of.....   | 374           | Newton-Cotes formula.....                                   | 886           |
| in terms of hypergeometric functions.....                | 377           | Nome.....   | 591, 602      |
| integral representations of.....                         | 376           | table of.....   | 608, 610, 612 |
| limiting forms for small arguments.....                  | 375           | Normal probability density function                         |               |
| multiplication theorems for.....                         | 377           | derivatives of.....   | 933           |
| Neumann series for $K_\nu(z)$ .....                      | 377           | Normal probability function.....                            | 931           |
| other differential equations.....                        | 377           | asymptotic expansions of.....                               | 932           |
| polynomial approximations.....                           | 378           | bounds for.....   | 933           |
| recurrence relations.....                                | 376           | computation of.....   | 953           |
| relations between.....                                   | 375           | continued fraction for.....                                 | 932           |
| tables of.....   | 416           | error curves for.....                                       | 933           |
| uniform asymptotic expansions for large orders.....      | 378           | polynomial and rational approximations.....                 | 932           |
| Wronskian relations.....                                 | 375           | power series for.....                                       | 932           |
| zeros of.....  | 377           | relation to other functions.....                            | 934           |
| Modified Mathieu functions.....                          | 722           | values of $x$ for extreme values of $P(x)$ and $Q(x)$ ..... | 977           |
| graphs of.....   | 734           | values of $x$ in terms of $P(x)$ and $Q(x)$ .....           | 976           |
| Modified spherical Bessel functions.....                 | 443, 453, 498 | values of $Z(x)$ in terms of $P(x)$ and $Q(x)$ .....        | 975           |
| addition theorems for.....                               | 445           | Normal probability functions and derivatives.....           | 933           |
| ascending series for.....                                | 443           | tables of.....  | 966           |
| computation of.....                                      | 453           | Normal probability integral                                 |               |
| definitions.....   | 443           | repeated integrals of.....                                  | 934           |
| degenerate forms.....                                    | 445           | Number theoretic functions.....                             | 826           |
| derivatives with respect to order.....                   | 445           |   |               |
| differential equation.....                               | 443           | O   |               |
| differentiation formulas.....                            | 444           | Oblate spheroidal coordinates.....                          | 752           |
| duplication formula.....                                 | 445           | Octal scale.....  | 1017          |
| formulas of Rayleigh's type.....                         | 445           | Octal tables.....   | 1017          |
| generating functions for.....                            | 445           | Operations with series.....                                 | 15            |
| graphs of.....   | 444           | Orthogonal polynomials.....                                 | 771           |
| recurrence relations.....                                | 444           | as confluent hypergeometric functions.....                  | 780           |
| representations by elementary functions.....             | 443           | as hypergeometric functions.....                            | 779           |
| tables of.....   | 469           | as Legendre functions.....                                  | 780           |
| Wronskian relations.....                                 | 443           | as parabolic cylinder functions.....                        | 780           |
| Modified Struve functions.....                           | 498           | change of interval of orthogonality.....                    | 790           |
| asymptotic expansion for large $ z $ .....               | 498           | coefficients for.....                                       | 793           |
| computation of.....                                      | 499           | definition.....   | 773           |
| graph of.....  | 498           | differential equations.....                                 | 773, 781      |
| integral representations of.....                         | 498           | differential relations.....                                 | 783           |
| integrals.....   | 498           | evaluation of.....  | 788           |
| power series expansion for.....                          | 498           | explicit expressions for.....                               | 775           |
| recurrence relations.....                                | 498           | generating functions for.....                               | 783           |
| relation to modified spherical Bessel functions.....     | 498           | graphs of.....  | 773, 776-780  |
| tables of.....   | 501           | inequalities for.....                                       | 786           |
| Modulus.....   | 16            | integral representations of.....                            | 784           |
| Moments.....   | 928           | integrals involving.....                                    | 785           |
| Multidimensional integration.....                        | 891           | interrelations.....   | 777           |

|  | Page               |  | Page     |
|--|--------------------|--|----------|
| Orthogonal polynomials—Continued                                 |                    |  |          |
| limit relations.....   | 787                | unrestricted.....                                  | 825      |
| of a discrete variable.....                                      | 788                | Pearson's form of the incomplete gamma function..  | 262      |
| orthogonality relations.....                                     | 774                | Pentagamma function.....                           | 260      |
| powers of $x$ in terms of.....                                   | 793, 794–801       | (see polygamma functions)                          |          |
| recurrence relations, miscellaneous.....                         | 773, 782           | Percentage points of the $\chi^2$ -distribution    |          |
| recurrence relations with respect to degree $n$ .....            | 782                | values of $\chi^2$ in terms of $Q$ and $\nu$ ..... | 984      |
| Rodrigues' formula.....  | 773, 785           | Percentage points of the $F$ -distribution         |          |
| special values of.....   | 777                | values of $F$ in terms of $Q, \nu_1, \nu_2$ .....  | 986      |
| sum formulas.....  | 785                | Percentage points of the $t$ -distribution         |          |
| tables of.....   | 795, 796, 800, 802 | values of $t$ in terms of $A$ and $\nu$ .....      | 990      |
| zeros of.....  | 787                | Planck's radiation function.....                   | 999      |
| <b>P</b>   |                    |  |          |
| Parabolic cylinder functions $U(a, x), V(a, x)$ .....            | 300, 509, 685, 780 | Plane triangles, solution of.....                  | 78, 92   |
| asymptotic expansions of.....                                    | 689                | Pochhammer's symbol.....                           | 256      |
| computation of.....  | 697                | Point-slope formula.....                           | 896      |
| connection with Bessel functions.....                            | 692, 697           | Poisson-Charlier function.....                     | 509      |
| connection with confluent hypergeometric functions.....          | 691                | Poisson distribution.....                          | 959      |
| connection with Hermite polynomials and functions.....           | 691                | table of cumulative sums of.....                   | 978      |
| connection with probability integrals and Dawson's integral..... | 691                | Polar form.....                                    | 16       |
| Darwin's expansions.....   | 689                | Polygamma functions.....                           | 260      |
| differential equation.....                                       | 686                | asymptotic formulas.....                           | 260      |
| expansions for $a$ large, $x$ moderate.....                      | 689                | fractional values of.....                          | 260      |
| expansions for $x$ large, $a$ moderate.....                      | 689                | integer values of.....                             | 260      |
| expansions in terms of Airy functions.....                       | 689                | multiplication formula for.....                    | 260      |
| integral representations of.....                                 | 687                | recurrence formula.....                            | 260      |
| modulus and phase.....   | 690                | reflection formula.....                            | 260      |
| power series in $x$ for.....                                     | 686                | series expansions for.....                         | 260      |
| recurrence relations.....  | 688                | tables of.....                                     | 267, 271 |
| standard solutions.....  | 687                | Polynomial evaluation.....                         | 788      |
| table of.....  | 700                | Powers   |          |
| Wronskian and other relations.....                               | 687                | computation of.....                                | 19, 90   |
| zeros of.....  | 696                | general.....                                       | 69       |
| Parabolic cylinder functions $W(a, x)$ .....                     | 692                | graph of.....                                      | 19       |
| asymptotic expansions of.....                                    | 693                | of complex numbers.....                            | 16       |
| complex solutions.....   | 693                | of two.....  | 1016     |
| computation of.....  | 699                | of $x^n/n!$ .....                                  | 818      |
| connection with Bessel functions.....                            | 695                | tables of.....                                     | 24       |
| connection with confluent hypergeometric functions.....          | 695                | Predictor-corrector method.....                    | 896      |
| Darwin's expansions.....   | 694                | Primes.....  | 231      |
| differential equation.....                                       | 686, 692           | table of.....                                      | 870      |
| expansions for $a$ large, $x$ moderate.....                      | 694                | Primitive roots.....                               | 827      |
| expansions for $x$ large, $a$ moderate.....                      | 693                | table of.....                                      | 864      |
| expression in terms of Airy functions.....                       | 693                | Probability density function.....                  | 931      |
| integral representations of.....                                 | 693                | asymptotic expansion of.....                       | 935      |
| modulus and phase.....   | 695                | Probability functions.....                         | 927      |
| power series in $x$ for.....                                     | 692                | Probability integral.....                          | 262, 691 |
| standard solutions.....  | 692                | of the $\chi^2$ -distribution, table of.....       | 978      |
| table of.....  | 712                | Progressions                                       |          |
| Wronskian and other relations.....                               | 693                | arithmetic.....                                    | 10       |
| zeros of.....  | 696                | geometric.....                                     | 10       |
| Parameter $m$ .....  | 569, 602           | Prolate spheroidal coordinates.....                | 752      |
| table of.....  | 612                | Pseudo-lemniscatic case.....                       | 662      |
| Partitions.....  | 825                | Psi function.....                                  | 258, 264 |
| into distinct parts.....   | 825                | asymptotic formulas.....                           | 259      |
| tables of.....   | 831, 836           | definite integrals.....                            | 259      |
|  |                    | duplication formula.....                           | 259      |
|  |                    | fractional values of.....                          | 258      |
|  |                    | graph of.....                                      | 258      |
|  |                    | in the complex plane.....                          | 259      |
|  |                    | integer values of.....                             | 258      |
|  |                    | recurrence formulas.....                           | 258      |
|  |                    | reflection formula.....                            | 259      |



|  |                    |     |  |                    |    |
|--|--------------------|-----|--|--------------------|----|
| series expansions for .....                            | Page               | 259 | Kummer's transformation of .....                       | Page               | 16 |
| tables of .....  | 267, 272, 276, 288 |     | Lagrange's expansion .....                             | 14                 |    |
| zeros of .....   | 259                |     | logarithmic .....                                      | 68                 |    |
| <b>Q</b>   |                    |     |  |                    |    |
| Quadratic equation, solution of .....                  | 17, 19             |     | operations with .....                                  | 15                 |    |
| Quartic equation, resolution into quadratic factors .. | 17, 20             |     | reversion of .....                                     | 16                 |    |
| <b>R</b>   |                    |     |  |                    |    |
| Radau's integration formula .....                      | 888                |     | Taylor's .....   | 14                 |    |
| Random deviates, generation of .....                   | 949                |     | trigonometric .....                                    | 74                 |    |
| Random numbers .....                                   | 949                |     | Shifted Chebyshev polynomials .....                    | 774                |    |
| methods of generation of .....                         | 949                |     | (see orthogonal polynomials)                           |                    |    |
| table of .....   | 991                |     | Shifted Legendre polynomials .....                     | 774                |    |
| Repeated integrals of the error function .....         | 299                |     | (see orthogonal polynomials)                           |                    |    |
| as a single integral .....                             | 299                |     | Sievert integral .....                                 | 1000               |    |
| asymptotic expansion of .....                          | 300                |     | Simpson's rule .....                                   | 886                |    |
| definition .....                                       | 299                |     | Sine integral .....                                    | 231, 510           |    |
| derivatives of .....                                   | 300                |     | asymptotic expansions of .....                         | 233                |    |
| differential equation .....                            | 299                |     | computation of .....                                   | 233                |    |
| graph of .....   | 300                |     | definitions .....                                      | 231                |    |
| power series for .....                                 | 299                |     | graphs of .....  | 232                |    |
| recurrence relations .....                             | 299                |     | integral representation of .....                       | 232                |    |
| relation to Hermite polynomials .....                  | 300                |     | integrals .....  | 232                |    |
| relation to parabolic cylinder functions .....         | 300                |     | rational approximations .....                          | 233                |    |
| relation to the confluent hypergeometric func-         |                    |     | relation to exponential integral .....                 | 232                |    |
| tion .....   | 300                |     | series expansions for .....                            | 232                |    |
| relation to the $Hh$ function .....                    | 300                |     | symmetry relations .....                               | 232                |    |
| table of .....   | 317                |     | tables of .....  | 238, 243           |    |
| value at zero .....                                    | 300                |     | Skewness .....   | 928                |    |
| Representation of numbers .....                        | 1012               |     | Spence's integral .....                                | 1004               |    |
| Reversion of series .....                              | 16, 882            |     | Spherical Bessel functions .....                       | 230, 301, 435, 540 |    |
| Riccati-Bessel functions .....                         | 445                |     | addition theorems for .....                            | 440                |    |
| definitions .....                                      | 445                |     | analytic continuation of .....                         | 439                |    |
| differential equation .....                            | 445                |     | ascending series for .....                             | 437                |    |
| Wronskian relations .....                              | 445                |     | complex zeros of $h_n^{(1)}(z)$ , $h_n^{(2)}(z)$ ..... | 441                |    |
| Riemann zeta function .....                            | 256, 807           |     | computation of .....                                   | 452                |    |
| special values of .....                                | 807                |     | cross products of .....                                | 439                |    |
| Riemann's differential equation .....                  | 564                |     | definitions .....                                      | 437                |    |
| solutions of .....                                     | 564                |     | degenerate forms .....                                 | 440                |    |
| Riemann's $P$ function .....                           | 564                |     | derivatives with respect to order .....                | 440                |    |
| transformation formulas .....                          | 565                |     | differential equation .....                            | 437                |    |
| Ring functions .....                                   | 336                |     | differentiation formulas .....                         | 439                |    |
| Rodrigues' formula .....                               | 334, 773, 785      |     | duplication formula .....                              | 440                |    |
| Roots .....  |                    |     | Gegenbauer's generalization for .....                  | 438                |    |
| computation of .....                                   | 19, 89             |     | generating functions for .....                         | 439                |    |
| graph of .....   | 19                 |     | graphs of .....  | 438                |    |
| of complex numbers .....                               | 17, 20             |     | infinite series involving $j_n^2(z)$ .....             | 440                |    |
| tables of .....  | 24, 223            |     | limiting values as $z \rightarrow 0$ .....             | 437                |    |
| Runge-Kutta methods .....                              | 896                |     | modulus and phase .....                                | 439                |    |
| <b>S</b>   |                    |     |  |                    |    |
| Scales of notation .....                               | 1011               |     | Poisson's integral for .....                           | 438                |    |
| general conversion methods .....                       | 1012               |     | Rayleigh's formula for .....                           | 439                |    |
| Schwarz's inequality .....                             | 11                 |     | recurrence relations .....                             | 439                |    |
| Sectoral harmonics .....                               | 332                |     | relation to Fresnel integrals .....                    | 440                |    |
| Series .....   | 14                 |     | representations by elementary functions .....          | 437                |    |
| binomial .....   | 14                 |     | tables of .....  | 457                |    |
| Euler-Maclaurin summation formula .....                | 16, 22             |     | Wronskian relations .....                              | 437                |    |
| Euler's transformation of .....                        | 16, 21             |     | zeros and their asymptotic expansions .....            | 440                |    |
| exponential .....                                      | 69                 |     | Spherical polynomials (Legendre) .....                 | 332                |    |
|  |                    |     | (see orthogonal polynomials)                           |                    |    |
|  |                    |     | Spherical triangles, solution of .....                 | 79                 |    |
|  |                    |     | Spheroidal wave functions .....                        | 751                |    |
|  |                    |     | asymptotic behavior of .....                           | 756                |    |
|  |                    |     | asymptotic expansions of .....                         | 755                |    |

|   | Page     |   | Page          |
|---|----------|---|---------------|
| Spheroidal wave functions—Continued                 |          |   |               |
| characteristic values for                           | 753, 756 | Thiele's interpolation formula  | 881           |
| differential equations                              | 753      | Toroidal functions  | 336           |
| evaluation of coefficients for                      | 755      | Toronto function  | 509           |
| expansions for                                      | 755      | Trapezoidal rule  | 885           |
| joining factors for                                 | 757      | Triangle inequality   | 11            |
| normalization of                                    | 755      | Trigamma function   | 260           |
| tables of   | 766      | (see polygamma functions)   |               |
| table of eigenvalues of                             | 760      | Trigonometric functions   | 71            |
| table of prolate joining factors                    | 769      | (see circular functions)  |               |
| Stirling numbers                                    | 824      | Truncated exponential function  | 70, 262       |
| table of the first kind                             | 833      |   |               |
| table of the second kind                            | 835      | U   |               |
| Stirling's formula                                  | 257      | Ultraspherical polynomials  | 774           |
| Struve's functions                                  | 495      | (see orthogonal polynomials)  |               |
| asymptotic expansions for large orders              | 498      | coefficients for and $x^n$ in terms of  | 794           |
| asymptotic expansions for large $ z $               | 497, 498 | graphs of   | 776           |
| computation of                                      | 499      | Unit step function  | 1020          |
| differential equation                               | 496      |   |               |
| graphs of   | 496      | V   |               |
| integral representations of                         | 496, 498 | Variance  | 928           |
| integrals   | 497, 498 | Variance-ratio distribution function  | 946           |
| modified  | 498      | (see $F$ -distribution function)  |               |
| power series expansion for                          | 496, 498 | Vector-addition coefficients  | 1006          |
| recurrence relations                                | 496, 498 |   |               |
| relation to Weber's function                        | 498      | W   |               |
| special properties of                               | 497      | Wallis' formula   | 258           |
| tables of   | 501      | Wave equation   |               |
| Student's $t$ -distribution                         | 948      | in prolate and oblate spheroidal coordinates                                  | 752           |
| approximations to                                   | 949      | Weber's function  | 498           |
| asymptotic expansion of                             | 949      | relation to Anger's function  | 498           |
| limiting distribution                               | 949      | relation to Struve's function   | 498           |
| non-central   | 949      | Weierstrass elliptic functions  | 627           |
| series expansions for                               | 948      | addition formulas for   | 635           |
| statistical properties of                           | 948      | case $\Delta = 0$   | 651           |
| Subtabulation                                       | 881      | computation of  | 663           |
| Summable series                                     | 1005     | conformal mapping of  | 642, 654, 659 |
| Summation of rational series                        | 264      | definitions   | 629           |
| Sums of positive powers                             | 813      | derivatives of  | 640           |
| Sums of powers                                      | 804      | determination of periods from given invariants                                | 665           |
| Sums of reciprocal powers                           | 807, 811 | determination of values at half-periods, etc., from                           |               |
| Systems of differential equations of first order    | 897      | given periods   | 664           |
|   |          | differential equation   | 629, 640      |
| T   |          | discriminant  | 629           |
| Taylor expansion                                    | 880      | equianharmonic case   | 652           |
| Taylor's formula                                    | 14       | expressing any elliptic function in terms of $\mathcal{P}$ and $\mathcal{P}'$ | 651           |
| Tesseral harmonics                                  | 332      | fundamental period parallelogram  | 629           |
| Tetrachoric functions                               | 934      | fundamental rectangle   | 630           |
| Tetragamma function                                 | 260      | homogeneity relations   | 631           |
| (see polygamma functions)                           |          | integrals   | 641           |
| Theta functions                                     | 576      | invariants  | 629           |
| addition of quarter-periods                         | 577      | Legendre's relation   | 634           |
| calculation by use of the arithmetic-geometric mean | 577, 580 | lemniscatic case  | 658           |
| expansions in terms of the nome $q$                 | 576      | maps of   | 642, 654, 659 |
| Jacobi's notation for                               | 577      | multiplication formulas   | 635           |
| logarithmic derivatives of                          | 576      | other series involving $\mathcal{P}$ , $\mathcal{P}'$ , $\zeta$               | 639           |
| logarithms of sum and difference                    | 577      | pseudo-lemniscatic case   | 662           |
| Neville's notation for                              | 578, 582 | reduction formulas  | 631           |
| relations between squares of the functions          | 576      | relation with complete elliptic integrals                                     | 649           |
| relation to Jacobi's zeta function                  | 578      | relations with Jacobi's elliptic functions                                    | 649           |
| relation with Weierstrass elliptic functions        | 650      | relations with theta functions  | 650           |

|  | Page |                          | Page     |
|--|------|--------------------------|----------|
| reversed series for large $ \mathcal{P} ,  \mathcal{P}' ,  \zeta $ ----- | 638  | Whittaker functions----- | 505      |
| reversed series for small $ \sigma $ -----                               | 640  | Wigner coefficients----- | 1006     |
| series expansions for-----   | 635  |                          |          |
| special values and relations-----  | 633  | <b>Z</b>                 |          |
| symbolism-----   | 629  | Zeta function            |          |
| tables of-----   | 673  | Jacobi's-----            | 578      |
|  |      | Riemann's-----           | 256, 807 |

# Index of Notations

|  | Page |  | Page     |
|--|------|--|----------|
| $(a)_n = \Gamma(a+n)/\Gamma(a)$ (Pochhammer's symbol) .....                    | 256  | Ei(x) exponential integral .....   | 228      |
| $a_r(q)$ characteristic value of Mathieu's equation .....                      | 722  | $E_1(z)$ exponential integral .....  | 228      |
| $A(x) = 2P(x) - 1$ normal probability function .....                           | 931  | $E[g(X)]$ expected value operator for the function<br>$g(x)$ .....   | 928      |
| Ai(z) Airy function .....  | 446  | $E_{in}(z)$ modified exponential integral .....  | 228      |
| A.G.M. arithmetic-geometric mean .....   | 571  | $E_n$ Euler number .....   | 804      |
| am $z$ amplitude of the complex number $z$ .....                               | 16   | $E_n(x)$ Euler polynomial .....  | 804      |
| antilog antilogarithm ( $\log^{-1}$ ) .....                                    | 89   | $E_n(z)$ exponential integral .....  | 228      |
| arcsin $z$ , arccos $z$ inverse circular functions .....                       | 79   | erf $z$ error function .....   | 297      |
| arctan $z$ , arccot $z$  |      | erfc $z$ complementary error function .....  | 297      |
| arcsec $z$ , arccsc $z$  |      | exp $z = e^z$ exponential function .....   | 69       |
| arsinh $z$ , arccosh $z$ inverse hyperbolic functions .....                    | 86   | exsec $A$ , exsecant $A$ .....   | 78       |
| arctanh $z$ , arccoth $z$  |      | $f_{e,r}, f_{o,r}$ joining factors for Mathieu functions .....   | 735      |
| arcsech $z$ , arccsch $z$  |      | $F(a, b; c; z)$ hypergeometric function .....  | 556      |
| arg $z$ argument of $z$ .....  | 16   | $F(\varphi \setminus \alpha)$ elliptic integral of the first kind .....  | 589      |
| $b_r(q)$ characteristic value of Mathieu's equation .....                      | 722  | $F_L(\eta, \rho)$ Coulomb wave function (regular) .....  | 538      |
| $B_n$ Bernoulli number .....   | 804  | FPP fundamental period parallelogram .....   | 629      |
| $B_n(x)$ Bernoulli polynomial .....  | 804  | ${}_nF_m(a_1, \dots, a_n; b_1, \dots, b_m; z)$ generalized hyper-<br>geometric function .....                  | 556      |
| ber $_x$ , bei $_x$ , Kelvin functions .....                                   | 379  | $g_2, g_3$ invariants of Weierstrass elliptic functions .....  | 629      |
| Bi(z) Airy function .....  | 446  | $g_{e,r}, g_{o,r}$ joining factors for Mathieu functions .....   | 740      |
| cd, sd, nd Jacobian elliptic functions .....                                   | 570  | $g(x, y, \rho)$ bivariate normal probability function .....  | 936      |
| c.d.f. cumulative distribution function .....                                  | 927  | Gi(z) related Airy function .....  | 448      |
| $ce_r(z, q)$ Mathieu function .....  | 725  | $G_L(\eta, \rho)$ Coulomb wave function (irregular or loga-<br>rithmic) .....                                  | 538      |
| cn Jacobian elliptic function .....  | 569  | $G_n(p, q, x)$ Jacobi polynomial .....   | 774      |
| Cn, Dn, Sn integrals of the squares of Jacobian<br>elliptic functions .....    | 576  | gd(z) Gudermannian .....   | 77       |
| cs, ds, ns Jacobian elliptic functions .....                                   | 570  | $h_n^{(3)}(z)$ spherical Bessel function of the third kind .....   | 437      |
| $C(x)$ Fresnel integral .....  | 300  | hav $A$ haversine $A$ .....  | 78       |
| $C_n(x)$ Chebyshev polynomial of the second kind .....                         | 774  | $H_r(z)$ Struve's function .....   | 496      |
| $C(x, a)$ generalized Fresnel integral .....                                   | 262  | Hi(z) related Airy function .....  | 448      |
| $Ce_r(z, q)$ modified Mathieu function .....                                   | 732  | $He_n(z)$ Hermite polynomial .....   | 775      |
| $C_1(z), C_2(z)$ Fresnel integrals .....                                       | 300  | $H_n^{(3)}(z)$ Bessel function of the third kind (Hankel) .....  | 358      |
| $C_n^{(\omega)}(x)$ ultraspherical (Gegenbauer) polynomial .....               | 774  | $Hh_n(x)$ (probability) function .....   | 300, 691 |
| Chi(z) hyperbolic cosine integral .....  | 231  | $H_n(x)$ Hermite polynomial .....  | 775      |
| Ci(z) cosine integral .....  | 231  | $H(m, n, x)$ confluent hypergeometric function .....   | 695      |
| Cinh(z) hyperbolic cosine integral .....                                       | 231  | $I_r(z)$ modified Bessel function .....  | 374      |
| colog cologarithm .....  | 89   | $\sqrt{\frac{1}{2}\pi/z} I_{n+\frac{1}{2}}(z)$ modified spherical Bessel function<br>of the first kind .....   | 443      |
| covers $A$ , coversine $A$ .....   | 78   | $\sqrt{\frac{1}{2}\pi/z} I_{-n-\frac{1}{2}}(z)$ modified spherical Bessel function<br>of the second kind ..... | 443      |
| dc, nc, sc Jacobian elliptic functions .....                                   | 570  | $I(u, p)$ incomplete gamma function (Pearson's<br>form) .....  | 262      |
| dn = $\Delta(\varphi)$ delta amplitude (Jacobian elliptic func-<br>tion) ..... | 569  | $I_x(a, b)$ incomplete beta function .....   | 263      |
| $D_r(x)$ parabolic cylinder function (Whittaker's<br>form) .....               | 687  | $\Im z$ imaginary part of $z (= y)$ .....  | 16       |
| $e_1, e_2, e_3$ roots of a polynomial (Weierstrass form) .....                 | 629  | $i^n$ erfc $z$ repeated integral of the error function .....   | 299      |
| $e^z$ exponential function .....   | 69   | $j_n(z)$ spherical Bessel function of the first kind .....   | 437      |
| $e_n(z)$ truncated exponential function .....                                  | 262  | $\mathbf{J}_r(z)$ Anger's function .....   | 498      |
| $E(\varphi \setminus \alpha)$ elliptic integral of the second kind .....       | 589  | $J_r(z)$ Bessel function of the first kind .....   | 358      |
| $E(a, x)$ parabolic cylinder function .....                                    | 693  | $k$ modulus of Jacobian elliptic functions .....   | 590      |
| $\mathbf{E}_r(z)$ Weber's function .....                                       | 498  | $k'$ complementary modulus .....   | 590      |
| $E_r^{(m)}(z)$ Weber parabolic cylinder function .....                         | 509  | $k_r(z)$ Bateman's function .....  | 510      |
| $E(m)$ complete elliptic integral of the second<br>kind .....                  | 590  |  |          |

|  | Page     |   | Page |
|--|----------|---|------|
| $Ki(z)$ repeated integrals of $K_0(z)$ .....   | 483      | $q(n)$ number of partitions into distinct integer summands.....     | 825  |
| $\sqrt{\frac{1}{2}\pi/z} K_{n+\frac{1}{2}}(z)$ modified spherical Bessel function of the third kind..... | 443      | $Q_n^\mu(z)$ associated Legendre function of the second kind.....   | 332  |
| $K_\nu(z)$ modified Bessel function.....   | 374      | $Q_n(x)$ Legendre function of the second kind.....                  | 334  |
| $K(m)$ complete elliptic integral of the first kind.....   | 590      | $\Re z$ real part of $z(=x)$ .....                                  | 16   |
| $\ker_x, \text{kei}_x$ Kelvin functions.....   | 379      | $R_l^{(2)}(c, \xi)$ radial spheroidal wave function.....            | 753  |
| $li(x)$ logarithmic integral.....  | 228      | $S_n^{(m)}$ Stirling number of the first kind.....                  | 824  |
| $\lim$ limit.....  | 13       | $\mathfrak{S}_n^{(m)}$ Stirling number of the second kind.....      | 824  |
| $\log_{10} x$ common (Briggs) logarithm.....   | 68       | $se_r(z, q)$ Mathieu function.....                                  | 725  |
| $\log_a z$ logarithm of $z$ to base $a$ .....  | 67       | $sn$ Jacobian elliptic function.....                                | 569  |
| $\ln z (= \log_e z)$ natural, Napierian or hyperbolic logarithm.....                                     | 68       | $S(z)$ Fresnel integral.....  | 300  |
| $\mathcal{L}[F(t)] = f(s)$ Laplace transform.....  | 1020     | $S_1(z), S_2(z)$ Fresnel integrals.....                             | 300  |
| $L(h, k, \rho)$ cumulative bivariate normal probability function.....                                    | 936      | $Se_r(z, q)$ modified Mathieu function.....                         | 733  |
| $L_n(x)$ Laguerre polynomial.....  | 775      | $S(x, a)$ generalized Fresnel integral.....                         | 262  |
| $L_n^{(\alpha)}(x)$ generalized Laguerre polynomial.....   | 775      | $Shi(z)$ hyperbolic sine integral.....                              | 231  |
| $\mathbf{L}_\nu(z)$ modified Struve function.....  | 498      | $Si(z)$ sine integral.....  | 231  |
| $m = \mu_1'$ mean.....   | 928      | $S_n(x)$ Chebyshev polynomial of the first kind.....                | 774  |
| $m$ parameter (elliptic functions).....  | 569      | $Sih(z)$ hyperbolic sine integral.....                              | 231  |
| $m_1$ complementary parameter.....   | 569      | $S_l^{(2)}(c, \eta)$ angular spheroidal wave function.....          | 753  |
| $M(a, b, z)$ Kummer's confluent hypergeometric function.....   | 504      | $si(z)$ sine integral.....  | 232  |
| $Mc_r^{(j)}(z, q)$ modified Mathieu function.....  | 733      | $\sin z, \cos z, \tan z$ circular functions.....                    | 71   |
| $Ms_r^{(j)}(z, q)$ modified Mathieu function.....  | 733      | $\cot z, \sec z, \csc z$ .....                                      | 72   |
| $M_{\nu, \mu}(z)$ Whittaker function.....  | 505      | $\sinh z, \cosh z, \tanh z$ hyperbolic functions.....               | 83   |
| $n$ characteristic of the elliptic integral of the third kind.....                                       | 590      | $\coth z, \text{sech } z, \text{csch } z$ .....                     | 83   |
| $O(v_n) = u_n, u_n$ is of the order of $v_n$ ( $u_n/v_n$ is bounded).....                                | 15       | $T(m, n, r)$ Toronto function.....                                  | 509  |
| $o(v_n) = u_n, \lim_{n \rightarrow \infty} \frac{u_n}{v_n} = 0$ .....                                    | 259      | $T_n(x)$ Chebyshev polynomial of the first kind.....                | 774  |
| $O_n(z)$ Neumann's polynomial.....   | 363      | $T_n^*(x)$ shifted Chebyshev polynomial of the first kind.....      | 774  |
| $p(n)$ number of partitions.....   | 825      | $U(a, b, z)$ Kummer's confluent hypergeometric function.....        | 504  |
| $\mathcal{P}(z)$ Weierstrass elliptic function.....  | 629      | $U_n(x)$ Chebyshev polynomial of the second kind.....               | 774  |
| $\text{ph } z$ phase of the complex number $z$ .....   | 16       | $U_n^*(x)$ shifted Chebyshev polynomial of the second kind.....     | 774  |
| $P(a, x)$ incomplete gamma function.....   | 260      | $U(a, x)$ Weber parabolic cylinder function.....                    | 687  |
| $P(\chi^2 \nu)$ probability of the $\chi^2$ -distribution.....   | 262, 940 | $\text{vers } A, \text{versine } A$ .....                           | 78   |
| $P_\nu^\mu(z)$ associated Legendre function of the first kind.....                                       | 332      | $V(a, x)$ Weber parabolic cylinder function.....                    | 687  |
| $P(x)$ normal probability function.....  | 931      | $w(z)$ error function.....  | 297  |
| $P_n(z)$ Legendre function (spherical polynomials).....  | 333, 774 | $W(a, x)$ Weber parabolic cylinder function.....                    | 692  |
| $P_n^*(x)$ shifted Legendre polynomial.....  | 774      | $W_{\kappa, \mu}(z)$ Whittaker function.....                        | 505  |
| $P_n^{(\alpha, \beta)}(x)$ Jacobi polynomial.....  | 774      | $W\{f(x), g(x)\} (= f(x)g'(x) - f'(x)g(x))$ Wronskian relation..... | 505  |
| $Pr\{X \leq x\}$ probability of the event $X \leq x$ .....   | 927      | $[x_0, x_1, \dots, x_k]$ divided difference.....                    | 877  |
| $q$ nome.....  | 591      | $y_n(z)$ spherical Bessel function of the second kind.....          | 437  |
| $Q(x) = 1 - P(x)$ normal probability function (tail area).....   | 931      | $Y_\nu(z)$ Bessel function of the second kind.....                  | 358  |
|  |          | $Y_n^*(\theta, \varphi)$ surface harmonic of the first kind.....    | 332  |
|  |          | $Z(x)$ normal probability density function.....                     | 931  |



## Notation — Greek Letters

|   | Page |  | Page |
|---|------|--|------|
| $\alpha$ modular angle (elliptic function) .....  | 590  | $\Theta(u m)$ Jacobi's theta function .....                                  | 577  |
| $\alpha_n(z) = \int_1^\infty t^n e^{-st} dt$ .....  | 228  | $\kappa_n$ $n$ th cumulant .....   | 928  |
| $\beta_n(z) = \int_{-1}^1 t^n e^{-st} dt$ .....   | 228  | $\kappa_{mn}^{(p)}$ joining factor for spheroidal wave functions ..          | 757  |
| $\beta(n) = \sum_{k=0}^{\infty} (-1)^k (2k+1)^{-n}$ .....   | 807  | $\lambda(n) = \sum_{k=0}^{\infty} (2k+1)^{-n}$ .....                         | 807  |
| $B_x(a, b)$ incomplete beta function .....  | 263  | $\lambda_{mn}$ characteristic value of the spheroidal wave equation .....    | 753  |
| $B(z, w)$ beta function .....   | 258  | $\Lambda_0(\varphi \setminus \alpha)$ Heuman's lambda function .....         | 595  |
| $\gamma$ Euler's constant .....   | 255  | $\mu(f_n)$ mean difference .....   | 877  |
| $\gamma(a, x)$ incomplete gamma function (normalized) ..  | 260  | $\mu(n)$ Möbius function .....   | 826  |
| $\gamma_1 = \frac{\mu_3}{\sigma_3}$ coefficient of skewness .....   | 928  | $\mu_n$ $n$ th central moment .....  | 928  |
| $\gamma_2 = \frac{\mu_4}{\sigma^4} - 3$ coefficient of excess .....   | 928  | $\mu'_n$ $n$ th moment about the origin .....                                | 928  |
| $\Gamma(z)$ gamma function .....  | 255  | $\pi(x)$ number of primes $\leq x$ .....                                     | 231  |
| $\Gamma(a, x)$ incomplete gamma function .....  | 260  | $\pi_n(x) = (x-x_0)(x-x_1) \dots (x-x_n)$ .....                              | 878  |
| $\delta_{ij}$ Kronecker delta (=0 if $i \neq j$ ; =1 if $i=j$ ) .....                                       | 822  | $\Pi(n; \varphi \setminus \alpha)$ elliptic integral of the third kind ..... | 590  |
| $\delta_n^k(f_n)$ central difference .....  | 877  | $\Pi(z)$ factorial function .....  | 255  |
| $\Delta$ difference operator .....  | 822  | $\rho$ correlation coefficient .....   | 936  |
| $\Delta$ discriminant of Weierstrass' canonical form .....  | 629  | $\rho_n(x_0, x_1, \dots, x_n)$ reciprocal difference .....                   | 878  |
| $\Delta(f_n)$ forward difference .....  | 877  | $\rho_n(\nu, x)$ Poisson-Charlier function .....                             | 509  |
| $\Delta x$ absolute error .....   | 14   | $\sigma$ standard deviation .....  | 298  |
| $\zeta(x)$ Riemann zeta function .....  | 807  | $\sigma^2$ variance .....  | 928  |
| $\zeta(z)$ Weierstrass zeta function .....  | 629  | $\sigma(z)$ Weierstrass sigma function .....                                 | 629  |
| $Z(u m)$ Jacobi's zeta function .....   | 578  | $\sigma_k(n)$ divisor function .....   | 827  |
| $\eta(n) = \sum_{k=1}^{\infty} (-1)^{k-1} k^{-n}$ .....   | 807  | $\tau_n(x)$ tetrahoric function .....  | 934  |
| $\eta_a = \zeta(\omega_a)$ Weierstrass elliptic function .....  | 631  | $\varphi = \text{am } u$ , amplitude .....                                   | 569  |
| $H(u), H_1(u)$ Jacobi's eta function .....  | 577  | $\varphi(n)$ Euler-Totient function .....                                    | 826  |
| $\vartheta_n(z)$ theta function .....   | 576  | $\varphi(t) = E(e^{itX})$ characteristic function of $X$ .....               | 928  |
| $\vartheta_c(\epsilon \setminus \alpha), \vartheta_d(\epsilon \setminus \alpha)$ , Neville's notation ..... | 578  | $\Phi(a; b; z)$ confluent hypergeometric function .....                      | 504  |
| $\vartheta_n(\epsilon \setminus \alpha), \vartheta_s(\epsilon \setminus \alpha)$ theta functions            |      | $\psi(z)$ logarithmic derivative of the gamma function .....                 | 258  |
|   |      | $\Psi(a; c; z)$ confluent hypergeometric function .....                      | 504  |
|   |      | $\omega_a$ period of Weierstrass elliptic functions .....                    | 629  |
|   |      | $\omega_{\kappa, \mu}(x)$ Cunningham function .....                          | 510  |

## Miscellaneous Notations

|   | Page |   | Page |
|---|------|---|------|
| $[a_{ik}]$ determinant .....  | 19   | $\langle x \rangle$ nearest integer to $x$ .....                                    | 222  |
| $[a_i]$ column matrix .....   | 19   | $\bar{z}$ complex conjugate of $z (=x-iy)$ .....                                    | 16   |
| $\nabla^n$ Laplacian operator .....   | 752  | $z = x+iy$ complex number (Cartesian form) .....                                    | 16   |
| $\Delta_n^k$ forward difference operator .....  | 877  | $= re^{i\theta}$ (polar form) .....   | 16   |
| $\frac{\partial}{\partial z}$ partial derivative .....  | 883  | $ z $ absolute value or modulus of $z$ .....  | 16   |
| $i$ ( $= \sqrt{-1}$ ) .....   | 70   | $\Sigma$ overall summation .....  | 822  |
| $\binom{n}{r}$ binomial coefficient .....   | 10   | $\Sigma'$ restricted summation .....  | 755  |
| $n!$ factorial function .....   | 255  | $\Sigma \Pi$ sum or product taken over all prime numbers $p$ ..                     | 807  |
| $(2n)!! = 2 \cdot 4 \cdot 6 \dots (2n) = 2^n n!$ .....  | 258  | $\sum_{p n} \prod_{d p} \Pi$ sum or product overall positive divisors $d$ of $n$ .. | 826  |
| $(m, n)$ greatest common divisor .....  | 822  | $\int$ Cauchy's principal value of the integral .....                               | 228  |
| $(n, k) = \frac{\Gamma(\frac{1}{2} + n + k)}{k! \Gamma(\frac{1}{2} + n - k)}$ (Hankel's symbol) ..... | 437  | $\approx$ approximately equal .....   | 14   |
| $(n; n_1, n_2, \dots, n_m)$ multinomial coefficient .....   | 823  | $\sim$ asymptotically equal .....   | 15   |
| $[x]$ largest integer $\leq x$ .....  | 66   | $<, >, \leq, \geq$ inequality, inclusion .....                                      | 10   |
|   |      | $\neq$ unequal .....  | 12   |